



NEW COMBO LIFE

Price and Specification Guide | 7 June 2018 | Model Year 2019 UPDATED RELEASE



VAUXHALL
British Brand since 1903



CONTENTS

RANGE HIGHLIGHTS

Explore the Combo Life range and find your perfect model.

MODELS

Find all the information you need about your chosen model.

PRICES

Find on-the-road recommended retail prices.

FEATURES/OPTIONS

Tailor your chosen model to suit your needs with everything from a satellite navigation to rear-view camera and parking sensors.

EXTERIOR COLOURS

Add some sparkle to your car with a metallic paint.

WHEELS AND TYRES

Why not upgrade to a set of distinctive alloy wheels to give your car more presence.

PERFORMANCE, FUEL ECONOMY AND EMISSIONS

Know how many miles you will get around town, the CO₂ figures and the 0–60 time.

DIMENSIONS

Ensure your car will fit in the garage and know how much luggage you can take for a long weekend away.

SPECIFICATIONS

Towing weights, engine details and other useful details you may need to know.

COMPANY CAR INFORMATION

Benefit in Kind company car tax, 3 day test drives and P11D.

FURTHER INFORMATION

Insurance groups, vehicle excise duty, our range of additional products and much more.



COMBO LIFE RANGE HIGHLIGHTS



DESIGN OTR from £19,610

Standard features include:

Exterior:

- Electrically adjustable / heated door mirrors
- Electrically operated front windows
- Nearside and offside sliding side-access door with opening windows
- Daytime running lights
- Tailgate with heated rear window and wiper
- Body-colour front and rear bumpers
- Side protection mouldings
- Emergency tyre inflation kit

Interior:

- Height-adjustable driver's seat
- 60/40 split-folding rear seat back
- Air conditioning
- Steering wheel mounted audio controls
- 3.5-inch colour display

Infotainment:

- AM/FM/DAB digital radio, Bluetooth®, USB audio connection with four speakers

Safety / security:

- Automatic emergency braking with pedestrian detection
- Electronic stability programme with traction control
- Forward collision alert
- Lane keep assist with lane departure warning
- Automatic lighting control
- Keyless entry and start (on automatic models)
- Cruise control with speed limiter
- Speed sign recognition
- Six airbags
- Driver drowsiness system

ENERGY OTR from £21,010

Features over Design:

Exterior:

- Body-colour exterior door mirrors and handles
- Front and rear parking sensors
- Front fog lights
- 16-inch alloy wheels with 205/60 R16 tyres
- Automatic windscreen wipers
- High beam assist
- Body-colour side protection mouldings

Interior:

- Chrome-effect instrument rings
- Chrome-effect interior door handles

Infotainment:

- Touchscreen infotainment system
- 8-inch colour touchscreen

7-SEAT OTR from £21,710

7-seat models additionally feature:

- 35/30/35 split-folding second-row seats with fold-flat facility
- Two individual split-folding and removable third-row seats
- Sliding facility for third row seats (XL models only)
- Front-seat back pockets
- Two foldable tables with cupholders

KEY OPTIONS Total inc. VAT

Looking good:	
Brilliant paint	£285
Metallic / pearlescent paint	£565
Easier parking:	
Parking Pack	from £400
Winter warming:	
Winter Pack	£200
Driving assistance:	
Advanced park assist	£200
Satellite Navigation systems	from £450
Practicality:	
Full-length panoramic glass sunroof	£840
All-weather Pack	£410
Wireless charger for mobile devices	£105
Child Pack	£250
Tow bar	£500
Roof rails	£150



DESIGN



DESIGN ON-THE-ROAD PRICES

		OTR RRP	CO ₂ (g/km)
Petrol	1.2 (110PS) Turbo S/S	£19,610	125
Diesel	1.5 (100PS) Turbo D S/S BlueInjection	£20,140	111
	1.5 (130PS) Turbo D S/S BlueInjection automatic	£22,660	113

DESIGN XL ON-THE-ROAD PRICES

		OTR RRP	CO ₂ (g/km)
Petrol	1.2 (110PS) Turbo S/S	£20,510	125
Diesel	1.5 (100PS) Turbo D S/S BlueInjection	£21,040	114

Please note: On-the-road recommended retail prices (RRP) include VAT at 20%, number plates and delivery to Retailer of £700.00 (inc. £116.67 VAT), 12 months' Vehicle Excise Duty and new vehicle first registration fee of £55.00. Excludes fuel and insurance.

S/S = Start/Stop.

FEATURES

Infotainment:

- AM/FM/DAB digital radio, Bluetooth® audio streaming, Bluetooth® mobile phone portal, USB audio connection
- 3.5-inch colour display
- Four speakers

Interior convenience / styling:

- Height-adjustable driver's seat
- Air conditioning
- Steering wheel mounted audio controls
- 60/40 split-folding rear seat back

Exterior convenience / styling:

- Keyless entry and start – Standard on automatic models only.
- Electrically adjustable / heated door mirrors
- Electrically operated front windows with safety autoreverse and one-touch up/down facility
- Nearside and offside sliding side-access door with opening windows
- Daytime running lights
- Tailgate with heated rear window and wiper
- Body-colour front and rear bumpers
- Moulded side-protection mouldings
- 16-inch steel wheels with 205/60 R16 tyres
- Full-diameter wheel covers
- Emergency tyre inflation kit

Safety / security:

- Automatic emergency braking with pedestrian detection
- Electronic stability programme with traction control
- Anti-lock braking system
- Forward collision alert
- Emergency brake assist
- Lane keep assist with lane departure warning
- Automatic lighting control
- Cruise control with speed limiter
- Speed sign recognition
- Six airbags
- Driver drowsiness system



ENERGY



ENERGY ON-THE-ROAD PRICES

		5-seat MPV		7-seat MPV*	
		OTR RRP	CO ₂ (g/km)	OTR RRP	CO ₂ (g/km)
Petrol	1.2 (110PS) Turbo S/S	£21,010	125	£21,710	125
Diesel	1.5 (100PS) Turbo D S/S BlueInjection	£21,540	111	£22,240	115
	1.5 (130PS) Turbo D S/S BlueInjection	£22,660	114	-	-
	1.5 (130PS) Turbo D S/S BlueInjection automatic	£24,060	113	-	-

ENERGY XL ON-THE-ROAD PRICES

Petrol	1.2 (110PS) Turbo S/S	£21,910	125	-	-
Diesel	1.5 (100PS) Turbo D S/S BlueInjection	£22,440	114	£23,240	115

Please note: On-the-road recommended retail prices (RRP) include VAT at 20%, number plates and delivery to Retailer of £700.00 (inc. £116.67 VAT), 12 months' Vehicle Excise Duty and new vehicle first registration fee of £55.00. Excludes fuel and insurance.

S/S = Start/Stop.

FEATURES

Infotainment:

- Touchscreen infotainment system digital radio, Bluetooth® audio streaming, Bluetooth® mobile phone portal, USB audio connection
- 8-inch colour touchscreen
- Apple CarPlay™ / Android Auto™
- Six speakers

Interior convenience / styling:

- Height-adjustable driver's seat
- Air conditioning
- Steering wheel mounted audio controls
- Chrome-effect instrument rings
- Chrome-effect interior door handles
- 60/40 split-folding rear seat back (5-seat models)
- 35/30/35 split-folding second-row seats with fold-flat facility (7-seat models)
- Two individual split-folding and removable third-row seats (7-seat models)
- Sliding facility for third row seats (7-seat XL models only)
- Front-seat back pockets (7-seat models)
- Two foldable tables with cupholders (7-seat models)

Exterior convenience / styling:

- Keyless entry and start – Standard on automatic models only.
- Automatic windscreen wipers
- High beam assist
- Front and rear parking sensors

- Front fog lights
- Electrically adjustable / heated body-colour door mirrors
- Electrically operated front windows with safety autoreverse and one-touch up/down facility
- Nearside and offside sliding side-access door with opening windows
- Daytime running lights
- Tailgate with heated rear window and wiper
- Body-colour bumpers, door handles and side-access door railcovers
- Body-colour side protection mouldings
- 16-inch alloy wheels with 205/60 R16 tyres
- Emergency tyre inflation kit

Safety / security:

- Automatic emergency braking with pedestrian detection
- Electronic stability programme with traction control
- Anti-lock braking system
- Forward collision alert
- Emergency brake assist
- Lane keep assist with lane departure warning
- Automatic lighting control
- Cruise control with speed limiter
- Speed sign recognition
- Six airbags
- Driver drowsiness system



COMBO LIFE PRICES

	Fuel Type	Price (£)	VAT (£)	Total (£)	On-the-road RRP (£)	CO ₂ (g/km)
DESIGN						
1.2 (110PS) Turbo S/S	Petrol	15,575.00	3,115.00	18,690.00	19,610.00	125
1.5 (100PS) Turbo D S/S BlueInjection	Diesel	15,983.33	3,196.67	19,180.00	20,140.00	111
1.5 (130PS) Turbo D S/S BlueInjection automatic	Diesel	18,083.33	3,616.67	21,700.00	22,660.00	113
DESIGN XL						
1.2 (110PS) Turbo S/S	Petrol	16,325.00	3,265.00	19,590.00	20,510.00	125
1.5 (100PS) Turbo D S/S BlueInjection	Diesel	16,733.33	3,346.67	20,080.00	21,040.00	114
ENERGY						
1.2 (110PS) Turbo S/S	Petrol	16,741.67	3,348.33	20,090.00	21,010.00	125
1.5 (100PS) Turbo D S/S BlueInjection	Diesel	17,150.00	3,430.00	20,580.00	21,540.00	111
1.5 (130PS) Turbo D S/S BlueInjection	Diesel	18,083.33	3,616.67	21,700.00	22,660.00	114
1.5 (130PS) Turbo D S/S BlueInjection automatic	Diesel	19,250.00	3,850.00	23,100.00	24,060.00	113
ENERGY (7-seat)						
1.2 (110PS) Turbo S/S	Petrol	17,325.00	3,465.00	20,790.00	21,710.00	125
1.5 (100PS) Turbo D S/S BlueInjection	Diesel	17,733.33	3,546.67	21,280.00	22,240.00	115
ENERGY XL						
1.2 (110PS) Turbo S/S	Petrol	17,491.67	3,498.33	20,990.00	21,910.00	125
1.5 (100PS) Turbo D S/S BlueInjection	Diesel	17,900.00	3,580.00	21,480.00	22,440.00	114
ENERGY XL (7-seat)						
1.5 (100PS) Turbo D S/S BlueInjection	Diesel	18,566.67	3,713.33	22,280.00	23,240.00	115

S/S = Start/Stop.

Please note: On-the-road recommended retail prices (RRP) include number plates and delivery to Retailer of £700.00 (inc. £116.67 VAT), 12 months' Vehicle Excise Duty and new vehicle first registration fee of £55.00. Excludes fuel and insurance.



FEATURES/OPTIONS

SAFETY

	Option Code	Design	Energy	Price (£) exc. VAT	Price (£) inc. VAT
Driver / passenger airbags <ul style="list-style-type: none"> • Driver's airbag • Front passenger's airbag • Two front seat side-impact airbags • Full-size curtain airbags for driver and front and outer rear seat passengers 		●	●		
Seatbelts <ul style="list-style-type: none"> • Lap and diagonal inertia-reel seatbelts (height-adjustable front) • Front body-lock diagonal seatbelt pretensioner system – Tightens the seatbelt during the early stages of a frontal impact. • Drivers and front passenger's lap belt pretensioner system • Front seatbelt force limiters – Reduces potential upper body injuries during a frontal impact • Anti-submarining ramps in front seats – Help prevent occupants sliding underneath the lap belt during a collision • 'Seatbelt unfastened' audible warning and warning light. 		●	●		
Child safety <ul style="list-style-type: none"> • Deactivation switch for front passenger's front and side-impact airbags – Permits the safe use of a child seat in the front passenger seat. • ISOFIX child seat mountings incorporating top tether anchor points located on second-row rear seats (does not include child seat) – Allows ISOFIX child safety seats to be securely fixed into the car. The ISOFIX mounting system reduces forward movement in an accident and makes the child seat easier to install. • Child-proof locks on rear doors 		●	●		
Driver / passenger safety <ul style="list-style-type: none"> • Energy-absorbing steering column • Side-impact protection beams • Reinforced passenger safety cell • Deformation zones front and rear 		●	●		
Braking and stability <ul style="list-style-type: none"> • Electronic stability programme • Anti-lock braking system • Corner stability control • Traction control • Hill start assist • Engine drag torque control – Improves directional stability by preventing the driven wheels from locking on slippery surfaces under the influence of engine braking. • Emergency brake assist • Electronic brakeforce distribution 		●	●		
Tyre pressure <ul style="list-style-type: none"> • Deflation detection system 		●	●		

FEATURES/OPTIONS

DRIVER ASSISTANCE

	Option Code	Design	Energy	Price (£) exc. VAT	Price (£) inc. VAT
<p>Mechanical parking brake</p> <ul style="list-style-type: none"> Floor-mounted handbrake lever 		●	●		
<p>Cruise control with speed limiter and intelligent speed adaptation</p> <p>The cruise control feature enables you to maintain a constant speed – making it ideal for economical motorway driving. The speed limiter function can be set to ensure that you do not exceed the speed limit and can be easily overridden if required. Working in conjunction with speed sign recognition, when a new speed limit is detected a message appears in the driver information display. You can then set the cruise control to the new speed limit with a simple press on a steering wheel button.</p>		●	●		
<p>Front camera system</p> <p>A range of class-leading driver assistance and safety features are controlled by the front camera system.</p>					
<p>Lane keep assist with lane departure warning</p> <p>If the driver has not actively steered or signalled, the lane departure warning system provides gentle steering correction and warns when the car moves outside of lane markings at speeds above 40mph.</p> <ul style="list-style-type: none"> Warning light in instrument cluster Audible warning Facia on/off switch 		●	●		
<p>Speed sign recognition</p> <p>Detects and then displays speed limits, reducing uncertainty and the risk of speeding.</p> <ul style="list-style-type: none"> Recognises different speed signs, including temporary speed restrictions Displays reminder in the instrument cluster 					
<p>Driver drowsiness system</p> <p>The system monitors driving time and driving behaviour to help prevent accidents caused by tiredness.</p>		●	●		
<p>Forward collision alert</p> <p>The system operates automatically from 3mph and gives an audible warning as well as a visual warning when approaching another vehicle too quickly.</p>		●	●		

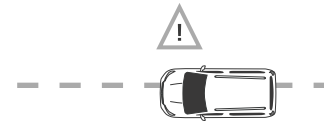
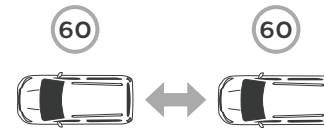



FEATURES/OPTIONS

DRIVER ASSISTANCE CONTINUED

	Option Code	Design	Energy	Price (£) exc. VAT	Price (£) inc. VAT
<p>Automatic emergency braking with pedestrian detection</p> <p>The system works automatically in conjunction with forward collision alert, at speeds between 3mph and 70mph, and detects both vehicles and pedestrians. If no avoiding action is taken by the driver, at speeds below 19mph the system automatically slows the vehicle to a full stop with emergency braking of 0.9g. At speeds from 19mph to 70mph it brakes automatically to reduce speed by a maximum of 30mph – To reduce speed even further the driver must brake him/herself. The operational speed range of the system depends on the detected obstacle (mobile target: from 3 to 53mph; fixed target: from 3 to 70mph; pedestrian: from 3 to 37mph). Vauxhall driver assistance systems are intended to support the driver within the system-imminent limitations. The driver remains responsible for the driving task.</p>		●	●		
<p>Parking sensors</p> <ul style="list-style-type: none"> • Front and rear parking distance sensors with audible warning 			●		
<ul style="list-style-type: none"> • Rear parking distance sensors with audible warning 	UD7	○	●	166.67	200.00
<p>Parking Pack – Design</p> <p>Intelligent ultrasonic sensors form part of the solution for today's crowded roads and car parks – Delivering exceptional assistance both when parking and protecting you on the open road.</p> <p>– Only available in conjunction with optional navigation unit.</p> <ul style="list-style-type: none"> • Front and rear parking distance sensors • 180° panoramic rear-view camera • Side blind spot alert • Electrically foldable door mirrors • Front fog lights with cornering light function 	XIEE	○		750.00	900.00
<p>Parking Pack – Energy</p> <p>Intelligent ultrasonic sensors form part of the solution for today's crowded roads and car parks – Delivering exceptional assistance both when parking and protecting you on the open road.</p> <p>– Only available in conjunction with optional navigation unit.</p> <ul style="list-style-type: none"> • 180° panoramic rear-view camera • Side blind spot alert • Electrically foldable door mirrors 	XIEE		○	333.33	400.00

FEATURES/OPTIONS

DRIVER ASSISTANCE CONTINUED

	Option Code	Design	Energy	Price (£) exc. VAT	Price (£) inc. VAT
<p>Advanced park assist</p> <p>Advanced park assist not only detects suitable parking spaces but also expertly steers into them for you. All you have to do is to drive forward or reverse and brake. The system works with both parallel and bay parking.</p> <ul style="list-style-type: none"> • Automatic pull-out function • Ultrasonic side sensors identify suitable parking spaces at speeds up to 12mph • Fully automated steering • Detailed forward/reverse instructions are shown in the instrument cluster <p>– Only available when the optional Parking Pack is specified.</p>	UFQ		O	166.67	200.00
<p>Head-up display</p> <p>The head-up display projects key information onto the windscreen so that the driver's eyes remain on the road at all times. The display is adjustable for height and brightness. Displays:</p> <ul style="list-style-type: none"> • Navigation directions (where fitted) • Speedometer • Rev counter • Set speed of cruise control and speed limiter • Forward collision alert 	UV6		O	295.83	355.00
<p>All Weather Pack</p> <p>For those drivers who regularly take their vehicle off road, this pack helps the driver cope with whatever conditions they encounter. Please note: The All Weather Pack option affects CO₂ emissions which may result in a change in Vehicle Excise Duty.</p> <ul style="list-style-type: none"> • IntelliGrip: A choice of five selectable modes to suit the driving conditions: ESP on, ESP off, snow, mud or sand • Includes all-weather tyres 	PS4	O	O	341.67	410.00
<p>Sight and Light Pack</p> <ul style="list-style-type: none"> • High beam assist • Rain-sensitive windscreen wipers <p>– Standard on automatic models</p>	CWX	O	●	166.67	200.00
<p>Automatic lighting control</p>		●	●		



FEATURES/OPTIONS

SECURITY

	Option Code	Design	Energy	Price (£) exc. VAT	Price (£) inc. VAT
Standard security features <ul style="list-style-type: none"> • Electronically protected audio equipment • Engine deadlock immobiliser • Visible Vehicle Identification Number (VIN) • Locking wheel nuts (Energy models only) 		●	●		
Remote control central locking <ul style="list-style-type: none"> • Operates on doors, tailgate and fuel filler flap • Deadlocking • Driver's internal central locking activation switch • Two folding keys, each with integral remote control function 		●	●		
Remote control security alarm system <ul style="list-style-type: none"> • Remote control (operates in conjunction with central locking) • Bonnet protection – Prevents access to the engine bay. • Visible security LED on fascia • Luggage protection – Monitors the luggage compartment preventing access. • Door protection – Monitors the position of all doors • Ultrasonic intrusion sensor • Power alarm sounder • Vehicle theft attempt and diagnostic indication – Shows in the display any attempt to enter or steal the vehicle during driver absence. 	PS6	○	○	166.67	200.00



FEATURES/OPTIONS

DRIVER INFORMATION

	Option Code	Design	Energy	Price (£) exc. VAT	Price (£) inc. VAT
Instrumentation <ul style="list-style-type: none"> • Speedometer • Rev counter • Fuel gauge with low fuel level warning light • Water temperature gauge with warning light • Shift-up indication light (manual models only) – Indicates when to change gear for optimum fuel economy. 		●	●		
Driver information display (centrally located in instrument cluster) <ul style="list-style-type: none"> • Displays trip computer data • Total mileage • Service-due indicator • Deflation detection system • 3.5-inch colour information display 		●	●		
Multi-function trip computer (displayed on driver information display) <ul style="list-style-type: none"> • Trip mileage • Vehicle range based on remaining fuel • Average speed • Average fuel economy • Instantaneous fuel economy 		●	●		
Central facia display (format dependent on infotainment unit) <ul style="list-style-type: none"> • Audio information • Digital clock with automatic RDS time adjustment • Outside air temperature with ice warning function • Additional features dependent on infotainment unit (see infotainment for details) 		●	●		



FEATURES/OPTIONS

SEATING AND COMFORT

	Option Code	Design	Energy	Price (£) exc. VAT	Price (£) inc. VAT
Adjustable steering column Reach and rake-adjustable steering column		●	●		
Comfort front seats Driver's seat <ul style="list-style-type: none"> • Height • Reach • Backrest • Manual lumbar adjustment • Armrest • Under seat storage • Four-way adjustable head restraint Front passenger's seat <ul style="list-style-type: none"> • Reach • Backrest • Four-way adjustable head restraint 		●	●		
Rear seating Second-row (5-seat models) <ul style="list-style-type: none"> • Three-person layout 60/40 split-folding rear seat • Height-adjustable and removable head restraints • ISOFIX child seat mountings incorporating top tether anchor points located on rear seats (does not include child seat) – Allows ISOFIX child safety seats to be securely fixed into the car. The ISOFIX mounting system reduces forward movement in an accident and makes the child seat easier to install 		●	●		
Rear seating Second-row (7-seat models) <ul style="list-style-type: none"> • Three-person layout 35/30/35 individual split-folding second-row seats with sliding function (XL models only) plus fold-flat facility • Height-adjustable and removable head restraints • ISOFIX child seat mountings incorporating top tether anchor points located on rear seats (does not include child seat) 			●		
Rear seating Third-row (7-seat models) <ul style="list-style-type: none"> • Two individual removable/folding seats • Height-adjustable and removable head restraints 			●		
Seat trim <ul style="list-style-type: none"> • Mistral Grey with Curitiba fabric seat trim inserts 		●			
Seat trim <ul style="list-style-type: none"> • Mistral Grey with Angora Stripe fabric seat trim inserts 			●		



FEATURES/OPTIONS

HEATING AND VENTILATION

	Option Code	Design	Energy	Price (£) exc. VAT	Price (£) inc. VAT
Air conditioning <ul style="list-style-type: none"> • Air recirculation facility • Cabin particulate filter – Removes dust, airborne particles and pollen. • Multi-speed fan • Illuminated controls 		●	●		
Electronic climate control including air conditioning <ul style="list-style-type: none"> • Dual-zone control – Allowing different, temperature settings for driver and front passenger. • Advanced predictive logic control system using sun sensors • Partial air recirculation – Faster warm up/cool down. • Cabin particulate filter – Removes dust, airborne particles and pollen. • Automatic air direction and fan speed with manual override • LCD temperature display • Illuminated controls 	CJ2	○	○	166.67	200.00
Winter Pack <ul style="list-style-type: none"> • Heated leather-covered steering wheel • Heated front seats – Only available when cruise control and Safety Pack are specified. Not available on automatic models. 	XIBV	○	○	166.67	200.00



FEATURES/OPTIONS

INTERIOR CONVENIENCE AND STORAGE

	Option Code	Design	Energy	Price (£) exc. VAT	Price (£) inc. VAT
Mirrors <ul style="list-style-type: none"> • Dipping rear-view mirror • Driver's and front passenger's sunvisors incorporating illuminated vanity mirrors with covers 		●	●		
Front compartments <ul style="list-style-type: none"> • Two facia-mounted drinks holders • Two drinks holders in centre console • Large open storage pocket behind infotainment screen • Small open storage compartment behind gear knob • Two large and two small open door pockets • Open storage compartment below glovebox • Underseat drawer (driver's side) • Full-width overhead storage shelf with ambient lighting 		●	●		
Sunroof / storage <ul style="list-style-type: none"> • Full-length panoramic glass sunroof with overhead storage and ambient lighting • Storage compartments above rear seats with additional access from rear load area – Not available on XL models or 7-seat models. 	C2K		○	700.00	840.00
Rear compartments <ul style="list-style-type: none"> • Two door pockets 		●	●		
Child Pack <ul style="list-style-type: none"> • Rear-view child-minder mirror – Located above the regular rear-view mirror and lets the driver as well as the front seat passenger keep an eye on the kids and the tailgate whilst maintaining full concentration on the road ahead. • Rear side window sunblind • Fold-flat passenger seat • Luggage restraint net – Only available on 7-seat models. 	WV6		○	208.33	250.00



FEATURES/OPTIONS

MECHANICAL

	Option Code	Design	Energy	Price (£) exc. VAT	Price (£) inc. VAT
Front-wheel drive		●	●		
Five-speed manual gearbox – 1.5 (100PS) diesel models.		▲	▲		
Six-speed manual gearbox – 1.2i Petrol / 1.5 (130PS) diesel models.		▲	▲		
Eight-speed automatic transmission – available on 1.5 (130PS) models.		▲	▲		

FEATURES/OPTIONS

INFOTAINMENT

	Option Code	Design	Energy	Price (£) exc. VAT	Price (£) inc. VAT
<p>Radio</p> <p>Onboard features:</p> <ul style="list-style-type: none"> • AM/FM stereo radio • DAB Digital radio • RDS with Traffic Programme • 20 watts per channel output <p>Media connections:</p> <ul style="list-style-type: none"> • USB connection with iPod control • Bluetooth® A2DP audio streaming (Advanced Audio Distribution Profile) <p>Mobile phone portal:</p> <ul style="list-style-type: none"> • Bluetooth® connectivity • Handsfree calls via steering wheel controls • Vehicle microphone 		●			
<p>Multimedia</p> <p>Onboard features:</p> <ul style="list-style-type: none"> • 8-inch colour touchscreen • AM/FM stereo radio with 25 Station presets • DAB Digital radio • RDS with Traffic Programme • 20 watts per channel output • Four speakers <p>Media connections:</p> <ul style="list-style-type: none"> • USB connection with iPod control • Bluetooth® A2DP audio streaming (Advanced Audio Distribution Profile) <p>Mobile phone portal:</p> <ul style="list-style-type: none"> • Bluetooth® connectivity • Handsfree calls via steering wheel controls • Vehicle microphone • Phone book access – Contacts/last calls/missed calls etc. are mirrored on the display and are easily navigated using the touchscreen (features dependent on mobile phone). <p>Smartphone interface:</p> <ul style="list-style-type: none"> • Apple CarPlay™ • Android Auto™ – Smartphone projection that allows operations via voice command, touchscreen and buttons to control apps and music playback. 	IO5	○	●	166.67	200.00
<p>Multimedia Navi Pro</p> <p>Onboard features:</p> <ul style="list-style-type: none"> • 8-inch colour touchscreen • AM/FM stereo radio with 25 Station presets • DAB Digital radio • RDS with Traffic Programme • 20 watts per channel output • Four speakers <p>Navigation features:</p> <ul style="list-style-type: none"> • Satellite navigation system • 3D street level mapping • European coverage • Structured or one-box destination entry • Points-of-interest search • Eco routing • Map updates via USB <p>Media connections:</p> <ul style="list-style-type: none"> • USB connection with iPod control • Bluetooth® A2DP audio streaming (Advanced Audio Distribution Profile) <p>Mobile phone portal:</p> <ul style="list-style-type: none"> • Bluetooth® connectivity • Handsfree calls via steering wheel controls • Vehicle microphone • Phone book access – Contacts/last calls/missed calls etc. are mirrored on the display and are easily navigated using the touchscreen (features dependent on mobile phone). <p>Smartphone interface:</p> <ul style="list-style-type: none"> • Apple CarPlay™ • Android Auto™ – Smartphone projection that allows operations via voice command, touchscreen and buttons to control apps and music playback. 	IO6	○		541.67	650.00
			○		375.00

● = Standard equipment. ○ = Optional at extra cost.



FEATURES/OPTIONS

INFOTAINMENT CONTINUED

	Option Code	Design	Energy	Price (£) exc. VAT	Price (£) inc. VAT
Steering wheel mounted audio controls		●	●		
Power supply • 12-volt electrical accessory socket in centre console • 12-volt electrical accessory socket (passenger side) • USB charging point in glovebox • USB charging / infotainment points – Infotainment unit and rear of centre console.		●	●		
230-volt electrical accessory socket • 230-volt electrical accessory socket – In lieu of passenger side 12-volt electrical accessory socket.	KI5	○	○	41.67	50.00
Wireless charging • Wireless charger for mobile devices – Inductive wireless charging facility in lower fascia.	K4C	○	○	87.50	105.00





FEATURES/OPTIONS

EXTERIOR STYLING AND CONVENIENCE

	Option Code	Design	Energy	Price (£) exc. VAT	Price (£) inc. VAT
Body styling <ul style="list-style-type: none"> • Chrome-effect front grille bar • Body-colour door handles/mirrors • Body-colour bumpers and side-protection mouldings 			●		
<ul style="list-style-type: none"> • Chrome-effect front grille bar • Body-colour bumpers 		●			
Windscreen / windows <ul style="list-style-type: none"> • Solar heat-absorbing windscreen • Two-speed windscreen wipers with variable intermittent wipe • Electrically operated front windows with safety autoreverse and one-touch facility • Tinted windows • Heated rear window • Intermittent rear window wash / wipe 		●	●		
<ul style="list-style-type: none"> • Dark-tinted rear windows – Only available when Parking Pack or Tailgate with opening window options are specified. 	AKO		○	91.67	110.00
Door mirrors <ul style="list-style-type: none"> • Twin electrically adjustable / heated door mirrors • Manually folding door mirrors • Electrically foldable door mirrors 		● □	● □		
Tailgate <ul style="list-style-type: none"> • Glazed tailgate with heated window and wash / wipe facility • Glazed tailgate with opening heated window and wash / wipe facility – Only available with electrically operated and dark-tinted rear windows. 	J20	●	● ○	254.17	305.00
Tow bar <ul style="list-style-type: none"> • Detachable tow bar • Trailer stability programme integrated into ESP system 	VQ9	○	○	416.67	500.00
Roof rails	E2R	○	○	125.00	150.00



EXTERIOR COLOURS



			Option Code	Design	Energy	Price (£) exc. VAT	Price (£) inc. VAT
Solid		Onyx Black	G7R	●	●		
		White Jade	G20	●	●		
Brilliant		Ruby Red	GEO	○	○	237.50	285.00

The colours reproduced may vary slightly from the actual paint colour. As a result they should be used as a guide only. Your Vauxhall Retailer has a comprehensive display of our paint samples.

● = Standard equipment. ○ = Optional at extra cost.



EXTERIOR COLOURS

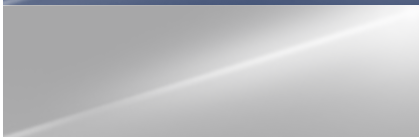
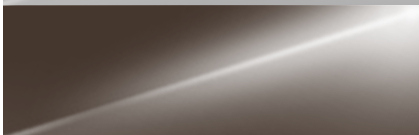

			Option Code	Design	Energy	Price (£) exc. VAT	Price (£) inc. VAT
Two-coat		Cool Grey metallic	GAC				
		Moonstone Grey metallic	G4O				
		Night Blue metallic	GBT	O	O	470.83	565.00
		Quartz Grey metallic	G4I				
		Cosmic Brown pearlescent	GLV				

The colours reproduced may vary slightly from the actual paint colour. As a result they should be used as a guide only. Your Vauxhall Retailer has a comprehensive display of our paint samples.

O = Optional at extra cost.



WHEELS AND TYRES

	Option Code	Design	Energy	Price (£) exc. VAT	Price (£) inc. VAT
 <p>16-inch steel wheels with full diameter wheel covers</p> <ul style="list-style-type: none"> • 205/60 R 16 tyres • Emergency tyre inflation kit (in lieu of spare wheel) 		●			
 <p>16-inch seven-spoke alloy wheels</p> <ul style="list-style-type: none"> • 205/60 R 16 tyres • Emergency tyre inflation kit (in lieu of spare wheel) 			●		
Full-size steel spare wheel (in lieu of emergency tyre inflation kit)	RU9	○	○	91.67	110.00



PERFORMANCE, FUEL ECONOMY AND EMISSIONS

	Performance (manufacturer's figures)				Fuel economy mpg (litres/100km) [#]			CO ₂ emissions g/km [#]	Vehicle Excise Duty*		Benefit in kind company car taxation rates – 2018/19 tax year
	Fuel Type	Wheel size (inches)	Maximum speed (mph)	Acceleration 0–60mph (sec)	Urban driving	Extra-urban driving	Combined figure		First year rate	Standard rate	
COMBO LIFE											
1.2 (110PS) Turbo S/S	Petrol	16	109	11.9	44.8 (6.3)	56.5 (5.0)	51.4 (5.5)	125	£165	£140	26%
1.5 (100PS) Turbo D S/S BlueInjection	Diesel	16	107	12.7	62.8 (4.5)	70.6 (4.0)	67.3 (4.2)	111	£205	£140	27%
1.5 (130PS) Turbo D S/S BlueInjection	Diesel	16	115	10.6	58.9 (4.8)	70.6 (4.0)	65.7 (4.3)	113–114	£205	£140	27%
1.5 (130PS) Turbo D S/S BlueInjection automatic	Diesel	16	114	11.4	61.4 (4.6)	68.9 (4.1)	65.7 (4.3)	113	£205	£140	27%
COMBO LIFE XL											
1.2 (110PS) Turbo S/S	Petrol	16	109	12.0	44.8 (6.3)	56.5 (5.0)	51.4 (5.5)	125	£165	£140	26%
1.5 (100PS) Turbo D S/S BlueInjection	Diesel	16	107	12.9	60.1 (4.7)	68.9 (4.1)	65.7 (4.3)	114	£205	£140	27%
COMBO LIFE (7-seat)[†]											
1.2 (110PS) Turbo S/S	Petrol	16	109	11.8	44.8 (6.3)	56.5 (5.0)	51.4 (5.5)	125	£165	£140	26%
1.5 (100PS) Turbo D S/S BlueInjection	Diesel	16	106	12.7	60.1 (4.7)	68.9 (4.1)	65.7 (4.3)	115	£205	£140	28%
COMBO LIFE XL (7-seat)[†]											
1.5 (100PS) Turbo D S/S BlueInjection	Diesel	16	106	13.0	60.1 (4.7)	67.3 (4.2)	65.7 (4.3)	115	£205	£140	28%

S/S = Start/Stop.

*Correct at time of publication.

[†]Available on Energy models only.

[#]Fuel consumption data and CO₂ emission data are determined using the Worldwide harmonized Light vehicles Test Procedure (WLTP), and the relevant values are translated back to allow the comparability into NEDC, according to regulations R (EC) No. 715/2007, R (EU) No. 2017/1153 and R (EU) No. 2017/1151. The values do not take into account in particular use and driving conditions, equipment or options and may vary depending on the format of tyres. For more information on official fuel consumption and CO₂ emission values, please read the guidelines at <http://carfueldata.dft.gov.uk/> and for more information on WLTP please see www.vauxhall.co.uk/wltp

DIMENSIONS

COMBO	LIFE	LIFE XL
Loadspace Dimensions millimetres (inches)		
Maximum load floor length – passenger seat folded	2700 (106.3)	3050 (120.1)
Maximum load length – behind front seats	1880 (74.0)	2230 (87.8)
Maximum load length – behind second-row seats	914 (36.0)	1350 (53.1)
Maximum load length – behind third-row seats†	236 (9.3)	418 (16.5) – 566 (22.3)
Maximum load height	1126 (44.3)	1119 (44.0)
Maximum load width	1195 (47.0)	1195 (47.0)
Maximum width between wheel arches	1149 (45.2)	1129 (44.4)
Loading height	584 (23.0)	620 (24.4)
Maximum tailgate aperture width	1087 (42.8) – 1241 (48.9)	1087 (42.8) – 1241 (48.9)
Maximum tailgate aperture height	1126 (44.3)	1126 (44.3)
Maximum height under raised tailgate	1892 (74.5)	1892 (74.5)
Maximum side-access aperture width	640 (25.2) – 745 (29.3)	640 (25.2) – 745 (29.3)
Maximum side-access aperture height	1145 (45.1)	1145 (45.1)
Loadspace Capacities* litres (cu.ft.)		
Behind front-row seats to glassline	1414 (49.9)	1672 (59.0)
Behind front-row seats to roof	2126 (75.1)	2693 (95.1)
Behind second-row seats to glassline	597 (21.1)	850 (30.0)
Behind second-row seats to roof	983 (34.7)	1538 (54.3)
Behind third-row seats†	571 (20.2)	806 (28.5)

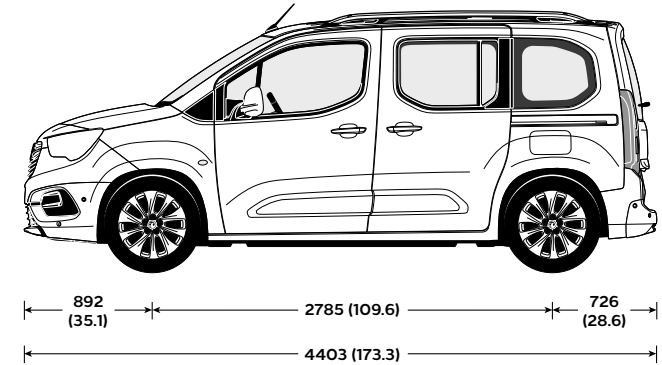
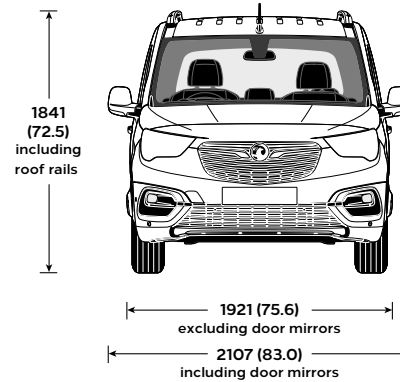

LIFE

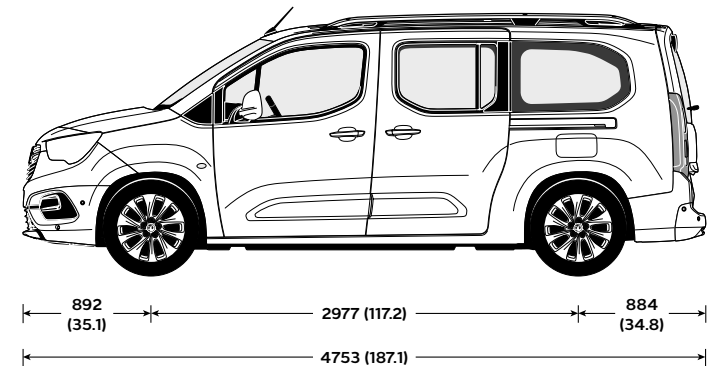
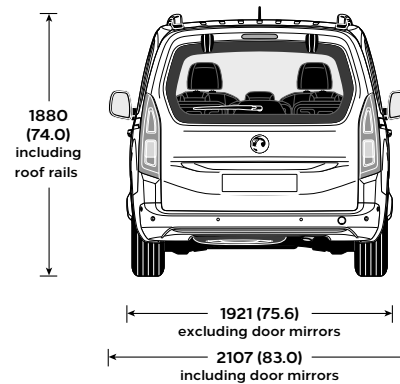

LIFE XL

All measurements are in mm (inches) unless stated otherwise.

†Energy models only.

*Measured using the VDA method.



SPECIFICATIONS

Transmission

Five-speed manual gearbox:
1.5 (100PS) Turbo D models.

Six-speed manual gearbox:
1.2 (110PS) Turbo / 1.5 (130PS) Turbo D models.

Eight-speed automatic transmission:
1.5 (130PS) Turbo D models.

Replacing the traditional lever, the automatic transmission selection-mode dial/drive wheel is an innovation solution that is both elegant and intuitive. By simply twisting the dial, the following modes can be selected:

- Park, for when the vehicle is stationary and the wheels are locked
- Drive, for automatic forward motion
- Neutral, for when the vehicle is stationary, wheels are free
- Reverse, for automatic backward motion

Fuel tank capacity

61 Litres (13.4 gallons) – Petrol models.
50 Litres (10.9 gallons) – Diesel models.

AdBlue tank capacity

17 Litres (3.7 gallons).

Steering

Turning circle (kerb-to-kerb) –
11.0m (36 ft) Life models,
11.8m (38.7 ft) Life XL models.

Weights and Towing Data

	Gross Vehicle Weight (GVW)	Maximum towing weights, braked (unbraked)
COMBO LIFE		
1.2 (110PS) Turbo	2040	1150 (600)
1.5 (100PS) Turbo D	2095	1300 (730)
1.5 (130PS) Turbo D	2120	1500 (730)
1.5 (130PS) Turbo D automatic	2130	1500 (730)
1.2 (110PS) Turbo (7-seat)	2205	1100 (600)
1.5 (100PS) Turbo D (7-seat)	2250	1150 (600)
COMBO LIFE XL		
1.2 (110PS) Turbo	2070	1100 (600)
1.5 (100PS) Turbo D	2115	1250 (600)
1.5 (100PS) Turbo D (7-seat)	2310	1250 (600)



PETROL ENGINE

Engine	1.2 (110PS) Turbo Start/Stop
Capacity	1199cc
Maximum power	110PS (81kW) @ 5500rpm
Maximum torque	205Nm (151 lb.ft.) @ 1750rpm
Configuration	3 cylinders, 4 valves per cylinder, double overhead camshafts
Fuel/induction system	Turbocharger. Variable Valve Timing. Direct fuel injection
Emission compliance	Euro 6d-TEMP (6.2)
Service interval	16,000 miles or 1 year (whichever occurs sooner)



DIESEL ENGINES

Engine	1.5 (100PS) Turbo D Start/Stop BlueInjection	1.5 (130PS) Turbo D Start/Stop BlueInjection
Capacity	1499cc	1499cc
Maximum power	100PS (75kW) @ 3500rpm	130PS (96kW) @ 3750rpm
Maximum torque	250Nm (184 lb.ft.) @ 1750rpm	300Nm (221 lb.ft.) @ 1750rpm
Configuration	4 cylinders, 4 valves per cylinder, double overhead camshafts	4 cylinders, 4 valves per cylinder, double overhead camshafts
Fuel/induction system	Variable-nozzle turbocharger with electric switching. Common rail direct injection	Variable-nozzle turbocharger with electric switching. Common rail direct injection
Emission compliance	Euro 6d-TEMP (6.2). Diesel Particulate Filter	Euro 6d-TEMP (6.2). Diesel Particulate Filter
Service interval	20,000 miles or 1 year (whichever occurs sooner)	20,000 miles or 1 year (whichever occurs sooner)



COMPANY CAR DRIVER AND FLEET INFORMATION

Design and Tech Line High Spec Low P11D

Specifically developed for businesses and company car drivers alike, our Design and Tech Line Nav models are seriously fit for Fleet.

Design models all feature very low P11D values, generous standard specification, including Sat Nav on Design Nav models, and a choice of high tech ecoTEC engines for great fuel economy and low emissions.

For even more standard specification, step up to our Tech Line Nav range. Again you are guaranteed low P11D values, plus great standard kit including Sat Nav, Bluetooth®, USB connection, aux-in socket and digital radio.

With Design and Tech Line Nav you can take for granted low Whole Life Costs and low company car driver taxation.

Company Car Driver Free 3 Day Test Drive

Our free* 3 Day Test Drive programme is open to all Company Car Drivers which allows you to choose any model in the current Vauxhall line-up (exclusions apply). With full insurance cover provided, it gives you a meaningful length of time to make an informed decision about your next company car.

Search Vauxhall 3DTD to book your FREE* test drive or click the link the below:

[Vauxhall 3 Day Test Drive](#)

*The free 3 Day Test Drive programme is open to Company Car Drivers and Fleet Decision Makers. Available for UK Mainland only. Terms and conditions apply. Full terms and conditions can be found at vauxhallfleet.co.uk/testdrive/index/terms.

Benefit in kind company car taxation†

The car benefit charge will be the car's list price (including VAT, options and accessories fitted, delivery to Retailer and number plates, but excluding Vehicle Excise Duty and new vehicle first registration fee) multiplied by the percentage charge for the CO₂ emissions band in which the car falls (see table opposite). Multiply this figure by your personal income tax rate (20%^{††} for Basic Rate, 40%^{††} for Higher Rate) to calculate your annual benefit in kind tax liability.

Example:

Combo Life Design 1.5 (100PS) Turbo D S/S BlueInjection (CO₂ emissions 111g/km)

On-the-road RRP	£20,140.00
Deduct: Vehicle Excise Duty	(£205.00)
New vehicle first registration fee	(£55.00)
Effective list price	£19,880.00
Add: Optional two-coat metallic paint	£565.00
List price for tax purposes (P11D value)	£20,445.00
Car benefit charge 2018-19 tax year (27%)	£5,520.00
Benefit in kind tax liability (2018-19 tax year)	
Basic Rate (20%) tax payer	£1,104.00
Higher Rate (40%) tax payer	£2,208.00

†Please note this Price Guide provides taxation information as a guide only. Vauxhall does not provide taxation guidance. Drivers should always take professional advice on their own tax position. ††Excludes residents of Scotland.

BIK FOR SCOTTISH RESIDENTS

Effective 6 April 2018 the Scottish Government have introduced their own BIK taxation structure. This only applies to Company Car Drivers that are Scottish taxpayers. HMRC will determine whether or not an individual is a Scottish taxpayer based on where their main place of residence is.

The BIK rates for Scotland are:

- Over £11,850-£13,850 Starter Rate 19%
- Over £13,850-£24,000 Basic Rate 20%
- Over £24,000-£43,430 Intermediate Rate 21%
- Over £43,430-£150,000 Higher Rate 41%
- Above £150,000 Top Rate 46%

Benefit in kind company car taxation table

CO ₂ emissions in grams per kilometre	Percentage of cars price to be taxed	
	Non-Diesel [†] 2018-19 tax year	Diesel ^{††} 2018-19 tax year
Up to 50	13	17
51-75	16	20
76-94	19	23
95-99	20	24
100-104	21	25
105-109	22	26
110-114	23	27
115-119	24	28
120-124	25	29
125-129	26	30
130-134	27	31
135-139	28	32
140-144	29	33
145-149	30	34
150-154	31	35
155-159	32	36
160-164	33	37
165-169	34	37
170-174	35	37
175-179	36	37
180 and above	37	37

†Also applies to diesel vehicles that meet the Real Driving Emissions Step 2 (RDE2). ††Applies to vehicles that do not meet the Real Driving Emissions Step 2 (RDE2).

To calculate your own personal liability, search: **Vauxhall BiK**, or click the link below: [Vauxhall BiK Tool](#)

Fleet Toolbox

Discover the facts in our online Toolbox for both Company Car Drivers and Fleet Decision Makers. The Fleet Toolbox has a host of useful calculators, comparators, interactive listings and information.

Search Vauxhall Fleet Tools or click the link below:

[Vauxhall Fleet Tool Box](#)

Contact Vauxhall Fleet

Please contact one of our dedicated sales teams who will be happy to help with your particular enquiry.

Company Car Drivers

Call: 0345 111 2020

Email: company-car@vauxhallinfo.co.uk

Telephone lines are open

– Monday to Friday 8:00am–9:00pm

– Saturday and Sunday 9:00am–6:00pm

Fleet Decision Makers

Depending on the size of your fleet of vehicles, we have a dedicated team to handle your enquiries. The lines are open Monday to Friday excluding Bank Holidays.

1-24 vehicles

Call: 0845 076 2254 (8:30am–5:00pm)

25+ vehicles

Call: 0330 587 8222 (8:30am–5:00pm)

Email: vauxhallfleet@vauxhall.co.uk

Special Vehicles (Police, Fire and Ambulance)

Call: 01582 409999 (8:30am–5:00pm)

Email: vauxhallspecialvehicles@vauxhall.co.uk



FURTHER INFORMATION

On-the-road prices

To eliminate uncertainty about hidden costs when buying a new car, Vauxhall publishes on-the-road recommended retail prices (RRP) and these are shown in the pricing tables within this price guide. These prices include VAT, number plates and delivery to Retailer of £700.00 (including £116.67 VAT), 12 months' Government Vehicle Excise Duty (see opposite for details) and the DVLA new vehicle first registration fee of £55.00.*

Please note: The on-the-road recommended retail price (RRP) does not include fuel supplied by the Retailer, motor insurance or any other goods or services supplied by agreement between the Retailer and the customer.

Price protection

Order a new Vauxhall for build in the current model year (as confirmed by your Retailer) for delivery no more than three months in advance and the price you are quoted is the price you pay. This is irrespective of any subsequent price rises between placing your order and delivery of your new car, but you must take delivery as soon as the car is available. Vauxhall Motors Limited is not liable for price adjustments caused by Government changes in the rate of VAT (currently 20%), Vehicle Excise Duty, DVLA new vehicle first registration fee or by any other applicable legislation or regulations.

Vauxhall Finance Leasing

Vauxhall Finance Leasing is a trading style of Vauxhall Finance plc. Working with the Vauxhall Retailer network we provide competitive car and van leasing solutions for business users and private individuals. We combine the support of a national contract with the convenience of a local contact. For further information, please contact your local Vauxhall Retailer or visit www.vauxhall.co.uk/leasing

In the event of an accident

Vauxhall Accident Management helps keep you mobile following an accident. Benefits include vehicle recovery, Vauxhall-approved repairs and contacting your insurer. For more details, visit www.vauxhall.co.uk/AccidentManagement

Vehicle Excise Duty

The amount of Vehicle Excise Duty (road fund licence) payable on new cars varies depending on the level of carbon dioxide (CO₂) emissions produced by the vehicle. CO₂ emissions are measured in grams per kilometre (g/km) travelled and divided into 13 charging bands shown in the table opposite.

A 'first year rate' of Vehicle Excise Duty is payable on all new cars and in subsequent years the amount payable reverts to the 'standard rate'. From 1 April 2017 the breakpoints for each of these bands have been revised. Also, for vehicles with a list price over £40,000, including factory-fitted options, an additional £310 is payable for the first five years of standard rate payments.

Vehicle Excise Duty*

Band	CO ₂ emissions in grams per kilometre	First year rate		
		Petrol [#]	Diesel [†]	Standard rate
A	0	£0	£0	£0
B	1-50	£10	£25	£140
C	51-75	£25	£105	£140
D	76-90	£105	£125	£140
E	91-100	£125	£145	£140
F	101-110	£145	£165	£140
G	111-130	£165	£205	£140
H	131-150	£205	£515	£140
I	151-170	£515	£830	£140
J	171-190	£830	£1,240	£140
K	191-225	£1,240	£1,760	£140
L	226-255	£1,760	£2,070	£140
M	over 255	£2,070	£2,070	£140

Insurance Groups

	Design	Energy
1.2 (110PS) Turbo	8E	8E
1.5 (100PS) Turbo D	8E - 9E	8E - 9E
1.5 (130PS) Turbo D	-	12E
1.5 (130PS) Turbo D automatic	12E	12E
1.2 (110PS) Turbo (7-seat)	-	8E
1.5 (100PS) Turbo D (7-seat)	-	8E - 9E

*Correct at time of issue.

[#]Also applies to diesel vehicles that meet the Real Driving Emissions Step 2 (RDE2).

[†]Applies to vehicles that do not meet the Real Driving Emissions Step 2 (RDE2).



FURTHER INFORMATION

Customer Care Commitment

For added peace of mind, Vauxhall has an innovative Customer Care Commitment that offers the following:

- Three-year vehicle warranty consisting of a one-year/unlimited mileage manufacturer's warranty and a second and third year manufacturer's warranty with a 60,000 miles limitation
- Vauxhall Assistance for 12 months from first registration
- Six years' body panel anti-perforation warranty

Please note: Warranty is only available on vehicles sourced from Vauxhall Motors Limited. Terms and conditions apply. Please see your Vauxhall Retailer for details.

Vauxhall Assistance

Vauxhall Assistance is provided automatically with every new Vauxhall for 12 months from first registration and covers everything from accident assistance, roadside recovery and 'at home' service to flat tyres. With Vauxhall Assistance help is literally just a free* phone call away, 24 hours a day, 365 days a year!

*Mobile phone users will be charged at their standard tariff.

Protecting the environment

Vauxhall's commitment to the environment is demonstrated by our products' many environmental awards. For even more information on Vauxhall's efforts to achieve an environmentally sustainable future, and how to dispose of your end-of-life vehicle, see www.vauxhall.co.uk/recycling

Vauxhall Service Plan

- Fixed monthly payments for the plan duration
- Easy to budget and interest-free
- Genuine parts fitted by Vauxhall-trained technicians
Plus on Gold plans:
- Valet and courtesy car
- Full AA cover
- Engine flush and fuel treatments
- Litre of oil for top ups between services

Full details can be obtained from your local participating Vauxhall Retailer.

Vauxhall Insurance with added reassurance

Comprehensive cover – Summary of benefits**

- Competitive premiums
- Repairs by a Vauxhall-trained technician
- Genuine Vauxhall parts, guaranteed for three years when we repair your car within our Approved Repairer Network
- Free courtesy car as standard when using an Approved Repairer†
- 24 hour claims helpline
- Personal Accident benefit
- Cover for audio equipment
- Windscreen cover

Call for a quote on **0844 463 2670**††

**The benefits listed above are for comprehensive cover only. For details of Third Party, Fire and Theft cover, please call our sales team.

†Should your car need repairing following an accident we provide a courtesy car (subject to availability) for the duration of the repair. Only genuine Vauxhall parts are used. Terms and conditions apply.

††Calls may be recorded. Vauxhall Insurance is underwritten by Ageas Insurance Limited.

For more product information

For a brochure on any Vauxhall model (up to a maximum of three per caller) or location of your nearest Vauxhall Retailer please call **0345 600 1500**. Alternatively, details can be found on our website at www.vauxhall.co.uk

Join us online



VAUXHALL

vauxhall.co.uk

©2018 Vauxhall Motors Limited

Published 7 June 2018 (Amended 7 December 2018) Vauxhall Motors Limited