

Price and Specification Guide  
13 March 2024 | Model Year 2024A



# New Combo Life

All Electric Range

# Contents

To find the information you want use the links below to navigate around the guide:

---

[Choose Your Trim Level](#)

---

[Range Highlights](#)

---

[Models](#)

---

[Prices](#)

---

[Features/Options](#)

---

[Infotainment](#)

---

[Interior Style and Comfort](#)

---

[Exterior Colours](#)

---

[Wheels and Tyres](#)

---

---

[Specifications](#)

---

[Dimensions and Capacities](#)

---

[Accessories](#)

---

[Company Car Information](#)

---

[Further Information](#)

---



Effective 13 March 2024

New Combo Life Model Year 2024A

# Choose Your Trim Level



## Design

VAUX-HALL-COMBO-LIFE-MY2023-BEV-EXTERIOR-WHITE-INT-05-Sg.jpg

First up in the range is the Combo Life Electric Design, which is packed with plenty of practical features as standard. Choose from 5- or 7-seats.

## Ultimate

VAUX-HALL-COMBO-LIFE-MY2023-BEV-EXTERIOR-WHITE-INT-05-Sg.jpg

Combo Life Electric Ultimate completes the range, with a little more exterior style and extra comfort features.

# Combo Life Range Highlights

## Design

### Standard features include:

- Multimedia audio system
  - IVI MID: Radio AM/FM/DAB
  - 10" HD Touch screen with Mirror Screen (WiFi)
  - 4G connectivity + voice control + E-call + A-call
  - Two speakers & two tweeters
  - Apple CarPlay/Android Auto
- Vauxhall Connect
- 10-inch colour instrument display
- Six-way driver's seat with lumbar adjustment
- Panels for regenerative braking;
  - Light, Medium, Strong
- Four-way passenger seat with storage on back of seat
- 1/3 – 2/3 rear folding second-row bench seats
- Electronic parking brake
- Nearside and offside sliding side-access door with opening windows
- Tailgate with opening heated rear window and wiper
- Body-colour front and rear bumpers
- Black side-protection mouldings
- Body-colour door handles and side-access door rail covers
- Front fog lights
- 16-inch alloy wheels
- Electrically adjustable/foldable/heated door mirrors
- Rain-sensitive windscreen wipers
- High beam assist

- Electrically operated front and rear windows
- Dark-tinted rear windows
- Daytime running lights
- Rear parking distance sensors
- Advanced emergency braking system
- Electronic stability control and ABS with hill start assist
- Forward collision alert
- Lane keep assist
- Cruise control with speed limiter
- Intelligent speed assistance speed limit information

## Design XL 7-seat

### XL 7-seat models additionally feature:

- Two individual split-folding and removable third-row seats
- Sliding facility for third-row seats

## Ultimate

### Features over Design models:

- Multimedia Navi Pro system
  - Satellite navigation
- Chrome-effect instrument rings
- Body-colour side-protection mouldings
- Panoramic rear-view camera
- LED daytime running lights
- Dual-zone electronic climate control
- Alloy-effect protective front skid plate
- Black painted door mirrors
- 33/33/33 split-folding second-row seats with fold-flat facility



# Combo Life Electric Design



<No intersecting link>

## Design OTR from £32,180

### Infotainment:

- Multimedia audio system
  - IVI MID: Radio AM/FM/DAB
  - 10" HD Touch screen with Mirror Screen (WiFi)
  - 4G connectivity + voice control + E-call + A-call
  - Two speakers & two tweeters
  - Apple CarPlay/Android Auto
- Vauxhall Connect

### Interior convenience/styling:

- Full roof finish with overhead storage
- 10" digital cluster
- Six-way driver's seat with lumbar adjustment
- Panels for regenerative braking;
  - Light, Medium, Strong
- Four-way passenger seat with storage on back of seat
- Fabric carpet floor trim (Row 1, 2, 3)
- Air conditioning
- Polyurethane steering wheel
- Steering wheel mounted audio controls
- 1/3 - 2/3 rear folding second-row bench seats
- Chrome-effect interior door handles
- Luggage compartment cover
- Chrome-effect instrument rings
- Electronic parking brake
- 12 volt socket in dashboard
- Central rearview mirror - black painted cover
- 4 tie bracket points on lower trunk area

### Exterior convenience/styling:

- Two sliding doors with tinted opening window, two tinted non-opening windows in row 3
- Body-colour front and rear bumpers

- Black side-protection mouldings
- Offside opening window, 2 opening windows row 3
- Tailgate with opening heated rear window and wiper
- Body-colour door handles and side-access door rail covers
- Front fog lights
- 16" Steel wheels with full size hubcap
- Toolbox
- Roof bar predisposition
- Electrically adjustable heated door mirrors
- Rain-sensitive windscreen wipers
- High beam assist
- Electrically operated front windows
- Daytime running lights
- Matrix LED headlights

### Safety/security:

- Rear parking distance sensors
- Advanced emergency braking system
- Electronic stability control and ABS with hill start assist
- Forward collision alert
- Lane keep assist
- Automatic lighting control
- Cruise control with speed limiter
- Intelligent speed assistance speed limit information
- Six airbags
- Driver attention alert
- Tyre pressure monitoring system

## Design XL 7-seat

OTR from £33,080

- 7-seat models additionally feature:**
- Two individual tiltable and removable third-row seats
  - Sliding facility for third-row seats

# Combo Life Electric Ultimate



<No intersecting link>

## Ultimate OTR from £34,695

### Infotainment:

- Multimedia audio system
  - IVI MID: Radio AM/FM/DAB
  - 10" HD Touch screen with Mirror Screen (WiFi)
  - 4G connectivity + voice control + E-call + A-call
  - Four speakers & two tweeters
  - Apple CarPlay/Android Auto
  - 1 x USB Type C (Data & charge), 1 x USB Type C (Charge Only)
- Vauxhall Connect

### Interior convenience/styling:

- 10" digital cluster
- Six-way driver's seat with lumbar adjustment
- 4 tie bracket points on lower trunk area
- Electronic dual-zone climate control
- Full roof finish with overhead storage
- Steering wheel mounted audio controls
- 33/33/33 split-folding second-row seats with fold-flat facility
- Chrome-effect interior door handles
- 12 volt socket in dashboard and row 2
- Luggage compartment cover
- Chrome-effect instrument rings
- Heated leather steering wheel
- Panels for regenerative braking; Light, Medium, Strong
- Individual codriver seat with armrest. Electric, heated and massage
- Central rearview mirror - black painted cover
- Front-seat back pockets
- Fabric carpet floor trim (row 1, 2, 3)
- Two foldable tables with cupholders
- Electronic parking brake

### Exterior convenience/styling:

- Nearside and offside sliding side-access door with opening windows
- Dark tinted rear tailgate with opening heated rear window and wiper
- Body-colour front and rear bumpers with skidplate
- Painted shiny black side protection mouldings
- Body-colour door handles and side-access door rail covers
- Black painted door mirrors
- Front fog lights
- 16-inch alloy wheels
- Toolbox
- Roof rails
- Electrically adjustable/foldable/heated door mirrors
- Rain-sensitive windscreen wipers
- High beam assist
- Electrically operated front and rear windows
- Dark-tinted rear windows
- Panoramic rear-view camera
- Matrix LED headlights

### Safety/security:

- Rear parking distance sensors
- Advanced emergency braking system
- Electronic stability control and ABS with hill start assist
- Forward collision alert
- Lane keep assist
- Automatic lighting control
- Cruise control with speed limiter
- Intelligent speed assistance speed limit information
- Six airbags
- Driver attention alert
- Tyre pressure monitoring system
- Digital Visiopark 180

# Combo Life Electric Prices

	Electrical Range	LCDV Code	Price (£)	VAT (£)	Total (£)	On-the-road Costs	On-the-road RRP (£)	P11D Value (£)	2023/24 BIK %
<b>Design (5-seat)</b>									
100kW (136PS) auto – 50kWh battery	199	1GK9AF8ZIFT0A070	26,021.00	5,204.20	31,225.20	955	<b>32,180.20</b>	32,125.20	2%
<b>Design XL (7-seat)</b>									
100kW (136PS) auto – 50kWh battery	199	1GK9CL8ZIFT0A070	26,771.00	5,354.20	32,125.20	955	<b>33,080.20</b>	33,025.20	2%
<b>Ultimate (5-seat)</b>									
100kW (136PS) auto – 50kWh battery	199	1GK9AF5ZIFT0A070	28,117.00	5,623.40	33,740.40	955	<b>34,695.40</b>	34,640.40	2%

WLTP Combined CO<sub>2</sub> (g/km) figures are based on a configured vehicle as per LCDV code for UK with no options fitted.

**Please note:** On-the-road recommended retail prices (RRP) include number plates and delivery to Retailer of £900.00 (including £150.00 VAT), 12 months' Vehicle Excise Duty and new vehicle first registration fee of £55.00. Excludes fuel and insurance. Company Car Benefit in Kind (BiK) rates are monthly based on the standard paint price. Price has been calculated using manufacturer estimates. Retailers may be required to carry out more than one credit check during the course of the order process. You may be required to place a deposit when placing your order with your supplying Retailer. In the event of a price change, deposit refunds will be governed by your supplying Retailer's policy and as such must be discussed with the supplying Retailer.

# Combo Life Prices

Only available for conversion to a wheelchair accessible vehicle

	LCDV Code	Fuel Type	Price (£)	VAT (£)	Total (£)	On-the-road RRP (£)	Financial Year 2023/24 BiK 20% (£)	WLTP Combined CO <sub>2</sub> (g/km) <sup>#</sup> - LCDV Code	Insurance Groups
<b>Design (5-seat)</b>									
1.5 (100PS) Turbo D	1GK9AF8P6KT0A070	Diesel				Pricing available upon request to Vauxhall fleet sales team		TBC	TBC
1.5 (130PS) Turbo D auto	1GK9AF8P41T0A070	Diesel				Pricing available upon request to Vauxhall fleet sales team		TBC	TBC
<b>Design XL (7-seat)</b>									
1.5 (100PS) Turbo D	1GK9CL8P6KT0A070	Diesel				Pricing available upon request to Vauxhall fleet sales team		TBC	TBC
1.5 (130PS) Turbo D auto	1GK9CL8P41T0A070	Diesel				Pricing available upon request to Vauxhall fleet sales team		TBC	TBC

Combo Life's diesel engines meet the Real Driving Emissions Step 2 (RDE2) standards.

WLTP Combined CO<sub>2</sub> (g/km) figures are based on a configured vehicle as per LCDV code for UK with no options fitted.

<sup>#</sup>Fuel consumption and CO<sub>2</sub> figures are determined according to the WLTP test cycle. CO<sub>2</sub> figures, BiK values and RRP pricing shown above are for a standard vehicle without any additional optional equipment. CO<sub>2</sub> figures are used to calculate Vehicle Excise Duty (VED) for the first registration of the vehicle and BiK. The addition of optional extras could increase the certified CO<sub>2</sub> emission output. This in turn may affect the amount of VED payable upon registration, and, for company car drivers, the P11D value and the amount of Benefit in Kind (BiK) tax payable. Figures shown are for comparison purposes and should only be compared to the fuel consumption and CO<sub>2</sub> values of other cars tested to the same technical standard. The fuel consumption achieved, and CO<sub>2</sub> produced, in real world conditions will depend upon a number of factors including, but not limited to: the accessories fitted (pre and post registration); variations in weather; driving styles and vehicle load. The WLTP (Worldwide Harmonised Light Vehicles Test Procedure) is used to measure fuel consumption and CO<sub>2</sub> figures. Full data relating to WLTP test cycles can be found at: [www.vauxhall.co.uk/wltp](http://www.vauxhall.co.uk/wltp)



# Safety

**Standard Features** – The following features are standard across the entire Combo Life range.

## Airbags

- Driver's airbag
- Front passenger's airbag
- Two front seat side-impact airbags
- Full-size curtain airbags

## Seating

- Three height adjustable rear seat head restraints

## Seatbelts

- Lap and diagonal inertia-reel seatbelts
- 'Seatbelt unfastened' audible warning and warning light

## Braking

- Automatic emergency braking – The system works automatically in conjunction with forward collision alert, at speeds between 3mph and 70mph, and detects both vehicles and pedestrians. If no avoiding action is taken by the driver, at speeds below 19mph the system automatically slows the vehicle to a full stop with emergency braking of 0.9g. At speeds from 19mph to 70mph it brakes automatically to reduce speed by a maximum of 30mph – to reduce speed even further the driver must brake themselves

- Anti-lock Braking System (ABS)
- Electronic brakeforce distribution – Automatically apportions the optimum braking force to each wheel
- Engine drag torque control – Improves directional stability by preventing the driven wheels from locking on slippery surfaces under the influence of engine braking
- Hill start assist – Briefly maintains rear brake pressure to stop the vehicle rolling back on an incline

## Child safety

- Deactivation switch for front passenger's front and side-impact airbags
- ISOFIX child seat mountings incorporating top tether anchor points located on second-row rear seats (does not include child seat) – Allows ISOFIX child safety seats to be securely fixed into the car. The ISOFIX mounting system reduces forward movement in an accident and makes the child seat easier to install
- Child-proof locks on rear doors

## Stability

- Electronic Stability Programme (ESP) – ESP monitors many different inputs to determine when the car starts to lose traction, it can then immediately respond by varying the brake pressure between up to three wheels and adjust the engine output to help correct the loss of traction and improve stability

## Additional ESP features

- Traction control
- Cornering brake control
- Straight line stability control
- Drag torque control – Maintain stability on slippery roads when lifting off the accelerator or changing gear

## Tyre pressure

- Tyre pressure monitoring system

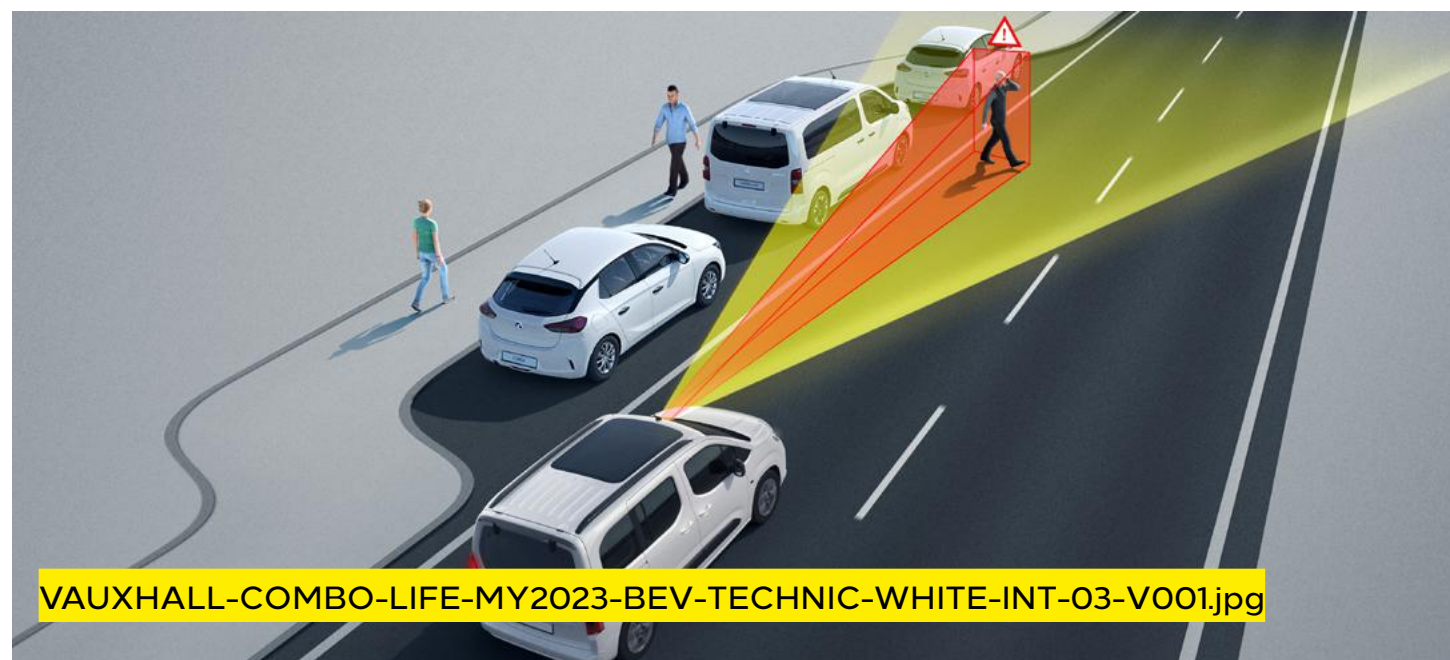

Automatic emergency braking.



ISOFIX child seat mountings.

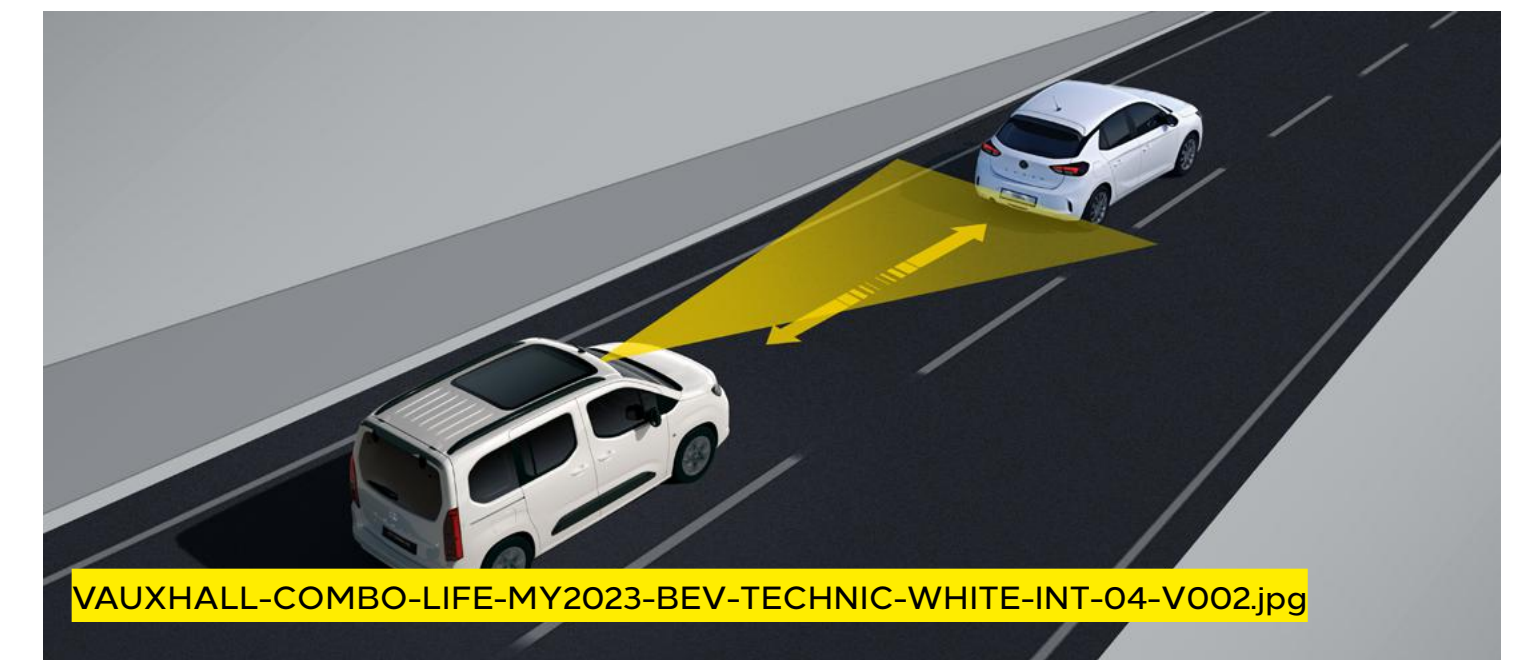

Lane keeping assist (see next page for feature description).

# Driver Assistance

**Standard Features** – The following features are standard across the entire Combo Life range. Specific features by model are outlined in the separate tabular information.

**Cruise control with speed limiter**

With steering wheel mounted controls. Enables you to maintain a constant speed, making it ideal for economical motorway driving.

**Steering**

- Speed sensitive electrically assisted power steering
- Reach and rake adjustable steering column

**Front camera system**

A range of class-leading driver assistance and safety features are controlled by the front camera system

**Forward collision alert**

The system operates automatically from 3mph and gives an audible warning as well as a visual warning when approaching another vehicle too quickly

**Speed sign recognition**

Detects and then displays speed limits, reducing uncertainty and the risk of speeding.

- Recognises different speed signs, including temporary speed restrictions
- Displays reminder in the instrument cluster

**Driver attention alert**

The system monitors driving time and driving behaviour to help prevent accidents caused by tiredness

**Lane keeping assist**

If the driver has not actively steered or signalled, the system performs corrective steering actions to help prevent the vehicle crossing painted boundary lines or road side edges.

**Wipers**

- Intermittent rear window wash/wipe
- Magic Wash System – Mounted in the front windscreen wipers, Combo Life Electric models benefit from our innovative windscreen wash system, designed to more effectively distribute water and reduce wastage. Using nozzles located above the wiper blades, fluid is distributed as the wiper sweeps the windscreen. This avoids the ‘temporary blindness’ of more conventional bonnet mounted systems between fluid release and wiper sweeping, improving visibility

## Model Specific Features/Option

	Option code	Design	Ultimate
<b>Driver Assistance</b>			
Digital Visiopark 180	QK13	£150	●
Rear parking distance sensors		●	●
High beam assist		●	●
Rain-sensitive windscreen wipers		●	●
<b>Drive Assist Pack</b> - Highway Integrated Assist (HIA)                      - Adaptive Cruise Control with Stop & Go (ACC) - Lane Positioning Assist (LPA)                              - Extended Panels Recognition (e-TSR)                      - AEBS3	ZVLO		£1,100

# Driver Information and Security

**Standard Features** – The following features are standard across the entire Combo Life range. Specific features by model are outlined in the separate tabular information.

## Driver Information

### Instrumentation

- Speedometer and rev counter
- Digital fuel gauge with low fuel level warning light
- Digital water temperature gauge with warning light
- Shift-up/down indication light – Indicates when to change gear for optimum fuel economy

### Driver information display

**(centrally located in instrument cluster)**

- Trip computer data
- Total mileage
- Service-due indicator
- Tyre pressure monitoring system

### Multi-function trip computer

**(displayed on driver information display)**

- Trip mileage
- Vehicle range
- Average speed
- Driving time

### Central facia display

**(format dependent on infotainment unit)**

- Audio information
- Digital clock with automatic RDS time adjustment
- Outside air temperature with ice warning function
- Additional features dependent on infotainment unit (see infotainment for details)

## Security

- ‘Key left in ignition’ audible warning
- Electronically protected audio equipment
- Engine deadlock immobiliser
- Visible Vehicle Identification Number (VIN)
- Locking wheel bolts for alloy wheels
- Freewheeling door locks

### Remote control central locking

- Operates on doors, tailgate and fuel filler flap
- Deadlocking
- Central locking activation switch on driver’s door

## Model Specific Features/Option

	Option code*	Design	Ultimate
<b>Driver Information</b>			
10” Multimedia Pro		●	●
10” Digital Cluster		●	●
<b>Security</b>			
Remote control ultrasonic security alarm system	DAB13	£200	£200

\*Optional at extra cost including VAT.

# Convenience

**Standard Features** – The following features are standard across the entire Combo Life range. Specific features by model are outlined in the separate tabular information.

## Interior Convenience

- Front 12-volt electrical accessory socket
- Driver’s sun visor incorporating vanity mirror with cover
- Dipping rear-view mirror
- Steering wheel mounted audio controls
- Front and rear USB connection

## Interior Storage

- Two fascia-mounted drinks holders
- Two drinks holders in centre console
- Large open storage pocket behind infotainment screen
- Interior courtesy light
- Front map reading lights
- Luggage compartment lighting
- Small open storage compartment behind gear knob
- Two front large and small door pockets
- Two rear door pockets
- Open storage compartment below glovebox
- Full-width overhead storage shelf with ambient lighting

## Luggage Area

- Luggage compartment cover
- Illuminated load area
- Fully carpeted load area
- Interior tailgate handle
- Four load restraint lashing eyes
- Twin gas-assisted tailgate struts

## Interior Lighting

- Central front courtesy light
- Central rear courtesy light
- Fade up/fade down

## Model Specific Features

	Option code	Design	Ultimate
<b>Interior Convenience</b>			
Fold-flat front passenger seat with armrest		●	●
Electronic parking brake (EV only)		●	●
Manual parking brake		●	
Two foldable tables with cupholders		●	●
Front-seat back pockets		●	●

# Convenience

**Standard Features** – The following features are standard across the entire Combo Life range. Specific features by model are outlined in the separate tabular information.

## Heating and Ventilation

- Air recirculation facility
- Cabin particulate filter – Removes dust, airborne particles and pollen
- Four-speed fan
- Illuminated controls
- Four adjustable facia vents
- Windscreen demist vents
- Side window demist vents
- Rear heating duct

## Exterior Convenience

### Door mirrors

- Twin electrically adjustable/heated door mirrors

### Windows

- Solar heat-absorbing windscreen
- Electrically operated front and rear windows with safety autoreverse and one-touch up/down facility
- Tailgate with heated window and wash/wipe facility

## Model Specific Features

	Option code	Design	Ultimate
<b>Heating and Ventilation</b>			
Air conditioning		●	
Dual-zone electronic climate control			●
<b>Exterior Convenience</b>			
Electrically foldable door mirrors			●
Electric heated door mirrors		●	●
Rear tailgate with heating system and wiper		●	
Dark tinted rear tailgate window with heating system and wiper			●
Roof rails*		●	●

\*Please note, roof rail design may differ from that illustrated within this guide. Please consult your Retailer for details.

# Exterior Style and Lighting

**Standard Features** – The following features are standard across the entire Combo Life range.  
Specific features by model are outlined in the separate tabular information.

## Exterior Styling

- Chrome-effect front grille bar
- Body-colour door handles
- Body-colour bumpers and sliding rail cover

## Exterior Lighting

- Automatic lighting control
- Front fog lights
- LED side repeat indicators
- Lights-on audible warning – When driver’s door is opened an audible warning sounds to alert the lights have been left on
- Manual headlight beam levelling. Use to adapt headlight range to the vehicle load to prevent dazzling
- Rear fog light
- Reversing light
- Hazard warning lights

## Model Specific Features

	Option code	Design	Ultimate
<b>Exterior Styling</b>			
Dark-tinted rear windows			●
Painted shiny black side protection mouldings			●
Black side protection mouldings		●	
Shiny black painted door mirrors		●	●
<b>Exterior Lighting</b>			
Matrix LED Headlights		●	●

# Infotainment

## Standard Features

### Multimedia with 10-inch touchscreen Standard on Design and Ultimate models

#### Onboard features:

- AM/FM stereo radio • DAB Digital radio
- RDS with Traffic Programme • Four speakers

#### Media connections:

- Apple CarPlay • Android Auto™
- Smartphone projection
- 2x USB Type C Connections

#### Mobile phone portal:

- Bluetooth® connectivity
- Vehicle microphone
- Handsfree calls via steering wheel controls
- Phone book access

### Vauxhall Connect\*

#### Standard on Combo Life Electric Design and Ultimate models

#### e-Call and b-Call:

Help when you need it, 24/7, 365 days a year, that's what you get with new Vauxhall Connect. In an emergency or breakdown, you'll be put in touch with a trained advisor, with just the touch of a button.

#### Live Navigation Plus and more:

You can also access live navigation services, receive regular vehicle diagnostic info plus there's a host of remote convenience features available through the MyVauxhall app.

#### Additional features:

- 10-inch colour touchscreen
- Steering wheel mounted audio controls
- Flexible roof-mounted aerial

- **Peace of mind:** emergency call, breakdown call and regular vehicle status and information
- **Convenience:** remote functions (e.g. lock/unlock the door).
- **Our additional services for electric vehicles:** trip planning, remote settings or public charging solutions – we keep you going!
- **Smart driving:** enjoy a relaxed ride thanks to live navigation and trip management
- **Traffic alerts:** Live Navigation Plus introduces speed camera, traffic light camera and accident hotspot alerts



Please note that compatibility and certain functions may be different depending on the type of device and operating system you're using with the Multimedia systems. Apple CarPlay is a trademark of Apple Inc. Apple and iPhone are trademarks of Apple Inc., registered in the U.S. and other countries. Android is a trademark of Google Inc, also registered in the U.S. and other countries. \*Services may require a subscription/fee and are subject to mobile network coverage and availability. Standard on models with Satellite Navigation only.

Please note, Android smartphone projection illustrated on 8-inch colour touchscreen on Multimedia Navi Pro audio unit.

# Interior Styling and Comfort

## Design



### Steering wheel:

- Two-spoke Polyurethane foam design

### Seat trim:

- Mistral grey with tiles fabric seat trim inserts

### Instruments:

- 10-inch colour instrument display
- 10-inch Digital Cluster
- Chrome-effect instrument rings

### Front seating:

- Driver's seat (six-way adjustable):
  - Height – Reach – Backrest
  - Manual lumbar adjustment – Armrest
  - Under seat storage – Head restraint
- Passenger's Seat (four-way adjustable):
  - Reach – Backrest – Head restraint
  - Fold flat facility

## Ultimate



### Steering wheel:

- Two-spoke heated leather design

### Seat trim:

- Mistral Grey with tiles fabric seat trim inserts

### Instruments:

- 10-inch colour instrument display
- 10-inch Digital Cluster
- Chrome-effect instrument rings

### Front seating:

- Driver's seat (six-way adjustable):
  - Height – Reach – Backrest
  - Manual lumbar adjustment – Armrest
  - Under seat storage – Head restraint
- Passenger's Seat (four-way adjustable):
  - Reach – Backrest – Head restraint
  - Fold-flat facility



# Interior Styling and Comfort – Rear seating



## Model Specific Features

	Option code	Design	Ultimate
<b>Rear Seating</b>			
Height-adjustable and removable head restraints		●	●
Second-row three-person layout 1/3 – 2/3 rear folding seats		●	
Second-row three-person layout 33/33/33 individual split-folding second-row seats with fold flat facility			●
Third-row two-person individual removable seats		XL only	

# Exterior Colours

**Arctic White (POPR)\***  
Solid paint

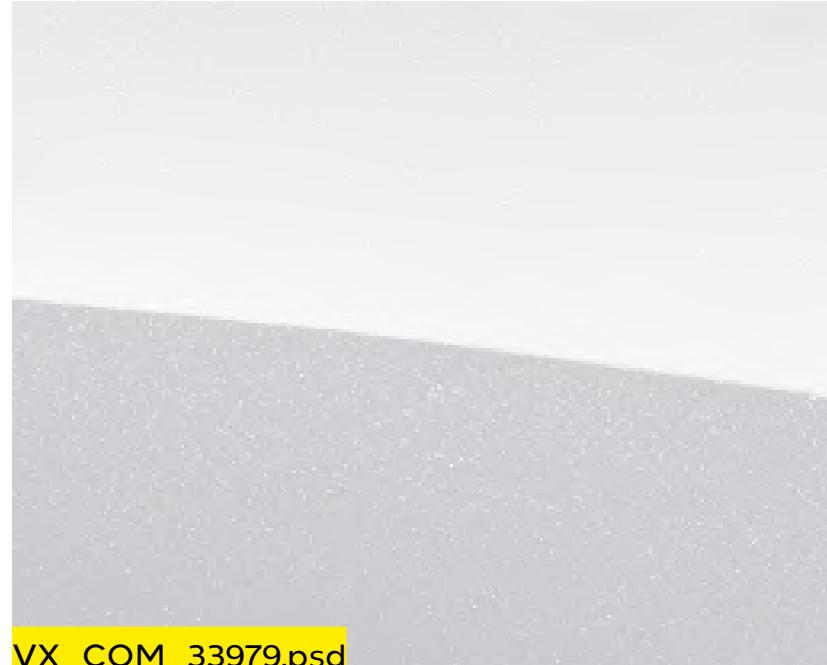

**Sirkka Green (M04Q)\*\***  
Two-coat metallic paint £570

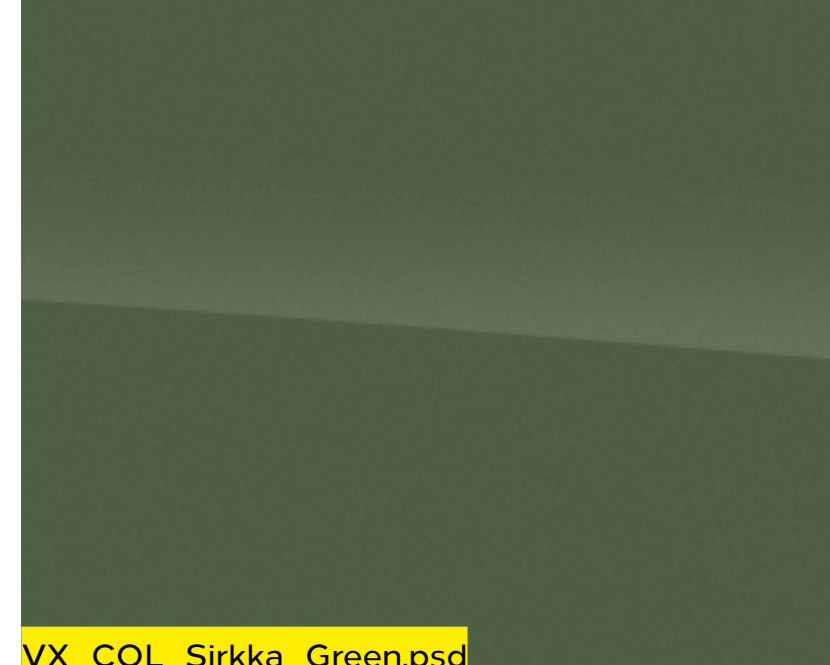

**Kiama Blue (ONM6)\*\***  
Two-coat metallic paint £570

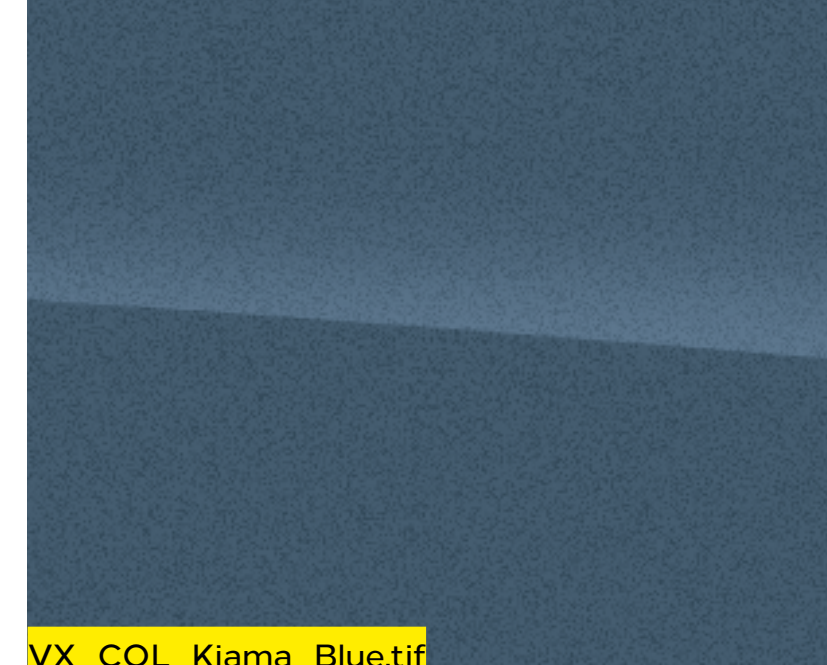

**Contrast Grey (MOF4)\*\***  
Two-coat metallic paint £570



**Carbon Black (M09V)\*\***  
Two-coat metallic paint £570

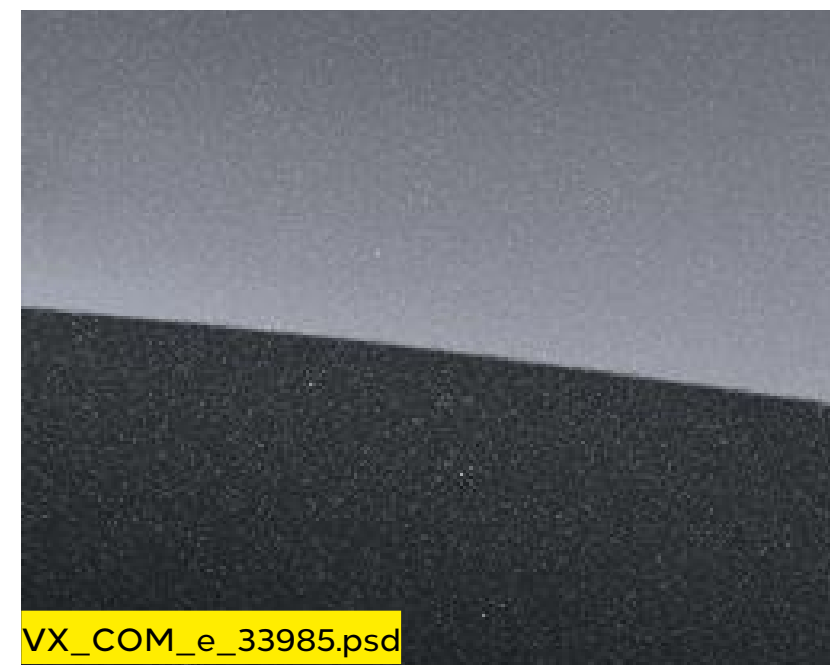



The colours reproduced may vary slightly from the actual paint colour. As a result they should be used as a guide only. Your Vauxhall Retailer has a comprehensive display of our paint samples.

\*Standard exterior paint. \*\*Optional at extra cost including VAT.

# Wheels and Tyres

## Model Specific Features/Option

	Option code	Design	Ultimate
 <p><b>16-inch steel wheels with full hubcap</b></p> <ul style="list-style-type: none"> <li>• 205/60 R 16 tyres</li> <li>• Emergency tyre inflation kit (in lieu of spare wheel)</li> </ul> <p>VX_COM_28612_RRY_JobOnly.psd</p>		●	
 <p><b>16-inch seven-spoke alloy wheels</b></p> <ul style="list-style-type: none"> <li>• 205/60 R 16 tyres</li> <li>• Emergency tyre inflation kit (in lieu of spare wheel)</li> </ul> <p>VX_COM_28555_RRZ_JobOnly.psd</p>			●
 <p><b>17-inch seven-spoke alloy wheels</b></p> <ul style="list-style-type: none"> <li>• 205/60 R 16 tyres</li> <li>• Emergency tyre inflation kit (in lieu of spare wheel)</li> </ul>	<b>DZG7</b>		<b>TBC</b>

# Performance, Fuel Economy and Emissions

	Performance (manufacturer's figures)		Fuel economy mpg (litres/100km)#		CO <sub>2</sub> emissions g/km#		Vehicle Excise Duty*		BiK rates from - 2023/24 tax year
	Maximum speed (mph)	Acceleration 0 - 62mph (sec)	Combined Low	Combined High	Combined Low	Combined High	First year rate	Standard rate	
<b>5-seat</b>									
<b>1.5 (100PS) Turbo D</b>	107	12.7	48.7 (5.9)	57.6 (4.9)	143	160	£255	£180	33%
<b>1.5 (130PS) Turbo D automatic</b>	114	tba	45.5 (6.2)	54.3 (5.2)	148	170	£255	£180	33%
<b>XL 7-seat</b>									
<b>1.5 (100PS) Turbo D</b>	106	13.0	47.8 (5.9)	57.6 (4.9)	146	160	£255	£180	33%
<b>1.5 (130PS) Turbo D automatic</b>	114	tba	54.3 (5.2)	45.5 (6.2)	152	170	£645	£180	34%

<No intersecting link>

#Figures shown are for comparison purposes and should only be compared to the fuel consumption and CO<sub>2</sub> values of other cars tested to the same technical standard. The fuel consumption achieved, and CO<sub>2</sub> produced, in real world conditions will depend upon a number of factors including, but not limited to: the accessories fitted (pre and post registration); variations in weather; driving styles and vehicle load. The WLTP (Worldwide Harmonised Light Vehicles Test Procedure) is used to measure fuel consumption and CO<sub>2</sub> figures. The CO<sub>2</sub> figures display a range to reflect the highest value for the highest emitting version with all available options added, through to a minimum value to represent the lowest emitting version in standard specification. \*Correct at time of publication.

# Combo Life Electric Specifications\*

## Single-speed electronic drive selector

As the motor is an all-electric single-speed drive unit, there is no need for multiple gears. Instead, the shifter lets the driver select from the following:

- Park
- Reverse
- Neutral
- Drive
- Braking (for increased regenerative braking)

## Drive Mode Selector

The driver can determine the driving style through selecting one of the following modes:

- **Power:** with high power reserves for the highest top speed and torque. Recommended at full capacity
- **Normal:** for a balanced drive that offers a compromise between performance and energy efficiency. WLTP range is validated in this mode
- **ECO:** for maximum range and energy efficiency. The ECO mode deactivates all unnecessary energy-consuming features and reduces the top speed, torque and overall performance

## Braking

### Energy recuperation

The regenerative braking system works when the vehicle is in motion, energy created by the resistance of the brakes against the drivetrain is converted into DC voltage to partially recharge the battery. The driver can also engage braking mode through the drive selector to increase the level of energy recuperation.

### Single foot driving experience

The system not only utilises the energy when the brakes are being used, but also engages when the vehicle is coasting, recovering more energy and enabling single foot driving as the brakes automatically engage when the throttle pedal is released.

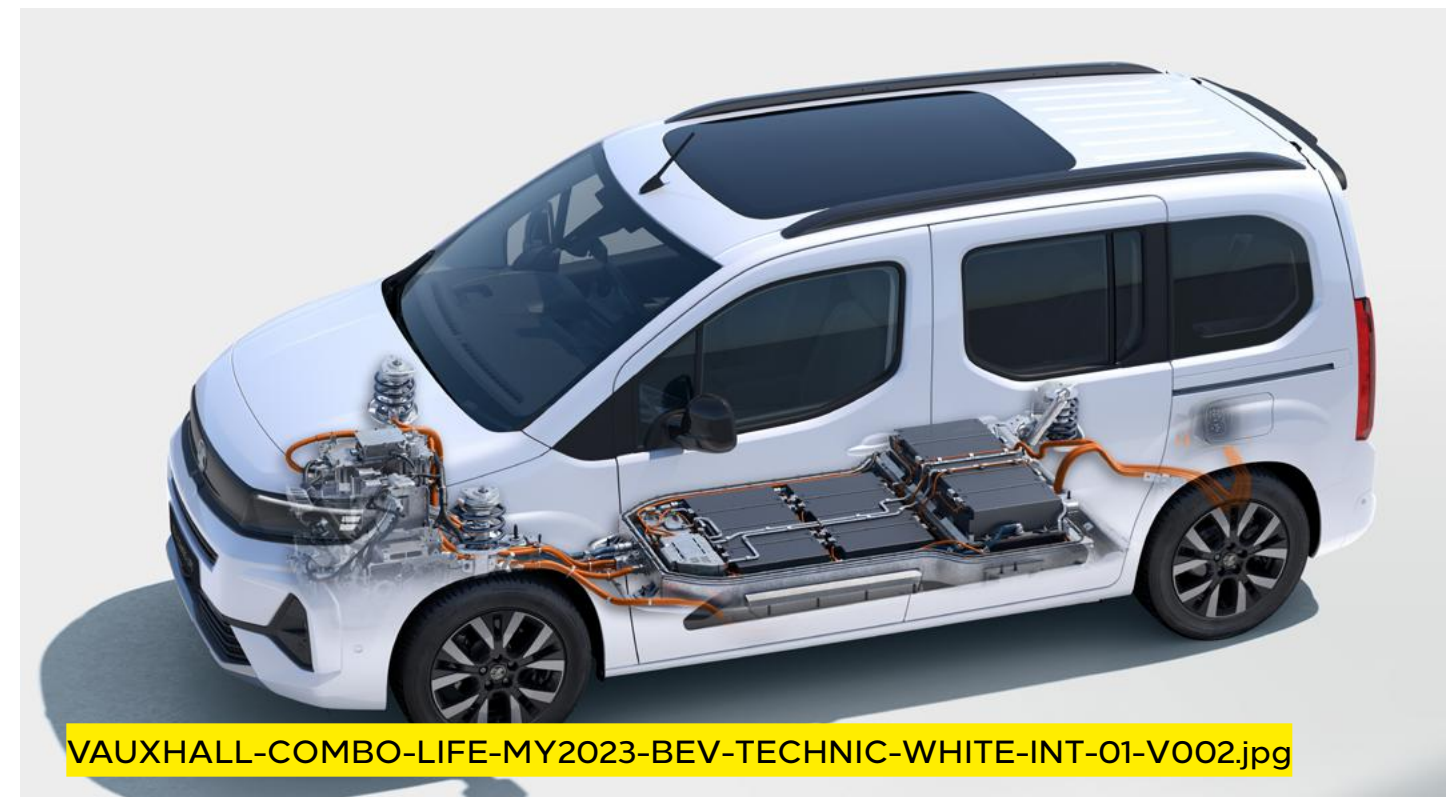

Drivetrain		
CO <sub>2</sub> emissions	0g/km	
Maximum power	100kW (136PS)	
Maximum torque	260Nm (192lb. ft.)	
Acceleration 0 – 62mph	11.7 sec	
Maximum speed	81mph	
Transmission	Automatic electric drive with fixed gear ratio	
Service interval	Every 25,000 miles or 2 years (whichever comes sooner) Initial inspection at 12,500 miles or 1 year (whichever comes sooner)	
Electric range	199 miles (WLTP preliminary)	
Weights kg		
	<b>5-seat</b>	<b>XL 7-seat</b>
Gross vehicle weight	2366 – 2387	2376 – 2396

The Combo Life Electric is a battery electric vehicle requiring mains electricity for charging. Range data given has been determined according to WLTP test procedure methodology. The figures shown are intended for comparability purposes only and should only be compared to other cars tested to the same technical standard. The range you achieve under real world driving conditions will depend upon a number of factors, including but not limited to: the accessories fitted (pre and post registration); charging frequency; personal driving style; vehicle load and route characteristics; variations in weather; heating/air conditioning; pre-conditioning and battery condition. For more information, contact your local Vauxhall Retailer.

\*Provisional data.

# Combo Life Electric Specifications\*

## Charging

Combo Life Electric comes fitted with an 7.4kW on-board charger and mode 3 cable. An 11kW on-board charger is available as an extra cost option at **£360 inc VAT**.

The charging flap's Padlock LED lights up when the cable is correctly plugged in and locked and then acts as a user interface to show the charging status via coloured LED lights:

- **White:** welcome light that helps to light up the area, especially useful in dark conditions
- **Flashing green:** charging in progress
- **Solid green:** charging complete
- **Solid blue:** delayed charging toggled; changes to flashing green when charging commences
- **Solid red:** malfunction

The driver may also choose from two settings:

- **Immediate charging (the standard setting):** Starts charging as soon as the vehicle is docked for charging
- **Delayed charging:** This is especially useful for when cheaper electric rates are desired, e.g. charging at night. Simply enter a charging start time

Please note, EV range assumes that vehicle has been pre-conditioned prior to journey. This function can be accessed either via MyVauxhall App (standard with all Combo Life Electric models or with optional Navi Pro).

Charging		
Supply	Socket	Charge Time (0 - 100%)
AC current - Domestic 3 pin socket (2.3kW)	Type 2	22h 30m
AC current - Home wallbox or public charger (7kW)	Type 2	6h 43m
AC current - Public charger (11kW)**	Type 2	4h 50m
DC current - Rapid charger (100kW)	CCS	38m (0 - 80%)

Battery	
Battery capacity	50kWh
AC on-board charger speed (standard)	7.4kW
WLTP Range (Combined)	TBC
WLTP Range (City)	TBC
Energy consumption (Combined low/high)	TBC
Battery warranty	8 years/100,000 miles/70% capacity



The Combo Life Electric is a battery electric vehicle requiring mains electricity for charging. Range data given has been determined according to WLTP test procedure methodology. The figures shown are intended for comparability purposes only and should only be compared to other cars tested to the same technical standard. The range you achieve under real world driving conditions will depend upon a number of factors, including but not limited to: the accessories fitted (pre and post registration); charging frequency; personal driving style; vehicle load and route characteristics; variations in weather; heating/air conditioning; pre-conditioning and battery condition. For more information, contact your local Vauxhall Retailer.

\*Provisional data. \*\*Requires optional 11kW on board charger.

# Combo Life Specifications

## Transmission

**Six-speed manual gearbox**  
1.5 (100PS) Turbo D models

### **Eight-speed automatic transmission**

1.5 (130PS) Turbo D models

Replacing the traditional lever, the automatic transmission selection-mode dial/drive wheel is an innovation solution that is both elegant and intuitive. By simply twisting the dial, the following modes can be selected:

- Park, for when the vehicle is stationary and the wheels are locked
- Drive, for automatic forward motion
- Neutral, for when the vehicle is stationary, wheels are free
- Reverse, for automatic backward motion

## Fuel tank capacity

– 50 Litres (10.9 gallons) – Diesel models

## AdBlue® Tank Capacity

– 17 Litres (3.7 gallons)

## Steering

Turning circle (kerb-to-kerb)

- 11.0m (36 ft) Life models
- 11.8m (38.7 ft) Life XL models

## Weights and Towing Data kg

	Gross vehicle weight	Maximum towing weights Trailer with brakes (without brakes)
<b>5-seat</b>		
<b>1.5 (100PS) Turbo D</b>	2095	1300 (750)
<b>1.5 (130PS) Turbo D automatic</b>	tba	tba
<b>XL 7-seat</b>		
<b>1.5 (100PS) Turbo D</b>	2285	1100 (750)
<b>1.5 (130PS) Turbo D automatic</b>	tba	tba

<No intersecting link>

**Please note:** Gross vehicle weight is the total permissible weight of the vehicle including passengers and their luggage. The maximum roof rack loading should not exceed 100kg on all models. The maximum towing weights are based on the ability of the car, with two occupants of 75kg each, to restart on a 12% gradient, which is approximately 1 in 8.3, at sea level. The permitted trailer load applies up to the specified incline and up to an altitude of 1000 metres above sea level. The permissible gross train weight decreases by 10% for every 1000 metres of additional altitude. Any extra weight, such as luggage or additional passengers, should be deducted from the maximum towing weight. Always fit Vauxhall towing attachments and accessories available from your Vauxhall Retailer. They are designed specifically for Vauxhall models and carry a 12-month guarantee. During trailer towing do not exceed a maximum speed of 60mph. This speed limit is also applicable in countries with higher permitted speeds for trailer-vehicle combinations. Pay attention to the local speed limits. For trailers with low driving stability and caravans the use of an oscillation damper is strongly recommended.

# Combo Life Electric Dimensions and Capacities

All measurements in mm (inches) unless stated otherwise.

Loadspace Dimensions	5-seat	XL 7-seat
Maximum load floor length – passenger seat folded	2700 (106.3)	3050 (120.1)
Maximum load length – behind front seats	1880 (74.0)	2230 (87.8)
Maximum load length – behind second-row seats	914 (36.0)	1350 (53.1)
Maximum load length – behind third-row seats	236 (9.3)	418 (16.5) – 566 (22.3)
Maximum load height	1200 (47.2)	1119 (44.0)
Maximum load width	1195 (47.0)	1195 (47.0)
Maximum width between wheel arches	1149 (45.2)	1129 (44.4)
Loading height	584 (23.0)	620 (24.4)
Maximum tailgate aperture width	1087 (42.8) – 1241 (48.9)	1087 (42.8) – 1241 (48.9)
Maximum tailgate aperture height	1126 (44.3)	1126 (44.3)
Maximum height under raised tailgate	1892 (74.5)	1892 (74.5)
Maximum side-access aperture width	640 (25.2) – 745 (29.3)	640 (25.2) – 745 (29.3)
Maximum side-access aperture height	1145 (45.1)	1145 (45.1)
<b>Luggage Capacities* – Litres (cu.ft.)</b>		
Behind front-row seats to glassline	1414 (49.9)	1672 (59.0)
Behind front-row seats to roof	2126 (75.1)	2693 (95.1)
Behind second-row seats to glassline	597 (21.1)	850 (30.0)
Behind second-row seats to roof	983 (34.7)	1538 (54.3)
Behind third-row seats	571 (20.2)	806 (28.5)

\*Measured using the ECIE method.

5-seat

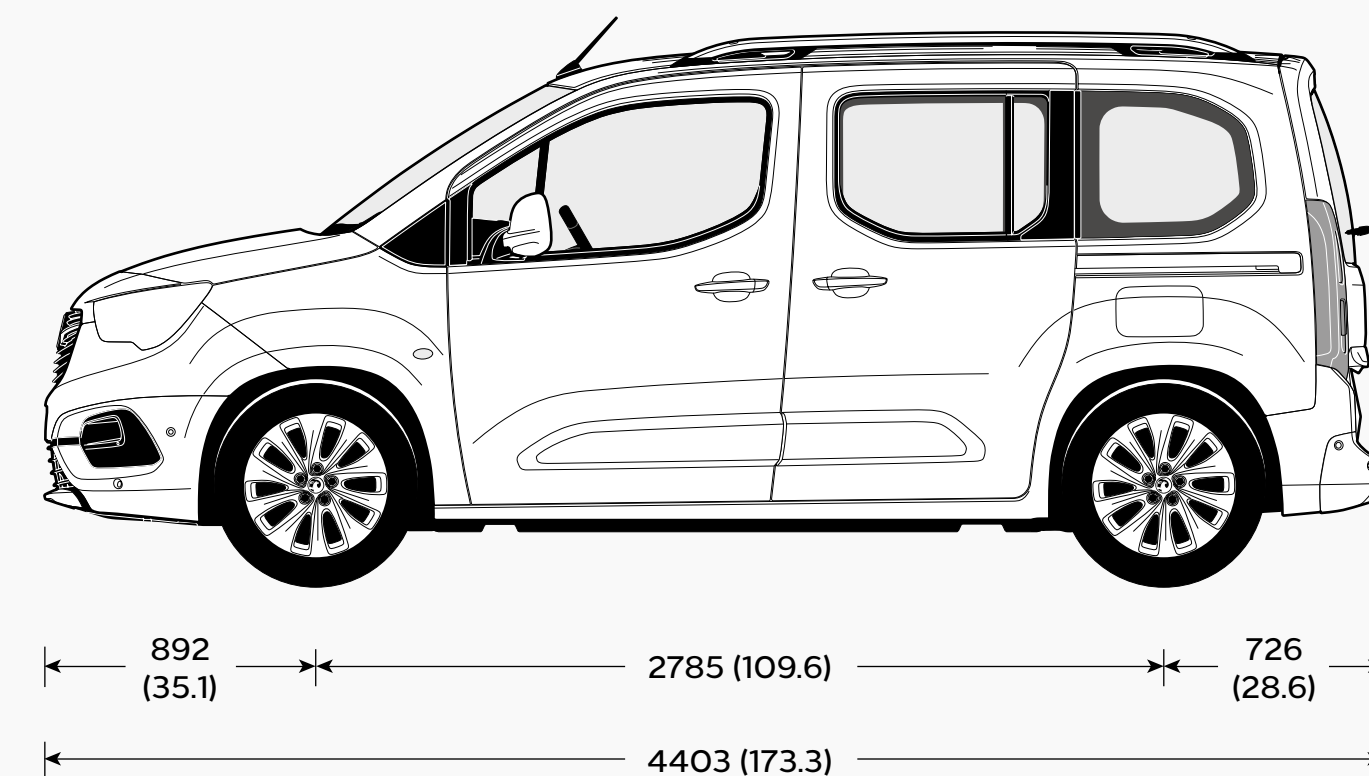
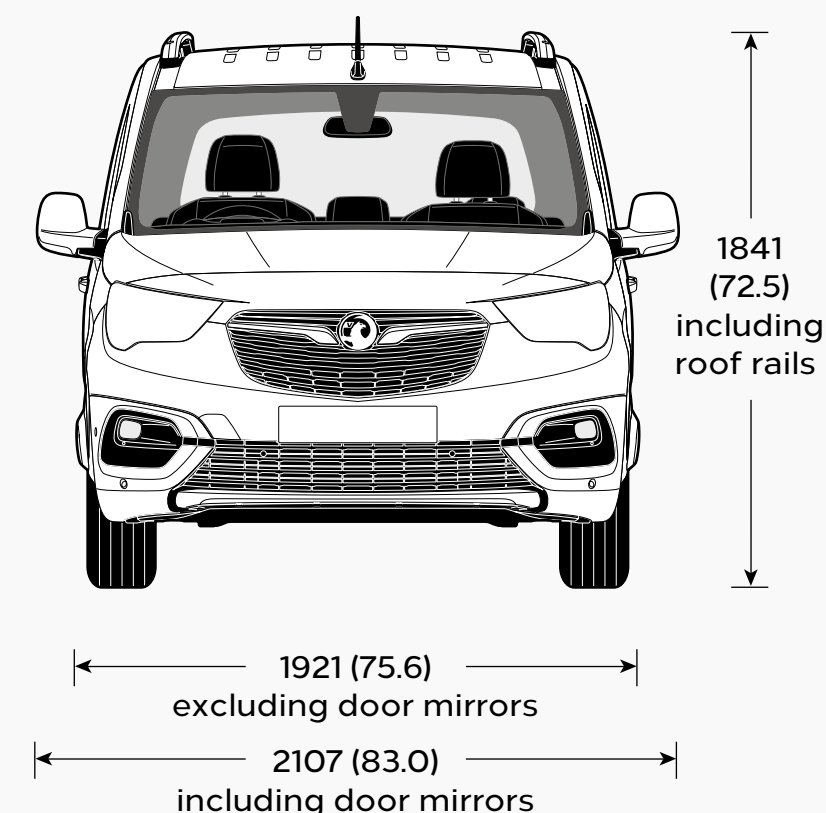

XL 7-seat

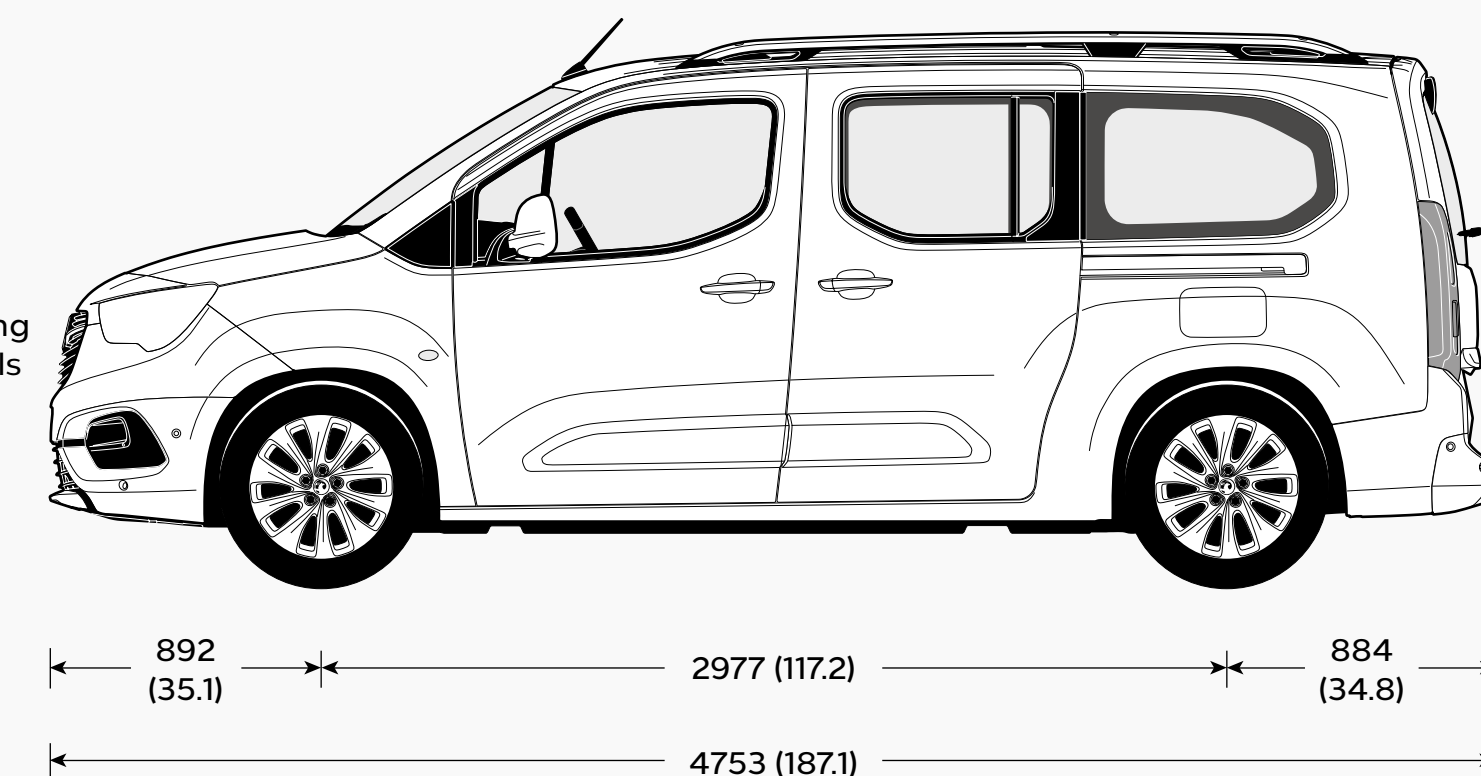
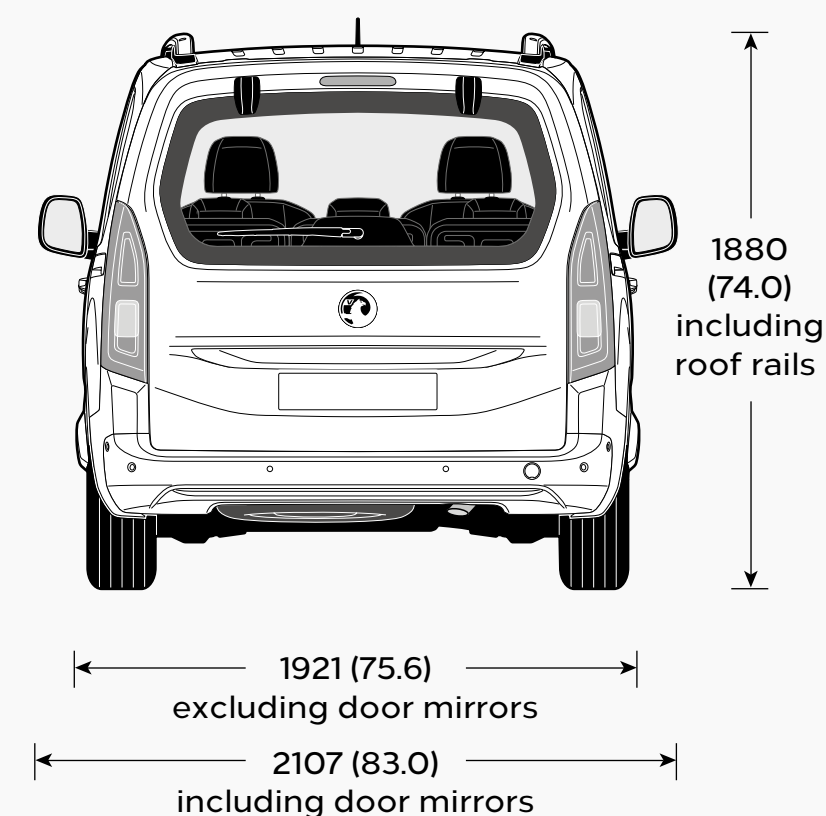



# Accessories

Safety	Total (inc. VAT)	Protection	Total (inc. VAT)	Transport solutions	Total (inc. VAT)	Electric	Total (inc. VAT)
Spare wheel kit with 16-inch emergency wheel, tool kit and mounting basket	£247	Carpet mats (set of 4)	£61	Roof base carrier (set of 2 bars)		Mode 2 emergency charging cable (Type G – UK domestic plug)	£584
Philips ADR620 dash cam	£109	Carpet mats for third row seats (set of 2)	£25	– Without roof rails <sup>2</sup>	£180	Mode 3 charging cable	
Front parking sensors	£474	Rubber mats (set of 4)	£48	– With roof rails	£219	– 7.4kW	£331
Rear parking sensors	£455	Boot tray	£64	Additional roof base carrier (1 bar)		– 11kW	£371
Child seats <sup>1</sup>		Vertical cargo net	£21	– Without roof rails <sup>2</sup>	£105	– 22kW	£438
– Group 0 (0-13kg) – Britax Romer Baby Safe	£239	Dog guard – without sunroof	£282	<b>Roof carriers (requires base carrier)</b>		Cable bag	£49
– ISOFIX Base, Rear-facing for Britax Romer Baby Safe	£251	Dog guard – with sunroof	£248	Roof box – Thule Ocean 80	£164	Mode 2 universal charger UK kit (22kW)	£1,555
– Group 2/3 (15-36kg) – Britax Romer KIDFIX 2 R	£317	Rear splash guards	£97	Roof box – Thule Ocean 200	£374	Accessories for universal charger	
– Group 2/3 (15-36kg) – Britax Romer KIDFIX XP	£352	<b>Comfort</b>		Roof box – Thule Touring 200	£428	– Wall bracket	£105
– Group 3 (22-36kg) – Booster Seat without Seatback	£76	USB charger – 2 front and 2 rear ports	£28	Roof box – Thule Touring 700	£492	– Bag	£65
Safety Pack – first aid kit, hi-vis vest and warning triangle	£16	FlexConnect bracket	£33	Roof box – Thule Motion 800	from £426	– Safety lock	£20
Warning triangle	£9	FlexConnect hook	£37	Bike carrier – Thule FreeRide 532	£81	– Adapter Type 2	£318
Hi-vis safety vest – adult	£4	FlexConnect coat hanger	£41	Bike carrier – Thule Expert 298	£134	– Adapter Type 3c	£358
Hi-vis safety vest – child 3-6 years (42cm)	£4	FlexConnect folding table	£102	Surfboard carrier – Thule 833	£84	– Adapter (various)	£120
Hi-vis safety vest – child 7-12 years (52cm)	£4	FlexConnect iPad Mini holder	£127	Kayak carrier – Thule Hull-a-Port Pro 837	£234		
First aid kit	£15	FlexConnect iPad holder	£106	Ski/snowboard carrier			
Emergency seat belt cutter and hammer	£19	FlexConnect iPad Air holder	£106	– Thule Snow Pack 7324 (4 x pairs)	£147		
Fire extinguisher (1kg) with strap	£23	FlexConnect Samsung Galaxy 10.1 holder	£127	Ski/snowboard carrier			
Spare bulb kit – 11 x high-quality bulbs and 7 x fuses from Philips	£70	FlexConnect Samsung Galaxy 10.1 holder	£127	– Thule Snow Pack 7326 (6 x pairs)	£265		
		Privacy shades (set of 2) for:		<b>Towing</b>			
		– side rear windows (tilt/turn window)	£59	Swan's neck towing ball and			
		– side rear windows (electric window)	£59	13-track wiring loom			
		– quarter side rear windows (Life models)	£57	– Life models	£463		
		– quarter side rear windows (Life XL models)	£60	– Life XL models	£463		
		– rear window	£60	Tow bar with removable tow ball and			
		Cupholder organisers	£8-10	13-track wiring loom			
		Smoker's kit	£20	– Life models	£571		
		Fragrance diffuser	£24	– Life XL models	£567		
		Fragrance cartridge (various)	£18	13-pin to 7-pin adaptor	£30		

**Please note:** Prices shown are fully fitted and painted, where applicable and include VAT. Please check with your local Vauxhall Retailer for details. It is advisable to ensure your insurance policy is adequate to cover additional fitted accessories. Prices correct at time of publication.

<sup>1</sup>Restrictions apply to the use of child seats, please consult your vehicle user manual or Vauxhall Retailer. <sup>2</sup>A dedicated T-Track adapter (Thule 697-4 or Thule 697-6) is required for the installation of specific roof boxes, contact your local Vauxhall Retailer for details.

# Company Car Driver and Fleet Information

## Benefit in kind company car taxation\*

The car benefit charge will be the car's list price (including VAT, options and accessories fitted, delivery to Retailer and number plates, but excluding Vehicle Excise Duty and new vehicle first registration fee) multiplied by the percentage charge for the CO<sub>2</sub> emissions band in which the car falls (see table opposite). Multiply this figure by your personal income tax rate (20%\*\* for Basic Rate, 40%\*\* for Higher Rate) to calculate your annual benefit in kind tax liability.

### Generic example:

#### ELECTRIC vehicle: 0g/km CO<sub>2</sub>

On-the-road RRP	£27,305.00
Deduct: Vehicle Excise Duty	£0.00
New vehicle first registration fee	-£55.00
Effective list price	£27,250.00
Add: Optional two-coat metallic paint	£600.00
List price for tax purposes (P11D value)	£27,850.00
Car benefit charge 2023 – 24 tax year (2%)	£557.00
Benefit in kind tax liability	
Basic Rate (20%) tax payer	£111.40
Higher Rate (40%) tax payer	£222.80

\*Please note this Price Guide provides taxation information as a guide only. Vauxhall does not provide taxation guidance. Drivers should always take professional advice on their own tax position.

\*\*Excludes residents of Scotland.

### BiK for Scottish Residents

Effective 6 April 2018 the Scottish Government have introduced their own BiK taxation structure. This only applies to Company Car Drivers that are Scottish taxpayers. HMRC will determine whether or not an individual is a Scottish taxpayer based on where their main place of residence is.

#### The BiK rates for Scotland are:

- Over £12,570 – £14,732 Starter Rate 19%
- Over £14,732 – £25,688 Basic Rate 20%
- Over £25,688 – £43,662 Intermediate Rate 21%
- Over £43,662 – £150,000 Higher Rate 41%
- Above £150,000 Top Rate 46%

CO <sub>2</sub> emissions (g/km)	Electric range (miles)	Percentage of cars price to be taxed 2023 – 24 tax year
0	-	2%
1 – 50	130+	2%
1 – 50	70 – 129	5%
1 – 50	40 – 69	8%
1 – 50	30 – 39	12%
1 – 50	<30	14%

To calculate your own personal liability, search: **Vauxhall BiK**, or click the link below:

[Vauxhall BiK Tool](#)

### Fleet Toolbox

Discover the facts in our online Toolbox for both Company Car Drivers and Fleet Decision Makers. The Fleet Toolbox has a host of useful calculators, comparators, interactive listings and information.

Search Vauxhall Fleet Tools or click the link below:

[Vauxhall Fleet Tool Box](#)

## Contact Vauxhall Fleet

Please contact one of our dedicated sales teams who will be happy to help with your particular enquiry.

### Fleet Decision Makers

Depending on the size of your fleet of vehicles, we have a dedicated team to handle your enquiries. The lines are open Monday to Friday excluding Bank Holidays.

#### 1 – 24 vehicles

Call: 0203 885 4560 (8:30am – 5:00pm)

Email: [enquiries@stellantis-fleet.co.uk](mailto:enquiries@stellantis-fleet.co.uk)

#### 50+ vehicles

Call: 0203 885 4562 (8:30am – 5:00pm)

Email: [enquiries@vauxhallfleet.co.uk](mailto:enquiries@vauxhallfleet.co.uk)

### Special Vehicles (Police, Fire and Ambulance)

Call: 01582 409999

Email: [psvo@stellantis.com](mailto:psvo@stellantis.com)

# Further Information

## On-the-road prices

To eliminate uncertainty about hidden costs when buying a new car, Vauxhall publishes on-the-road recommended retail prices (RRP) and these are shown in the pricing tables within this price guide. These prices include VAT, number plates and delivery to Retailer of £900.00 (including £150.00 VAT), 12 months' Government Vehicle Excise Duty (see opposite for details) and the DVLA new vehicle first registration fee of £55.00.\*

**Please note:** The on-the-road recommended retail price (RRP) does not include fuel supplied by the Retailer, motor insurance or any other goods or services supplied by agreement between the Retailer and the customer.

## Price protection

Order a new Vauxhall for build in the current model year (as confirmed by your Retailer) for delivery no more than three months in advance and the price you are quoted is the price you pay. This is irrespective of any subsequent price rises between placing your order and delivery of your new car, but you must take delivery as soon as the car is available.

**Please note:** Vauxhall Motors Limited is not liable for price adjustments caused by Government changes in the rate of VAT (currently 20%), Vehicle Excise Duty, DVLA new vehicle first registration fee or by any other applicable legislation or regulations.

## In the event of an accident

Vauxhall Accident Management helps keep you mobile following an accident. Benefits include vehicle recovery, Vauxhall-approved repairs and contacting your insurer. For more details, visit [vauxhall.co.uk/AccidentManagement](http://vauxhall.co.uk/AccidentManagement)

## LEASYS

### Leasys UK

Leasys is the proud Business Contract Hire partner of Vauxhall and consequently, can provide quick vehicle delivery to keep your business mobile.

Specialised in Medium to Long-Term Leasing options and Fleet Management solutions for businesses of all sizes, [Leasys](#) lead mobility by offering sustainable and innovative solutions designed around customers, for a best-in-class experience. Their team of experts can personally support you and provide dedicated consultation.

[Leasys](#) is equally owned by Stellantis and Crédit Agricole Consumer Finance and is a member of the British Vehicle Rental and Leasing Association (BVRLA).

For further information, please contact your local Vauxhall Retailer or visit [leasys.com/uk](http://leasys.com/uk)

### Vehicle Excise Duty

The amount of Vehicle Excise Duty (road fund licence) payable on new cars varies depending on the level of carbon dioxide (CO<sub>2</sub>) emissions produced by the vehicle. CO<sub>2</sub> emissions are measured in grams per kilometre (g/km) travelled and divided into 13 charging bands shown in the table opposite.

A 'first year rate' of Vehicle Excise Duty is payable on all new cars and in subsequent years the amount payable reverts to the 'standard rate'. Also, for vehicles with a list price over £40,000, including factory-fitted options, an additional £390 is payable for the first five years of standard rate payments.

## Vehicle Excise Duty\*

Band	CO <sub>2</sub> emissions in grams per kilometre	First year rate Diesel	Standard rate Diesel	Standard rate Electric
A	0	£0	£0	£0
B	1 – 50	£10	£180	–
C	51 – 75	£30	£180	–
D	76 – 90	£130	£180	–
E	91 – 100	£165	£180	–
F	101 – 110	£185	£180	–
G	111 – 130	£210	£180	–
H	131 – 150	£255	£180	–
I	151 – 170	£645	£180	–
J	171 – 190	£1,040	£180	–
K	191 – 225	£1,565	£180	–
L	226 – 255	£2,220	£180	–
M	Over 255	£2,605	£180	–

\*Correct at time of issue.

# Further Information

## Customer Care Commitment

For added peace of mind, Vauxhall has an innovative Customer Care Commitment that offers the following:

- Three-year vehicle warranty consisting of a one-year/unlimited mileage manufacturer's warranty and a second and third year manufacturer's warranty with a 60,000 miles limitation
- Vauxhall Assistance for 12 months from first registration
- Six years' body panel anti-perforation warranty

**Please note:** Warranty is only available on vehicles sourced from Vauxhall Motors Limited. Terms and conditions apply – please see your Vauxhall Retailer for details.

## Vauxhall Assistance

Vauxhall Assistance is provided automatically with every new Vauxhall for 12 months from first registration and covers everything from accident assistance, roadside recovery and 'at home' service to flat tyres. For even more peace of mind, on fully electric models, the cover is extended\* to 3 years. Even more reason for you to stay calm and let us take care of everything should the need arise. With Vauxhall Assistance help is literally just a free\*\* phone call away, 24 hours a day, 365 days a year!

## Protecting the environment

Vauxhall's commitment to the environment is demonstrated by our products' many environmental awards. For even more information on Vauxhall's efforts to achieve an environmentally sustainable future, and how to dispose of your end-of-life vehicle, see [vauxhall.co.uk/recycling](https://www.vauxhall.co.uk/recycling)

## Vauxhall Care

This all-inclusive service package is available on Vauxhalls under 10 months old (from date of first registration).

This package offers complete peace of mind for the first 3 years of your Vauxhall's life with fixed monthly payments for the plan duration.

- **3 years' Vauxhall servicing** – covers first, second and third annual services. Including a brake-fluid change in the second service
- **2 years' Vauxhall Roadside Assistance** – first year from us
- **First years' MOT<sup>†</sup>** – free of charge by your local Vauxhall Retailer

For full terms and conditions and to sign up, visit: [vauxhall.co.uk/vauxhallcare](https://www.vauxhall.co.uk/vauxhallcare)

## Vauxhall Service Club

Vauxhall Service Club is available for all Vauxhall owners, and it's free to join. Members benefit from the following:

- 15% off Vauxhall Approved Accessories
- Vauxhall's aged 2-3 Years = 15% off parts and labour
- Vauxhall's aged over 3 Years = 25% off parts and labour
- Half price MOT's (NI excluded)
- Free pre-MOT test inspection (NI only)
- Fixed price AdBlue<sup>®</sup> Refills
  - Car = £14.99
  - Van = £24.99
- Access to the Vauxhall Accident Management Programme
- Online service booking available 24/7 with servicing appointments available within 3 days – [Book Online](#)
- Collection and delivery/onward mobility options
- Complimentary 'Wash and Vac' with all routine services<sup>††</sup>
- Vauxhall trained technicians
- Genuine Vauxhall parts
- Minimum 12 months warranty on parts and labour
- Regular newsletters with exclusive offers, discounts and competitions

Terms and conditions apply. To join visit: [vauxhall.co.uk/serviceclub](https://www.vauxhall.co.uk/serviceclub)

## Vauxhall Insurance with added reassurance

Comprehensive cover – Summary of benefits

- Competitive premiums
- Repairs by a Vauxhall-trained technician
- Genuine Vauxhall parts, guaranteed for five years when we repair your car within our Approved Repairer Network
- Free courtesy car as standard when using an Approved Repairer<sup>‡</sup>
- 24 hour claims helpline
- Personal Accident benefit
- Cover for audio equipment
- Windscreen cover

Call for a quote on **0330 678 1130<sup>††</sup>**

## For more product information

For further information on the Vauxhall range or location of your nearest Vauxhall Retailer please call **0800 026 0034**. Alternatively, details can be found on our website at [vauxhall.co.uk](https://www.vauxhall.co.uk)

For more information call **0800 026 0034**

For Fleet enquiries call **0203 476 2268**

Discover the full Vauxhall range at **[vauxhall.co.uk](https://www.vauxhall.co.uk)**

**Join us online**

The invoice price, including delivery to Retailer, factory-fitted options, accessories fitted by the Retailer and number plates, is subject to VAT. Some feature descriptions in this guide may refer to, and some illustrations may show, optional equipment not included in the standard delivery. The information contained in this guide was accurate at the time of publication. We reserve the right to make changes in design and equipment. Please note that Vauxhall Retailers are not the agents of Vauxhall Motors Limited and are not authorised to bind Vauxhall Motors Limited by any specific or implied undertaking or representation. It is advisable to ensure that your motor insurance policy provides adequate cover for additional fitted options and accessories. The colours in this guide are only approximate actual colours. Illustrated optional equipment is available at extra charge. Availability, technical features and equipment provided on our vehicles can vary by model. For precise information on the equipment provided on our vehicles, please contact your local Vauxhall Retailer.

**VAUXHALL**