

# INSIGNIA

## PRICE/SPECIFICATION GUIDE

1 January 2019 | Model Year 2019.5





**VAUXHALL**

British Brand since 1903

# INSIGNIA RANGE HIGHLIGHTS





DESIGN	OTR from £19,940
<i>Standard features include:</i>	
<b>Exterior convenience / styling:</b>	
<ul style="list-style-type: none"> <li>• 17-inch bi-colour structure wheels (1.6 diesel ecoTEC models)</li> <li>• 17-inch five twin-spoke alloy wheels (excluding 1.6 diesel ecoTEC models)</li> <li>• Automatic lighting control</li> <li>• Electrically operated front / rear windows</li> <li>• Electrically adjustable / heated door mirrors</li> </ul>	
<b>Interior convenience / styling:</b>	
<ul style="list-style-type: none"> <li>• Air conditioning</li> <li>• Leather-covered steering wheel</li> <li>• Steering wheel audio / phone / cruise controls</li> <li>• Steering column adjustable for reach / rake</li> </ul>	
<b>Infotainment:</b>	
<ul style="list-style-type: none"> <li>• Multimedia audio system                             <ul style="list-style-type: none"> <li>– 7-inch colour touchscreen</li> <li>– Bluetooth® / Apple CarPlay™ / Android Auto™</li> </ul> </li> <li>• Seven speakers (five front, two rear)</li> </ul>	
<b>Safety / security:</b>	
<ul style="list-style-type: none"> <li>• Electronic Stability Programme (ESP)</li> <li>• Anti-lock Braking System (ABS)</li> <li>• Driving Assistance Pack One</li> <li>• Six airbags</li> <li>• Keyless start</li> <li>• Security alarm system (Thatcham approved, T1)</li> </ul>	

DESIGN NAV	OTR from £20,740
<b>Design Nav models additional feature:</b>	
<ul style="list-style-type: none"> <li>• Multimedia Navi system                             <ul style="list-style-type: none"> <li>– Fully integrated sat nav system</li> <li>– 7-inch colour touchscreen</li> </ul> </li> </ul>	
<i>Structure wheel</i>	
<i>Alloy wheel</i>	

SRI	OTR from £22,710
<i>Features over Design:</i>	
<b>Exterior convenience / styling:</b>	
<ul style="list-style-type: none"> <li>• 17-inch five twin-spoke alloy wheels</li> <li>• Front fog lights</li> <li>• Rear spoiler (Grand Sport models)</li> <li>• Rain-sensitive windscreen wipers</li> <li>• Silver-effect roof rails (Sports Tourer models)</li> <li>• Front and rear parking sensors</li> </ul>	
<b>Interior convenience / styling:</b>	
<ul style="list-style-type: none"> <li>• AGR active front seats</li> <li>• Sports pedals</li> <li>• Dual-zone electronic climate control</li> <li>• Illuminated vanity mirrors</li> <li>• Storage pockets on front seat backs</li> <li>• Ambient LED lighting in front doors</li> <li>• Twin rear USB sockets</li> <li>• Auto-dimming rear-view mirror</li> </ul>	



SRI NAV	OTR from £23,500
<b>SRI Nav models additional feature:</b>	
<ul style="list-style-type: none"> <li>• Multimedia Navi system                             <ul style="list-style-type: none"> <li>– Fully integrated sat nav system</li> <li>– 7-inch colour touchscreen</li> </ul> </li> </ul>	
	

SRI VX-LINE NAV	OTR from £24,720
<i>Features over SRI:</i>	
<b>Exterior convenience / styling:</b>	
<ul style="list-style-type: none"> <li>• 17-inch five twin-spoke alloy wheels (1.6 diesel manual models)</li> <li>• 18-inch five-spoke alloy wheels (excluding 1.6 diesel manual and 1.6 (200PS) Turbo models)</li> <li>• 20-inch five twin-spoke alloy wheels (1.6 (200PS) Turbo models)</li> <li>• VX-Line Styling Pack                             <ul style="list-style-type: none"> <li>– Sports-style front and rear bumpers</li> <li>– Side sills</li> <li>– Dual visible exhaust tailpipes (Grand Sport 1.6 (200PS) Turbo and 2.0 (210PS) BiTurbo D models). Dual imitation exhaust bezels (Sports Tourer 1.6 (200PS) Turbo and 2.0 (210PS) BiTurbo D models (not available on 1.5 (165PS) Petrol, 1.6 (110/136PS) and 2.0 (170PS) Diesel models)</li> </ul> </li> </ul>	
<b>Interior convenience / styling:</b>	
<ul style="list-style-type: none"> <li>• Heated, flat-bottom, leather-covered VX-Line steering wheel</li> <li>• Dark fabric headlining</li> </ul>	
<b>Infotainment:</b>	
<ul style="list-style-type: none"> <li>• Multimedia Navi system                             <ul style="list-style-type: none"> <li>– Fully integrated sat nav system</li> <li>– 7-inch colour touchscreen</li> </ul> </li> </ul>	
	
	



# INSIGNIA RANGE HIGHLIGHTS



DESIGN	OTR from £19,940
<i>Standard features include:</i>	
<b>Exterior convenience / styling:</b>	
<ul style="list-style-type: none"> <li>• 17-inch bi-colour structure wheels (1.6 diesel ecoTEC models)</li> <li>• 17-inch five twin-spoke alloy wheels (excluding 1.6 diesel ecoTEC models)</li> <li>• Automatic lighting control</li> <li>• Electrically operated front / rear windows</li> <li>• Electrically adjustable / heated door mirrors</li> </ul>	
<b>Interior convenience / styling:</b>	
<ul style="list-style-type: none"> <li>• Air conditioning</li> <li>• Leather-covered steering wheel</li> <li>• Steering wheel audio / phone / cruise controls</li> <li>• Steering column adjustable for reach / rake</li> </ul>	
<b>Infotainment:</b>	
<ul style="list-style-type: none"> <li>• Multimedia audio system                             <ul style="list-style-type: none"> <li>– 7-inch colour touchscreen</li> <li>– Bluetooth® / Apple CarPlay™ / Android Auto™</li> </ul> </li> <li>• Seven speakers (five front, two rear)</li> </ul>	
<b>Safety / security:</b>	
<ul style="list-style-type: none"> <li>• Electronic Stability Programme (ESP)</li> <li>• Anti-lock Braking System (ABS)</li> <li>• Driving Assistance Pack One</li> <li>• Six airbags</li> <li>• Keyless start</li> <li>• Security alarm system (Thatcham approved, T1)</li> </ul>	

DESIGN NAV	OTR from £20,740
<b>Design Nav models additional feature:</b>	
<ul style="list-style-type: none"> <li>• Multimedia Navi system                             <ul style="list-style-type: none"> <li>– Fully integrated sat nav system</li> <li>– 7-inch colour touchscreen</li> </ul> </li> </ul>	
<i>Structure wheel</i>	
<i>Alloy wheel</i>	

TECH LINE NAV	OTR from £23,300
<i>Features over Design:</i>	
<b>Exterior convenience / styling:</b>	
<ul style="list-style-type: none"> <li>• 17-inch five twin-spoke alloy wheels</li> <li>• Rain-sensitive windscreen wipers</li> <li>• Front and rear parking sensors</li> <li>• Silver-effect roof rails (Sports Tourer models)</li> </ul>	
<b>Interior convenience / styling:</b>	
<ul style="list-style-type: none"> <li>• Dual-zone electronic climate control</li> <li>• AGR active drivers seat</li> <li>• Twin rear USB sockets</li> <li>• Auto-dimming rear-view mirror</li> <li>• Driver's seat tilt and lumbar adjustment</li> <li>• Front passenger's seat height adjustment</li> </ul>	
<b>Infotainment:</b>	
<ul style="list-style-type: none"> <li>• Multimedia Navi system                             <ul style="list-style-type: none"> <li>– Fully integrated sat nav system</li> <li>– 7-inch colour touchscreen</li> </ul> </li> </ul>	
	

ELITE NAV	OTR from £26,530
<i>Features over Tech Line Nav:</i>	
<b>Exterior convenience / styling:</b>	
<ul style="list-style-type: none"> <li>• 17-inch five twin-spoke alloy wheels (1.6 diesel manual models)</li> <li>• 18-inch bi-colour alloy wheels (excluding 1.6 diesel manual, 1.6 (200PS) Turbo and 2.0 (210PS) BiTurbo D 4X4 models)</li> <li>• 20-inch five twin-spoke alloy wheels (1.6 (200PS) Turbo and (210PS) BiTurbo D 4X4 models)</li> <li>• IntelliLux LED® matrix headlights</li> <li>• Front fog lights</li> <li>• Dark-tinted rear windows</li> <li>• Torque vectoring system (4X4 models)</li> </ul>	
<b>Interior convenience / styling:</b>	
<ul style="list-style-type: none"> <li>• AGR active front seats</li> <li>• Leather seat facings</li> <li>• Heated front seats</li> <li>• 8-inch colour information display</li> </ul>	
<b>Infotainment:</b>	
<ul style="list-style-type: none"> <li>• Multimedia Navi Pro system                             <ul style="list-style-type: none"> <li>– Fully integrated European sat nav system</li> <li>– 8-inch colour touchscreen</li> </ul> </li> <li>• Bose® premium sound system (2.0 (210PS) BiTurbo D 4X4 models)</li> </ul>	
<i>17-inch</i>	
<i>18-inch</i>	
<i>20-inch</i>	

# INSIGNIA RANGE HIGHLIGHTS



## **GSi NAV** **OTR from £38,220**

*Features over Tech Line Nav:*

### **Exterior convenience / styling:**

- 20-inch five twin-spoke alloy wheels
- GSi front and rear bumpers
- GSi side sills
- GSi rear spoiler (Grand Sport models)
- Visible exhaust tailpipes
- IntelliLux LED® matrix headlights
- FlexRide with Competition mode
- Sports chassis
- Dark-tinted rear windows
- Torque vectoring system

### **Interior convenience / styling:**

- Perforated leather seat facings
- Ergonomic AGR active front seats
- Heated front and outer rear seats
- Heated, flat-bottom, leather-covered steering wheel
- Head-up display
- 8-inch colour information display
- Dark fabric headlining
- Sports pedals
- FlexOrganiser® Pack (Sports Tourer models)

### **Infotainment:**

- Multimedia Navi Pro system
- Fully integrated European sat nav system
- 8-inch colour touchscreen
- Bose® premium sound system



## **COUNTRY TOURER** **OTR from £ 27,150**

*Standard features include:*

### **Exterior convenience / styling:**

- 18-inch bi-colour five twin-spoke alloy wheels
- Anthracite wheel arch and side sill extensions
- Front and rear bumpers incorporating silver-effect skid plates
- Silver-effect roof rails
- Front and rear parking sensors
- FlexRide
- Automatic lighting control
- Electrically operated front / rear windows
- Electrically adjustable / heated door mirrors

### **Interior convenience / styling:**

- Dual-zone electronic climate control
- Leather-covered steering wheel
- Steering wheel audio / phone / cruise controls
- Steering column adjustable for reach / rake

### **Infotainment:**

- Multimedia Navi system
- Fully integrated sat nav system
- 7-inch colour touchscreen
- Bluetooth® / Apple CarPlay™ / Android Auto™
- Seven speakers (five front, two rear)
- Bose® premium sound system (2.0 (210PS) BiTurbo D 4X4 models)

### **Safety / security:**

- Electronic Stability Programme (ESP)
- Anti-lock Braking System (ABS)
- Driving Assistance Pack One
- Six airbags
- Keyless start
- Security alarm system (Thatcham approved, T1)



# INSIGNIA DESIGN



		Grand Sport		Sports Tourer	
		OTR RRP	CO <sub>2</sub> (g/km)	OTR RRP	CO <sub>2</sub> (g/km)
<b>DESIGN – ON-THE-ROAD PRICES</b>					
Petrol	1.5 (140PS) Turbo	£19,940	129	£21,500	131
	1.5 (165PS) Turbo	£20,240	129	£21,800	131
	1.5 (165PS) Turbo auto	£21,880	138	£23,400	144
Diesel	1.6 (110PS) Turbo D BlueInjection ecoTEC	£20,340	116	£21,840	121
	1.6 (136PS) Turbo D BlueInjection	£20,840	121	£22,340	125
	1.6 (136PS) Turbo D auto BlueInjection	£22,750	137	£24,250	139
	2.0 (170PS) Turbo D BlueInjection	–	–	£23,450	145
	2.0 (170PS) Turbo D auto BlueInjection	–	–	£25,050	148

		Grand Sport		Sports Tourer	
		OTR RRP	CO <sub>2</sub> (g/km)	OTR RRP	CO <sub>2</sub> (g/km)
<b>DESIGN NAV – ON-THE-ROAD PRICES</b>					
Petrol	1.5 (140PS) Turbo	£20,740	129	£22,300	131
	1.5 (165PS) Turbo	£21,040	129	£22,600	131
	1.5 (165PS) Turbo auto	£22,680	138	£24,200	144
Diesel	1.6 (110PS) Turbo D BlueInjection ecoTEC	£21,140	116	£22,640	121
	1.6 (136PS) Turbo D BlueInjection	£21,640	121	£23,140	125
	1.6 (136PS) Turbo D auto BlueInjection	£23,550	137	£25,050	139
	2.0 (170PS) Turbo D BlueInjection	–	–	£24,250	145
	2.0 (170PS) Turbo D auto BlueInjection	–	–	£25,850	148

Please note: On-the-road recommended retail prices (RRP) include VAT at 20%, number plates and delivery to Retailer of £700.00 (inc. £116.67 VAT), 12 months' Vehicle Excise Duty and new vehicle first registration fee of £55.00. Excludes fuel and insurance.

KEY OPTIONS		Total inc. VAT
	<b>Looking good:</b>	
	Brilliant paint	£285
	Metallic / pearlescent paint	£605
	Two-coat premium paint	£655
	Tri-coat premium paint	£875
18-inch bi-colour alloy wheels	£505	
	<b>Easier parking:</b>	
Front and rear parking distance sensors	£460	
	<b>Sitting comfortably:</b>	
Ergonomic driver's active seat	£425	
	<b>Fresh air:</b>	
Dual-zone electronic climate control	£405	
	<b>Driving assistance:</b>	
<b>Driving Assistance Pack Four</b>		
Front and rear parking distance sensors / lane change assist with side blind spot alert / rear-view camera / rear cross traffic alert	£650	
	<b>Practicality:</b>	
17-inch steel emergency spare wheel (in lieu of emergency tyre inflation kit)	£110	
<b>Sight and Light Pack</b>		
Automatic lighting control with tunnel detection / rain-sensitive windscreen wipers / auto-dimming rear-view mirror / high beam assist	£240	

For details of these and other options please see Features / Options pages.

## FEATURES

### Infotainment:

- Multimedia audio system
  - 7-inch colour touchscreen
  - AM/FM/DAB digital radio
  - Bluetooth® audio streaming
  - Bluetooth® mobile phone portal
  - Apple CarPlay™ / Android Auto™
  - USB audio connection
- Seven speakers (five front, two rear)

### Interior convenience / styling:

- Air conditioning
- Multi-function trip computer
- Cruise control with speed limiter
- Leather-covered steering wheel
- Front centre armrest
- Steering wheel audio / phone / cruise controls
- Steering column adjustable for reach / rake

### Exterior convenience / styling:

- 17-inch bi-colour structure wheels (1.6 diesel ecoTEC models)
- 17-inch five twin-spoke alloy wheels (excluding 1.6 diesel ecoTEC models)
- Automatic lighting control
- Electrically operated front / rear windows
- Electrically adjustable / heated door mirrors
- Black roof rails (Sports Tourer models)

### Safety / security:

- Driving Assistance Pack One
  - Front camera system
  - Forward collision alert with automatic city emergency braking
  - Following distance indicator
  - Lane departure warning with lane assist
- Electronic Stability Programme (ESP)
- Anti-lock Braking System (ABS)
- Six airbags
- Hill start assist
- ISOFIX child seat mounting points, outer rear seats
- Tyre pressure monitoring system
- LED daytime running lights
- Keyless start
- Remote control central locking
- Security alarm system (Thatcham approved, T1)

### Design Nav models additionally feature:

- Multimedia Navi system
  - Fully integrated sat nav system
  - 7-inch colour touchscreen
- Traffic sign recognition

## COMPANY CAR INFORMATION

- P11D price starting at £19,720
- From 26% tax band\*
- From £86 monthly BiK tax\*
- CO<sub>2</sub> emissions from 116g/km

Please see [www.vauxhall.co.uk/fleet](http://www.vauxhall.co.uk/fleet) for details.

\* = 2018/19 tax year.

# INSIGNIA SRI



		Grand Sport		Sports Tourer	
		OTR RRP	CO <sub>2</sub> (g/km)	OTR RRP	CO <sub>2</sub> (g/km)
<b>SRI – ON-THE-ROAD PRICES</b>					
Petrol	1.5 (165PS) Turbo	£22,710	129	£24,270	131
	1.5 (165PS) Turbo auto	£24,350	138	£25,870	144
Diesel	1.6 (110PS) Turbo D BlueInjection ecoTEC	£22,810	116	£24,310	121
	1.6 (136PS) Turbo D BlueInjection	£23,310	121	£24,810	125
	1.6 (136PS) Turbo D auto BlueInjection	£25,220	137	£26,720	139
	2.0 (170PS) Turbo D BlueInjection	£24,420	141	£25,920	145
	2.0 (170PS) Turbo D auto BlueInjection	£26,020	146	£27,520	148

		Grand Sport		Sports Tourer	
		OTR RRP	CO <sub>2</sub> (g/km)	OTR RRP	CO <sub>2</sub> (g/km)
<b>SRI NAV – ON-THE-ROAD PRICES</b>					
Petrol	1.5 (165PS) Turbo	£23,500	129	£25,060	131
	1.5 (165PS) Turbo auto	£25,140	138	£26,660	144
Diesel	1.6 (110PS) Turbo D BlueInjection ecoTEC	£23,600	116	£25,100	121
	1.6 (136PS) Turbo D BlueInjection	£24,100	121	£25,600	125
	1.6 (136PS) Turbo D auto BlueInjection	£26,010	137	£27,510	139
	2.0 (170PS) Turbo D BlueInjection	£25,210	141	£26,710	145
	2.0 (170PS) Turbo D auto BlueInjection	£26,810	146	£28,310	148

Please note: On-the-road recommended retail prices (RRP) include VAT at 20%, number plates and delivery to Retailer of £700.00 (inc. £116.67 VAT), 12 months' Vehicle Excise Duty and new vehicle first registration fee of £55.00. Excludes fuel and insurance.

KEY OPTIONS		Total inc. VAT
<b>Looking good:</b>	Brilliant paint	£285
	Metallic / pearlescent paint	£605
	Two-coat premium paint	£655
	Tri-coat premium paint	£875
	18-inch bi-colour alloy wheels	£505
	20-inch five twin-spoke alloy wheels	£995
	<b>VX-Line Styling Pack</b> <i>Sports-style bumpers / side sills / visible exhaust tailpipe (body style / engine dependent)</i>	£850
<b>Sitting comfortably:</b>	Leather-covered ergonomic active front seats	£1155
	<b>Winter Pack One</b> <i>Heated front seats / heated steering wheel / heated windscreen</i>	£660
<b>Driving assistance:</b>	<b>Driving Assistance Pack Four</b> <i>Lane change assist with side blind spot alert / rear-view camera / rear cross traffic alert</i>	£650
	IntelliLux LED® matrix headlights	£1295
<b>Practicality:</b>	17-inch steel emergency spare wheel (in lieu of tyre inflation kit)	£110

For details of these and other options please see Features / Options pages.

## FEATURES

### Infotainment:

- Multimedia audio system
  - 7-inch colour touchscreen
  - AM/FM/DAB digital radio
  - Bluetooth® audio streaming
  - Bluetooth® mobile phone portal
  - Apple CarPlay™ / Android Auto™
  - USB audio connection
- Seven speakers (five front, two rear)

### Interior convenience / styling:

- AGR active front seats
- Dual-zone electronic climate control
- Multi-function trip computer
- Cruise control with speed limiter
- Leather-covered steering wheel
- Front centre armrest
- Steering wheel audio / phone / cruise controls
- Steering column adjustable for reach / rake
- Sports pedals
- Twin rear USB sockets
- Auto-dimming rear-view mirror
- Illuminated vanity mirrors
- Storage pockets on front seat backs
- Ambient LED lighting in front doors

### Exterior convenience / styling:

- 17-inch five twin-spoke alloy wheels
- Front fog lights
- Automatic lighting control with tunnel detection
- Rain-sensitive windscreen wipers
- Electrically adjustable / heated door mirrors
- Rear spoiler (Grand Sport models)
- Front and rear parking sensors
- Silver-effect roof rails (Sports Tourer models)

### Safety / security:

- Driving Assistance Pack One
  - Front camera system
  - Forward collision alert with automatic city emergency braking
  - Following distance indicator
  - Lane departure warning with lane assist
- Electronic Stability Programme (ESP)
- Anti-lock Braking System (ABS)
- Six airbags
- ISOFIX child seat mounting points, outer rear seats
- Tyre pressure monitoring system
- LED daytime running lights
- Security alarm system (Thatcham approved, T1)

### SRI Nav models additionally feature:

- Multimedia Navi system
  - Fully integrated sat nav system
  - 7-inch colour touchscreen
- Traffic sign recognition

## COMPANY CAR INFORMATION

- P11D price starting at £22,490
- From 26% tax band\*
- From £98 monthly BiK tax\*
- CO<sub>2</sub> emissions from 116g/km





Please see [www.vauxhall.co.uk/fleet](http://www.vauxhall.co.uk/fleet) for details.

\* = 2018/19 tax year.

# INSIGNIA SRi VX-LINE NAV

		Grand Sport		Sports Tourer	
		OTR RRP	CO <sub>2</sub> (g/km)	OTR RRP	CO <sub>2</sub> (g/km)
<b>SRi VX-LINE NAV – ON-THE-ROAD PRICES</b>					
<i>Petrol</i>	1.5 (165PS) Turbo	£24,720	129	£26,280	131
	1.5 (165PS) Turbo auto	£26,360	138	£27,880	144
	1.6 (200PS) Turbo	£26,260	145	£28,090	151
	1.6 (200PS) Turbo auto	£29,620	153	£31,140	154
<i>Diesel</i>	1.6 (136PS) Turbo D BlueInjection	£25,320	121	£26,820	125
	1.6 (136PS) Turbo D auto BlueInjection	£27,230	137	£28,730	139
	2.0 (170PS) Turbo D BlueInjection	£26,430	141	£27,930	145
	2.0 (170PS) Turbo D auto BlueInjection	£28,030	146	£29,530	148

Please note: On-the-road recommended retail prices (RRP) include VAT at 20%, number plates and delivery to Retailer of £700.00 (inc. £116.67 VAT), 12 months' Vehicle Excise Duty and new vehicle first registration fee of £55.00. Excludes fuel and insurance.

KEY OPTIONS		Total inc. VAT
 <b>Looking good:</b>	Brilliant paint	£285
	Metallic / pearlescent paint	£605
	Two-coat premium paint	£655
	Tri-coat premium paint	£875
	20-inch five twin-spoke alloy wheels	£880
 <b>Sitting comfortably:</b>	Leather-covered ergonomic active front seats	£1155
	<b>Winter Pack Four</b> <i>Heated front seats / heated windscreen</i>	£410
 <b>Driving assistance:</b>	<b>Driving Assistance Pack Four</b> <i>Lane change assist with side blind spot alert / rear-view camera / rear cross traffic alert</i>	£650
	Head-up display	£290
	IntelliLux LED® matrix headlights	£1295
 <b>Practicality:</b>	17-inch steel emergency spare wheel (in lieu of emergency tyre inflation kit)	£110
	Wireless charger for mobile devices	£160
	FlexOrganiser® Pack (Sports Tourer models)	£120
	Power tailgate (Sports Tourer models)	£680
 <b>Infotainment:</b>	<b>Multimedia Navi Pro system</b> – Fully integrated European sat nav system	£1160
	– 8-inch colour touchscreen	

For details of these and other options please see Features / Options pages.



## FEATURES

### Infotainment:

- Multimedia Navi system
  - Fully integrated sat nav system
  - 7-inch colour touchscreen
  - AM/FM/DAB digital radio
  - Bluetooth® audio streaming
  - Bluetooth® mobile phone portal
  - Apple CarPlay™ / Android Auto™
  - USB audio connection
- Seven speakers (five front, two rear)

### Interior convenience / styling:

- AGR active front seats
- Dual-zone electronic climate control
- Multi-function trip computer
- Cruise control with speed limiter
- Steering wheel audio / phone / cruise controls
- Heated, flat bottom, leather-covered VX-Line steering wheel
- Steering column adjustable for reach / rake
- Sports pedals
- Dark fabric headlining
- Twin rear USB sockets
- Auto-dimming rear-view mirror

### Exterior convenience / styling:





- 17-inch alloy wheels (1.6 diesel manual models)
- 18-inch alloy wheels (excluding 1.6 diesel manual and 1.6 (200PS) Turbo models)
- 20-inch five twin-spoke alloy wheels (1.6 (200PS) Turbo models)
- VX-Line Styling Pack
  - Sports-style front and rear bumpers
  - Side sills
  - Rear spoiler (Grand Sport models)
  - Dual visible exhaust tailpipes (Grand Sport 1.6 (200PS) Turbo and 2.0 (210PS) BiTurbo D models). Dual imitation exhaust bezels (Sports Tourer 1.6 (200PS) Turbo and 2.0 (210PS) BiTurbo D models (not available on 1.5 (165PS) Petrol, 1.6 (110/136PS) and 2.0 (170PS) Diesel models)

- Chrome-effect upper window trim
- Automatic lighting control with tunnel detection
- Electrically operated front / rear windows
- Electrically adjustable / heated door mirrors
- Front and rear parking sensors
- Silver-effect roof rails (Sports Tourer models)

### Safety / security:

- Driving Assistance Pack One
  - Front camera system
  - Forward collision alert with automatic city emergency braking
  - Following distance indicator
  - Lane departure warning with lane assist
  - Traffic sign recognition
- Electronic Stability Programme (ESP)
- Anti-lock Braking System (ABS)
- Six airbags
- ISOFIX child seat mounting points, outer rear seats
- Tyre pressure monitoring system
- LED daytime running lights
- Remote control central locking
- Security alarm system (Thatcham approved, T1)

## COMPANY CAR INFORMATION

-  **P11D price starting at £24,500**
-  **From 26% tax band\***
-  **From £107 monthly BiK tax\***
-  **CO<sub>2</sub> emissions from 121g/km**





Please see [www.vauxhall.co.uk/fleet](http://www.vauxhall.co.uk/fleet) for details.

\* = 2018/19 tax year.

# INSIGNIA TECH LINE NAV

		Grand Sport		Sports Tourer	
		OTR RRP	CO <sub>2</sub> (g/km)	OTR RRP	CO <sub>2</sub> (g/km)
<b>TECH LINE NAV – ON-THE-ROAD PRICES</b>					
Petrol	1.5 (165PS) Turbo	£23,300	129	£24,860	131
	1.5 (165PS) Turbo auto	£24,940	138	£26,460	144
Diesel	1.6 (110PS) Turbo D BlueInjection ecoTEC	£23,400	116	£24,900	121
	1.6 (136PS) Turbo D BlueInjection	£23,900	121	£25,400	125
	1.6 (136PS) Turbo D auto BlueInjection	£25,810	137	£27,310	139
	2.0 (170PS) Turbo D BlueInjection	£25,010	141	£26,510	145
	2.0 (170PS) Turbo D auto BlueInjection	£26,610	146	£28,110	148

Please note: On-the-road recommended retail prices (RRP) include VAT at 20%, number plates and delivery to Retailer of £700.00 (inc. £116.67 VAT), 12 months' Vehicle Excise Duty and new vehicle first registration fee of £55.00. Excludes fuel and insurance.

KEY OPTIONS		Total inc. VAT
 <b>Looking good:</b>	Brilliant paint	£285
	Metallic / pearlescent paint	£605
	Two-coat premium paint	£655
	Tri-coat premium paint	£875
	18-inch bi-colour alloy wheels	£505
	20-inch five twin-spoke alloy wheels	£995
 <b>Sitting comfortably:</b>	Leather-covered ergonomic active front seats	£1155
	<b>Winter Pack One</b> <i>Heated front seats / heated steering wheel / heated windscreen</i>	£660
 <b>Driving assistance:</b>	<b>Driving Assistance Pack Two</b> <i>Automatic cruise control / automatic brake intervention</i>	£570
	<b>Driving Assistance Pack Four</b> <i>Lane change assist with side blind spot alert / rear-view camera / rear cross traffic alert</i>	£650
	Head-up display	£290
	IntelliLux LED® matrix headlights	£1295
	<b>Practicality:</b>	17-inch steel emergency spare wheel (in lieu of emergency tyre inflation kit)
	Wireless charger for mobile devices	£160
	FlexOrganiser® Pack (Sports Tourer models)	£120
	Power tailgate (Sports Tourer models)	£680
	Towing Pack	£685
 <b>Infotainment:</b>	<b>Multimedia Navi Pro system</b> – Fully integrated European sat nav system	£1160
	– 8-inch colour touchscreen	

For details of these and other options please see Features / Options pages.



## FEATURES

### Infotainment:

- Multimedia Navi system
  - Fully integrated sat nav system
  - 7-inch colour touchscreen
  - AM/FM/DAB digital radio
  - Bluetooth® audio streaming
  - Bluetooth® mobile phone portal
  - Apple CarPlay™ / Android Auto™
  - USB audio connection
- Seven speakers (five front, two rear)

### Interior convenience / styling:

- Dual-zone electronic climate control
- Multi-function trip computer
- 16-way adjustable driver's seat
- Front centre armrest
- Storage pockets on front seat backs
- Cruise control with speed limiter
- Leather-covered steering wheel
- Steering wheel audio / phone / cruise controls
- Steering column adjustable for reach / rake
- Twin rear USB sockets
- Auto-dimming rear-view mirror





### Exterior convenience / styling:

- 17-inch five twin-spoke alloy wheels
- Chrome-effect upper window trim
- Rain-sensitive windscreen wipers
- Automatic lighting control with tunnel detection
- Electrically adjustable/heated door mirrors
- Front and rear parking sensors
- Silver-effect roof rails (Sports Tourer models)

### Safety / security:

- Driving Assistance Pack One
  - Front camera system
  - Forward collision alert with automatic city emergency braking
  - Following distance indicator
  - Lane departure warning with lane assist
  - Traffic sign recognition
- Electronic Stability Programme (ESP)
- Anti-lock Braking System (ABS)
- Six airbags
- Hill start assist
- ISOFIX child seat mounting points, outer rear seats
- Tyre pressure monitoring system
- LED daytime running lights
- Security alarm system (Thatcham approved, T1)
- Electronic engine deadlock immobiliser

## COMPANY CAR INFORMATION

-  P11D price starting at £23,080
-  From 26% tax band\*
-  From £100 monthly BiK tax\*
-  CO<sub>2</sub> emissions from 116g/km

Please see [www.vauxhall.co.uk/fleet](http://www.vauxhall.co.uk/fleet) for details.





\* = 2018/19 tax year.



# INSIGNIA ELITE NAV

		Grand Sport		Sports Tourer	
		OTR RRP	CO <sub>2</sub> (g/km)	OTR RRP	CO <sub>2</sub> (g/km)
<b>ELITE NAV – ON-THE-ROAD PRICES</b>					
<i>Petrol</i>	1.5 (165PS) Turbo	<b>£26,530</b>	129	<b>£28,090</b>	131
	1.5 (165PS) Turbo auto	<b>£28,170</b>	138	<b>£29,690</b>	144
	1.6 (200PS) Turbo	<b>£28,070</b>	145	<b>£29,900</b>	151
	1.6 (200PS) Turbo auto	<b>£30,830</b>	153	<b>£32,350</b>	154
<i>Diesel</i>	1.6 (110PS) Turbo D BlueInjection ecoTEC	<b>£26,630</b>	116	<b>£28,130</b>	121
	1.6 (136PS) Turbo D BlueInjection	<b>£27,130</b>	121	<b>£28,630</b>	125
	1.6 (136PS) Turbo D auto BlueInjection	<b>£29,040</b>	137	<b>£30,540</b>	139
	2.0 (170PS) Turbo D BlueInjection	<b>£28,240</b>	141	<b>£29,740</b>	145
	2.0 (170PS) Turbo D auto BlueInjection Euro	<b>£29,840</b>	146	<b>£31,340</b>	148
	2.0 (210PS) BiTurbo D 4X4 auto BlueInjection	<b>£31,160</b>	184	<b>£32,660</b>	187

Please note: On-the-road recommended retail prices (RRP) include VAT at 20%, number plates and delivery to Retailer of £700.00 (inc. £116.67 VAT), 12 months' Vehicle Excise Duty and new vehicle first registration fee of £55.00. Excludes fuel and insurance.

<b>KEY OPTIONS</b>		<b>Total inc. VAT</b>
 <b>Looking good:</b>	Brilliant paint	<b>£285</b>
	Metallic / pearlescent paint	<b>£605</b>
	Two-coat premium paint	<b>£655</b>
	Tri-coat premium paint	<b>£875</b>
	20-inch five twin-spoke alloy wheels	<b>£880</b>
 <b>Sitting comfortably:</b>	<b>Winter Pack Two</b>	<b>£400</b>
	<i>Heated steering wheel / heated windscreen</i>	
 <b>Driving assistance:</b>	<b>Driving Assistance Pack Two</b>	<b>£570</b>
	<i>Automatic cruise control / automatic brake intervention</i>	
	<b>Driving Assistance Pack Four</b>	<b>£650</b>
	<i>Lane change assist with side blind spot alert / rear-view camera / rear cross traffic alert</i>	
 <b>Practicality:</b>	17-inch steel emergency spare wheel (in lieu of emergency tyre inflation kit)	<b>£110</b>
	Wireless charger for mobile devices	<b>£160</b>
	FlexOrganiser® Pack (Sports Tourer models)	<b>£120</b>
	Power tailgate (Sports Tourer models)	<b>£680</b>
	Towing Pack	<b>£685</b>

For details of these and other options please see Features / Options pages.



## FEATURES

### Infotainment:

- Multimedia Navi Pro system
  - Fully integrated European sat nav system
  - 8-inch colour touchscreen
  - AM/FM/DAB digital radio
  - Bluetooth® audio streaming
  - Bluetooth® mobile phone portal
  - Apple CarPlay™ / Android Auto™
  - USB audio connection
- Seven speakers (five front, two rear)
- Bose® premium sound system (2.0 (210PS) BiTurbo D 4X4 models only)

### Interior convenience / styling:

- Leather seat facings
- Dual-zone electronic climate control
- Leather-covered steering wheel
- Heated front seats
- 16-way adjustable driver's seat
- Multi-function trip computer
- Cruise control with speed limiter
- Front centre armrest
- Steering wheel audio / phone / cruise controls
- 8-inch colour information display
- Twin rear USB sockets

### Exterior convenience / styling:

- 17-inch alloy wheels (1.6 diesel manual models)
- 18-inch alloy wheels (excluding 1.6 diesel manual, 1.6 (200PS) Turbo and 2.0 (210PS) BiTurbo D 4X4 models)
- 20-inch alloy wheels (1.6 (200PS) Turbo and 2.0 (210PS) BiTurbo D 4X4 models)
- IntelliLux LED® matrix headlights
- Rain-sensitive windscreen wipers
- Automatic lighting control with tunnel detection
- Front fog lights
- Dark-tinted rear windows
- Front and rear parking sensors
- Silver-effect roof rails (Sports Tourer models)

### Safety / security:

- Driving Assistance Pack One
  - Front camera system
  - Forward collision alert with automatic city emergency braking
  - Following distance indicator
  - Lane departure warning with lane assist
  - Traffic sign recognition
- Electronic Stability Programme (ESP)
- Anti-lock Braking System (ABS)
- Six airbags
- Hill start assist
- ISOFIX child seat mounting points, outer rear seats
- Tyre pressure monitoring system
- Security alarm system (Thatcham approved, T1)

## COMPANY CAR INFORMATION

-  **P11D price starting at £26,310**
-  **From 26% tax band\***
-  **From £114 monthly BiK tax\***
-  **CO<sub>2</sub> emissions from 116g/km**

Please see [www.vauxhall.co.uk/fleet](http://www.vauxhall.co.uk/fleet) for details.

\* = 2018/19 tax year.





# INSIGNIA GSi NAV

	Grand Sport		Sports Tourer	
	OTR RRP	CO <sub>2</sub> (g/km)	OTR RRP	CO <sub>2</sub> (g/km)

## GSi NAV – ON-THE-ROAD PRICES

Diesel 2.0 (210PS) BiTurbo D 4X4 auto BlueInjection	£38,220	187	£39,720	188
---	---------	-----	---------	-----

Please note: On-the-road recommended retail prices (RRP) include VAT at 20%, number plates and delivery to Retailer of £700.00 (inc. £116.67 VAT), 12 months' Vehicle Excise Duty and new vehicle first registration fee of £55.00. Excludes fuel and insurance.

KEY OPTIONS		Total inc. VAT
	<b>Looking good:</b> Lava Red brilliant paint	£285
	Metallic / pearlescent paint	£605
	Tri-coat premium paint	£875
	<b>Sitting comfortably:</b> Winter Pack Three Heated windscreen	£150
	<b>Driving assistance:</b> Driving Assistance Pack Two Automatic cruise control / automatic brake intervention	£570
	<b>Practicality:</b> Wireless charger for mobile devices	£160

For details of these and other options please see Features / Options pages.



## FEATURES

### Infotainment:

- Multimedia Navi Pro system
  - Fully integrated European sat nav system
  - 8-inch colour touchscreen
  - AM/FM/DAB digital radio
  - Bluetooth® audio streaming
  - Bluetooth® mobile phone portal
  - Apple CarPlay™ / Android Auto™
  - USB audio connection
- Bose® premium sound system

### Interior convenience / styling:

- Perforated leather seat facings
- Ergonomic AGR active front seats
- Dual-zone electronic climate control
- Heated, flat-bottom leather-covered VX-Line steering wheel
- Heated front and outer rear seats
- Multi-function trip computer
- Cruise control with speed limiter
- Front centre armrest
- Steering wheel audio / phone / cruise controls
- Head-up display
- 8-inch colour information display
- Twin rear USB sockets
- FlexOrganiser® Pack (Sports Tourer models)





### Exterior convenience / styling:

- 20-inch alloy wheels
- GSi front and rear bumpers
- GSi side sills
- GSi rear spoiler (Grand Sport models)
- Visible exhaust tailpipes
- IntelliLux LED® matrix headlights
- FlexRide with Competition mode
- Sports chassis
- Rain-sensitive windscreen wipers
- Automatic lighting control with tunnel detection
- Dark-tinted rear windows
- Front and rear parking sensors
- Silver-effect roof rails (Sports Tourer models)

### Safety / security:

- Driving Assistance Pack One
  - Front camera system
  - Forward collision alert with automatic city emergency braking
  - Following distance indicator
  - Lane departure warning with lane assist
  - Traffic sign recognition
- Electronic Stability Programme (ESP)
- Anti-lock Braking System (ABS)
- Six airbags
- Hill start assist
- Tyre pressure monitoring system
- Keyless entry and start
- Security alarm system (Thatcham approved, T1)

## COMPANY CAR INFORMATION

-  P11D price starting at £36,925
-  From 37% tax band\*
-  From £228 monthly BiK tax\*
-  CO<sub>2</sub> emissions from 187g/km

Please see [www.vauxhall.co.uk/fleet](http://www.vauxhall.co.uk/fleet) for details.

\* = 2018/19 tax year.





# INSIGNIA COUNTRY TOURER

Country Tourer  
OTR RRP CO<sub>2</sub> (g/km)

## COUNTRY TOURER – ON-THE-ROAD PRICES

Diesel	2.0 (170PS) Turbo D BlueInjection	£27,150	150
	2.0 (170PS) Turbo D auto BlueInjection	£29,070	151
	2.0 (170PS) Turbo D 4X4 BlueInjection	£28,470	164
	2.0 (210PS) BiTurbo D 4X4 auto BlueInjection	£30,080	188

Please note: On-the-road recommended retail prices (RRP) include VAT at 20%, number plates and delivery to Retailer of £700.00 (inc. £116.67 VAT), 12 months' Vehicle Excise Duty and new vehicle first registration fee of £55.00. Excludes fuel and insurance.

KEY OPTIONS	Total inc. VAT	
 <b>Looking good:</b>	Brilliant paint	£285
	Metallic / pearlescent paint	£605
	Two-coat premium paint	£655
	Tri-coat premium paint	£875
 <b>Sitting comfortably:</b>	Leather-covered ergonomic active front seats	£1155
	<b>Winter Pack One</b> <i>Heated front seats / heated steering wheel / heated windscreen</i>	£660
 <b>Driving assistance:</b>	<b>Driving Assistance Pack Two</b> <i>Automatic cruise control / automatic brake intervention</i>	£570
	<b>Driving Assistance Pack Four</b> <i>Advanced park assist / lane change assist with side blind spot alert / rear-view camera / rear cross traffic alert</i>	£650
	Head-up display	£290
	IntelliLux LED® matrix headlights	£1295
 <b>Practicality:</b>	17-inch steel emergency spare wheel (in lieu of emergency tyre inflation kit)	£110
	Wireless charger for mobile devices	£160
	FlexOrganiser® Pack	£120
	Power tailgate	£680
	Towing Pack	£685

For details of these and other options please see Features / Options pages.



## FEATURES

### Infotainment:

- Multimedia Navi system
  - 7-inch colour touchscreen
  - AM/FM/DAB digital radio
  - Bluetooth® audio streaming
  - Bluetooth® mobile phone portal
  - Apple CarPlay™ / Android Auto™
  - USB audio connection
- Seven speakers (five front, two rear)
- Bose® premium sound system (2.0 (210PS) BiTurbo D 4X4 models)

### Interior convenience / styling:

- Dual-zone electronic climate control
- Leather-covered steering wheel
- 16-way adjustable driver's seat
- Multi-function trip computer
- Cruise control with speed limiter
- Front centre armrest
- Steering wheel audio / phone / cruise controls
- Twin rear USB sockets

### Exterior convenience / styling:

- 18-inch alloy wheels
- Anthracite wheel arch and side sill extensions
- Front and rear bumpers incorporating silver-effect skid plates
- FlexRide
- Rain-sensitive windscreen wipers
- Automatic lighting control with tunnel detection
- Front fog lights
- Dark-tinted rear windows
- Electrically adjustable / heated door mirrors
- Front and rear parking sensors
- Silver-effect roof rails

### Safety / security:

- Driving Assistance Pack One
  - Front camera system
  - Forward collision alert with automatic city emergency braking
  - Following distance indicator
  - Lane departure warning with lane assist
  - Traffic sign recognition
- Electronic Stability Programme (ESP)
- Anti-lock Braking System (ABS)
- Six airbags
- Hill start assist
- ISOFIX child seat mounting points, outer rear seats
- Tyre pressure monitoring system
- Security alarm system (Thatcham approved, T1)

## COMPANY CAR INFORMATION

- ✓ P11D price starting at £26,580
- ✓ From 35% tax band\*
- ✓ From £156 monthly BiK tax\*
- ✓ CO<sub>2</sub> emissions from 150g/km

Please see [www.vauxhall.co.uk/fleet](http://www.vauxhall.co.uk/fleet) for details.

\* = 2018/19 tax year.

# INSIGNIA PRICES

Model	Price (£)	VAT (£)	Total (£)	On-the-road RRP (£)	CO <sub>2</sub> (g/km)	Model	Price (£)	VAT (£)	Total (£)	On-the-road RRP (£)	CO <sub>2</sub> (g/km)
<b>Grand Sport</b>						<b>Grand Sport</b>					
<b>DESIGN</b>						<b>SRI VX-LINE NAV</b>					
1.5 (140PS) Turbo	15850.00	3170.00	19020.00	<b>19940.00</b>	129	1.5 (165PS) Turbo	19833.33	3966.67	23800.00	<b>24720.00</b>	129
1.5 (165PS) Turbo	16100.00	3220.00	19320.00	<b>20240.00</b>	129	1.5 (165PS) Turbo auto	21166.66	4233.34	25400.00	<b>26360.00</b>	138
1.5 (165PS) Turbo auto	17433.32	3486.68	20920.00	<b>21880.00</b>	138	1.6 (200PS) Turbo	21083.33	4216.67	25300.00	<b>26260.00</b>	145
<i>Diesel</i>						1.6 (200PS) Turbo auto	23625.00	4725.00	28350.00	<b>29620.00</b>	153
1.6 (110PS) Turbo D BlueInjection* ecoTEC	16150.00	3230.00	19380.00	<b>20340.00</b>	116	<i>Diesel</i>					
1.6 (136PS) Turbo D BlueInjection*	16566.67	3313.33	19880.00	<b>20840.00</b>	121	1.6 (136PS) Turbo D BlueInjection*	20300.00	4060.00	24360.00	<b>25320.00</b>	121
1.6 (136PS) Turbo D auto BlueInjection*	17900.00	3580.00	21480.00	<b>22750.00</b>	137	1.6 (136PS) Turbo D auto BlueInjection*	21633.33	4326.67	25960.00	<b>27230.00</b>	137
<b>DESIGN NAV</b>						<b>TECH LINE NAV</b>					
1.5 (140PS) Turbo	16516.66	3303.34	19820.00	<b>20740.00</b>	129	1.5 (165PS) Turbo	18650.00	3730.00	22380.00	<b>23300.00</b>	129
1.5 (165PS) Turbo	16766.66	3353.34	20120.00	<b>21040.00</b>	129	1.5 (165PS) Turbo auto	19983.33	3996.67	23980.00	<b>24940.00</b>	138
1.5 (165PS) Turbo auto	18100.00	3620.00	21720.00	<b>22680.00</b>	138	<i>Diesel</i>					
<i>Diesel</i>						1.6 (110PS) Turbo D BlueInjection* ecoTEC	18700.00	3740.00	22440.00	<b>23400.00</b>	116
1.6 (110PS) Turbo D BlueInjection* ecoTEC	16816.66	3363.34	20180.00	<b>21140.00</b>	116	1.6 (136PS) Turbo D BlueInjection*	19116.66	3823.34	22940.00	<b>23900.00</b>	121
1.6 (136PS) Turbo D BlueInjection*	17233.33	3446.67	20680.00	<b>21640.00</b>	121	1.6 (136PS) Turbo D auto BlueInjection*	20450.00	4090.00	24540.00	<b>25810.00</b>	137
1.6 (136PS) Turbo D auto BlueInjection*	18566.66	3713.34	22280.00	<b>23550.00</b>	137	2.0 (170PS) Turbo D BlueInjection*	19783.33	3956.67	23740.00	<b>25010.00</b>	141
<b>SRI</b>						<b>ELITE NAV</b>					
1.5 (165PS) Turbo	18158.33	3631.67	21790.00	<b>22710.00</b>	129	1.5 (165PS) Turbo	21341.66	4268.34	25610.00	<b>26530.00</b>	129
1.5 (165PS) Turbo auto	19491.66	3898.34	23390.00	<b>24350.00</b>	138	1.5 (165PS) Turbo auto	22675.00	4535.00	27210.00	<b>28170.00</b>	138
<i>Diesel</i>						1.6 (200PS) Turbo	22591.67	4518.33	27110.00	<b>28070.00</b>	145
1.6 (110PS) Turbo D BlueInjection* ecoTEC	18208.33	3641.67	21850.00	<b>22810.00</b>	116	1.6 (200PS) Turbo auto	24633.33	4926.67	29560.00	<b>30830.00</b>	153
1.6 (136PS) Turbo D BlueInjection*	18625.00	3725.00	22350.00	<b>23310.00</b>	121	<i>Diesel</i>					
1.6 (136PS) Turbo D auto BlueInjection*	19958.33	3991.67	23950.00	<b>25220.00</b>	137	1.6 (110PS) Turbo D BlueInjection* ecoTEC	21391.66	4278.34	25670.00	<b>26630.00</b>	116
2.0 (170PS) Turbo D BlueInjection*	19291.66	3858.34	23150.00	<b>24420.00</b>	141	1.6 (136PS) Turbo D BlueInjection*	21808.33	4361.67	26170.00	<b>27130.00</b>	121
2.0 (170PS) Turbo D auto BlueInjection*	20625.00	4125.00	24750.00	<b>26020.00</b>	146	1.6 (136PS) Turbo D auto BlueInjection*	23141.66	4628.34	27770.00	<b>29040.00</b>	137
<b>SRI NAV</b>						<b>GSI NAV</b>					
1.5 (165PS) Turbo	18816.66	3763.34	22580.00	<b>23500.00</b>	129	2.0 (170PS) Turbo D BlueInjection*	22475.00	4495.00	26970.00	<b>28240.00</b>	141
1.5 (165PS) Turbo auto	20150.00	4030.00	24180.00	<b>25140.00</b>	138	2.0 (170PS) Turbo D auto BlueInjection*	23808.33	4761.67	28570.00	<b>29840.00</b>	146
<i>Diesel</i>						2.0 (210PS) BiTurbo D 4X4 auto BlueInjection*	24304.16	4860.84	29165.00	<b>31160.00</b>	184
1.6 (110PS) Turbo D BlueInjection* ecoTEC	18866.66	3773.34	22640.00	<b>23600.00</b>	116	<b>Please note:</b> On-the-road recommended retail prices (RRP) include number plates and delivery to Retailer of £700.00 (inc. £116.67 VAT) 12 months' Vehicle Excise Duty and new vehicle first registration fee of £55.00. Excludes fuel and insurance.					
1.6 (136PS) Turbo D BlueInjection*	19283.33	3856.67	23140.00	<b>24100.00</b>	121	* = Please note: Vehicles with BlueInjection technology will need regular AdBlue® top-ups also between servicing requirements.					
1.6 (136PS) Turbo D auto BlueInjection*	20616.66	4123.34	24740.00	<b>26010.00</b>	137	An indicator integrated into the on-board computer will warn you when you need to top up. More information under <a href="http://www.vauxhall.co.uk/discover-vauxhall/technology/adblue.html">www.vauxhall.co.uk/discover-vauxhall/technology/adblue.html</a>					
2.0 (170PS) Turbo D BlueInjection*	19950.00	3990.00	23940.00	<b>25210.00</b>	141	In accordance with regulations R (EC) No. 715/2007 and R (EC) No. 692/2008 (in the versions respectively applicable).					
2.0 (170PS) Turbo D auto BlueInjection*	21283.33	4256.67	25540.00	<b>26810.00</b>	146						

# INSIGNIA PRICES

Model	Price (£)	VAT (£)	Total (£)	On-the-road RRP (£)	CO <sub>2</sub> (g/km)	Model	Price (£)	VAT (£)	Total (£)	On-the-road RRP (£)	CO <sub>2</sub> (g/km)
<b>Sports Tourer</b>						<b>Sports Tourer</b>					
<b>DESIGN</b>						<b>SRI VX-LINE NAV</b>					
1.5 (140PS) Turbo	17116.66	3423.34	20540.00	<b>21500.00</b>	131	1.5 (165PS) Turbo	21100.00	4220.00	25320.00	<b>26280.00</b>	131
1.5 (165PS) Turbo	17366.66	3473.34	20840.00	<b>21800.00</b>	131	1.5 (165PS) Turbo auto	22433.33	4486.67	26920.00	<b>27880.00</b>	144
1.5 (165PS) Turbo auto	18700.00	3740.00	22440.00	<b>23400.00</b>	144	1.6 (200PS) Turbo	22350.00	4470.00	26820.00	<b>28090.00</b>	151
<i>Diesel</i>						1.6 (200PS) Turbo auto	24891.67	4978.33	29870.00	<b>31140.00</b>	154
1.6 (110PS) Turbo D BlueInjection* ecoTEC	17400.00	3480.00	20880.00	<b>21840.00</b>	121	<i>Diesel</i>					
1.6 (136PS) Turbo D BlueInjection*	17816.66	3563.34	21380.00	<b>22340.00</b>	125	1.6 (136PS) Turbo D BlueInjection*	21550.00	4310.00	25860.00	<b>26820.00</b>	125
1.6 (136PS) Turbo D auto BlueInjection*	19150.00	3830.00	22980.00	<b>24250.00</b>	139	1.6 (136PS) Turbo D auto BlueInjection*	22883.33	4576.67	27460.00	<b>28730.00</b>	139
2.0 (170PS) Turbo D BlueInjection*	18483.33	3696.67	22180.00	<b>23450.00</b>	145	2.0 (170PS) Turbo D BlueInjection*	22216.66	4443.34	26660.00	<b>27930.00</b>	145
2.0 (170PS) Turbo D auto BlueInjection*	19816.66	3963.34	23780.00	<b>25050.00</b>	148	2.0 (170PS) Turbo D auto BlueInjection*	23550.00	4710.00	28260.00	<b>29530.00</b>	148
<b>DESIGN NAV</b>						<b>TECH LINE NAV</b>					
1.5 (140PS) Turbo	17783.33	3556.67	21340.00	<b>22300.00</b>	131	1.5 (165PS) Turbo	19916.66	3983.34	23900.00	<b>24860.00</b>	131
1.5 (165PS) Turbo	18033.33	3606.67	21640.00	<b>22600.00</b>	131	1.5 (165PS) Turbo auto	21250.00	4250.00	25500.00	<b>26460.00</b>	144
1.5 (165PS) Turbo auto	19366.66	3873.34	23240.00	<b>24200.00</b>	144	<i>Diesel</i>					
<i>Diesel</i>						1.6 (110PS) Turbo D BlueInjection* ecoTEC	19950.00	3990.00	23940.00	<b>24900.00</b>	121
1.6 (110PS) Turbo D BlueInjection* ecoTEC	18066.67	3613.33	21680.00	<b>22640.00</b>	121	1.6 (136PS) Turbo D BlueInjection*	20366.67	4073.33	24440.00	<b>25400.00</b>	125
1.6 (136PS) Turbo D BlueInjection*	18483.33	3696.67	22180.00	<b>23140.00</b>	125	1.6 (136PS) Turbo D auto BlueInjection*	21700.00	4340.00	26040.00	<b>27310.00</b>	139
1.6 (136PS) Turbo D auto BlueInjection*	19816.66	3963.34	23780.00	<b>25050.00</b>	139	2.0 (170PS) Turbo D BlueInjection*	21033.33	4206.67	25240.00	<b>26510.00</b>	145
2.0 (170PS) Turbo D BlueInjection*	19150.00	3830.00	22980.00	<b>24250.00</b>	145	2.0 (170PS) Turbo D auto BlueInjection*	22366.66	4473.34	26840.00	<b>28110.00</b>	148
2.0 (170PS) Turbo D auto BlueInjection*	20483.33	4096.67	24580.00	<b>25850.00</b>	148	<b>ELITE NAV</b>					
<b>SRI</b>						1.5 (165PS) Turbo	22608.33	4521.67	27130.00	<b>28090.00</b>	131
1.5 (165PS) Turbo	19425.00	3885.00	23310.00	<b>24270.00</b>	131	1.5 (165PS) Turbo auto	23941.66	4788.34	28730.00	<b>29690.00</b>	144
1.5 (165PS) Turbo auto	20758.33	4151.67	24910.00	<b>25870.00</b>	144	1.6 (200PS) Turbo	23858.33	4771.67	28630.00	<b>29900.00</b>	151
<i>Diesel</i>						1.6 (200PS) Turbo auto	25900.00	5180.00	31080.00	<b>32350.00</b>	154
1.6 (110PS) Turbo D BlueInjection* ecoTEC	19458.33	3891.67	23350.00	<b>24310.00</b>	121	<i>Diesel</i>					
1.6 (136PS) Turbo D BlueInjection*	19875.00	3975.00	23850.00	<b>24810.00</b>	125	1.6 (110PS) Turbo D BlueInjection* ecoTEC	22641.66	4528.34	27170.00	<b>28130.00</b>	121
1.6 (136PS) Turbo D auto BlueInjection*	21208.33	4241.67	25450.00	<b>26720.00</b>	139	1.6 (136PS) Turbo D BlueInjection*	23058.33	4611.67	27670.00	<b>28630.00</b>	125
2.0 (170PS) Turbo D BlueInjection*	20541.66	4108.34	24650.00	<b>25920.00</b>	145	1.6 (136PS) Turbo D auto BlueInjection*	24391.66	4878.34	29270.00	<b>30540.00</b>	139
2.0 (170PS) Turbo D auto BlueInjection*	21875.00	4375.00	26250.00	<b>27520.00</b>	148	2.0 (170PS) Turbo D BlueInjection*	23725.00	4745.00	28470.00	<b>29740.00</b>	145
<b>SRI NAV</b>						2.0 (170PS) Turbo D auto BlueInjection*	25058.33	5011.67	30070.00	<b>31340.00</b>	148
1.5 (165PS) Turbo	20083.32	4016.68	24100.00	<b>25060.00</b>	131	2.0 (210PS) BiTurbo D 4X4 auto BlueInjection*	25554.16	5110.84	30665.00	<b>32660.00</b>	187
1.5 (165PS) Turbo auto	21416.66	4283.34	25700.00	<b>26660.00</b>	144	<b>GSI NAV</b>					
<i>Diesel</i>						2.0 (210PS) BiTurbo D 4X4 auto BlueInjection*	31437.50	6287.50	37725.00	<b>39720.00</b>	188
1.6 (110PS) Turbo D BlueInjection* ecoTEC	20116.67	4023.33	24140.00	<b>25100.00</b>	121	Please note: On-the-road recommended retail prices (RRP) include number plates and delivery to Retailer of £700.00 (inc. £116.67 VAT) 12 months' Vehicle Excise Duty and new vehicle first registration fee of £55.00. Excludes fuel and insurance.					
1.6 (136PS) Turbo D BlueInjection*	20533.33	4106.67	24640.00	<b>25600.00</b>	125	* = Please note: Vehicles with BlueInjection technology will need regular AdBlue® top-ups also between servicing requirements.					
1.6 (136PS) Turbo D auto BlueInjection*	21866.66	4373.34	26240.00	<b>27510.00</b>	139	An indicator integrated into the on-board computer will warn you when you need to top up. More information under <a href="http://www.vauxhall.co.uk/discover-vauxhall/technology/adblue.html">www.vauxhall.co.uk/discover-vauxhall/technology/adblue.html</a>					
2.0 (170PS) Turbo D BlueInjection*	21200.00	4240.00	25440.00	<b>26710.00</b>	145	In accordance with regulations R (EC) No. 715/2007 and R (EC) No. 692/2008 (in the versions respectively applicable).					
2.0 (170PS) Turbo D auto BlueInjection*	22533.33	4506.67	27040.00	<b>28310.00</b>	148						

# INSIGNIA PRICES

Model Country Tourer	Price (£)	VAT (£)	Total (£)	On-the-road RRP (£)	CO <sub>2</sub> (g/km)
<b>COUNTRY TOURER</b>					
<i>Diesel</i>					
2.0 (170PS) Turbo D BlueInjection*	21566.66	4313.34	25880.00	<b>27150.00</b>	150
2.0 (170PS) Turbo D auto BlueInjection*	22904.17	4580.83	27485.00	<b>29070.00</b>	151
2.0 (170PS) Turbo D 4X4 BlueInjection*	22404.17	4480.83	26885.00	<b>28470.00</b>	164
2.0 (210PS) BiTurbo D 4X4 auto BlueInjection*	23404.17	4680.83	28085.00	<b>30080.00</b>	188

Please note: On-the-road recommended retail prices (RRP) include number plates and delivery to Retailer of £700.00 (inc. £116.67 VAT) 12 months' Vehicle Excise Duty and new vehicle first registration fee of £55.00. Excludes fuel and insurance.

\* = Please note: Vehicles with BlueInjection technology will need regular AdBlue® top-ups also between servicing requirements.

An indicator integrated into the on-board computer will warn you when you need to top up. More information under [www.vauxhall.co.uk/discover-vauxhall/technology/adblue.html](http://www.vauxhall.co.uk/discover-vauxhall/technology/adblue.html)

In accordance with regulations R (EC) No. 715/2007 and R (EC) No. 692/2008 (in the versions respectively applicable).

# INSIGNIA FEATURES / OPTIONS

## SAFETY

### Driver / passenger airbags

- Driver's airbag • Front passenger's airbag • Two front seat side-impact airbags
- Full-size curtain airbags for driver and front and outer rear seat passengers

### Seating

- Height-adjustable front seat head restraints (excluding GSi Nav models) • Three height adjustable rear seat head restraints • Anti-submarining ramps in front seats – Prevents occupants sliding underneath the lap belt during a collision.

### Seatbelts

- Two front and three rear inertia-reel lap and diagonal seatbelts • Front and outer rear seatbelt pretensioner system – Pretensioners tighten the seatbelt in the event of an accident limiting forward movement.
- Front and outer rear seatbelt force limiters – Reduces potential upper body injuries during a frontal impact.
- Front 'seatbelt unfastened' audible warning and warning light

### Child safety

- Deactivation switch for front passenger's front and side-impact airbags – Permits the safe use of a child seat in the front passenger seat. • ISOFIX child seat mountings incorporating top tether anchor points located on outer rear seats (does not include child seat) – Allows ISOFIX child safety seats to be securely fixed into the car. The ISOFIX mounting system reduces forward movement in an accident and makes the child seat easier to install. • Child-proof locks on rear doors

### Driver / passenger safety

- Energy-absorbing steering column • Pedal release system – Reduces potential injury to the driver's legs and feet during a severe frontal impact. • Laminated windscreen • Side-impact protection beams • Reinforced passenger safety cell • Deformation zones front and rear
- Burst-proof door locks and anti-jam door design

### Pedestrian safety

- Active bonnet / headlight / wiper structure – Designed to reduce pedestrian head and upper body injuries. The active bonnet travels backwards and upwards to help prevent impact between pedestrian's head and underbonnet components.
- Upper and lower bumper design – Reduces upper and lower leg injuries.

### Stability

#### Electronic Stability Programme (ESP):

– Works in conjunction with the vehicle's electronic braking and engine systems to keep the car stable in many different situations. ESP monitors many different inputs to determine when the car starts to lose traction, it can then immediately respond by varying the brake pressure between up to three wheels and adjust the engine output to help correct the loss of traction and improve stability.

#### Additional ESP features:

- Traction control • Cornering brake control • Straight line stability control • Rollover mitigation • Drag torque control – Maintain stability on slippery roads when lifting off the accelerator or changing gear.

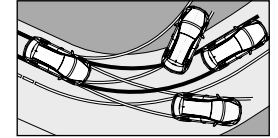

### Braking

#### Anti-lock Braking System (ABS):

– Prevents the vehicle's wheels from locking up under heavy braking by momentarily reducing brake pressure at the appropriate wheel, ensuring that you can maintain control of the steering.

#### Additional braking features:

- The same electronic systems used in the ABS and ESP also deliver exceptional braking performance.
- Emergency brake assist – When emergency braking is detected the vehicle automatically applies the maximum possible braking assistance. • Fading brake support – Compensates for the effects of brake fade • Electronic brakeforce distribution – Automatically apportions the optimum braking force to each wheel. • Adaptive brake lights – Automatically warns other road users of heavy braking.
- Hill start assist – Briefly maintains rear brake pressure to stop the vehicle rolling back on an incline.
- Hazard warning lights

### Tyre pressure

- Tyre pressure monitoring system



# INSIGNIA FEATURES / OPTIONS

<b>DRIVER ASSISTANCE</b>	Design / Design Nav	SRI / SRI Nav	SRI VX-Line Nav	Tech Line Nav	Elite Nav	GSi Nav	Country Tourer	Price (£) exc. VAT	Total (£) inc. VAT
<b>Electric parking brake</b> • Centre console switch in lieu of handbrake lever • Premium centre console featuring adjustable armrest	●	●	●	●	●	●	●		
<b>Steering</b> • Speed-sensitive electrically assisted power steering	●	●	●	●	●	●	●		
<b>Cruise control with speed limiter</b> <i>Cruise control enables you to maintain a constant speed – making it ideal for economical motorway driving. The speed limiter function can be set to ensure that you do not exceed the speed limit and can be easily overridden if required.</i> • Steering wheel mounted controls	●	●	●	●	●	●	●		
<b>FlexRide (available at extra cost on 2.0 (170PS) Turbo D, standard 1.6 (200PS) Turbo auto and 2.0 (210PS) BiTurbo D 4X4 models)</b> <i>Enables the driver to choose from three distinct driving modes – Normal (default setting), Sport or Tour.</i> • Facia mounted Sport and Tour switches • GSi models include a unique Competition mode	○	○	○	○	○	●	●	708.33	<b>850.00</b>

● = Standard equipment. ○ = Optional at extra cost.

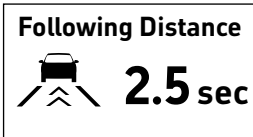

# INSIGNIA FEATURES / OPTIONS

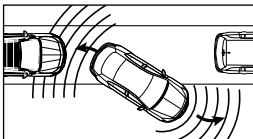
<b>DRIVER ASSISTANCE</b>		Design / Design Nav	SRI / SRI Nav	SRI VX-Line Nav	Tech Line Nav	Elite Nav	GSi Nav	Country Tourer	Price (£) exc. VAT	Total (£) inc. VAT
<p><b>Driving Assistance Pack One</b></p> <p><i>A wide range of class-leading driver assistance and safety features are controlled by the front camera system</i></p> <p><b>Forward collision alert with automatic city emergency braking:</b>  <i>In certain circumstances and at speeds above 5mph warns when approaching another vehicle too quickly. At speeds above 5mph and up to 50mph the system provides additional braking support to help the driver brake more quickly and effectively in an emergency situation. On dry roads at speeds above 5mph and up to 25mph the vehicle can brake to a full stop. At speeds above 25mph and up to 50mph, if no avoiding action is taken by the driver, the system automatically slows the vehicle with emergency braking.</i></p> <ul style="list-style-type: none"> <li>• Visual warnings – red LEDs projected onto windscreen and visual warning shown in the instrument cluster.</li> <li>• Audible warning • Additional braking support • Low speed collision mitigation braking</li> </ul> <p> <b>Collision Alert</b></p>										
<p><b>Following distance indicator:</b>  <i>Indicates how many seconds you are behind the vehicle in front – helping you maintain a safe distance.</i></p> <ul style="list-style-type: none"> <li>• Timings are shown in the driver information display</li> <li>• Warning light in the instrument cluster if the gap to the vehicle ahead is below that set by the driver</li> </ul> <p> <b>Following Distance</b> 2.5 sec</p>		●	●	●	●	●	●	●		
<p><b>Lane departure warning with lane assist:</b>  <i>If the driver has not actively steered or signalled, the lane departure warning system warns when the car moves outside of lane markings at speeds above 35mph. The lane assist function additionally provides gentle steering correction to help drivers keep in their lane if no active inputs are made.</i></p> <ul style="list-style-type: none"> <li>• Warning light in the instrument cluster • Audible warning • Steering wheel 'nudge' warning • Facia on / off switch</li> </ul> <p> <b>Lane Departure Warning</b></p>										
<p><b>Driving Assistance Pack Two – Automatic cruise control incorporating automatic brake intervention (not available on 1.6 (110/136) Turbo D models)</b></p> <p><i>Automatic cruise control adjusts the vehicle's speed to maintain a time distance to the preceding vehicle, up to the speed that you have set. On models with automatic transmission the 'Stop and Go' function will bring the vehicle to a complete stop and then set off again as the traffic ahead moves away. Automatic brake intervention is active at all speeds above walking pace (2.5mph).</i></p>			○	○	○	○	○	○	475.00	570.00
<p><b>Front and rear parking distance sensors (not available with Driving Assistance Pack Three or Four)</b></p> <ul style="list-style-type: none"> <li>• Audible warning • Distance warning graphic shown in driver information display</li> </ul> <p> <b>Front and rear parking distance sensors</b></p>		○	●	●	●	●	●	●	383.33	460.00

● = Standard equipment. ○ = Optional at extra cost.

# INSIGNIA FEATURES / OPTIONS

## DRIVER ASSISTANCE

### Driving Assistance Pack Three (only available on Nav models and in conjunction with Power Seat Pack. Includes front and rear parking distance sensors)

Intelligent ultrasonic sensors form part of the solution for today's crowded roads and car parks – delivering exceptional assistance both when parking and protecting you on the open road.

- Electrically foldable door mirrors with puddle lights

#### Advanced park assist:

Advanced park assist not only detects suitable parking spaces but also expertly steers into them for you. All you have to do is to drive forward or reverse. The system works with both parallel and bay parking.

- Ultrasonic side sensors with four-metre range
- Ultrasonic front and rear parking sensors with a two-metre range
- Fully automated steering
- On automatic models, braking is automated
- Detailed forward/reverse instructions are shown in the instrument cluster or central facia display

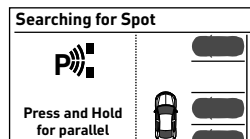

- ✓ Finds suitable parking spaces
- ✓ Auto steers into the parking space for you

#### Lane change assist with side blind spot alert:

Lane change assist with side blind spot alert helps prevent potential collisions with other vehicles 'hidden' in the vehicle's side blind spots. If a vehicle enters one of the blind spots a warning light illuminates in the relevant door mirror.

- Ultrasonic side sensors identify vehicles within three-metre range
- LED warning light in door mirrors, flashes when indicators are used
- Audible warning is sounded if the indicators are used and the system has detected another vehicle
- Radar sensors with 70-metre range identify traffic approaching quickly from behind

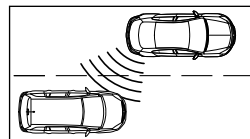

- ✓ Warns of vehicles in your blind spot

#### 360° panoramic camera:

The camera gives a clear view of the area all around your car and helps place the car perfectly, without needing to strain your neck.

- Activated when reverse gear selected, when switched on manually or when very close to an object ahead of or behind the vehicle
- Camera views appear in infotainment screen
- Overhead view displayed on the left side of the screen allows you to see clearly how close you are to obstacles in front of and behind you
- Right side of the screen displays front or rear view, depending on gear selected
- Rear bumper and grid lines shown as reference points

- ✓ See what's behind you on the central screen

#### Rear cross traffic alert:

As you reverse the car, this system detects vehicles approaching from the rear and side.

- Radar sensors with 20-metre range identify approaching vehicles
- Warning light in central facia display
- Audible warning on relevant side of car

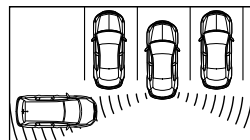

	Design / Design Nav	SRI / SRI Nav	SRI VX-Line Nav	Tech Line Nav	Elite Nav	GSi Nav	Country Tourer	Price (£) exc. VAT	Total (£) inc. VAT
Driving Assistance Pack Three (only available on Nav models and in conjunction with Power Seat Pack. Includes front and rear parking distance sensors)									
Lane change assist with side blind spot alert:		○	○	○	○	○	○	854.17	1025.00
360° panoramic camera:									
Rear cross traffic alert:									

○ = Optional at extra cost.

# INSIGNIA FEATURES / OPTIONS

## DRIVER ASSISTANCE

**Driving Assistance Pack Four (only available on Nav models. Design Nav models require optional Sight and Light Pack. Includes front and rear parking distance sensors. Not available with optional power driver's seat)**

*Intelligent ultrasonic sensors form part of the solution for today's crowded roads and car parks – delivering exceptional assistance both when parking and protecting you on the open road.*

- Electrically foldable door mirrors with puddle lights

### Lane change assist with side blind spot alert:

*Lane change assist with side blind spot alert helps prevent potential collisions with other vehicles 'hidden' in the vehicle's side blind spots. If a vehicle enters one of the blind spots a warning light illuminates in the relevant door mirror.*

- Ultrasonic side sensors identify vehicles within three-metre range
- LED warning light in door mirrors, flashes when indicators are used
- Audible warning is sounded if the indicators are used and the system has detected another vehicle
- Radar sensors with 70-metre range identify traffic approaching quickly from behind

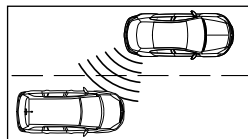

- Warns of vehicles in your blind spot

### Rear-view camera:

*The rear-view camera gives a clear view of the area behind your car and helps place the car perfectly, without needing to strain your neck.*

- Activated when reverse gear selected
- Camera view appears in infotainment screen
- Rear bumper and grid lines shown as reference points

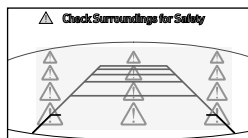

- See what's behind you on the central screen

### Rear cross traffic alert:

*As you reverse the car, this system detects vehicles approaching from the rear and side.*

- Radar sensors with 20-metre range identify approaching vehicles
- Warning light in central facia display
- Audible warning on relevant side of car

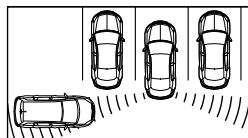

○ = Optional at extra cost.

	Design / Design Nav	SRI / SRI Nav	SRI VX-Line Nav	Tech Line Nav	Elite Nav	GSi Nav	Country Tourer	Price (£) exc. VAT	Total (£) inc. VAT
Driving Assistance Pack Four (only available on Nav models. Design Nav models require optional Sight and Light Pack. Includes front and rear parking distance sensors. Not available with optional power driver's seat)	○	○	○	○	○	○	○	541.67	650.00

# INSIGNIA FEATURES / OPTIONS

	Design / Design Nav	SRI / SRI Nav	SRI VX-Line Nav	Tech Line Nav	Elite Nav	GSi Nav	Country Tourer	Price (£) exc. VAT	Total (£) inc. VAT
<b>SECURITY</b>									
<b>Standard security features</b> • Electronically protected audio equipment • Engine deadlock immobiliser • Visible Vehicle Identification Number (VIN) • Locking wheel bolts for alloy wheels • Freewheeling door locks	●	●	●	●	●	●	●		
<b>Remote control central locking</b> • Operates on doors, tailgate and fuel filler flap • Deadlocking • Central locking activation switch on driver's door • Keyless entry with two transmitter fobs	●	●	●	●	●	●	●	250.00	300.00
<b>Remote control ultrasonic security alarm system</b> • Remote control (operates in conjunction with central locking) • Ultrasonic interior sensors • Tilt sensor • Independent power supply • Thatcham approved (T1)	●	●	●	●	●	●	●		
Keyless start with engine start/stop button	●	●	●	●	●	●	●		
<b>DRIVER INFORMATION</b>									
<b>Instrumentation</b> • Speedometer • Rev counter • Digital fuel gauge with low fuel level warning light • Digital water temperature gauge with warning light • Shift-up/down indication light – <i>Indicates when to change gear for optimum fuel economy.</i>	●	●	●	●	●	●	●		
<b>Driver information display (centrally located in instrument cluster)</b> <b>Displays:</b> • Trip computer data • Total mileage • Service-due indicator • Oil life • Tyre pressure monitoring system • 3.5-inch monochrome display • 8-inch colour display incorporating speedometer and supplementary audio, phone and navigation information (standard on 1.6 (200PS) Automatic models)	●	●	●	●	●	●	●		
<b>Head-up display (only available with Multimedia Navi Pro)</b> <i>Projects key information onto the windscreen so that the driver's eyes remain on the road at all times. The display is adjustable for height and brightness.</i> <b>Displays:</b> • Navigation directions • Audio and phone information • Speedometer • Rev counter • Selected gear and gear shift indicator • Set speed of cruise control and speed limiter • Forward collision alert • Following distance indicator gap adjustment • Lane assist and lane departure warning • Pedestrian alert <i>Please note: The red LEDs of the forward collision alert system are replaced by a warning symbol</i>		○	○	○	○	●	○	241.67	290.00
<b>Multi-function trip computer (displayed on driver information display)</b> • Trip mileage • Vehicle range based on remaining fuel • Average speed • Average fuel economy • Instantaneous fuel economy • Driving time	●	●	●	●	●	●	●		
<b>Central facia display (format dependent on infotainment unit)</b> • Audio information • Digital clock with automatic RDS time adjustment • Outside air temperature with ice warning function • Additional features dependent on infotainment unit (see infotainment for details)	●	●	●	●	●	●	●		

● = Standard equipment. ○ = Optional at extra cost. □ = Available as part of an extra-cost option pack.

# INSIGNIA FEATURES / OPTIONS

<b>INTERIOR STYLING</b>	Design / Design Nav	SRI / SRI Nav	SRI VX-Line Nav	Tech Line Nav	Elite Nav	GSi Nav	Country Tourer	Price (£) exc. VAT	Total (£) inc. VAT
<b>Design interior décor</b> Steering wheel: • Three-spoke design • Leather-covered • Satin chrome-effect bezel Facia and door trim: • Black facia • Black door panels with black Atlantis cloth inserts • Metallic silver Raute trim inserts • Chrome-effect interior door handles Headlining: • Light fabric	●								
<b>SRI interior décor</b> Steering wheel: • Three-spoke design • Leather-covered, perforated • Satin chrome-effect bezel Facia and door trim: • Black facia • Silver air vent surrounds • Black door panels with black Morrocana inserts (standard seats); black leather-effect inserts (optional AGR active seats) • Dark metallic Hexagon trim inserts • Chrome-effect interior door handles Pedals: • Sports, alloy-effect Headlining: • Light fabric		●							
<b>SRI VX-Line Nav interior décor</b> Steering wheel: • Three-spoke VX-Line design, flat bottom • Leather-covered, perforated • Electrically heated • Satin chrome-effect bezel Facia and door trim: • Black facia • Silver air vent surrounds • Black door panels with black Morrocana inserts (standard seats); black leather-effect inserts (optional AGR active seats) • Dark metallic Hexagon trim inserts • Chrome-effect interior door handles Pedals: • Sports, alloy-effect Headlining: • Dark fabric			●						
<b>Tech Line Nav / Country Tourer interior décor</b> Steering wheel: • Three-spoke design • Leather-covered • Satin chrome-effect bezel Facia and door trim: • Black facia • Black door panels with black leather-effect inserts • Dark silver Agate trim inserts • Chrome-effect interior door handles Headlining: • Light fabric Floor mats: • Velour, front and rear (Country Tourer models only) Front door sill covers: • Alloy-effect				●			●		
<b>Elite Nav interior décor</b> Steering wheel: • Three-spoke design • Leather-covered • Satin chrome-effect bezel Facia and door trim: • Black facia • Silver air vent surrounds • Black door panels with black leather-effect inserts • Dark silver Agate trim inserts • Chrome-effect interior door handles Headlining: • Light fabric Front door sill covers: • Alloy-effect					●				

● = Standard equipment. \* = AGR (The Campaign for Healthier Backs) is an independent centre of excellence for ergonomics, based in Germany.

# INSIGNIA FEATURES / OPTIONS

## INTERIOR STYLING

	Design / Design Nav	SRI / SRI Nav	SRI VX-Line Nav	Tech Line Nav	Elite Nav	GSI Nav	Country Tourer	Price (£) exc. VAT	Total (£) inc. VAT
<b>GSI Nav interior décor</b> Steering wheel: • Three-spoke VX-Line design, flat bottom • Leather-covered, perforated • Electrically heated • Satin chrome-effect bezel Facia and door trim: • Black facia • Silver air vent surrounds • Black door panels with black leather-effect inserts • Dark metallic Hexagon trim inserts • Chrome-effect interior door handles Pedals: • Sports, alloy-effect Headlining: • Dark fabric Floor mats: • Velour, front and rear Front door sill covers: • Alloy-effect						●			
<b>VX-Line Interior Pack</b> Steering wheel: • Three-spoke VX-Line design, flat bottom • Leather-covered, perforated • Electrically heated • Satin chrome-effect bezel • Paddle shift on automatic models Pedals: • Sports, alloy-effect Headlining: • Dark fabric		○	●	○	○	●	○	337.50	<b>405.00</b>

● = Standard equipment. ○ = Optional at extra cost.

# INSIGNIA FEATURES / OPTIONS

<b>SEATING AND COMFORT</b>	Design / Design Nav	SRI / SRI Nav	SRI VX-Line Nav	Tech Line Nav	Elite Nav	GSi Nav	Country Tourer	Price (£) exc. VAT	Total (£) inc. VAT
Reach and rake adjustable steering	●	●	●	●	●	●	●		
<b>Cloth front seats</b> <b>Driver's seat (eight-way adjustable):</b> • Height • Reach • Backrest • Head restraint <b>Front passenger's seat (six-way adjustable):</b> • Reach • Backrest • Head restraint <b>Seat trim:</b> • Milano fabric seat trim inserts • Plain black fabric side bolsters	●								
<b>Cloth front seats</b> <b>Ergonomic active driver's seat (16-way adjustable):</b> • Height • Reach • Tilt • Backrest • Lumbar adjustment (four-way electrical) • Head restraint (four-way) <b>Front passenger's seat (eight-way adjustable):</b> • Reach • Backrest • Head restraint (four-way) <b>Seat trim:</b> • Monita fabric seat trim inserts • Black Premium leather effect side bolsters				●			●		
<b>Ergonomic active front seats (AGR-approved*)</b> <b>Driver's seat (18-way adjustable):</b> • Height • Reach • Tilt • Backrest • Seat cushion extension • Lumbar adjustment (four-way electrical) • Head restraint (four-way) <b>Front passenger's seat (eight-way adjustable):</b> • Reach • Backrest • Head restraint (four-way) <i>Please note: On Design models the driver's and front passenger's head restraints are only adjustable up and down.</i> <b>Seat trim:</b> • Monita fabric seat trim inserts • Black Premium leather effect side bolsters		●	●						
• Milano fabric seat trim inserts • Plain black fabric side bolsters (Ergonomic active driver's seat)	○							354.17	425.00
<b>Ergonomic active front seats (AGR-approved*)</b> <b>Driver's and front passenger's seat (18-way adjustable):</b> • Height • Reach • Tilt • Backrest • Seat cushion extension • Lumbar adjustment (four-way electrical) • Head restraint (four-way) • Heated front seats <b>Seat trim:</b> • Black Siena perforated leather seat trim inserts • Black Premium leather effect side bolsters		○	○	○	●		○	962.50	1155.00

● = Standard equipment. ○ = Optional at extra cost. \* = AGR (The Campaign for Healthier Backs) is an independent centre of excellence for ergonomics, based in Germany.

# INSIGNIA FEATURES / OPTIONS

<b>SEATING AND COMFORT</b>	Design / Design Nav	SRI / SRI Nav	SRI VX-Line Nav	Tech Line Nav	Elite Nav	GSi Nav	Country Tourer	Price (£) exc. VAT	Total (£) inc. VAT
<b>Premium ergonomic active front seats (AGR-approved*)</b> <b>Driver's and front passenger's seat (14-way adjustable):</b> • Height (electrical) • Reach (electrical) • Tilt (electrical) • Backrest (electrical) • Seat cushion extension • Lumbar adjustment (four-way electrical) • Massage functions • Active ventilation • Pneumatically adjustable backrest side bolsters • Driver's seat memory function, including door mirrors • Heated front seats • Heated outer rear seats • FlexFold 40/20/40 split-folding rear seat back <b>Seat trim:</b> • Black Siena perforated leather seat trim inserts • Black Premium leather effect side bolsters						●			
<b>Power driver's seat (only available in conjunction with leather Ergonomic active front seats. Not available with optional Driving Assistance Pack Four)</b> <b>The following features are electrically adjustable:</b> • Height • Reach • Tilt • Backrest • Lumbar adjustment • Massage functions • Pneumatically adjustable backrest side bolsters • Driver's seat memory function, including door mirrors • Active ventilation for driver's and front passenger's seats • Electrically foldable door mirrors with puddle lights		○	○	○	○		○	566.67	<b>680.00</b>
<b>Power driver's seat (only available on models with cloth trim. Not available with optional Driving Assistance Pack Four)</b> <b>The following features are electrically adjustable:</b> • Height • Reach • Tilt • Backrest • Lumbar adjustment • Massage functions • Pneumatically adjustable backrest side bolsters • Driver's seat memory function, including door mirrors • Heated front seats • Electrically foldable door mirrors with puddle lights		○	○					425.00	<b>510.00</b>
<b>Rear seating</b> • Three person layout • Three height-adjustable and removable head restraints • ISOFIX child seat mountings incorporating top tether anchor points located on outer rear seats (does not include child seat) – <i>Allows ISOFIX child safety seats to be securely fixed into the car.</i> <i>The ISOFIX mounting system reduces forward movement in an accident and makes the child seat easier to install.</i> • Child-proof locks on rear doors • 60/40 split-folding rear seat back • FlexFold 40/20/40 split-folding rear seat back with one-touch release • Centre rear armrest	●			●					
	●			●					
		●	●		●	●	●		
		●	●		●	●	●		

● = Standard equipment. ○ = Optional at extra cost. \* = AGR (The Campaign for Healthier Backs) is an independent centre of excellence for ergonomics, based in Germany.



# INSIGNIA FEATURES / OPTIONS

<b>INFOTAINMENT</b>	Design / Design Nav	SRI / SRI Nav	SRI VX-Line Nav	Tech Line Nav	Elite Nav	GSi Nav	Country Tourer	Price (£) exc. VAT	Total (£) inc. VAT
<p><b>Multimedia touchscreen infotainment system</b></p> <p><b>Onboard features:</b></p> <ul style="list-style-type: none"> <li>• 7-inch colour touchscreen featuring tablet-like controls including swipe gestures</li> <li>• DAB digital radio/AM/FM stereo radio • RDS with Traffic Programme</li> </ul> <hr/> <p><b>Media connections:</b></p> <ul style="list-style-type: none"> <li>• USB connection with iPod control in front centre armrest • Bluetooth® A2DP audio streaming (Advanced Audio Distribution Profile)</li> </ul> <hr/> <p><b>Mobile phone portal:</b></p> <ul style="list-style-type: none"> <li>• Bluetooth® connectivity • Handsfree calls via steering wheel controls • Vehicle microphone</li> <li>• Phone book access – <i>Contacts/last calls/missed calls etc. are mirrored on Multimedia display and are easily navigated using the touchscreen (features dependent on mobile phone).</i></li> </ul> <hr/> <p><b>Smartphone interface:</b></p> <ul style="list-style-type: none"> <li>• Apple CarPlay™ • Android Auto™</li> <li>– <i>Smartphone projection that allows operations via voice command, touchscreen and buttons to control apps and music playback.</i></li> </ul>	●	●							
<p><b>Multimedia Navi touchscreen navigation and infotainment system</b></p> <p><b>Onboard features:</b></p> <ul style="list-style-type: none"> <li>• 7-inch colour touchscreen • DAB digital radio/AM/FM stereo radio with 36 station presets • RDS with Traffic Programme</li> </ul> <hr/> <p><b>Navigation features:</b></p> <ul style="list-style-type: none"> <li>• Satellite navigation system</li> </ul> <hr/> <p><b>Media connections:</b></p> <ul style="list-style-type: none"> <li>• USB connection with iPod control • Bluetooth® A2DP audio streaming (Advanced Audio Distribution Profile)</li> </ul> <hr/> <p><b>Mobile phone portal:</b></p> <ul style="list-style-type: none"> <li>• Bluetooth® connectivity • Handsfree calls via steering wheel controls • Vehicle microphone</li> <li>• Phone book access – <i>Contacts/last calls/missed calls etc. are mirrored on display and are easily navigated using the touchscreen (features dependent on mobile phone).</i></li> </ul> <hr/> <p><b>Smartphone interface:</b></p> <ul style="list-style-type: none"> <li>• Apple CarPlay™ • Android Auto™ – <i>Smartphone projection that allows operations via voice command, touchscreen and buttons to control apps and music playback.</i></li> </ul> <hr/> <p><b>Traffic sign recognition:</b></p> <ul style="list-style-type: none"> <li>• Recognises different road signs, including temporary speed restrictions</li> <li>• Displays reminder in the driver information centre</li> </ul>	▲	▲	●	●			●		

● = Standard equipment. ▲ = Standard on Nav models, see pricing page for details.

# INSIGNIA FEATURES / OPTIONS

## INFOTAINMENT

	Design / Design Nav	SRI / SRI Nav	SRI VX-Line Nav	Tech Line Nav	Elite Nav	GSi Nav	Country Tourer	Price (£) exc. VAT	Total (£) inc. VAT
<b>Multimedia Navi Pro touchscreen navigation and infotainment Pack (standard on 1.6 (200PS) Automatic and Country Tourer 4X4 models)</b> <b>Onboard features:</b> <ul style="list-style-type: none"> <li>8-inch colour touchscreen featuring tablet-like controls including swipe gestures</li> <li>DAB digital radio/AM/FM stereo radio</li> <li>RDS with Traffic Programme</li> <li>60 configurable favourites including contacts, addresses, playlists and radio stations</li> <li>Voice control for audio, phone and navigation functions</li> <li>Stores up to 5 user profiles for simple retrieval</li> </ul> <b>Navigation features:</b> <ul style="list-style-type: none"> <li>Satellite navigation system</li> <li>Integrated 3D European navigation with Traffic Message Channel TMC/TPEG</li> <li>Connected navigation services<sup>1</sup> such as predictive navigation and live traffic alerts, parking information, online map updates, routing and POI search</li> </ul> <b>Media connections:</b> <ul style="list-style-type: none"> <li>USB connection with iPod control in front centre armrest</li> <li>Bluetooth® A2DP audio streaming (Advanced Audio Distribution Profile)</li> </ul> <b>Mobile phone portal:</b> <ul style="list-style-type: none"> <li>Bluetooth® connectivity</li> <li>Handsfree calls via steering wheel controls</li> <li>Voice control support from connected phone</li> <li>Phone book access – <i>Contacts/last calls/missed calls etc. are mirrored on Multimedia display and are easily navigated using the touchscreen (features dependent on mobile phone).</i></li> <li>SMS read out and reply</li> </ul> <b>Instrumentation:</b> <ul style="list-style-type: none"> <li>8-inch colour display incorporating speedometer and supplementary audio, phone and navigation information (standard on 1.6 (200PS) Automatic models)</li> </ul> <b>Smartphone interface:</b> <ul style="list-style-type: none"> <li>Apple CarPlay™</li> <li>Android Auto™ – <i>Smartphone projection that allows operations via voice command, touchscreen and buttons to control apps and music playback.</i></li> </ul> <b>Traffic sign recognition:</b> <ul style="list-style-type: none"> <li>Recognises different road signs, including temporary speed restrictions</li> <li>Displays reminder in the driver information centre and, where fitted, the optional head-up display</li> </ul>	○	○	○	○	●	●	○	966.67	1160.00
Seven speakers (five front, two rear)	●	●	●	●	●		●		
<b>Bose® Premium Sound System (only available with Multimedia Navi Pro, standard on 2.0 (210PS) BiTurbo D 4X4 models. Not available in conjunction with optional emergency spare wheel)</b> <ul style="list-style-type: none"> <li>4x45w channels</li> <li>Bose® digital amplifier with six channels of customised equalisation</li> <li>7 premium speakers</li> <li>Subwoofer</li> </ul>		○	○	○	○	●	○	583.33	700.00
Steering wheel mounted audio controls for phone, music and cruise control	●	●	●	●	●	●	●		
Twin USB power sockets for rear seat passengers		●	●	●	●	●	●		
Wireless charger for mobile devices (Maximum device dimensions 75.7 x 23.6mm. Not suitable for Samsung Galaxy S8, S8 plus models)	○	○	○	○	○	○	○	133.33	160.00

● = Standard equipment. ○ = Optional at extra cost. 1 = Requires acceptance of Telenav end user licence agreement and consent to the use of personal data as set out in the Telenav privacy policy.

# INSIGNIA FEATURES / OPTIONS

	Design / Design Nav	SRI / SRI Nav	SRI VX-Line Nav	Tech Line Nav	Elite Nav	GSi Nav	Country Tourer	Price (£) exc. VAT	Total (£) inc. VAT
<b>HEATING AND VENTILATION</b> <b>Air conditioning</b> <ul style="list-style-type: none"> <li>• Air recirculation facility</li> <li>• Cabin particulate filter – Removes dust, airborne particles and pollen.</li> <li>• Multi-speed fan</li> <li>• Illuminated controls</li> <li>• Rear floor heating ducts</li> </ul>	●								
<b>Electronic climate control including air conditioning</b> <ul style="list-style-type: none"> <li>• Dual-zone control – Allowing different temperature settings for driver and front passenger.</li> <li>• Automatic front seat heating – On models ordered with Winter Pack or leather trim, front seat heating is switched on automatically to help achieve the requested interior temperature.</li> <li>• Advanced predictive logic control system using sun and humidity sensors</li> <li>• Partial air recirculation – Faster warm up/cool down.</li> <li>• Cabin particulate filter – Removes dust, airborne particles and pollen.</li> <li>• Automatic air direction and fan speed with manual override</li> <li>• LCD temperature display</li> <li>• Illuminated controls</li> <li>• Rear floor heating ducts</li> </ul> <div style="display: flex; justify-content: space-between;"> <div style="background-color: #f0f0f0; padding: 2px;"> Set and forget temperature control</div> <div style="background-color: #f0f0f0; padding: 2px;"> Set different temperature for driver and front passenger</div> </div>	○	●	●	●	●	●	●	337.50	405.00
<b>Additional features</b> <ul style="list-style-type: none"> <li>• Four adjustable facia vents</li> <li>• Windscreen demist vents</li> <li>• Side window demist vents</li> </ul>	●	●	●	●	●	●	●		
<b>Winter Pack One – models with cloth trim, without VX-Line Interior Pack</b> <ul style="list-style-type: none"> <li>• Heated leather-covered steering wheel</li> <li>• Heated front seats – Three temperature settings.</li> <li>• Heated windscreen</li> </ul> <div style="background-color: #f0f0f0; padding: 2px;"> Warm welcome</div>		○		○			○	550.00	660.00
<b>Winter Pack Two – models with leather trim, without VX-Line Interior Pack</b> <ul style="list-style-type: none"> <li>• Heated leather-covered steering wheel</li> <li>• Heated windscreen</li> </ul> <div style="background-color: #f0f0f0; padding: 2px;"> Warm welcome</div>		○		○	○		○	333.33	400.00
<b>Winter Pack Three – models with leather trim and VX-Line Interior Pack</b> <ul style="list-style-type: none"> <li>• Heated windscreen</li> </ul>		○	○	○	○	○	○	125.00	150.00
<b>Winter Pack Four – models with cloth trim and VX-Line Interior Pack</b> <ul style="list-style-type: none"> <li>• Heated front seats – Three temperature settings.</li> <li>• Heated windscreen</li> </ul> <div style="background-color: #f0f0f0; padding: 2px;"> Warm welcome</div>		○	○	○			○	341.67	410.00

● = Standard equipment. ○ = Optional at extra cost.

# INSIGNIA FEATURES / OPTIONS

<b>INTERIOR CONVENIENCE / LIGHTING</b>	Design / Design Nav	SRI / SRI Nav	SRI VX-Line Nav	Tech Line Nav	Elite Nav	GSi Nav	Country Tourer	Price (£) exc. VAT	Total (£) inc. VAT
<b>Convenience features</b> • Front 12-volt electrical accessory socket • Driver's and front passengers sunvisors • Driver's and front passenger's vanity mirrors • Dipping rear-view mirror	●	●	●	●	●	●	●		
Automatically dimming anti-dazzle rear-view mirror – <i>On Design models, fitted in conjunction with Sight and Light Pack. Not available separately.</i>	□	●	●	●	●	●	●		
Front centre adjustable armrest with 4-litre storage capacity (2.8 litres if optional wireless charger is ordered)	●	●	●	●	●	●	●		
<b>Standard ambient lighting</b> • Central front courtesy light • Central rear courtesy light • Fade up/fade down • Twin front reading lights with illuminated switches • Twin rear reading lights • Ambient LED facia/centre console downlighter	●	●	●	●	●	●	●		
<b>Premium ambient lighting</b> • Driver's and front passenger's LED illuminated vanity mirrors with flip-up covers • Ambient LED lighting in front doors and below audio unit		●	●	●	●	●	●		
<b>Interior storage</b> • Illuminated glovebox with lid • Front door pockets with 1.5-litre bottle holder • Two drinks holders in centre console • Rear door pockets with 1-litre bottle holder	●	●	●	●	●	●	●		
• Storage pockets on front seat backs		●	●	●	●		●		
<b>Luggage area</b> • Luggage compartment cover (Grand Sport models) • Luggage compartment retractable cover (Sports Tourer / Country Tourer models) • Illuminated load area • Fully carpeted load area • Interior tailgate handle • Four load restraint lashing eyes • Twin gas-assisted tailgate struts • Storage tray in spare wheel well	●	●	●	●	●	●	●		
Luggage compartment 12-volt electrical accessory socket (Sports Tourer / Country Tourer models)		●	●	●	●	●	●		
<b>FlexOrganiser® Pack (Sports Tourer / Country Tourer models)</b> • Four side rails • 3D storage net • Side net pocket • Four side rail hooks	○	○	○	○	○	●	○	100.00	120.00



● = Standard equipment. ○ = Optional at extra cost. □ = Available as part of an extra-cost option pack.

# INSIGNIA FEATURES / OPTIONS

	Design / Design Nav	SRI / SRI Nav	SRI VX-Line Nav	Tech Line Nav	Elite Nav	GSi Nav	Country Tourer	Price (£) exc. VAT	Total (£) inc. VAT
<b>EXTERIOR LIGHTING</b>									
<b>Standard lighting features</b>									
<ul style="list-style-type: none"> <li>• LED daytime running lights • LED tail lights • Automatic lighting control: When the automatic lighting control is switched on, the system switches between daytime running lights and headlights automatically depending on external lighting conditions.</li> <li>• LED side repeat indicators • Lights-on audible warning: When driver's door is opened an audible warning sounds to alert the lights have been left on.</li> <li>• Manual headlight beam levelling: Use to adapt headlight range to the vehicle load to prevent dazzling. • LED brake lights</li> <li>• High-level LED centre rear brake light • Rear fog light • Reversing light • Hazard warning lights • Door-to-door illumination: Headlights illuminate the area for an adjustable time after leaving the vehicle. • Welcome lighting: Headlights and tail lights illuminate when the vehicle is unlocked.</li> </ul>	●	●	●	●	●	●	●		
<ul style="list-style-type: none"> <li>• Automatic lighting control with tunnel detection – on Design models, fitted in conjunction with Sight and Light Pack. Not available separately.</li> </ul>	□	●	●	●	●	●	●		
Front fog lights – also fitted as part of Plus Pack on Design and Tech Line Nav models, where available.	○	●	●	○	●		●	141.67	170.00
<b>IntelliLux LED® Matrix headlights</b>									
<p>IntelliLux LED® Matrix headlights work with the standard Driving Assistance Pack One incorporating front camera system, to provide outstanding lighting performance and enhanced safety. Each headlight features a matrix of 16 individual LED lights. These lights replace both the dipped beam and main beam functions. Each LED illuminates a separate part of the road ahead meaning that by automatically switching lights on and off, illumination is varied to suit traffic and road conditions.</p> <p>The IntelliLux system calculates which LED lights are activated and deactivated using additional data such as ambient light conditions, vehicle speed, steering angle and when the indicators are used. For example, when the front camera system detects an oncoming vehicle, the individual LED lights that would dazzle the oncoming driver are automatically switched off and then switched back on once the vehicle has passed. All other areas remain fully illuminated.</p> <p><b>Every type of driving environment has been considered:</b></p> <p><b>Urban light:</b> With street lighting and speeds up to 34mph, the system automatically enhances the dipped beam function.</p> <p><b>Highway light:</b> The system recognises when the car is on a dual carriageway or motorway. At higher speeds the light distribution on the right is reduced to minimise glare from the crash barriers whilst the left-side beam is lengthened.</p> <p><b>Country light:</b> As speeds increase, so does the lighting's performance, illuminating the nearside of the road.</p> <p><b>Static Cornering light:</b> At lower speeds corners and bends are illuminated to match steering inputs.</p> <p><b>Parking light:</b> When reversing, additional side-facing lights are activated in the headlights.</p> <p><b>Tourist mode:</b> The lighting pattern can be adjusted when travelling abroad.</p> <p><b>Energy saving mode:</b> The IntelliLux LED® Matrix system goes into energy saving mode when the engine is automatically stopped.</p> <ul style="list-style-type: none"> <li>• Dipped beam, main beam and dynamic lighting: 32 electronically controlled LED lights (16 per headlight)</li> <li>• Intelligent main beam control • Automatic headlight levelling</li> </ul>									
<ul style="list-style-type: none"> <li>✔ Smart headlights automatically adjust the shape of high beam</li> <li>✔ No need to switch between high and low beam</li> <li>✔ High beam is always glare free</li> </ul>									
<ul style="list-style-type: none"> <li>• Dipped beam, main beam and dynamic lighting: 32 electronically controlled LED lights (16 per headlight)</li> <li>• Intelligent main beam control • Automatic headlight levelling</li> </ul>									
<ul style="list-style-type: none"> <li>• Dipped beam, main beam and dynamic lighting: 32 electronically controlled LED lights (16 per headlight)</li> <li>• Intelligent main beam control • Automatic headlight levelling</li> </ul>									
<ul style="list-style-type: none"> <li>• Dipped beam, main beam and dynamic lighting: 32 electronically controlled LED lights (16 per headlight)</li> <li>• Intelligent main beam control • Automatic headlight levelling</li> </ul>									
<b>Sight and Light Pack</b>	○	●	●	●	●	●	●	200.00	240.00
<ul style="list-style-type: none"> <li>• Automatic lighting control with tunnel detection • Rain-sensitive windscreen wipers</li> <li>• Automatically dimming anti-dazzle rear-view mirror • High beam assist</li> </ul>									

● = Standard equipment. ○ = Optional at extra cost. □ = Available as part of an extra-cost option pack.

# INSIGNIA FEATURES / OPTIONS

	Design / Design Nav	SRI / SRI Nav	SRI VX-Line Nav	Tech Line Nav	Elite Nav	GSi Nav	Country Tourer	Price (£) exc. VAT	Total (£) inc. VAT
<b>EXTERIOR CONVENIENCE</b>									
<b>Windscreen wipers</b>	●	●	●	●	●	●	●		
• Two-speed windscreen wipers with variable intermittent wipe									
• Rain-sensitive windscreen wipers – <i>On Design models, fitted in conjunction with Sight and Light Pack. Not available separately.</i>	□	●	●	●	●	●	●		
• Intermittent rear window wash/wipe (Grand Sport models)	N/C	N/C	N/C	N/C	N/C	N/C		<b>No-cost option</b>	
• Intermittent rear window wash/wipe (Sports Tourer / Country Tourer models)	●	●	●	●	●	●	●		
<b>Door mirrors</b>	●	●	●	●	●	●	●		
• Twin electrically adjustable/heated door mirrors • Manually folding door mirrors									
• Electrically foldable door mirrors with puddle lights – <i>Fitted as part of Driving Assistance Pack Three and Four and in conjunction with power driver's seat. Not available separately.</i>	□	□	□	□	□	●	□		
<b>Windows</b>	●	●	●	●	●	●	●		
• Electrically operated front and rear windows with safety autoreverse and one-touch up/down facility • Heated rear window									
• Solar heat-absorbing windscreen • Tinted windows	●	●	●	●	●	●	●		
• Dark-tinted rear windows					●	●	●		
• Noise-reducing laminated side windows	○	○	○	○	○	○	○	183.33	<b>220.00</b>
<b>Power tailgate (Sports Tourer / Country Tourer models)</b>									
• Keyless entry with two transmitter fobs • Under-bumper release sensor • Tailgate close switch		○	○	○	○		○	566.67	<b>680.00</b>
• Maximum opening height can be set to avoid damage in areas with low ceiling heights 									
<b>Power tailgate (Sports Tourer models)</b>									
• Under-bumper release sensor • Tailgate close switch						○		316.67	<b>380.00</b>
• Maximum opening height can be set to avoid damage in areas with low ceiling heights 									
<b>Roof rails (Sports Tourer / Country Tourer models)</b>	●								
• Black		●	●	●	●	●	●		
• Silver-effect									
<b>Towing Pack</b>	○	○	○	○	○		○	570.83	<b>685.00</b>
• Retractable tow bar • Trailer stability programme integrated into ESP system									











● = Standard equipment. ○ = Optional at extra cost. N/C = No-cost option. □ = Available as part of an extra-cost option pack.

# INSIGNIA FEATURES / OPTIONS

<b>EXTERIOR STYLING</b>	Design / Design Nav	SRI / SRI Nav	SRI VX-Line Nav	Tech Line Nav	Elite Nav	GSi Nav	Country Tourer	Price (£) exc. VAT	Total (£) inc. VAT
<b>Body styling</b>	●	●	●	●	●	●	●		
• Chrome-effect front grille bar • Body-colour door mirrors	●	●	●	●	●	●	●		
• Chrome-effect upper window trim (excluding Design Grand Sport models)	●	●	●	●	●	●	●		
• Body-colour door handles	●	●	●	●	●	●	●		
• Rear spoiler (Grand Sport models)		●	●						
• Matt black B-pillars	●								
• Gloss black B-pillars		●	●	●	●	●	●		
• Matt black lower window trim	●	●	●						
• Gloss black lower window trim				●	●	●	●		
• GSi front and rear bumpers and side sills						●			
• GSi rear spoiler (Grand Sport models)						●			
• Dual visible exhaust tailpipes (Grand Sport 1.6 (200PS) Turbo and 2.0 (210PS) BiTurbo D models) – not available on 1.5 (165PS) Petrol, 1.6 (110/136PS) and 2.0 (170PS) Diesel Grand Sport Models)			●		●				
• Dual integrated exhaust tailpipes						●			
• Dual imitation exhaust bezels (Sports Tourer 1.6 (200PS) Turbo and 2.0 (210PS) BiTurbo D models) – not available on 1.5 (165PS) Petrol, 1.6 (110/136PS) and 2.0 (170PS) Diesel Sports Tourer models)		□	●	□	●		●		
• Anthracite wheel arch and side sill extensions							●		
• Front and rear bumpers incorporating silver-effect skid plates							●		
<b>VX-Line Styling Pack (not available on 1.6 Turbo D (110PS) ecoTEC models or with Aegean Blue solid paint)</b>									
• Sports-style front and rear bumpers • Side sills • Rear spoiler (Grand Sport models)		○	●	○	○			708.33	850.00
• Dual imitation exhaust bezels (Sports Tourer models) – not available on 1.5 (165PS) Petrol, 1.6 (110/136PS) and 2.0 (170PS) Diesel models)									
<b>Tech Line Nav Plus Pack (not available on 1.6 diesel ecoTEC models)</b>									
• 18-inch technical grey diamond-cut alloy wheels • 245/45 R 18 tyres • Front fog lights				○				416.67	500.00

● = Standard equipment. ○ = Optional at extra cost. □ = Available as part of an extra-cost option pack.

# INSIGNIA FEATURES / OPTIONS



<b>EXTERIOR COLOURS</b>		Design / Design Nav	SRi / SRi Nav	SRi VX-Line Nav	Tech Line Nav	Elite Nav	GSi Nav	Country Tourer	Price (£) exc. VAT	Total (£) inc. VAT
	<b>Aegean Blue</b> • Solid paint • Not available on Grand Sport SRi/SRi Nav models	●	●		●	●		●		
	<b>Summit White</b> • Brilliant paint • Standard colour on Grand Sport SRi/SRi Nav models	○	●	●	○	○	●	○	237.50	285.00
	<b>Lava Red</b> • Brilliant paint	○	○	○	○	○	○	○	237.50	285.00
	<b>Satin Steel Grey</b> • Two-coat metallic paint • Not available on GSi Nav models									
	<b>Sovereign Silver</b> • Two-coat metallic paint									
	<b>Mineral Black</b> • Two-coat metallic paint	○	○	○	○	○	○	○	504.17	605.00
	<b>Cosmic Grey</b> • Two-coat pearlescent paint									
	<b>Darkmoon Blue</b> • Two-coat premium paint	○	○	○	○	○		○	545.83	655.00
	<b>Rioja Red</b> • Two-coat premium paint									
	<b>Abalone White</b> • Tri-coat premium paint	○	○	○	○	○	○	○	729.17	875.00

● = Standard equipment. ○ = Optional at extra cost.

The colours reproduced may vary slightly from the actual paint colour. As a result they should be used as a guide only. Your Vauxhall Retailer has a comprehensive display of our paint samples.







# INSIGNIA FEATURES / OPTIONS

<b>WHEELS AND TYRES</b>		Design / Design Nav	SRI / SRI Nav	SRI VX-Line Nav	Tech Line Nav	Elite Nav	GSi Nav	Country Tourer	Price (£) exc. VAT	Total (£) inc. VAT
<b>Steel emergency spare wheel offer – 16-inch / 17-inch</b>										
1.5 (140PS) Turbo (Grand Sport / Sports Tourer 16-inch)		○								
1.5 (165PS) Turbo / 1.5 (165PS) Turbo auto (Grand Sport 16-inch / Sports Tourer 17-inch)		○	○	○	○	○				
1.6 (200PS) Turbo D auto (Grand Sport / Sports Tourer 17-inch)				○		○				
1.6 (110PS) Turbo D ecoTEC (Grand Sport / Sports Tourer 16-inch)		○	○		○	○			91.67	110.00
1.6 (136PS) Turbo D (Grand Sport 16-inch / Sports Tourer 17-inch)		○	○	○	○	○				
1.6 (136PS) Turbo D auto (Grand Sport / Sports Tourer 16-inch)		○	○	○	○	○				
2.0 (170PS) Turbo D BlueInjection manual / auto (Grand Sport / Sports Tourer / Country Tourer 17-inch)		○	○	○	○	○		○		
2.0 (170PS) Turbo D 4X4 BlueInjection (Country Tourer 17-inch)								○		
	<b>17-inch bi-colour structure wheels</b> <ul style="list-style-type: none"> <li>• 215/55 R 17 ultra-low rolling resistance tyres (1.6 diesel engines)</li> <li>• Emergency tyre inflation kit (in lieu of spare wheel)</li> </ul>	●								
	<b>17-inch five twin-spoke alloy wheels</b> <ul style="list-style-type: none"> <li>• 215/55 R 17 ultra-low rolling resistance tyres (1.6 diesel engines)</li> <li>• 225/55 R 17 tyres (excluding 1.6 diesel engines)</li> <li>• Emergency tyre inflation kit (in lieu of spare wheel)</li> </ul>		●		●					
	• All models excluding 1.6 diesel	●								
	• 1.6 diesel manual models only. Not available with other models			●		●				

● = Standard equipment. ○ = Optional at extra cost.

# INSIGNIA FEATURES / OPTIONS

<b>WHEELS AND TYRES</b>		Design / Design Nav	SRI / SRI Nav	SRI VX-Line Nav	Tech Line Nav	Elite Nav	GSi Nav	Country Tourer	Price (£) exc. VAT	Total (£) inc. VAT
			<b>18-inch five-spoke alloy wheels</b> <ul style="list-style-type: none"> <li>• 245/45 R 18 tyres (ultra-low rolling resistance tyres on 1.6 diesel auto)</li> <li>• Emergency tyre inflation kit (in lieu of spare wheel)</li> <li>• Not available on 1.6 diesel manual models</li> </ul>			●				
	<b>18-inch multi-spoke bi-colour technical grey diamond-cut alloy wheels</b> <ul style="list-style-type: none"> <li>• 245/55 R 18 (ultra-low rolling resistance tyres on 1.6 diesel auto)</li> <li>• Emergency tyre inflation kit (in lieu of spare wheel)</li> <li>• Not available on 1.6 diesel manual models</li> <li>• Available as part of Plus Pack on Tech Line Nav models</li> </ul>		○		○	●			420.83	505.00
	<b>18-inch five twin-spoke bi-colour technical grey alloy wheels</b> <ul style="list-style-type: none"> <li>• 235/50 R 18 tyres</li> <li>• Emergency tyre inflation kit (in lieu of spare wheel)</li> </ul>							●		
	<b>20-inch five twin-spoke bi-colour high gloss black alloy wheels</b> <ul style="list-style-type: none"> <li>• 245/35 R 20 tyres</li> <li>• Emergency tyre inflation kit (in lieu of spare wheel)</li> <li>• Only available as an option on 2.0 (170PS) Turbo D models</li> </ul>		○		○				829.17	995.00
				○		○				733.33
	<ul style="list-style-type: none"> <li>• Standard on 1.6 (200PS) Turbo and 2.0 (210PS) BiTurbo D models</li> </ul>			●		●				
	<b>20-inch bi-colour five twin-spoke alloy wheels</b> <ul style="list-style-type: none"> <li>• 245/35 R 20 Michelin Pilot Sport 4S tyres</li> <li>• Emergency tyre inflation kit (in lieu of spare wheel)</li> </ul>							●		

● = Standard equipment. ○ = Optional at extra cost.

# INSIGNIA SPECIFICATIONS

## PETROL ENGINES

	<b>1.5 (140PS) Turbo with Start/Stop</b>	<b>1.5 (165PS) Turbo with Start/Stop</b>	<b>1.6i Turbo (200PS) with Start/Stop</b>
Capacity	1490cc	1490cc	1598cc
Maximum power	140PS (103kW) @ 5600rpm	165PS (121kW) @ 5600rpm	200PS (147kW) @ 4700-5500rpm
Maximum torque	250Nm (184 lb.ft.) @ 2000-4100rpm	250Nm (184 lb.ft.) @ 2000-4500rpm	300Nm (221 lb.ft.) @ 1700-4700rpm
Configuration	4 cylinders, 4 valves per cylinder, double overhead camshafts	4 cylinders, 4 valves per cylinder, double overhead camshafts	4 cylinders, 4 valves per cylinder, double overhead camshafts
Fuel/induction system	Turbocharger with intercooler. Variable Valve Timing (VVT). Direct fuel injection	Turbocharger with intercooler. Variable Valve Timing (VVT), Direct fuel injection	Water-cooled turbocharger with intercooler. Variable Valve Timing (VVT). Central direct fuel injection
Emission compliance	Euro 6d-TEMP (6.2). Petrol Particulate Filter	Euro 6d-TEMP (6.2). Petrol Particulate Filter	Euro 6d-TEMP (6.2). Petrol Particulate Filter
Service interval	20,000 miles or 1 year (whichever occurs sooner)	20,000 miles or 1 year (whichever occurs sooner)	20,000 miles or 1 year (whichever occurs sooner)

## DIESEL ENGINES

	<b>1.6 (110PS) Turbo D ecoTEC with Start/Stop</b>	<b>1.6 (136PS) Turbo D with Start/Stop</b>
Capacity	1598cc	1598cc
Maximum power	110PS (81kW) @ 4000rpm	136PS (100kW) @ 3500-4000rpm
Maximum torque	300Nm (221 lb.ft.) @ 2000rpm	320Nm (236 lb.ft.) @ 2000-2250rpm
Configuration	4 cylinders, 4 valves per cylinder, double overhead camshafts	4 cylinders, 4 valves per cylinder, double overhead camshafts
Fuel/induction system	Turbocharger with intercooler. Common rail fuel injection	Variable geometry turbocharger with intercooler. Common rail fuel injection
Emission compliance	Euro 6d-TEMP (6.2). Diesel Particulate Filter	Euro 6d-TEMP (6.2). Diesel Particulate Filter
Service interval	20,000 miles or 1 year (whichever occurs sooner)	20,000 miles or 1 year (whichever occurs sooner)

	<b>2.0 (170PS) Turbo D with Start/Stop</b>	<b>2.0 (210PS) BiTurbo D with Start/Stop</b>
Capacity	1956cc	1956cc
Maximum power	170PS (125kW) @ 3750rpm	210PS (154kW) @ 4000rpm
Maximum torque	400Nm (295 lb.ft.) @ 1750-2500rpm	480Nm (354 lb.ft.) @ 1500rpm
Configuration	4 cylinders, 4 valves per cylinder, double overhead camshafts	4 cylinders, 4 valves per cylinder, double overhead camshafts
Fuel/induction system	Variable geometry turbocharger with intercooler. Common rail fuel injection	Two stage turbocharger with intercooler. Common rail fuel injection
Emission compliance	Euro 6d-TEMP (6.2). Diesel Particulate Filter	Euro 6d-TEMP (6.2). Diesel Particulate Filter
Service interval	20,000 miles or 1 year (whichever occurs sooner)	20,000 miles or 1 year (whichever occurs sooner)

# INSIGNIA SPECIFICATIONS

## GRAND SPORT PERFORMANCE, FUEL ECONOMY AND EMISSIONS

	Wheel size (inches)	Performance (manufacturer's figures)		Fuel economy mpg (litres/100km)#		CO <sub>2</sub> emissions g/km*	Vehicle Excise Duty**		Benefit in kind company car taxation rates – 2018/19 tax year
		Maximum speed (mph)	Acceleration 0-60mph (sec)	Combined Low	Combined High		First year rate	Standard rate	
<b>Manual</b>									
1.5 (140PS) Turbo	17/18	130	9.3	40.9 (6.9)	45.6 (6.2)	129	£165	£140	26%
1.5 (165PS) Turbo	17/18	138	8.4	40.4 (7.0)	44.8 (6.3)	129	£165	£140	26%
1.6 (200PS) Turbo	20	146	7.2	39.2 (7.2)	42.2 (6.7)	145	£205	£140	30%
1.6 (110PS) Turbo D ecoTEC (with ULRR tyres)	17	127	11.1	54.3 (5.2)	57.7 (4.9)	116	£205	£140	28%
1.6 (136PS) Turbo D (with ULRR tyres)	17	131	9.9	49.6 (5.7)	54.3 (5.2)	121	£205	£140	29%
2.0 (170PS) Turbo D	17/18	140	8.2	47.1 (6.0)	51.4 (5.5)	141	£515	£140	33%
2.0 (170PS) Turbo D	20	140	8.2	47.1 (6.0)	51.4 (5.5)	144	£515	£140	33%
<b>Automatic</b>									
1.5 (165PS) Turbo	17/18	135	8.8	37.7 (7.5)	40.9 (6.9)	138	£205	£140	28%
1.6 (200PS) Turbo	20	144	7.5	36.7 (7.7)	39.2 (7.2)	153	£515	£140	31%
1.6 (136PS) Turbo D (with ULRR tyres)	17/18	127	10.2	44.8 (6.3)	48.7 (5.8)	137	£515	£140	32%
2.0 (170PS) Turbo D	17/18	139	8.4	42.8 (6.6)	46.3 (6.1)	146	£515	£140	34%
2.0 (170PS) Turbo D	20	139	8.4	42.8 (6.6)	46.3 (6.1)	147	£515	£140	34%
2.0 (210PS) BiTurbo D 4X4 (exc. GSi Nav)	20	145	7.4	36.2 (7.8)	39.2 (7.2)	184	£1240	£140	37%
2.0 (210PS) BiTurbo D 4X4 GSi Nav	20	145	7.4	36.7 (7.7)	37.2 (7.6)	187	£1240	£140	37%

ULRR = Ultra-low rolling resistance.

# = Fuel consumption figures are determined according to the WLTP test cycle. Full data relating to WLTP test cycles can be found at: [www.vauxhall.co.uk/wltp](http://www.vauxhall.co.uk/wltp)

\*CO<sub>2</sub> emissions figures are determined according to the WLTP test cycle however, a Government formula is then applied to translate these figures back to what they would have been under the outgoing NEDC test cycle, which WLTP replaces. The correct tax treatment is then applied.

Figures are intended for comparability purposes only. The fuel consumption you achieve under real life driving conditions and CO<sub>2</sub> produced will depend upon a number of factors, including the accessories fitted after registration, variations in driving styles, weather conditions and vehicle load. Only compare fuel consumption and CO<sub>2</sub> with other vehicles tested using the same technical procedures. For more information contact your local Vauxhall Retailer.

\*\* = Correct at time of publication.

# INSIGNIA SPECIFICATIONS

## SPORTS TOURER PERFORMANCE, FUEL ECONOMY AND EMISSIONS

	Wheel size (inches)	Performance (manufacturer's figures)		Fuel economy mpg (litres/100km)#		CO <sub>2</sub> emissions g/km*	Vehicle Excise Duty**		Benefit in kind company car taxation rates – 2018/19 tax year
		Maximum speed (mph)	Acceleration 0-60mph (sec)	Combined Low	Combined High		First year rate	Standard rate	
<b>Manual</b>									
1.5 (140PS) Turbo	17/18	129	9.6	39.2 (7.2)	43.5 (6.5)	131	£205	£140	27%
1.5 (165PS) Turbo	17/18	135	8.6	39.2 (7.2)	43.5 (6.5)	131	£205	£140	27%
1.6 (200PS) Turbo	20	144	7.4	38.2 (7.4)	41.5 (6.8)	151	£515	£140	31%
1.6 (110PS) Turbo D ecoTEC (with ULRR tyres)	17	126	10.9	52.3 (5.4)	55.4 (5.1)	121	£205	£140	29%
1.6 (136PS) Turbo D (with ULRR tyres)	17	129	10.1	47.9 (5.9)	52.3 (5.4)	125	£205	£140	30%
2.0 (170PS) Turbo D	17/18	139	8.4	45.6 (6.2)	50.4 (5.6)	145	£515	£140	34%
2.0 (170PS) Turbo D	20	139	8.4	45.6 (6.2)	50.4 (5.6)	148	£515	£140	34%
<b>Automatic</b>									
1.5 (165PS) Turbo	17/18	133	9.0	36.2 (7.8)	39.8 (7.1)	144	£205	£140	29%
1.6 (200PS) Turbo	20	143	7.7	35.8 (7.9)	38.7 (7.3)	154	£515	£140	31%
1.6 (136PS) Turbo D (with ULRR tyres)	17/18	126	10.5	44.1 (6.4)	47.9 (5.9)	139	£515	£140	32%
2.0 (170PS) Turbo D	17/18	137	8.6	41.5 (6.8)	45.6 (6.2)	148	£515	£140	34%
2.0 (170PS) Turbo D	20	137	8.6	41.5 (6.8)	45.6 (6.2)	150	£515	£140	35%
2.0 (210PS) BiTurbo D 4X4 (exc. GSi Nav)	20	144	7.5	35.8 (7.9)	38.7 (7.3)	187	£1240	£140	37%
2.0 (210PS) BiTurbo D 4X4 GSi Nav	20	144	7.5	35.3 (8.0)	36.7 (7.7)	188	£1240	£140	37%

## COUNTRY TOURER PERFORMANCE, FUEL ECONOMY AND EMISSIONS

	Wheel size (inches)	Performance (manufacturer's figures)		Fuel economy mpg (litres/100km)#		CO <sub>2</sub> emissions g/km*	Vehicle Excise Duty**		Benefit in kind company car taxation rates – 2018/19 tax year
		Maximum speed (mph)	Acceleration 0-60mph (sec)	Combined Low	Combined High		First year rate	Standard rate	
<b>Manual</b>									
2.0 (170PS) Turbo D	18	137	8.6	44.8 (6.3)	47.1 (6.0)	150	£515	£140	35%
2.0 (170PS) Turbo D 4X4	18	135	9.3	40.9 (6.9)	42.2 (6.7)	164	£830	£140	37%
<b>Automatic</b>									
2.0 (170PS) Turbo D	18	135	8.8	41.5 (6.8)	43.5 (6.5)	151	£830	£140	35%
2.0 (210PS) BiTurbo D 4X4	18	142	7.7	35.3 (8.0)	36.7 (7.7)	188	£1240	£140	37%

ULRR = Ultra-low rolling resistance.

# = Fuel consumption figures are determined according to the WLTP test cycle. Full data relating to WLTP test cycles can be found at: [www.vauxhall.co.uk/wltp](http://www.vauxhall.co.uk/wltp)

\*CO<sub>2</sub> emissions figures are determined according to the WLTP test cycle however, a Government formula is then applied to translate these figures back to what they would have been under the outgoing NEDC test cycle, which WLTP replaces. The correct tax treatment is then applied.

Figures are intended for comparability purposes only. The fuel consumption you achieve under real life driving conditions and CO<sub>2</sub> produced will depend upon a number of factors, including the accessories fitted after registration, variations in driving styles, weather conditions and vehicle load. Only compare fuel consumption and CO<sub>2</sub> with other vehicles tested using the same technical procedures. For more information contact your local Vauxhall Retailer.

\*\* = Correct at time of publication.

# INSIGNIA SPECIFICATIONS

## TRANSMISSION

### Six-speed manual gearbox

Petrol engines: 1.5 (140PS) Turbo, 1.5 (165PS) Turbo and 1.6 (200PS) Turbo models  
 Diesel engines: 1.6 (110/136PS) Turbo D and 2.0 (170PS) Turbo D models

### Automatic transmission with ActiveSelect®

Six-speed automatic transmission: Optional at extra cost on 1.5 (165PS) Turbo / 1.6 (200PS) Turbo / 1.6 (136PS) Turbo D models.

Eight-speed automatic transmission: Standard on 2.0 (210PS) BiTurbo D 4X4, optional at extra cost on 2.0 (170PS) Turbo D front-wheel drive models.

The latest generation automatic transmissions available on Insignia, incorporating Start/Stop technology, offer improved fuel economy and refinement over previous versions. On the road, a wide selection of shift patterns is adapted to the style and habits of the driver, anticipating when maximum acceleration or maximum efficiency is required. The electronic control will also adapt to the prevailing road conditions, reducing gear shifting when climbing or descending and using engine braking assistance during down changes.

The ActiveSelect® manual mode allows the gear lever to be used like a sequential manual gearbox – you simply push the lever forward or back to change up or down the gears. The eight-speed transmission includes a range of driver-selectable modes.

### Four-wheel drive system

Standard on Elite Nav 2.0 (210PS) BiTurbo D 4X4, GSi Nav and Country Tourer 4X4 models. The sophisticated four-wheel drive system replaces the conventional rear axle differential with two electronically controlled clutches which allows Insignia to take advantage of the latest torque vectoring technology. This ensures that torque is directed to the wheels with the greatest grip, thus improving handling in all conditions and traction in slippery conditions.

## FUEL TANK CAPACITY

62 litres (13.6 gallons)

## ADBLUE TANK CAPACITY

15 litres (3.3 gallons)

## INSURANCE GROUPS

	Design/ Design Nav	SRi/ SRi Nav	SRi VX-Line Nav	Tech Line Nav	Elite Nav	GSi	Country Tourer
1.5 (140PS) Turbo	14E	–	–	–	–	–	–
1.5 (165PS) Turbo	16E	17E	17E	17E	17E	–	–
1.6 (200PS) Turbo	–	–	25E	–	25E	–	–
1.6 (110PS) Turbo D	13E	14E	–	14E	16E	–	–
1.6 (136PS) Turbo D	15E/16E	16E	16E	16E	18E	–	–
2.0 (170PS) Turbo D	20E	20E	21E	21E	23E	–	20E
2.0 (210PS) BiTurbo D	–	–	–	–	27E	28E	24E

# INSIGNIA SPECIFICATIONS

## WEIGHTS AND TOWING DATA kg

	Gross vehicle weight			Maximum towing weights Trailer with brakes (without brakes)		
	Grand Sport	Sports Tourer	Country Tourer	Grand Sport	Sports Tourer	Country Tourer
1.5 (140PS) Turbo	2015	2080	–	1405 (700)	1405 (730)	–
1.5 (165PS) Turbo	2015	2085	–	1405 (700)	1405 (730)	–
1.5 (165PS) Turbo automatic	2040	2110	–	1405 (700)	1405 (730)	–
1.6 (200PS) Turbo	2090	2130	–	1410 (730)	1410 (750)	–
1.6 (200PS) Turbo automatic	2110	2165	–	1410 (730)	1410 (750)	–
1.6 (110PS) Turbo D ecoTEC	2035	2125	–	1405 (720)	1405 (750)	–
1.6 (136PS) Turbo D	2070	2140	–	1405 (730)	1405 (750)	–
1.6 (136PS) Turbo D automatic (inc. Sports Tourer)	2095	2165	–	1300 (730)	1300 (750)	–
2.0 (170PS) Turbo D	2185	2240	2240	1950 (750)	1950 (750)	1950 (750)
2.0 (170PS) Turbo D automatic	2220	2270	2270	1700 (750)	1700 (750)	1700 (750)
2.0 (170PS) Turbo D 4X4	–	–	2330	–	–	2200 (750)
2.0 (210PS) BiTurbo D 4X4	2340	2390	2380	1805 (750)	1805 (750)	1805 (750)

Gross vehicle weight is the total permissible weight of the vehicle including passengers and their luggage. The maximum roof rack loading should not exceed 100kg on all models. The maximum towing weights are based on the ability of the car, with two occupants of 75kg each, to restart on a 12% gradient, which is approximately 1 in 8.3, at sea level. The permitted trailer load applies up to the specified incline and up to an altitude of 1000 metres above sea level. The permissible gross train weight decreases by 10% for every 1000 metres of additional altitude. Any extra weight, such as luggage or additional passengers, should be deducted from the maximum towing weight. With a trailer fully loaded, maximum noseweight should not exceed 60kg (75kg on Sports Tourer models, 90kg on 2.0 (170PS) Turbo D and 2.0 (210PS) BiTurbo 4x4 models). Always fit Vauxhall towing attachments and accessories available from your Vauxhall Retailer. They are designed specifically for Vauxhall models and carry a 12-month guarantee. During trailer towing do not exceed a maximum speed of 60mph. This speed limit is also applicable in countries with higher permitted speeds for trailer-vehicle combinations. Pay attention to the local speed limits. For trailers with low driving stability and caravans the use of an oscillation damper is strongly recommended.

## SUSPENSION

**Front:** Independent. Lightweight MacPherson struts with gas-pressure dampers and coil springs. Anti-roll bar.

**Rear:** Lightweight multi-link (FWD - 4-link; 4X4 – 5-link) with rising-rate mini-block coil springs and gas-pressure dampers. Anti-roll bar.

• GSi Nav models feature an uprated sports chassis with lower ride height and specially tuned dampers

### FlexRide (Adaptive Stability Technology) system

FlexRide offers drivers the choice of three distinct driving modes – Normal (default setting), Sport or Tour. GSi Nav models include a fourth, unique, Competition mode.

- Sport mode: This stiffens the car's suspension and sharpens steering and throttle responses. It also raises the threshold at which the ESP and traction control systems are activated, enhancing dynamic performance
- Tour mode: Ideal for long motorway journeys, the Tour mode adjusts the dampers to a softer setting to create a perceptibly smoother ride and further enhance Insignia's ride comfort
- Continuous damping control: Utilises data from up to 11 variables including acceleration, braking and cornering to constantly control the suspension for optimum stability, driver engagement and comfort. Operates in all three driving modes

## BODY

Aerodynamic drag co-efficient:  
Cd 0.26

## STEERING

- Speed-sensitive electric power-assisted steering
- Turning circle (kerb-to kerb):  
– 11.15m (36.6ft.)

## BRAKING AND STABILITY

- Electronic Stability Programme (ESP)
- Cornering brake control
- Straight line stability control
- Rollover mitigation
- Drag torque control
- Hill start assist
- Anti-lock Braking System (ABS)
- Emergency brake assist
- Fading brake support
- Electronic brakeforce distribution
- Adaptive brake lights

### 1.5 (140PS/165PS) Turbo

Front ventilated discs: 300mm diameter

Rear discs: 288mm diameter

### 1.6 (110PS) Turbo D

Front ventilated discs: 300mm diameter

Rear discs: 288mm diameter

### 1.6 (136PS) Turbo D

Front ventilated discs: 321mm diameter

Rear discs: 288mm diameter

### 1.6 (200PS) Turbo

Front ventilated discs: 300mm diameter

Rear discs: 288mm diameter

### 2.0 (170PS) Turbo D

Front ventilated discs: 321mm diameter

Rear ventilated discs: 315mm diameter

### 2.0 (170PS) Turbo D 4X4

Front ventilated discs: 321mm diameter

Rear ventilated discs: 315mm diameter

### 2.0 (210PS) BiTurbo D 4X4 (excluding GSi Nav)

Front ventilated discs: 321mm diameter

Rear ventilated discs: 315mm diameter

### 2.0 (210PS) BiTurbo D 4X4 GSi Nav

Front ventilated discs: 345mm diameter

Rear ventilated discs: 315mm diameter

# INSIGNIA SPECIFICATIONS

## EXTERIOR DIMENSIONS millimetres (inches)

### Grand Sport

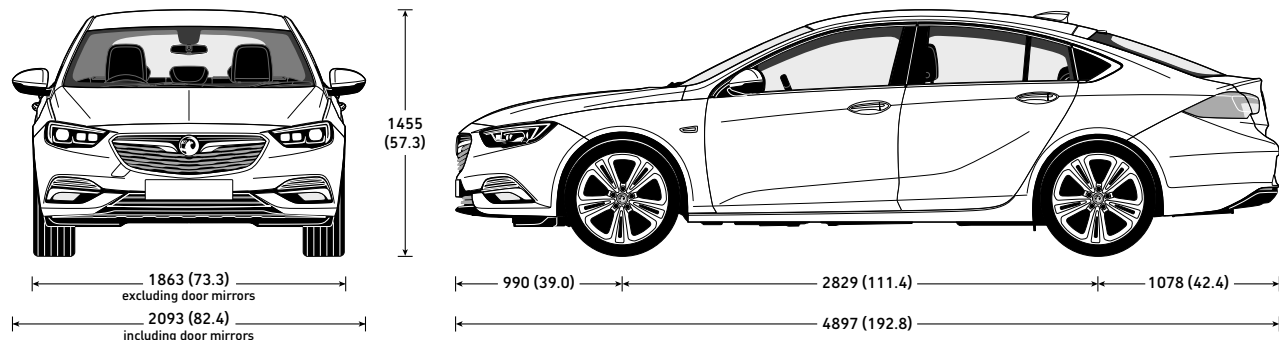

### Sports Tourer

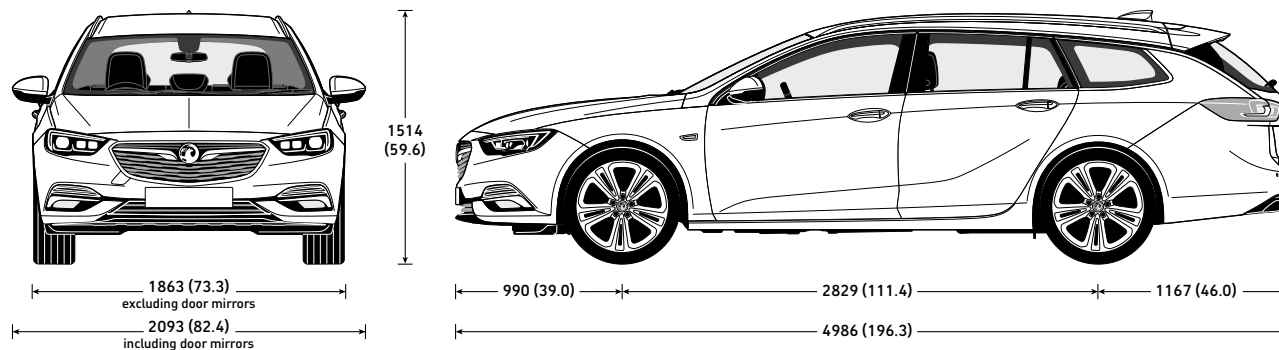

### Country Tourer

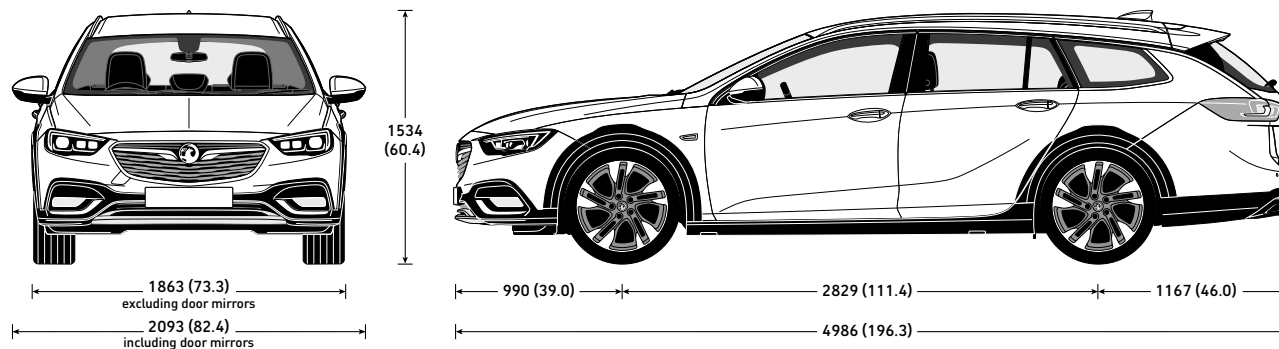

## LOADSPACE DIMENSIONS mm (inches)

	Grand Sport	Sports Tourer
Load floor length (rear seats folded)	1940 (76.4)	2005 (78.9)
Load floor length (behind rear seats)	1133 (44.6)	1178 (46.3)
Load area width	1030 (40.5)	1030 (40.5)
Load area height	722 (28.4)	794 (31.2)
Tailgate aperture height	557 (21.9)	711 (28.0)

## LOADSPACE CAPACITIES\* litres (cu.ft.)

	Grand Sport	Sports Tourer
Rear seat up (under luggage compartment cover)	490 (17.3)	560 (19.8)
Rear seat down (measured to roof)	1450 (51.1)	1665 (58.8)

\* = Measured using the ECIE method. When an optional spare wheel is specified loadspace capacity is reduced due to a raised luggage compartment floor.



# INSIGNIA ACCESSORIES

## Total (inc. VAT)

### CHILD SEATS<sup>1</sup>

BABY-SAFE <sup>2</sup> – 0-13kg/birth to 15 months	£132
– ISOFIX base	£240
DUO ISOFIX <sup>2</sup> – 9-18kg/9 months to 4 years with top tether kit	£367
KID <sup>2</sup> –15-36kg or 4 to 12 years	£166

1 = Restrictions apply to the use of child seats, please consult your Vauxhall Retailer or request a copy of the Child seats brochure.

2 = Without transponder.

### INTERIOR

Cupholder insert	
– Tissue	£17
– Notepad	£17
– Make-up	£17

### SAFETY

Parking sensors	
– four fully flush front bumper mounted sensors	£314
– four fully flush rear bumper mounted sensors	£332
Rear view camera	£272
Safety Pack – first aid kit, warning triangle, hi-visibility vest	£37
First aid kit	£15
Warning triangle	£18
Fire extinguisher – 2kg	£39
Hi-visibility vest	£9

## Total (inc. VAT)

### FLEXCONNECT RANGE

FlexConnect bracket	£21
FlexConnect hook	£31
FlexConnect coat hanger	£34
FlexConnect folding table	£76
FlexConnect iPad Mini cradle	£107
FlexConnect iPad (1-4) cradle	£116
FlexConnect iPad Air cradle	£115
FlexConnect Samsung Galaxy cradle	£105

### PRACTICAL

Spare bulb kit <sup>3</sup>	£39
Spare bulb kit (white) <sup>3</sup>	£38
Stretch tow rope – 3000kg	£35
Privacy Shades (rear and rear side windows)	
– Grand Sport	£94
– Sports Tourer	£108

3 = Excludes xenon headlight bulb for models with Adaptive Forward Lighting (AFL).

### PROTECTION

Rubber floor mats – set of four	£50
Velour floor mats – set of four	£54
Economy floor mats – set of four	£44
Cargo liner – reversible	£88
Cargo net - horizontal	
– Grand Sport	£45
– Sports Tourer	£50
Mudflaps	
– front	£51
– rear (Grand Sport)	£51
– rear (Sports Tourer) <sup>4</sup>	£46
Dog guard (Sports Tourer)	£191
Door mirror caps	
– Carbon	£128
– Aluminium	£229
Bumper load protection film	£97

4 = Excludes Country Tourer.

## Total (inc. VAT)

### TRANSPORT SYSTEMS

Roof base carrier	from £190
<b>Roof carriers (requires base carrier)</b>	
Bike roof carrier – Thule Freeride 532	£78
Surf board roof carrier – Thule 833	£82
Kayak roof carrier – Thule 837	£172
Ski roof carrier – up to 4 pairs (400mm wide) – Thule 7324	£161
Ski roof carrier – up to 6 pairs (600mm wide) – Thule 7326	£190
<b>Hard shell roof boxes (requires base carrier)</b>	
Thule Ocean 80 (320 litre / 1330 x 860 x 370mm)	£154
Thule Ocean 200 (450 litre / 1750 x 820 x 450mm)	£323
Thule Motion 800 (460 litre / 2050 x 840 x 450mm)	from £463
Thule Touring 200 (400 litre / 1750 x 820 x 450mm)	£338
Thule Touring 700 (430 litre / 2320 x 700 x 420mm)	£378

## Total (inc. VAT)

### Tow bar carrier system

Fixed tow bar	£472
Detachable tow bar	£564

### STYLING

Door sill plates	£39
Stainless steel pedal covers	
– manual	£126
– automatic	£148
Rear Spoiler (Grand Sport)	£262

### ALLOY WHEELS (set of four with centre caps)<sup>5</sup>

18-inch High Gloss Black	£1,306
--------------------------	--------

5 = Different tyres and locking wheel bolts/nuts may be required at extra cost. Price excludes new tyres and locking wheel bolts/nuts, includes static wheel balancing.

**Please note:**  
Prices shown are fully fitted and painted, where applicable and include VAT. Please check with your local Vauxhall Retailer for details. It is advisable to ensure your insurance policy is adequate to cover additional fitted accessories. Prices correct at time of publication.

# INSIGNIA COMPANY CAR DRIVER/FLEET INFORMATION

## DESIGN AND TECH LINE HIGH SPEC, LOW P11D

Specifically developed for businesses and company car drivers alike, our Design and Tech Line Nav models are seriously fit for Fleet.

Design models all feature very low P11D values, generous standard specification, including Sat Nav on Design Nav models, and a choice of high tech ecoTEC engines for great fuel economy and low emissions.

For even more standard specification, step up to our Tech Line Nav range. Again you are guaranteed low P11D values, plus great standard kit including Sat Nav, Bluetooth®, USB connection, aux-in socket and digital radio.

With Design and Tech Line Nav you can take for granted low Whole Life Costs and low company car driver taxation.



## COMPANY CAR DRIVER FREE\* 3 DAY TEST DRIVE

Our free\* 3 Day Test Drive programme is open to all Company Car Drivers. It allows you to choose most models in the current Vauxhall line-up (exclusions apply). With full insurance cover provided, it gives you a meaningful length of time to make an informed decision about your next company car.

Search Vauxhall 3DTD to book your FREE\* test drive or click the link the below:

[Vauxhall 3 Day Test Drive](#)

\*The free 3 Day Test Drive programme is open to Company Car Drivers and Fleet Decision Makers. Available for UK Mainland only. Terms and conditions apply. Full terms and conditions can be found at [vauxhallfleet.co.uk/testdrive/index/terms](#).

## BENEFIT IN KIND COMPANY CAR TAXATION†

The car benefit charge will be the car's list price (including VAT, options and accessories fitted, delivery to Retailer and number plates, but excluding Vehicle Excise Duty and new vehicle first registration fee) multiplied by the percentage charge for the CO<sub>2</sub> emissions band in which the car falls (see table opposite). Multiply this figure by your personal income tax rate (20%†† for Basic Rate, 40%†† for Higher Rate) to calculate your annual benefit in kind tax liability.

### Example:

Insignia Tech Line Nav 1.6 (110PS) Turbo D ecoTEC Grand Sport (CO <sub>2</sub> emissions 116g/km)	
On-the-road RRP	£23400.00
Deduct: Vehicle Excise Duty	(£205.00)
New vehicle first registration fee	(£55.00)
<b>Effective list price</b>	<b>£23140.00</b>
Add: Optional two-coat metallic paint	
	£605.00

List price for tax purposes (P11D value)	£23745.00
--	-----------

<b>Car benefit charge</b>	
2018-19 tax year (28%)	£6649.00

<b>Benefit in kind tax liability (2018-19 tax year)</b>	
Basic Rate (20%) tax payer	£1329.80
Higher Rate (40%) tax payer	£2659.60

† = Please note this Price Guide provides taxation information as a guide only. Vauxhall does not provide taxation guidance. Drivers should always take professional advice on their own tax position. †† = Excludes residents of Scotland.

### BIK FOR SCOTTISH RESIDENTS

Effective 6 April 2018 the Scottish Government have introduced their own BIK taxation structure. This only applies to Company Car Drivers that are Scottish taxpayers. HMRC will determine whether or not an individual is a Scottish taxpayer based on where their main place of residence is.

The BIK rates for Scotland are:

- Over £11,850-£13,850 Starter Rate 19%
- Over £13,850-£24,000 Basic Rate 20%
- Over £24,000-£43,430 Intermediate Rate 21%
- Over £43,430-£150,000 Higher Rate 41%
- Above £150,000 Top Rate 46%

CO <sub>2</sub> emissions in grams per kilometre	Percentage of car's price to be taxed	
	Non-Diesel† 2018-19 tax year	Diesel†† 2018-19 tax year
Up to 50	13	17
51-75	16	20
76-94	19	23
95-99	20	24
100-104	21	25
105-109	22	26
110-114	23	27
115-119	24	28
120-124	25	29
125-129	26	30
130-134	27	31
135-139	28	32
140-144	29	33
145-149	30	34
150-154	31	35
155-159	32	36
160-164	33	37
165-169	34	37
170-174	35	37
175-179	36	37
180 and above	37	37

† = Also applies to diesel vehicles that meet the Real Driving Emissions Step 2 (RDE2). †† = Applies to vehicles that do not meet the Real Driving Emissions Step 2 (RDE2).

To calculate your own personal liability, search: [Vauxhall BiK](#), or click the link below: [Vauxhall BiK Tool](#)

## FLEET TOOLBOX



Discover the facts in our online Toolbox for both Company Car Drivers and Fleet Decision Makers. The Fleet Toolbox has a host of useful calculators, comparators, interactive listings and information.

Search Vauxhall Fleet Tools or click the link below: [Vauxhall Fleet Tool Box](#)

## CONTACT VAUXHALL FLEET

Please contact one of our dedicated sales teams who will be happy to help with your particular enquiry.

### Company Car Drivers

Call: 0345 111 2020

Email: [company-car@vauxhallinfo.co.uk](mailto:company-car@vauxhallinfo.co.uk)

Telephone lines are open

– Monday to Friday 8.00am-9.00pm

– Saturday and Sunday 9.00am-6.00pm

### Fleet Decision Makers

Depending on the size of your fleet of vehicles, we have a dedicated team to handle your enquiries.

The lines are open Monday to Friday excluding Bank Holidays.

### 1-24 vehicles

Call: 0845 076 2254 (8.30am-5.00pm)

### 25+ vehicles

Call: 0330 587 8222 (8.30am-5.00pm)

Email: [vauxhallfleet@vauxhall.co.uk](mailto:vauxhallfleet@vauxhall.co.uk)

### Special Vehicles (Police, Fire and Ambulance)

Call: 01582 409999 (8.30am-5.00pm)

Email: [vauxhallspecialvehicles@vauxhall.co.uk](mailto:vauxhallspecialvehicles@vauxhall.co.uk)

# INSIGNIA ADDITIONAL INFORMATION

## ON-THE-ROAD PRICES

To eliminate uncertainty about hidden costs when buying a new car, Vauxhall publishes on-the-road recommended retail prices (RRP) and these are shown in the pricing tables within this price guide. These prices include VAT, number plates and delivery to Retailer of £700.00 (including £116.67 VAT), 12 months' Government Vehicle Excise Duty (see opposite for details) and the DVLA new vehicle first registration fee of £55.00\*.

**Please note:** The on-the-road recommended retail price (RRP) does not include fuel supplied by the Retailer, motor insurance or any other goods or services supplied by agreement between the Retailer and the customer.

## PRICE PROTECTION

Order a new Vauxhall for build in the current model year (as confirmed by your Retailer) for delivery no more than three months in advance and the price you are quoted is the price you pay. This is irrespective of any subsequent price rises between placing your order and delivery of your new car, but you must take delivery as soon as the car is available. Vauxhall Motors Limited is not liable for price adjustments caused by Government changes in the rate of VAT (currently 20%), Vehicle Excise Duty, DVLA new vehicle first registration fee or by any other applicable legislation or regulations.

## VAUXHALL FINANCE LEASING

Vauxhall Finance Leasing is a trading style of Vauxhall Finance plc. Working with the Vauxhall Retailer network we provide competitive car and van leasing solutions for business users and private individuals. We combine the support of a national contract with the convenience of a local contact. For further information, please contact your local Vauxhall Retailer or visit [www.vauxhall.co.uk/leasing](http://www.vauxhall.co.uk/leasing)

## IN THE EVENT OF AN ACCIDENT...

Vauxhall Accident Management helps keep you mobile following an accident. Benefits include vehicle recovery, Vauxhall-approved repairs and contacting your insurer. For more details, visit [vauxhall.co.uk/AccidentManagement](http://vauxhall.co.uk/AccidentManagement)

## VEHICLE EXCISE DUTY

The amount of Vehicle Excise Duty (road fund licence) payable on new cars varies depending on the level of carbon dioxide (CO<sub>2</sub>) emissions produced by the vehicle. CO<sub>2</sub> emissions are measured in grammes (g) per kilometre (km) travelled and divided into 13 charging bands shown in the table below.

A 'first year rate' of Vehicle Excise Duty is payable on all new cars and in subsequent years the amount payable reverts to the 'standard rate'. From 1 April 2017 the breakpoints for each of these bands have been revised. Also, for vehicles with a list price over £40,000, including factory-fitted options, an additional £310 is payable for the first five years of standard rate payments.

## VEHICLE EXCISE DUTY\*

	CO <sub>2</sub> emissions	First year rate		Standard rate
		Non-diesel**	Diesel†	
<b>Band A</b>	0g/km	£0.00	£0.00	£0.00
<b>Band B</b>	1 – 50g/km	£10.00	£25.00	£140.00
<b>Band C</b>	51 – 75g/km	£25.00	£105.00	£140.00
<b>Band D</b>	76 – 90g/km	£105.00	£125.00	£140.00
<b>Band E</b>	91 – 100g/km	£125.00	£145.00	£140.00
<b>Band F</b>	101 – 110g/km	£145.00	£165.00	£140.00
<b>Band G</b>	111 – 130g/km	£165.00	£205.00	£140.00
<b>Band H</b>	131 – 150g/km	£205.00	£515.00	£140.00
<b>Band I</b>	151 – 170g/km	£515.00	£830.00	£140.00
<b>Band J</b>	171 – 190g/km	£830.00	£1,240.00	£140.00
<b>Band K</b>	191 – 225g/km	£1,240.00	£1,760.00	£140.00
<b>Band L</b>	226 – 255g/km	£1,760.00	£2,070.00	£140.00
<b>Band M</b>	over 255g/km	£2,070.00	£2,070.00	£140.00

\* = Correct at time of issue. \*\* = Also applies to diesel vehicles that meet the Real Driving Emissions Step 2 (RDE2).

† = Applies to vehicles that do not meet the Real Driving Emissions Step 2 (RDE2).

# TRUST VAUXHALL

## CUSTOMER CARE COMMITMENT

For added peace of mind, Vauxhall has an innovative Customer Care Commitment that offers the following:

- Three-year vehicle warranty consisting of a one-year/unlimited mileage manufacturer's warranty and a second and third year manufacturer's warranty with a 60,000 miles limitation
- Vauxhall Assistance for 12 months from first registration
- Six years' body panel anti-perforation warranty

Please note: Warranty is only available on vehicles sourced from Vauxhall Motors Limited. Terms and conditions apply – please see your Vauxhall Retailer for details.

## VAUXHALL ASSISTANCE

Vauxhall Assistance is provided automatically with every new Vauxhall for 12 months from first registration and covers everything from accident assistance, roadside recovery and 'at home' service to flat tyres. With Vauxhall Assistance help is literally just a free\* phone call away, 24 hours a day, 365 days a year!

\* = Mobile phone users will be charged at their standard tariff.

## PROTECTING THE ENVIRONMENT

Vauxhall's commitment to the environment is demonstrated by our products' many environmental awards. For even more information on Vauxhall's efforts to achieve an environmentally sustainable future, and how to dispose of your end-of-life vehicle, see [www.vauxhall.co.uk/recycling](http://www.vauxhall.co.uk/recycling)

## VAUXHALL SERVICE PLAN

- Fixed monthly payments for the plan duration
- Easy to budget and interest-free
- Genuine parts fitted by Vauxhall-trained technicians

### Plus on Gold plans:

- Valet and courtesy car
- Vauxhall Roadside Assistance
- Engine flush and fuel treatments
- Litre of oil for top ups between services

Full details can be obtained from your local participating Vauxhall Retailer.

## VAUXHALL INSURANCE WITH ADDED REASSURANCE

Comprehensive cover – Summary of benefits\*\*

- Competitive premiums
- Repairs by a Vauxhall-trained technician
- Genuine Vauxhall parts, guaranteed for three years when we repair your car within our Approved Repairer Network
- Free courtesy car as standard when using an Approved Repairer†
- 24 hour claims helpline
- Personal Accident benefit
- Cover for audio equipment
- Windscreen cover

## Call for a quote on 0844 463 2670††

\*\* = The benefits listed above are for comprehensive cover only. For details of Third Party, Fire and Theft cover, please call our sales team.  
† = Should your car need repairing following an accident we provide a courtesy car (subject to availability) for the duration of the repair. Only genuine Vauxhall parts are used. Terms and conditions apply.  
†† = Calls may be recorded. Vauxhall Insurance is underwritten by Ageas Insurance Limited.

## FOR MORE PRODUCT INFORMATION

For further information on the Vauxhall range or location of your nearest Vauxhall Retailer please call **0345 600 1500**. Alternatively, details can be found on our website at [www.vauxhall.co.uk](http://www.vauxhall.co.uk)

## JOIN US ONLINE:



Privacy Policy – For full details please visit: [vauxhall.co.uk/privacy](http://vauxhall.co.uk/privacy)

The invoice price, including delivery to Retailer, factory-fitted options, accessories fitted by the Retailer and number plates, is subject to VAT. Some feature descriptions in this guide may refer to, and some illustrations may show, optional equipment not included in the standard delivery. The information contained in this guide was accurate at the time of publication. We reserve the right to make changes in design and equipment. Please note that Vauxhall Retailers are not the agents of Vauxhall Motors Limited and are not authorised to bind Vauxhall Motors Limited by any specific or implied undertaking or representation. It is advisable to ensure that your motor insurance policy provides adequate cover for additional fitted options and accessories. The colours in this guide are only approximate actual colours. Illustrated optional equipment is available at extra charge. Availability, technical features and equipment provided on our vehicles can vary by model. For precise information on the equipment provided on our vehicles, please contact your local Vauxhall Retailer.

# VAUXHALL

[vauxhall.co.uk](http://vauxhall.co.uk)

©2019 Vauxhall Motors Limited

Published 1 January 2019 (Amended 18 March 2019) Vauxhall Motors Limited