

AMPERA

2013 Models Edition 2



Proud Sponsor of Home Nations Football



WELCOME TO A LIFETIME OF FORWARD THINKING



VX_BPS_18771

1903 – Forward thinking has been in our nature from the very start. The 6HP, our first ever car, had two forward gears. And no reverse.



VX_BPS_18772

1922 – The Silver Arrow OE 30-98 was capable of speeds of over 100mph, this model was built for shipping magnate Sir Leonard Ropner to race at Brooklands.



VX_BPS_18773

1937 – The Vauxhall '10' H-type, the first British car to have integral construction.



VX_BPS_18774

1957 – The PA Cresta introduced Americana styling to the UK.



VX_BPS_18775

1984 – The MkII Astra introduced class-leading aerodynamic styling that still looks good today. The Formula Vauxhall Lotus ran a modified version of the Astra GTE's 2.0i 16v engine.



VX_BPS_18776

1971 – The formation of Dealer Team Vauxhall (DTV). The track car was the precursor to our enormous success in touring car racing.



VX_BPS_18777

1999 – The Zafira introduced the revolutionary Flex7® seating system inventing the seven-seat compact MPV.



VX_BPS_18780

2012 – Ampera. The first ever Extended-Range Electric Vehicle (E-REV) that redefined electric vehicle innovation leading to it being voted European Car Of The Year 2012.



VX_BPS_18782



VX_BPS_18779

1990 – The Calibra was the world's most aerodynamic production car.



VX_BPS_18781

Scan this QR code with your smartphone for more information on the last 110 years of Vauxhall innovation. Don't forget to download a QR reader from your app store first.



VX_BPS_18778

1989 – The Lotus Carlton was the world's fastest production four-door saloon.

The world was a very different place in 1903 when Vauxhall made its first car. We steered with tillers, not wheels. Six horsepower was considered pretty nippy. And King Edward's face was still on the stamps. But for us, one important thing hasn't changed: we started out with a philosophy of Forward Thinking and, 110 years later, it still motivates everything we do. Who knows what innovations the next 110 years will bring?

The Vauxhall Lifetime Warranty. There's one thing every owner of a new Vauxhall can rely on. We're so confident in Vauxhall quality and reliability that we are now able to offer a lifetime warranty. It's available to the first owner of all our new Vauxhall passenger cars and valid for the lifetime of the vehicle up to a maximum of 100,000 miles. So you've got year after year of carefree driving to look forward to...



Please see back cover for full details of the Vauxhall Lifetime 100,000 mile warranty.

LIFETIME
WARRANTY 100,000 MILE

CONTENTS

AMPERA

Exterior styling	8
Interior styling	12
Propulsion system	16
Charging modes	18
Driver information	20
Driving dynamics	24
Safety	26
Comfort and convenience	28
Infotainment	30
Ampera models	32
Accessories	36
Colours and trims	38
Specification	40
Questions and answers	42

This brochure covers Ampera Positiv and Electron models only. Some of the images illustrate options and accessories available at extra cost. And not all of the features described are available on both models. We may also offer alternative Ampera models such as Special Editions. So for all current model or equipment details visit the Vauxhall website: www.vauxhall.co.uk





REVOLUTIONS START IN THE STREETS

Revolutions are about breaking free and bringing about change. The Ampera has a positive environmental ethos that benefits your lifestyle and mobility. It uses electricity alone to drive for up to 50 miles and uses a petrol-powered generator to provide the electricity that allows you to drive up to a further 310 miles. Read on and discover how the Ampera is redefining electric vehicle innovation and why a panel of 59 leading motoring journalists from 23 European countries voted it European Car Of The Year 2012.

For more information and to find your nearest Ampera retailer please call us on 0207 192 1181 or visit: www.vauxhall-ampera.co.uk

DRIVING ELECTRICITY FURTHER

Change the game, change the world. This philosophy has put Vauxhall at the forefront of developing alternative propulsion that uses renewable resources, reduces our dependency on oil and offers you numerous benefits. The Vauxhall Ampera is an Extended-Range Electric Vehicle (E-REV) – the first of its kind on sale in Europe. And it succeeds where pure battery cars are limited, by combining extended-range with improved performance, reliability and handling.

The 16kWh rechargeable lithium-ion battery powers the Ampera for up to 50 miles* of cost-effective battery-powered motoring – making it ideal for commuting. For longer trips, the innovative petrol-powered generator provides the electricity to power the drive unit, allowing you to drive up to another 310 miles* without having to recharge or refuel.

*For details and determination methods, see technical data on page 25.







DOING THE RIGHT THING NEVER LOOKED BETTER

Take possession of the machine that makes it exciting to be 'eco'. With an aggressive, low stance and aerodynamic, stylish lines, the Vauxhall Ampera makes a bold statement that's about more than just environmentally aware technology. The sweeping roof line, boomerang-shaped headlights, split tail lights and 17-inch five-Y-spoke alloy wheels give this sporty electric hatchback a head-turning design.



Discover the shape of electric propulsion.

All you have to do is scan a picture of the QR code using a smartphone with QR code reader installed.

RESISTANCE IS FUTILE

The Ampera's shape is beauty with a purpose. Aerodynamics and airflow played a key role in the sculptured design. Reducing drag improves efficiency, meaning you can drive further and for longer. The sleek and smoothly sculpted front, streamlined roof and aerodynamic door mirrors are designed to improve airflow. Vertical slots on the rear bumper and the lightweight polycarbonate wheel inserts not only reduce drag, but also add to the Ampera's sporty, high-tech appearance.





THE FUTURE STARTS HERE

Step into a world of innovation. The interior of the Ampera combines elegant comfort and roominess with state-of-the-art functionality and usability. From its interactive colour central instrument display to voice recognition technology, all contained within the dynamic flow of the wrap-around fascia. Two high-definition displays and superb in-car ergonomics offer you a clear view of the gauges and easy access to functions and controls. Standard features include a hands-free mobile phone system with Bluetooth®, digital radio, a leather-trimmed interior and electronic climate control.



VX_AMP_18739







Electric without compromises. Take a closer look at the Vauxhall Ampera and discover exactly what makes this revolutionary car so unique.

➤ FOR MORE RANGE WE WENT THE EXTRA MILE

E-REV stands for Extended-Range Electric Vehicle. The Ampera's E-REV technology delivers 25-50 miles* of battery electric driving, plus an extended range of up to 310 miles* using its on-board petrol-powered generator. So it offers all the convenience of a conventional car engine, but with significantly lower emissions and running costs.

The Ampera has two driving modes: Electric and Extended-Range Electric. In Electric Mode, the Ampera is powered by its battery and can be driven in this mode for between 25 and 50 miles*. Then when the battery runs low, the Ampera seamlessly switches to Extended-Range Electric Mode and its petrol-driven generator takes over. The generator produces the electricity for the motor and increases the range by up to a further 310 miles* and the driving experience is the same in either battery or Extended-Range mode. Thanks to this innovative system, you can be entirely confident that you'll reach your destination – just as if you were driving a conventionally powered car.





The E-REV system has three key components: the electric drive unit, the battery system and the generator. All three can be monitored on the centre console display.

1. The 150PS electric drive unit. Together with the battery system or generator, the electric drive unit produces 370Nm of torque and accelerates the Ampera from 0-60mph in less than nine seconds, with a top speed limited to 100mph in both Electric and Extended-Range Electric Modes.

2. The long-life battery system is durable and powerful. Mounted centrally under the floor, it gives the Ampera a low centre of gravity and generous boot space. Unlike other systems that are temperature sensitive, the Ampera's battery features an effective cooling and heating system that can withstand extremes of heat and cold.

To ensure long battery life, it is never fully charged or fully depleted and this 'smart' use cycle is so reliable that it comes with a 100,000 mile or eight-year warranty**. The battery level benefits from energy recuperated by the Ampera's regenerative braking system. When the car is braking or slowing down, the Ampera converts much of the kinetic energy of its forward motion into electrical energy stored in the battery.

3. The generator is powered by a 1.4 litre, 16-valve VVT ECOTEC® petrol engine that generates 86PS. This fuel-efficient, low-emission unit kicks in once the battery reaches its minimum state of charge or when the driver selects Hold Mode†. On a full tank, it will be up to another 310 miles before you need to refuel to continue your journey.



Get to know the heart of the Ampera: the revolutionary propulsion system for permanent electric drive. All you have to do is scan a picture of the QR code using a smartphone with QR code reader installed.

*For details and determination methods, see technical data on page 25. **Subject to the warranty conditions as outlined in the Vauxhall Ampera service booklet. †See page 25 for details.

➤ PLUG AND GO

Charging the Ampera battery is simple. Just plug one end of the charge cable into the charge port on the passenger side front wing, and the other into a 240-volt socket on a separate circuit* or the accessory home charge station, and you can charge the vehicle at home. Or if you're out and about you can plug in at a suitably equipped public charge station using a Mode 3 charge cable^{††}.**

To make sure charging goes without a hitch, the Ampera's charge cable is fitted with LED status indicators. If all the lights are green you know it's safe to go ahead and charge the Ampera. If any flash red, due to voltage or other electrical outlet faults, the car won't charge. In the cabin, a light mounted on the fascia just inside the windscreen shows the charge status.



There are three charging modes, designed to let you charge the Ampera when it suits you best. Immediate Mode charges the battery as soon as you plug the Ampera into a 240-volt socket. Delayed Departure Time Mode calculates when to start charging according to the departure time you enter on the centre console display. Delayed Rate and Departure Time Mode lets you charge the Ampera when it's least expensive – for instance using an overnight 'economy' tariff. The system will even work out the best charging time, using a combination of the utility rate information and your chosen departure time.

Battery charging times	Hrs
Standard charge cable using 240-volt socket*	6 [†]
Accessory 240-volt/16amp home charge station**. Public charge station using Mode 3 charge cable ^{††} .	4 [†]



VX_AMP_17329

The charge port is conveniently located on the passenger side of the vehicle, and is safe and simple to use. Just activate the remote charge port flap release on the key fob, or from inside the car, and plug in the supplied charge cable set. At home, just plug into a 240-volt socket on a separate circuit* or the accessory home charge station**. It's as simple as that. When you're out and about you can plug into a public charge station^{††}.



VX_AMP_18740

The standard charge cable set comes with a practical handle and fits in a special location in the boot of the car. It has a six-metre cable that rolls up tightly for easy storage.

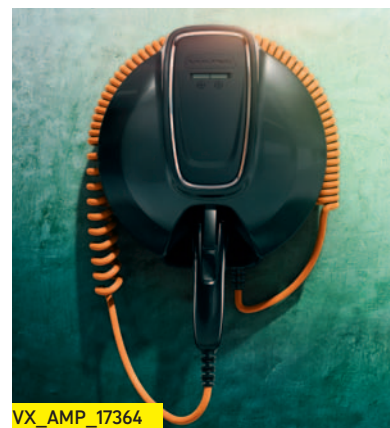

VX_AMP_17364

The 16amp home charge station is available as an accessory. This wall-mounted charging kit has an extra-long, extendable cable and can be installed in your home or garage**.

*Before charging at home with the standard charge cable, ensure that the capacity of the electrical circuit and socket that you intend to use has been inspected and approved by a qualified electrician.

**The home charging station must be connected direct to the power supply and the work must be carried out by a qualified electrician.

†Average charging time required under average weather and temperature conditions. Actual charging time will depend on factors such as temperature and the specification of the electrical installation.

††The car may also be charged at a public charge station with an IEC 62196-2 Type 2 inlet using a Mode 3 charge cable available as an accessory from your supplying retailer. Access to public charge points may require membership of a scheme or pre-purchase of an RFID (Radio Frequency Identification) card. Care must be taken not to leave the charging cable where it could become a trip hazard.

➤ JUST SCIENCE, NO FICTION

Two high-definition displays are the interface between you and your Ampera. The Driver Instrument Panel is all about peace of mind. The centre console touch-screen gives you access to infotainment, satellite navigation and climate control features, as well as power flow information and charging schedules.

Driver Instrument Panel operates in two modes. In Electric Mode (far right), it highlights the battery level, expected range and speed on the left of the screen. In Extended-Range Electric Mode, when the car is using the petrol-powered generator, the fuel gauge is more prominent and the battery gauge is greyed out. There's also a choice of two views. The Simple Configuration View displays the battery level and remaining range, along with the speedometer. Enhanced View switches to a real-time driving efficiency gauge that shows you how efficiently you are driving the Ampera.





18:16

ng

FIG

198 mi



44 mi

0 mph

462.3 mi
0.2 gal
avg 250.0 mpg

P R N D L

accel



brake

628 mi

RES/+

SET/-

SRC

DRIVE MODE

➤ KNOWLEDGE IS POWER

Electricity makes cars fit for the 21st century, and the Ampera's interactive centre console screen does the same for in-car displays. If you get a kick out of the latest electronic gadgets, you'll love using the Ampera's control centre. It does more than just give you access to key information and features. At the touch of a finger it brings the whole car to life.

The seven-inch centre console display couldn't be clearer or more intuitive to use. With just a few touches you can choose music and the best route, programme the Ampera's charging schedule, and monitor power flow. Your options and choices show up clearly as attractive coloured graphics. This central display also serves as the control panel for the Electronic Climate Control (ECC). Since air conditioning uses power and can therefore affect the Ampera's range – in Electric Mode – the ECC offers three different climate modes: Fan Only, Eco and Comfort. You select the ideal trade-off for your needs. A climate efficiency gauge shows you in real time how your ECC choices affect power consumption – and there are even efficiency tips to ensure you get the best range possible.



VX_AMP_20142

1. The charging display. When the system needs recharging, you can pick a charging mode and programme the charging schedule on the centre console display. Once charging begins, the charge status and current driving range in Electric Mode appear on the Driver Instrument Panel.

2. The Power Flow display. The centre console gives you a clear animated overview of the Ampera's drive systems, so you always know exactly which power source you're using, as well as how long it will be before you need to recharge or fill up. A simple touch of the Power field (bottom left) activates the display. In Electric Mode the battery glows green **3.** When the engine engages the petrol-powered generator, the battery animation fades out and the generator glows instead.



VX_AMP_17343



VX_AMP_17341



VX_AMP_17342

▶ PERFORMANCE WITHOUT COMPROMISE

The Ampera is quick and power efficient. With 370Nm of torque you can accelerate from 0 to 60mph in less than nine seconds, and do it with the almost silent electric drive unit. Whether you're in Electric Mode or Extended-Range Electric Mode, the 150PS electric drive unit powers the front wheels at all times, with a limited top speed of 100mph.



Engineered to perform, the Ampera features four performance modes for varying driving conditions and styles:

Normal Mode: The default setting and most efficient driving mode, using the lithium-ion cells as long as possible, and then engages the on-board generator.

Sport Mode: Automatically reconfigures the response of the accelerator pedal to provide quicker torque application for dynamic driving situations.

Mountain Mode: Automatically adjusts the system for efficient performance in extreme gradients, such as very steep alpine inclines, keeping the battery at a higher state of charge for when supplementary power is required.

Hold Mode: Allows you to drive using the petrol-powered generator to conserve the energy of the battery, then switch to battery for inner-city driving.

The shift lever resembles a conventional automatic selector (Park, Reverse, Neutral, Drive), the Ampera also has a 'Low' setting which increases the resistance of the regenerative braking system, maintaining battery charge and extending the life of the brakes.

The suspension is tuned for responsive driving dynamics. The independent MacPherson strut-type front suspension improves stability whilst at the rear there's a semi-independent set up.

The braking system draws on two different technologies: regenerative braking and disc brakes. Regenerative braking can handle more than 90% of braking situations. It harnesses the kinetic energy of the car's forward motion during deceleration and converts much of it into electrical energy that can be stored in the battery. For more extreme braking, the Ampera automatically combines the regenerative and more powerful disc brakes. Under urgent braking situations, emergency brake assist is automatically engaged and the system switches immediately to 100% disc braking.

The electric parking brake is released automatically when pulling away. You can also turn it on and off with a switch on the centre console.

TECHNICAL DATA	
PROPULSION SYSTEM:	
Electric drive unit: Power	150PS (111kW)
Electric drive unit: Torque	370Nm (273 lb.ft)
Lithium-ion battery	16kWh
Range-extender petrol engine	1.4i 16v (86PS) (63kW)
FUEL ECONOMY MPG (LITRES/100KM)*:	
Combined/weighted figure	235.4 (1.2)
TYPICAL ECONOMY MPG (LITRES/100KM)*:	
Condition A – Battery only	0 (0.0)
Condition B – Range extender	56.5 (5.0)
CONSUMPTION AND EMISSIONS*:	
CO ₂ emissions g/km	27
RANGE:	
Typical electric range**	25-50 miles
Total range†	360 miles
VEHICLE EXCISE DUTY (VED) AND BENEFIT IN KIND TAX (BIK):	
VED (2013/14) – first year and standard	£0
BIK 2013/14 tax years	5%

All information was accurate and up to date at the time of publication (February 2014). The company reserves the right to alter engine specifications at any time, which may influence the content of the shown data. Please consult your Vauxhall retailer for the latest information.

* = Fuel consumption data, CO₂ emission data, official electrical consumption data and official electrical range data are determined according to regulation R (EC) No. 715/2007 (in the version respectively applicable), taking into consideration the vehicle weight in running order, as specified by the regulation. Additional equipment may lead to slightly higher results than the stated consumption and CO₂ figures. Condition A: is the vehicle driving on Battery supplied electricity only. Condition B: is the vehicle running on Combustion Engine supplied electricity. Combined: is the vehicle running on combination of both.

** = Typical electrical range means the range achievable in battery mode with a fully charged battery under typical everyday driving conditions, modest use of engine performance and in average weather conditions (without use of additional electrical consumers). The range is substantially influenced by the driving style, payload, number of passengers, terrain, temperature and use of electrical systems e.g. air conditioning.

† = Cumulated range from battery electric and range-extender operation, based on the respective official combined consumption figures according to regulation R (EC) No.715/2007 (in the version respectively applicable). The figures for fuel consumption, electrical consumption, range and CO₂ emissions do not relate to a specific vehicle and are not part of an offer. They are provided only for the purpose of comparison between different vehicle variants. Additional equipment may increase the weight of the vehicle when empty, which may lead to a reduction in top speed and increased acceleration time. The published performance figures assume a 75 kg driver plus 125 kg load.

➤ YOU THINK YOU'RE SPECIAL? SO DO WE

The Ampera feels safe and secure, inside and out and easily achieved the top five-star Euro NCAP rating. Made from high-strength steel, the Ampera boasts an extremely rigid passenger cell that offers excellent protection – from the side and above – in the event of an accident. The battery, located in the centre of the car, is protected within a high-strength cage.



VX_AMP_17360

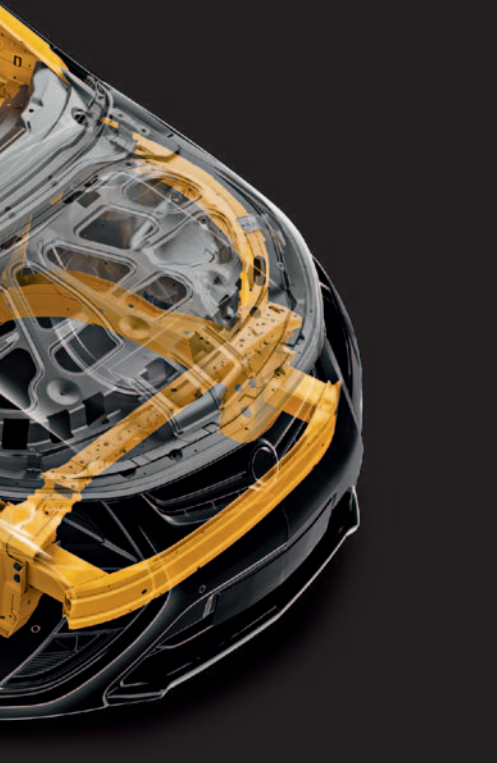

1. Eight airbags as standard. The Ampera has dual-stage front airbags and knee airbags, as well as side-impact airbags extending over both seating rows. Adjustable head restraints help protect against whiplash, whilst the pedal release system helps protect you in the event of an impact. All the seats feature three-point seatbelts, with shoulder-belt retractors and front seatbelt pretensioners.

2. Safety measures proactively prevent accidents. The Ampera has safety features which work to prevent potential problems developing into something more serious. Features include ABS and Electronic Stability Programme (ESP), which limits wheel spin or loss of traction. Because the Ampera is so quiet in Electric Mode, the driver can activate the pedestrian alert system which emits a chirruping sound to make sure people are aware of the car.

3. The rear view camera. Mounted above the Ampera's rear number plate, this camera shows the area behind the car on the centre console display, to help you reverse safely, using your rear bumper as a point of reference. The screen shows overlaid graphic lines indicating the reversing path based on the steering wheel's angle. Working in conjunction with the front and rear parking sensors, you quickly appreciate just how easy it is to reverse the car safely. Especially at night, when it combines with the rear central reversing light, to fully illuminate your path.

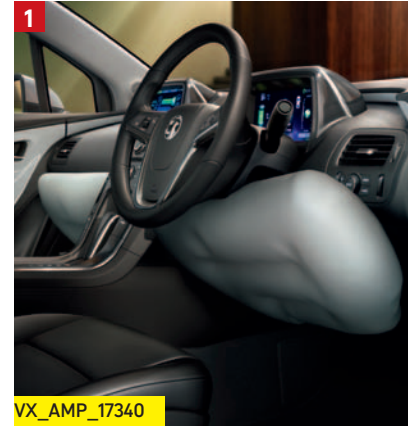

➤ THE SAME BUT DIFFERENT

The Ampera offers the same convenience and comfort as you'd expect from a conventional car, but with a big difference in the emissions. There's ample room for four people – and plenty of innovative surprises.



VX_AMP_18744

Remote Start warms up or cools down the car before you even get in. A button on the key activates the climate control system, which pre-conditions the cabin temperature. The most efficient way to use this system is to operate while charging, so not only does this make life more pleasant, it also ensures that the battery pack is kept fully charged for your next journey.

Remote keyless entry and keyless ignition are standard, with the propulsion unit activated by pressing the power button. Four supremely comfortable, leather-trimmed seats are standard, and both front seats can even be heated remotely before you start your journey. With anti-theft protection as standard, the car alarm will sound and exterior lights will flash if any attempt is made to enter the Ampera before it's unlocked, or if the charge cable is removed from the charge port.



The front centre console comes with USB, aux-in socket and 12V power outlets for your mobile phone and MP3 player. The rear seat console also has a 12V outlet. Both consoles offer storage space for small items and two cup holders.



The 300-litre boot provides plenty of room for your gear. If you need more space, the rear seats fold down separately to allow a maximum 1000-litre capacity. In the boot, the recessed compartment under the floor stores the portable charge cable set and emergency tyre inflation kit. For smaller items, the cabin offers storage opportunities in the front and rear centre console as well as the door pockets.

▶ ULTIMATE SOUND AND VISION

Informative, entertaining and state-of-the-art, the Vauxhall Ampera offers easy access to premium high-tech via the two interactive displays and the controls on the centre console or steering wheel – so your journey is as enjoyable and smooth as possible.



VX_AMP_17350



1. One-touch connectivity. The Ampera gives you fingertip access to all your multimedia settings, including Bluetooth® connectivity. You can take and make phone calls safely using the steering wheel remote controls, which also gives you instant control over audio and navigation features.

2. The dynamic sat nav system. All Amperas feature a seven-inch colour display on the centre console, in Electron models this houses the sat nav system, which offers real-time traffic and points of interest activated via the user-friendly touch screen. You also get 30GB of storage space which can be used for storing audio files such as MP3 tracks and audio broadcasts recorded with the 'timeshift' function.

3. The premium sound system. Standard on the Electron model, the Bose® energy efficient sound system with six high-performance speakers and a subwoofer delivers a superior listening experience whilst using less energy. The standard sound system features an AM/FM and digital radio, CD player, an aux-in socket, Bluetooth® connectivity and USB functionality.





Decision time. With so many features as standard, the Vauxhall Ampera makes any journey more enjoyable. But doesn't make your decision any easier.

Standard features include:

- Driver's and front passenger's airbags
- Front seat side-impact airbags • Full-size curtain airbags
- Electronic Stability Programme-plus (ESP-plus) with traction control and emergency brake assist
- Anti-lock Braking System (ABS)
- CD/MP3 CD player with stereo radio
- Digital radio
- USB connection with iPod control • Aux-in socket
- Mobile phone system with Bluetooth®
- Multi-function trip computer
- Electronic Climate Control (ECC)
- Cruise control
- Automatic lighting control
- Electric parking brake
- Electrically operated front and rear windows
- Electrically adjustable/heated door mirrors
- 17-inch five-Y-spoke alloy wheels with aero covers **1.**
- Leather trim with electrically heated front seats
- Leather-covered steering wheel
- Rear view camera
- Front and rear parking distance sensors
- Remote control security alarm
- Velour floor mats



Insurance group (ABI)

20E T1

ELECTRON



Additional features over and above Positiv model:

- Sat nav/DVD player
 - Sat nav system with voice activation **1.**
 - 'Pseudo 3D' street level mapping for 20 European countries
 - Audio/video DVD player
 - Hard drive device with 30GB music file capacity
 - Bose® energy efficient sound system with six high-performance speakers and single subwoofer **2.**



➤ MAKE SOMETHING SPECIAL UNIQUE

This is a car that's designed to be driven every day, for short commutes and longer trips. With some well-chosen, Genuine Vauxhall Accessories, you can make your Ampera the perfect fit for your daily routine and requirements.



1. The fitted elastic cargo net keeps breakables safe. Plus, you can store smaller, frequently used items in one place so they're easy to get at.

2. The 16amp home charge station. This wall-mounted charging kit has an extra-long, extendable cable and can be installed in your home or garage*.

3. The windscreen sunshade helps keep the Ampera cool on sunny days, reducing the need for air conditioning and thus saving energy. It's easy to install and folds away neatly in the storage bag provided.

4. The foldable boot liner protects the loadspace and bumper when you're loading and unloading bulky items. To keep the boot clean, there's a non-skid hard cargo liner that neatly fits on the luggage compartment floor.

5. Mode 3 charge cable allows you to charge whilst out and about away from home, where public charging units have Type 2 Menekes sockets.



*The home charging station must be connected direct to the power supply and the work must be carried out by a qualified electrician.

➤ GENERATE ATTENTION

The Ampera is available in a range of exterior colours and finishes – all electrifying in their own way.

Please note, there may be limited availability on certain colour and trim combinations. Please check with your Vauxhall Ampera retailer for further details.

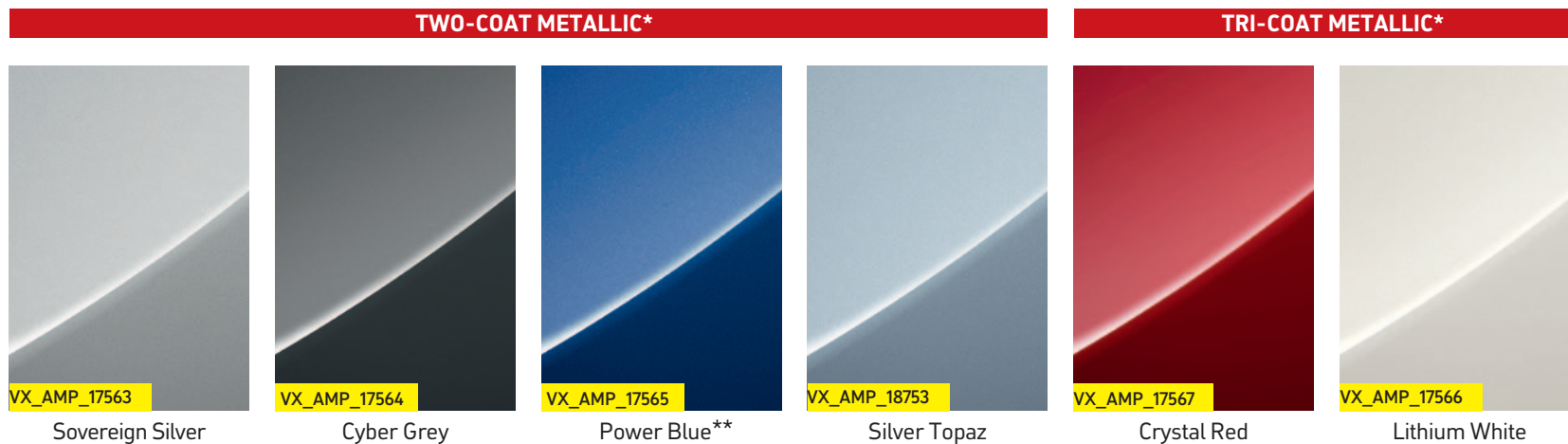
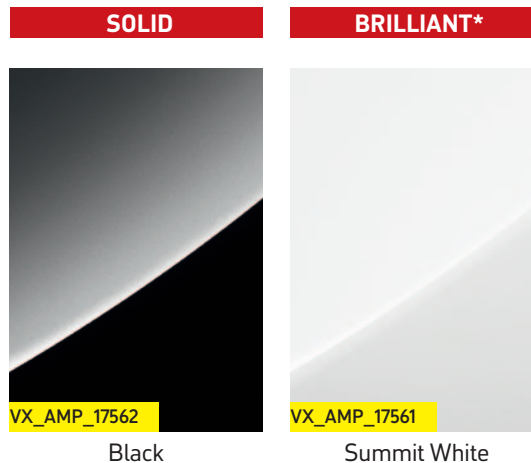

*Optional at extra cost. **Spice Red trim is not available in conjunction with Power Blue metallic paint.

Due to the limitations of the printing process, the colours reproduced may vary slightly from the actual paint colour and trim material. As a result, they should be used as a guide only. Your Vauxhall Ampera retailer has a comprehensive display of our paint samples and trim swatches.

➤ CURRENT CHOICES

A choice of interior trims – including the option of red or white style inserts for the leather seats, door trim and fascia – means the interior of your Ampera can be as individual as the Ampera itself.

SPICE RED TRIM**



VX_AMP_17404



VX_AMP_17404

Black leather seat trim with Spice Red inserts, fascia inserts and front door panels.

CERAMIC WHITE TRIM



VX_AMP_17405



VX_AMP_17405

Black leather seat trim with Ceramic White inserts, fascia inserts and front door panels.

E-REV Power

	Electric drive unit	Battery	Range extending petrol generator	
Type	E-FLEX motor	Lithium-ion	1.4i 16v VVT ECOTEC petrol engine coupled to electric generator	
Maximum power	150PS (111kW) @ 5000rpm	16kWh	Petrol engine: 86PS (63kW) @ 4500rpm	Generator: 73PS (54kW)
Maximum torque	370Nm (273lb.ft.) @ 250-2800rpm	-	126Nm (93lb.ft.) @ 4250rpm	-
Configuration	Permanent magnet electric propulsion motor. Located in multi-mode transaxle	45Ah battery pack with integral heating/cooling system. 6 hour recharge time (240v)	4-cylinder in-line petrol engine	Permanent magnet electric generator. Located in multi-mode transaxle

Performance, fuel economy, emissions and VED rates

	Performance (manufacturer's figures)		Fuel economy mpg (litres/100km)			CO ₂ emissions g/km	Vehicle Excise Duty*	
	Maximum speed (mph)	Acceleration 0-60mph (sec)	Urban driving	Extra-Urban driving	Combined/weighted figure		First year rate	Standard rate
Ampera	100	8.7	N/A	N/A	235.4 (1.2)	27	£0	£0

* = Correct at time of publication.

The "Combined/weighted" fuel consumption/CO₂ figures are calculated from two test results: one when the battery is fully charged and the other when the battery is discharged. The two test results are a weighted average, taking into account mileage range on battery power only, providing a figure in a variety of charge conditions. Extended range achieved by 1.4 litre 16-valve VVT ECOTEC® petrol engine generating electricity.

Tyre rating

Tyre size	Fuel efficiency group	Wet grip performance	External noise	
			Measured (dB)	Group
215/55 R 17	A	B	71	

Fuel tank capacity

35.2 litres (7.7 gallons)

Comprehensive specifications and technical data is available in the PDF price/specification guide available at www.vauxhall.co.uk under 'Request a brochure'

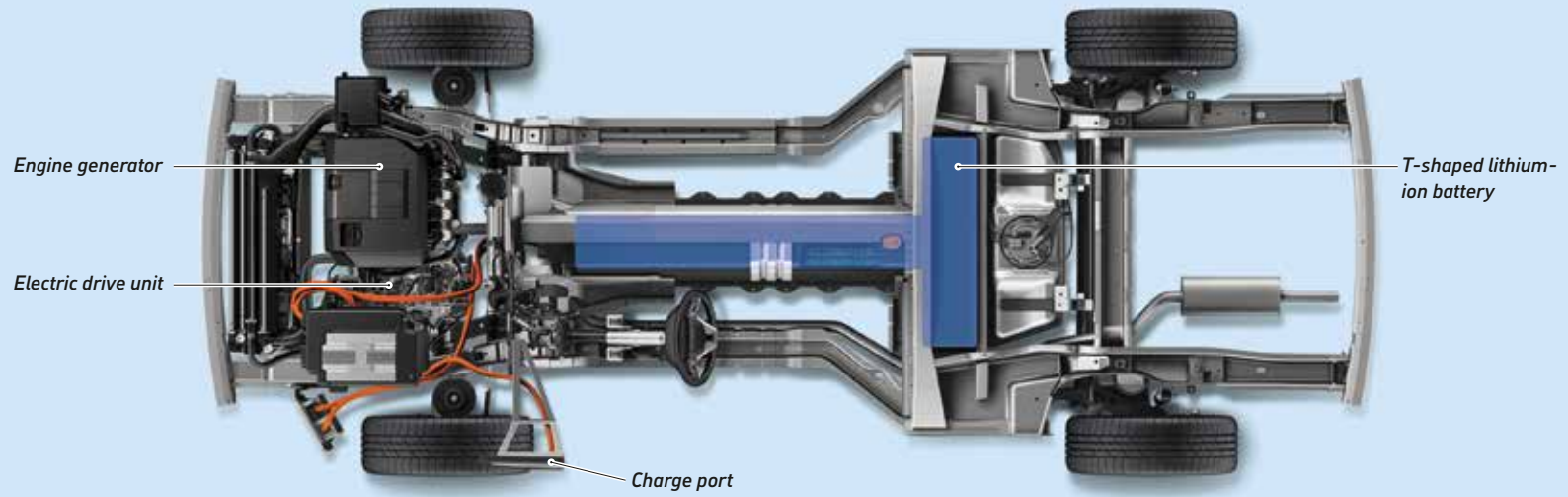

Engine generator

Electric drive unit

Charge port

T-shaped lithium-ion battery

Left hand drive model illustrated.

Is the Ampera an electric vehicle?

Yes. The Ampera is a full-performance battery electric vehicle with extended-range operation. The Ampera can achieve full performance on battery power alone.

Why is the Ampera not considered a hybrid?

Unlike traditional hybrids, which use electric power to supplement the mechanical power provided by the engine, the Ampera leads with the battery power, which is then supplemented by electricity generated by the on-board 1.4 ECOTEC® engine. The Ampera cannot operate solely on power provided by the engine and as such it is not a hybrid in the conventional sense.

In what condition and how often is the Ampera powered by both electrical and mechanical power?

The electric drive unit always requires the use of electricity, which under specific conditions can also be combined with mechanical power to the electric motors that drive the wheels to provide a significant improvement in efficiency. This unique balance of power, only in extended-range high-speed operation, also helps to boost fuel economy by upwards of 15%.

What incentives are available?

The Ampera qualifies for the Government Plug-in Car Grant (PiCG) which provides a discount on the purchase price of 25% up to £5,000. The Ampera also falls into tax band A with zero VED*. In London the Ampera will be congestion charge exempt (on payment of a £10 registration fee).

* = Current at time of publication. Company Car drivers benefit from a discounted Benefit in Kind taxation rate of just 5%, while companies that purchase Ampera are eligible for First Year Capital Allowances.

Is there a special infrastructure regarding the dealer/service support?

Yes. Vauxhall has 25 specially qualified dealers and service partners who are trained in the revolutionary propulsion system.

Where can I find out more information about Ampera?

You can visit our website at: www.vauxhall.co.uk/ampera or download the 'myAmpera' app, which is free to download for both Android and iPhone devices.

What is the battery recycling plan at the end of the battery's life cycle? Any European specific recycling plan since Europe has different infrastructure?

The batteries will have a significant amount of energy storage remaining at the conclusion of their automotive life cycle. The energy storage that remains will have an economical value to a variety of industries (most notably the power industry). Processes for recycling lithium-ion batteries for consumer goods such as mobile phones occur today with very little environmental impact. The batteries, following their post-automotive application life cycle, will be recycled in a similar manner.

Wouldn't a diesel engine be more efficient than a petrol engine?

In an E-REV like the Ampera, the engine generator runs like a stationary engine in the most efficient areas of the fuel map. In those areas the petrol engine is as efficient as a diesel engine. Also, the emissions of petrol engines are much lower than those of diesel engines, which need more sophisticated after-treatment systems.

How can I charge the vehicle at home?

Whilst the six metre long portable charging cable stored in the boot is designed to be used in a three-pin household socket on a separate circuit, we take our duty of care very seriously and as neither Vauxhall nor our Retailers are qualified to give home electrical advice to customers we have enlisted the services of British Gas.

All customers are entitled to a free home assessment, carried out to Institute of Engineering and Technology (IET) electrical specifications for charging an Electric Vehicle, by a British Gas engineer.

Should you have any enquiries, please call British Gas on **0800 980 8175** quoting AMPERA.

What do the Ampera fuel and CO₂ figures really mean?

Fuel Consumption and CO₂ figures are obtained from a standard test driving regime on a rolling road in laboratory conditions. Each vehicle manufacturer has to test a new car they bring to market or a new engine variant to receive a European Type Approval Certificate before the vehicle can effectively be sold in Europe and Registered with the Country Authorities. This enables a customer to compare all vehicles and their performance in this test as each vehicle is tested in an identical way.

With Ampera the test is done using the lithium-ion battery pack and there are no emissions whilst the car is being driven. When the petrol engine is used to generate electricity to power the electric drive system it burns petrol and CO₂ emissions are generated. Within the test this provides a result of 56.5mpg and 116g/km. So how efficient is this?

Take an Astra 1.4 VVT (87PS), this has a Combined fuel efficiency of 51.4mpg and CO₂ of 129g/km. As the Ampera engine is not attached to a conventional gearbox, it sits generating electricity alone rather than driving the wheels and consequently will be more fuel efficient.

This can also be viewed in terms of the relative weights of the Ampera versus an Astra, i.e. it is carrying a lithium-ion battery pack which is some 198kg of additional weight, so in a heavier vehicle this fuel efficiency is more impressive. However, remember, the 1.4 16v VVT (86PS) engine from Ampera is generating electricity for the 150PS electric drive unit, so the customer always drives with the 150PS.

Many owners will aim to drive their Ampera on battery energy as much as possible and where 85% of the UK commuting population is driving less than 25 miles per day (*EcoAuto*, May 2010), then they will achieve their goal of not having to generate additional electrical energy from the petrol engine.

When an Ampera owner wants to drive a considerable distance, e.g. on holiday from Yorkshire to Cornwall, they still have that ability in the one car they have purchased, with the generation of electricity by the petrol engine. Ampera can be your only car.

The EU Type Approval figures do not take account of the CO₂ generated by the UK and European power stations that feed the UK national grid. On average, each kilowatt/hour (kWh) of electricity generated in the UK emits 545g of CO₂ (2 November 2011, *Autocar*) – this is not included within the EU Type Approval figures.

Note also that the emissions from the extraction, production and transportation of petrol and diesel are not taken into account in the official emissions of conventional cars.

Will the launch of electric vehicles not require the production of more electricity?

The first generation of electric vehicles will have a limited volume and therefore the impact on the electricity grid will be extremely small.

Are lithium-ion batteries safe? Is there a risk they will catch on fire?

We will not introduce a vehicle that has any sort of safety issue. All of us are drivers of these vehicles and so we want to take care of our friends and our families as well.

Will the Ampera support AC or DC quick charging?

No, quick charging is not supported by the Ampera.

Can you choose between an automatic and manual gearbox?

There is no manual gearbox. The Ampera drives like a car with automatic transmission.

Is the Ampera available with a tow bar?

The Ampera is not engineered to tow a trailer. The vehicle is designed to be aerodynamic and to achieve the maximum range possible.

Can I put a ski box or a ski rack on the roof?

The Ampera is not designed for roof loading, again to make the vehicle as aerodynamic as possible.

Can I install child seats in the car?

Vauxhall offers a range of child seats and child seat restraint systems for children of all age groups that comply with the latest EU safety standards including side-impact protection. For easy installation and safety child seats can be fixed with ISOFIX attachments and/or the standard lap and diagonal seatbelts.

Trust Vauxhall

Fleet Customer Services

Our dedicated support services for fleet decision makers include factory demonstrators and information on whole life costs, company car taxation and finance.

For further information please call
0870 010 0651.

E10 Fuel

E10 fuel is cleared for use in all petrol-engined Vauxhall vehicles excluding models with the 2.2 litre direct injection petrol engine (code Z22YH) used in Vectra, Signum and Zafira models. Owners of these vehicles should continue to use regular unleaded or premium unleaded petrol.



For more information...

For a brochure on any Vauxhall model (up to a maximum of three per caller) or location of your nearest Vauxhall retailer please call
0845 600 1500.

Alternatively, details can be found on our website at www.vauxhall.co.uk

Join us online:



FSC® certified print product.

This brochure is produced from 100% recycled fibre.

www.fsc.org



Scan this QR code with your smartphone for more information. Don't forget to download a QR reader from your app store first.

Proud Sponsor of Home Nations Football



Vauxhall Lifetime Warranty

We're so confident in Vauxhall quality and reliability that we are now able to offer a lifetime warranty. Available to the first owner of all new Vauxhall passenger cars, it's valid for the lifetime of the vehicle up to a maximum of 100,000 miles*. In addition, our warranty also includes Vauxhall Assistance for 12 months from first registration and six years body panel anti-perforation warranty. Full details of Vauxhall's warranties including terms, conditions and exclusions can be obtained through any authorised Vauxhall retailer or go to: www.vauxhall.co.uk/warranty

LIFETIME
WARRANTY 100,000 MILE

*Vauxhall Lifetime Warranty covers lifetime ownership of first car owner, 100,000 mile limit, annual check required. Ampera battery is subject to a separate eight-year/100,000 mile warranty, subject to the conditions outlined in the Ampera service booklet. The warranty excludes wear and tear and serviceable items and the vehicle must be serviced in accordance with the manufacturer's servicing schedule to continue the lifetime warranty. Terms and conditions apply. Offer available to all Vauxhall passenger cars (this offer does not apply to car-derived vans) from 1st August 2010.

Every effort has been made to ensure that the contents of this publication were accurate and up-to-date at the time of going to press (February 2014). Vauxhall vehicles are equipped with components manufactured by various General Motors operating units and outside suppliers. The Company reserves the right to alter specifications and withdraw products from sale without notice. Any such alterations will be notified to Vauxhall retailers at the earliest opportunity; please consult your local retailer for the latest information. The specifications detailed within this brochure are not necessarily applicable to alternative models such as Special Editions. Details of any such models will be contained in specific literature or found on the Vauxhall website. Please note that Vauxhall retailers are not the agents of General Motors UK Limited and are not authorised to bind the Company by any specific or implied undertaking or representation. It is advisable to ensure that your motor insurance policy provides adequate cover for additional fitted options and accessories. Please note accessories shown are for illustrative purposes only. As part of Vauxhall's policy of environmental care, this brochure is printed on paper produced from 100% recycled fibre using vegetable-based inks. All rights reserved. No part of this publication may be reproduced in any form or by any means, without the prior written permission of General Motors UK Limited.



VAUXHALL