

ASTRAVAN

2012 Models Edition 2



Proud Sponsor of Home Nations Football



The Wheels of Business. Helping you deliver.

Whatever your line of business, Vauxhall Commercial Vehicles can help you deliver. With five different models – including New Combo and the award-winning Corsavan – we offer a massive choice of almost 300 variants including panel vans, chassis cabs,

crew cabs, platform cabs, tippers, dropsides, box vans and passenger carriers. We're also committed to keeping your business moving. That means reliable, fuel-efficient vehicles – including our new ecoFLEX range – supported by a dedicated network of over



450 retailers offering the expert support and back-up you need. We build more commercial vehicles at our British production facilities at Ellesmere Port and Luton than any other UK manufacturer. We've also won over 30 industry awards since 2001 – major awards,

presented by some of the toughest judges in the business. Introduce the in-built reassurance of the Vauxhall brand and it's easy to see why Vauxhall Commercial Vehicles really are 'The Wheels of Business'.





Astravan



Astravan. The Ultimate Drivers' Van.

With its modern, sporty styling, it makes a positive statement about your business. There's a choice of powerful Euro 5 compliant 1.7CDTi 16v diesel engines including a CO₂ efficient ecoFLEX unit. Plus three generously equipped trim levels.

And with outstanding carrying capacity, it's always ready to get the job done. Yet with its dynamic chassis and supreme interior comfort, you might forget you're driving a van at all.

Today's Astravan. Club, Sportive or Sportive XP. The ultimate drivers' van.

Some of the vehicles shown in this brochure include options and accessories available at extra cost. And not all of the features described are available on every model. So please check the equipment and technical data section for further details. From time to time, we also offer alternative models such as Special Editions which are featured in separate literature or can be found on the Vauxhall website: www.vauxhall.co.uk/vans

06 Dynamics and efficiency
08 Loadspace
10 Interior, safety and security
12 Club

14 Sportive
16 Sportive XP
18 Options and accessories
20 Colours and trims

22 Customer testimonials
24 Equipment and technical data



Astravan Sportive

Dynamics and efficiency

There's no doubt that it looks good, and it's great to drive too. But don't let that distract you. There's a choice of three Euro 5 compliant common rail turbo diesel engines – including a low CO₂ 1.7CDTi 16v ecoFLEX unit – which match high fuel economy with extended service intervals for low running costs. Vauxhall was the first CV manufacturer to offer 'eco' versions across the entire line-up, reinforcing our commitment to environmental principles within the commercial vehicle sector. A fact recognised by *What Van?* with the 'Green' award in their 2012 honours.



Common rail diesels

Astravan comes with a choice of three powerful, high-torque, high-economy common rail, turbo diesel engines – 1.7CDTi 16v (110PS), 1.7CDTi 16v ecoFLEX (110PS) and a powerful 125PS version. Our ecoFLEX model embodies all the benefits of Vauxhall's ecoFLEX philosophy: with incredible economy and CO₂ emissions of just 132g/km.

These engines are matched to a manual six-speed gearbox as standard.

Low running costs

Commercial vehicle operators understand why we keep Astravan running costs low. Service intervals extend to 20,000 miles/one-year, plus there's a three-year/60,000 mile warranty.

Dynamic chassis

With precise power steering, genuine ride comfort and incredible agility, it's no surprise Astravan drives more like a car than perhaps any other van. Yet the chassis is specially tuned to the demands of everyday working life.

Great looks

Beautifully styled from every angle, Astravan's sharp, modern lines make a positive statement about any business. Sportive and Sportive XP models add extra visual appeal with body-colour door handles, mirrors and side-protection mouldings plus a dark-tinted rear window.

Must-have safety

Astravan provides a safe working environment with active safety features such as Anti-lock Braking and Emergency Brake Assist standard on all models. Astravan also features the addition of Electronic Stability Programme-plus, helping you gain control of the van in emergency situations.

Choice of engines:

- > 1.7CDTi 16v (110PS)
- > 1.7CDTi 16v ecoFLEX (110PS)
- > 1.7CDTi 16v (125PS)

Features include:

- > Three-year manufacturer's warranty consisting of a one-year/unlimited mileage warranty plus a second and third year warranty up to 60,000 miles
- > Anti-lock Braking System (ABS)
- > Electronic Stability Programme-plus (ESP-plus)
- > Emergency Brake Assist (EBA)



Loadspace

The Astravan load compartment provides 1.58 cubic metres of highly versatile loadspace with up to 650kg maximum payload. The optional Flex bulkhead with fold-flat passenger seat extends maximum load floor length from 1.82 to 2.68 metres.

From a practicality perspective, Astravan's tailgate lifts high to reveal a low loading height, a high, wide loading aperture, and a load area

that combines generous length, width and height with a broad, flat load floor. Width between the wheel arches is a full 1103mm.

A standard half-height steel bulkhead and half-height plastic sidewall panelling provide valuable protection against shifting loads. In addition, six load restraint lashing eyes allow you to secure your load, avoiding potential damage.



Loadspace dimensions*	mm	inches
Max. tailgate aperture height	766	30.1
Max. tailgate aperture width	1024	40.3
Max. load area height	900	35.4
Max. load area width	1376	54.2
Width between wheel arches	1103	43.4
Load floor length	1825	71.8
Load floor length with Flex bulkhead	2680	105.5
Flex bulkhead aperture width	531	20.9
Flex bulkhead aperture height	276	10.9
Loading height (unladen)	591	23.3

Loadspace volume	cu.m	cu.ft
All models (VDA method)	1.58	55.8

*Please refer to pages 29-30 of the technical data section for more detailed loadspace, weight and towing data.

Features include:

- > High-lift tailgate
- > 1.58cu.m loadspace volume
- > Up to 650kg payload
- > Low loading height (591mm)
- > Half-height sidewall protection panelling
- > Illuminated load area
- > Load restraint lashing eyes
- > Half-height steel bulkhead

Options include:**

- > Flex bulkhead with fold-flat passenger's seat
- > Upper load restraint mesh
- > Roof rails

**Not all features and options are available on every model. Please see pages 24-26 for details.

Relaxed and secure

When you're spending a long day on the road, it's good to know that Astravan is spacious, comfortable and easy to drive. But it's also reassuring to know that Astravan offers a high level of safety and security as standard. Indeed, Vauxhall have been voted Best Van Manufacturer in the British Insurance Vehicle Security awards.



Relaxing cabin

The Astravan interior has a bright, airy look, allied to high levels of comfort and practicality. With a height-adjustable driver's seat and an adjustable steering column – plus sports seats with lumbar adjustment on Sportive and XP models – the perfect seating position is easy to find.



Air con

Provides a fresher interior atmosphere. Standard on Sportive and Sportive XP, optional at extra cost on Club models.

Peace of mind

A high level of easy-to-use security features is important to every van user. Astravan's remote control central deadlocking, engine deadlock immobiliser and optional security alarm system ensure high levels of protection for your van and its cargo. In-cab safety measures include the fitment of twin front airbags and body-lock seatbelt pretensioners as standard with side airbags available across the range as an extra-cost option.



Seat comfort

Every model has reach and rake adjustable steering and all drivers' seats are height adjustable too.

Features include:*

- › Electric windows
- › Driver's seat height adjuster
- › Steering column adjustable for reach and rake
- › CD player/stereo radio (CD 30)
- › Sports seats with lumbar adjustment (Sportive and XP)
- › Leather-covered sports steering wheel with audio controls (Sportive and XP)
- › Air conditioning (standard on Sportive and XP, optional on Club)
- › Electronic engine deadlock immobiliser
- › Remote control central deadlocking
- › Remote control security alarm system (optional)
- › Twin front airbags
- › Body-lock seatbelt pretensioners

*Not all features and options are available on every model. Please see pages 24-26 for details.





Club

Astravan Club offers a superb package of comfort, convenience and safety features that defy its highly competitive pricing. And an extensive option and accessory choice makes it easier than ever to tailor your model to your unique operating needs.



Interior

The spacious and comfortable Club interior is trimmed in hardwearing Alpha cloth. Model illustrated features air conditioning and Interior Pack, optional at extra cost.



Electrically operated windows

With safety autoreverse and one-touch facility as standard.



CD player/stereo radio

A high quality audio unit featuring 17 watts per channel is standard.

Club features include:

- › Driver's and passenger's airbags
- › Anti-lock Braking System (ABS)
- › Electronic Stability Programme-plus (ESP-plus) with Traction Control
- › Matt chrome-effect centre console
- › Electric windows
- › Remote control central deadlocking
- › Steering column adjustable for reach and rake
- › Driver's seat height adjuster
- › CD player/stereo radio (CD 30)
- › Half-height steel bulkhead
- › Upper load restraint mesh (optional)



Engines

- > 1.7CDTi 16v ecoFLEX (110PS)
- > 1.7CDTi 16v (125PS)

Sportive

Astravan Sportive makes a serious style statement for the image-conscious business. The matt chrome-effect interior trim, sports seats and air conditioning all look and feel great. On the outside 16-inch Structure wheels, body-colour door mirrors, door handles and side-protection mouldings along with a choice of solid or two-coat metallic paint help complete the package. But don't forget its appetite for hard work – with two powerful common rail turbo diesels and payloads of up to 650kg.



Sportive interior

Sportive models feature Silver Alpha cloth seat trim with matt chrome effect centre console. Model illustrated features Interior Pack, optional at extra cost.



Sportive interior details

Maze chrome-effect inserts on doors and fascia give Sportive models further visual appeal.



Sportive details

Sportive models feature matt chrome-effect edging on instruments.

Additional features over Club model include:

- › Sports seats with lumbar and height adjustment
- › Leather-covered sports steering wheel
- › Maze chrome-effect inserts on fascia and doors
- › Steering wheel mounted audio controls
- › Air conditioning
- › Dark-tinted rear window
- › Twin electrically adjustable/heated door mirrors
- › Body-colour door mirrors, door handles and side-protection mouldings
- › Two-coat metallic paint
- › Roof rails

Engines

- > 1.7CDTi 16v (110PS)
- > 1.7CDTi 16v (125PS)



Sportive XP

Astravan Sportive XP builds on the Sportive model's inherently sporty character. Distinctive side sills and 17-inch alloy wheels give it even more punch in the style department, complementing Sportive's proven blend of body-colour detailing and solid or two-coat metallic paint.



Interior Pack

Optional Interior Pack (shown above) features cigar lighter and ashtray plus 12-volt electrical accessory socket in load area (not illustrated).



Rear style accents

Body-colour roof spoiler, lower skirt and bumper protection inserts add an extra touch of exclusivity.

Additional features over and above Sportive model include:

- › Body-colour front lower spoiler, rear roof spoiler, lower rear skirt and side sills
- › Body-colour rear bumper protection inserts
- › Lowered sports suspension
- › 17-inch alloy wheels with 215/45 R 17 tyres
- › Silver alloy-effect roof rails
- › Front fog lights



Engines

> 1.7CDTi 16v (125PS)

Winter Pack illustrated is optional at extra cost.

Options

Vauxhall options and accessories are all about choice – selecting your Astravan then personalising it to suit the way you work. There's a choice of factory-fitted options and a huge range of Genuine Vauxhall Accessories. You can also choose styling products from the auto design specialist Irmscher International. For further information please ask your Vauxhall Commercial Vehicle retailer for more details.



Flex bulkhead

Optional Flex bulkhead with fold-flat passenger seat extends maximum load floor length from 1.82 to 2.68 metres.



Air con

Optional on Club models, air conditioning makes for a fresher interior environment all year round.



Rear parking distance sensor

Activated as you select reverse. Beeps faster the closer you get to an obstruction.



Cruise control

Tap-up tap-down cruise control allows you to keep a steady speed without holding your foot on the throttle.

Option packs:

Interior Pack

- > Cigar lighter and ashtray
- > 12-volt electrical accessory socket in load area

Intelligence Pack

- > Multi-function trip computer
- > Rain-sensitive windscreen wipers
- > Anti-dazzle rear-view mirror
- > Automatic lighting control

Winter Pack

- > Heated seats
- > Headlight washers
- > Front fog lights

Individual options include:

- > Remote control ultrasonic security alarm system
- > Mobile phone system with Bluetooth® (does not include phone or phone-specific cradle)
- > Cruise control
- > Upper load restraint mesh
- > Flex bulkhead with fold-flat passenger's seat*
- > Air conditioning (standard on Sportive and XP models)

**Not available on Sportive or XP models*

Accessories

Genuine Vauxhall Accessories are the right choice for your Astravan. The list below is just a small sample of the range available. For a full list, please refer to the Vauxhall Commercial Vehicle Price Guide, or check out our website at: www.vauxhall.co.uk/accessories



Fixed tow bar 12N

This strong and high quality towing hitch expands the versatility and flexibility of your Astravan.



Security alarm

Remote control ultrasonic security alarm system ensures high levels of protection for your van and its cargo.



Rubber floor mats

Protect your interior from everyday wear and tear, with secure fixings and an anti-slip underside.



Rear window grille

Perforated sheet metal/mesh grille provides a strong physical barrier and a highly visible deterrent to thieves.



Mudflaps

Tailor-made rubber mudflaps protect your vehicle from salt and road grit. Set of four.



Irmischer alloy wheels

Why not personalise your Astravan with a choice of 16-, 18- or 19-inch alloy wheels available in a variety of designs.

Accessories include:

- > Base carrier
- > Cargo liner
- > Load-restraining floor net
- > MetaSystem alarm
- > MetaSystem rear parking distance sensors
- > Steering wheel security bar
- > Safety Pack (warning triangle, first aid kit and hi-visibility vest)
- > Flange tow bar with 12N, 12N/12S or 13 pin electrics

irmischer

- > Interior styling
- > Exterior body styling
- > Styling pack
- > Sports silencer
- > Alloy wheels

Colours and trims

Astravan's business-like appearance is exemplified by the choice of colours available. The cloth trims have been chosen as much for their hard-wearing properties as they have for their visual appeal.

Power Red – solid



Summit White – solid



Sovereign Silver – two-coat metallic



Technical Grey – two-coat metallic



Carbon Flash – two-coat metallic



Due to the limitations of the printing process the colours reproduced may vary from the actual colour. As a result they should be used as a guide only.

All Vauxhall Commercial Vehicle retailers have a comprehensive showroom colour display, with actual exterior paint samples available for inspection.

Please note: Certain alternative colours are available for special order on Astravan. Restrictions apply so please consult your Commercial Vehicle retailer for more details.



Silver Alpha cloth seat trim.

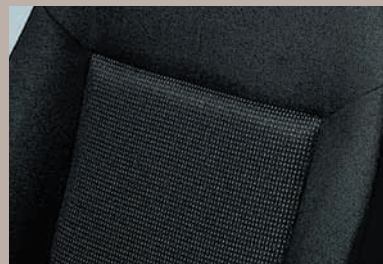

Alpha cloth trim.

	Club	Sportive	Sportive XP
Exterior colours	Alpha Cloth	Silver Alpha Cloth	Silver Alpha Cloth
Solid			
Power Red	•	•	-
Summit White	•	•	•
Two-coat metallic			
Sovereign Silver	○	•	•
Technical Grey	○	•	•
Carbon Flash	○	•	•

• = Available at no cost.

○ = Available at extra cost.

- = Not available on this model.

Vauxhall Commercial Vehicles

The wheels of your business.

Whatever your load, Vauxhall Commercial Vehicles are designed to help you deliver a top quality job. Our award-winning line-up can actively enhance the operating efficiency of your business by delivering outstanding load-carrying potential, low running costs and day-long driver comfort. Whichever Vauxhall Commercial Vehicle you choose, you can also rest assured that Vauxhall's nationwide network of retailers will go the extra mile to meet all your servicing and maintenance needs.

But why take our word for it? Vauxhall's commitment to keeping your business moving is recognised by van operators of all sizes across the length and breadth of the country...



Russell Lelliot, Managing Director, RSL Transport said...

'We've been running Movanos for years. Our two new Movanos save around 4mpg when full, compared to the old models. Which over almost 3,000 miles per week per van, is a big saving!'



Mary Wilson, Owner, Mary Wilson Flowers said...

'As well as handling like cars, our Combos are very fuel efficient – averaging over 45 mpg. That explains why we've always chosen Combo and had 14 in total.'

Mike Sinclair, Senior Property Partner, Aberdeen Considine said...

'Our fleet of 23 Corsavan Sportives is a reflection on our business, reinforcing our professional image. Not only that, we've found them economical, reliable and fun to drive.'





Andrew Cook, Rail Structures Examiner, Amey PLC, said...

'The reasons I drive Vivaro? Simple. It's comfortable, the driving position and visibility are great and it's surprisingly compact. This makes it ideal for some of the limited access situations we encounter.'

Marc Daley, Business Director, Amey PLC said...

'Amey are delighted to include the Vauxhall Astravan amongst its fleet. It has proved reliable and has gained user acceptance across a diverse range of operating environments.'



Contents

Equipment

Safety	24
Facia, instruments and controls	
Audio and communications	
Seating	25
Interior	
Security	
Load area	
Wheels and tyres	26
Exterior features	
Option packs	
Technical data	
Engines	27
Transmission ratios	
Vauxhall Assistance and warranties, transmissions, fuel tank capacity, suspension, brakes, steering and insurance groups	28
Dimensions, loadspace dimensions, loadspace volume	29
Weights and towing data	30
Fuel economy and emissions	
Glossary of terms	31

Safety

Standard features • Driver's airbag • Passenger's airbag • Electronic Stability Programme-plus (ESP-plus) with traction control (see **D1** page 31 for details) • Anti-lock Braking System (ABS) with Electronic Brakeforce Distribution (EBD) • Emergency Brake Assist (EBA) (see page 28 for details) – Increases applied brake force in emergency braking situations • Height-adjustable head restraints • Pyrotechnic body-lock seatbelt pretensioner system – Tightens the seatbelt during the early stages of a frontal impact • Seatbelt force limiters – Reduces potential upper body injuries during a frontal impact • Height-adjustable inertia-reel seatbelts • Anti-submarining ramps in all seats – Help prevent occupants sliding underneath the lap belt during a collision • Energy-absorbing steering column • Pedal release system – Reduces potential injury to the driver's legs and feet during a severe frontal impact • Laminated windscreen • Side-impact protection beams • Reinforced passenger safety cell

Additional feature	Club	Sportive	Sportive XP
Side-impact airbags	○	○	○

Facia, instruments and controls

Standard features • Matt chrome-effect centre console • Trip odometer • Rev counter • Multi-function display showing time, date and outside air temperature (with ice warning function) • Steering column adjustable for reach and rake • Service-due indicator • Instrument panel light dimmer • Handbrake-on/low brake fluid level and low fuel level warning lights

Additional features	Club	Sportive	Sportive XP
Charcoal-effect inserts on facia and doors	●		
Maze chrome-effect inserts on facia and doors		●	●
Matt chrome-effect edging on instrument dials		●	●
Three-spoke leather-covered sports steering wheel		●	●
Multi-function trip computer – provides instantaneous and average fuel consumption, fuel consumed, average speed, distance travelled and range based on fuel remaining	□	□	□
Cruise control	○	○	○

Audio and communications

Features	Club	Sportive	Sportive XP
CD player/stereo radio (CD 30) • CD player • AM/FM stereo radio with 24 station presets • RDS with Traffic Programme • Remote display • Four speakers	●	●	●
Steering wheel mounted audio controls	○	●	●
Mobile phone system with Bluetooth® and steering wheel mounted audio controls (does not include phone or phone-specific cradle)	○	○	○
Roof-mounted flexible aerial	●	●	●

Seating

Standard feature • Height-adjustable driver's seat with reach and recline adjustment

Additional features

	Club	Sportive	Sportive XP
Fold-flat passenger's seat back	○		
Sports seats with lumbar and height adjustment		●	●
Map pockets on seat backs		●	●
Heated seats	□	□	□

Interior

Standard features • Fade up/fade down courtesy lighting operated by door switches • Illuminated lidded glovebox • Twin sunvisors and dipping rear-view mirror • Door armrests • Door pockets • Carpeted cabin area • Air blend heater with four-speed fan

Additional features

	Club	Sportive	Sportive XP
Air conditioning	○	●	●
Map reading lights		●	●
Electro-chromatic anti-dazzle rear-view mirror	□	□	□
Cigar lighter and ashtray	□	□	□
12-volt electrical accessory socket in load area	□	□	□

Security

Standard features • Remote control central deadlocking (doors, tailgate and fuel filler flap) • Visible Vehicle Identification Number (VIN) plate • 'Key left in ignition' audible warning • Freewheeling door locks • Electronic engine deadlock immobiliser • Electronic theft protection for audio equipment

Additional features

	Club	Sportive	Sportive XP
Folding key		●	●
Remote control ultrasonic security alarm system	○	○	○

Load area

Standard features • Glazed tailgate • Half-height steel bulkhead • Loadspace sidewall half-height protection panelling • Load restraint lashing eyes (six) • Under load floor storage • Illuminated load area • Load area rubber floor mat

Additional features

	Club	Sportive	Sportive XP
Upper load restraint mesh	○	○	○
Flex bulkhead with fold-flat passenger's seat	○		



Steering wheel mounted audio controls.



Upper load restraint mesh.

- = Standard equipment.
- = Optional at extra cost.
- = Only available as part of an option pack.



17-inch alloy wheel (Sportive XP model).



Rain-sensitive windscreen wipers.

Wheels and tyres

Features	Club	Sportive	Sportive XP
15-inch steel wheels with 195/65 R 15 low profile tyres and flush wheel covers – 1.7CDTi 16v (110PS)	●		
16-inch steel wheels with 205/55 R 16 low profile tyres and flush wheel covers – 1.7CDTi 16v (125PS)	●		
16-inch Structure wheels with 205/55 R 16 low profile tyres (non-Structure, steel spare wheel)		●	
17-inch alloy wheels (steel spare) with 215/45 R 17 low profile tyres			●
Tyre inflation kit in lieu of spare wheel	N/C	N/C	N/C

Exterior features

Standard features • Electrically operated windows with safety autoreverse and one-touch facility • Green-tinted glass • Heated rear window with automatic timed cut-off • Intermittent rear window wash/wipe • Windscreen wipers with variable intermittent facility and flick-wipe • Lights-on audible warning • LED centre brake light • Reversing light and rear fog light • Twin-jet windscreen washer nozzles • Twin gas-assisted tailgate and bonnet struts • Body-colour front and rear bumpers

Additional features	Club	Sportive	Sportive XP
Rain-sensitive windscreen wipers	<input type="checkbox"/>	<input type="checkbox"/>	<input type="checkbox"/>
Automatic Lighting Control (ALC)	<input type="checkbox"/>	<input type="checkbox"/>	<input type="checkbox"/>
Headlight washers	<input type="checkbox"/>	<input type="checkbox"/>	<input type="checkbox"/>
Front fog lights	<input type="checkbox"/>	<input type="checkbox"/>	●
Internally adjustable door mirrors (wide-angle on driver's side)	●		
Electrically adjustable/heated door mirrors (wide-angle on driver's side)	○	●	●
Roof rails (black on Club/Sportive, silver alloy-effect on Sportive XP)	○	●	●
Dark-tinted rear window		●	●
Body-colour door handles, door mirrors and side-protection mouldings		●	●
Exterior style pack – body-colour front lower spoiler/rear lower skirt/rear roof spoiler/side sills			●
Rear parking distance sensor	○	○	○
Increased ground clearance and sump guard for bad road usage	○		
Tow bar with seven-pin electrics	○	○	
Two-coat metallic paint	○	●	●
Special paint (restrictions apply – please consult your retailer for details)	○		

Option packs

Features	Club	Sportive	Sportive XP
Intelligence Pack • Multi-function trip computer – provides instantaneous and average fuel consumption, fuel consumed, average speed, distance travelled and range based on fuel remaining • Rain-sensitive windscreen wipers • Electro-chromatic anti-dazzle rear-view mirror • Automatic Lighting Control (ALC)	○	○	○
Winter Pack • Heated seats • Headlight washers • Front fog lights	○	○	○
Interior Pack • Cigar lighter and ashtray • 12-volt electrical accessory socket in load area	○	○	○

● = Standard equipment.

○ = Optional at extra cost.

□ = Only available as part of an option pack.

N/C = No-cost option.

Power and torque curves

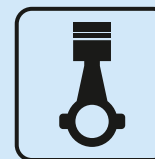
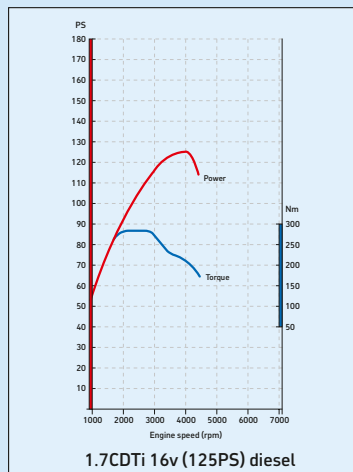
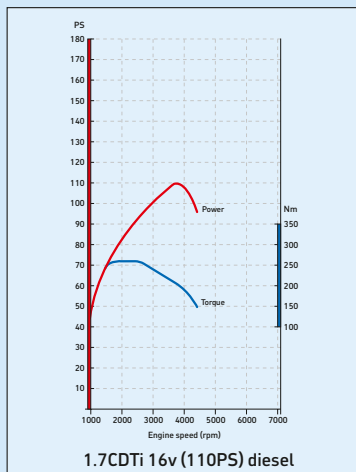

110PS/125PS

Choice of two common rail turbo diesel engines

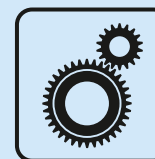

6-Speed

Six-speed manual

Engines

	1.7CDTi 16v (110PS) ECOTEC-4 Turbo diesel	1.7CDTi 16v (125PS) ECOTEC-4 Turbo diesel
Capacity	1686cc	1686cc
Maximum power	110PS (81kW) @ 3800rpm	125PS (92kW) @ 4000rpm
Maximum torque	260Nm (192 lb.ft.) @ 1700-2500rpm	280Nm (206 lb.ft.) @ 2000-2700rpm
Configuration	4 cylinders, 4 valves per cylinder, double overhead camshafts	
Fuel/induction system	Variable geometry turbocharger with intercooler. Common rail fuel injection	
Emission compliance	Euro 5 with Diesel Particulate Filter	
Service interval	20,000 miles or one-year (whichever occurs sooner)	

Transmission ratios

Manual	Gear ratios (mph/1000rpm)						Final drive ratio
	1	2	3	4	5	6	
1.7CDTi 16v Club	3.82:1 (5.2)	2.05:1 (9.8)	1.30:1 (15.4)	0.96:1 (20.8)	0.74:1 (27.0)	0.61:1 (32.8)	3.65:1
1.7CDTi 16v Sportive	3.82:1 (5.1)	2.05:1 (9.6)	1.30:1 (15.1)	0.96:1 (20.5)	0.74:1 (26.6)	0.61:1 (32.3)	3.65:1



Six-speed manual gearbox.

Vauxhall Assistance and warranties*

- All new Astravans qualify for a three-year vehicle warranty consisting of a one-year/unlimited mileage manufacturer's warranty and a second and third year manufacturer's warranty with a 60,000 miles limitation
- Vauxhall Assistance for 12 months from first registration
- Six years' body panel anti-perforation warranty

* = Warranty is only available on vehicles sourced from General Motors UK Limited. Terms and conditions apply – please see your Vauxhall retailer for details.

Transmission

- Front-wheel drive
- Six-speed manual gearbox

Fuel tank capacity

52 litres (11.4 gallons).

Suspension

Front: Independent. MacPherson struts with gas-pressure dampers and coil springs. Anti-roll bar. Hydro-formed subframe offers increased lateral stiffness. Hydraulic control arm bushing to give improved insulation from road noise.

Rear: Lightweight torsion beam rear axle with one-piece, hollow cast trailing arms. Built-in anti-roll bar. Progressive-rate double conical mini-block springs and gas-pressure dampers. Additionally XP models feature lowered sports suspension.

Brakes

- Anti-lock Braking System (ABS) with Electronic Brakeforce Distribution (EBD)
- Emergency Brake Assist (EBA)
Emergency brake assist detects the urgency with which the brake pedal is pressed and rapidly increases the pressure to the maximum the system can provide, shortening stopping distances. It also enhances pedal feel. EBA is standard on all Astravan models
- Dual circuit, diagonally split braking system
- Front brake pad wear warning

1.7CDTi 16v (110PS)

Front ventilated discs: 280mm diameter
Rear discs: 264mm diameter

1.7CDTi 16v (125PS)

Front ventilated discs: 308mm diameter
Rear discs: 264mm diameter

Steering

- Electro-hydraulic power-assisted
- Turning circle: Kerb-to-kerb Club/Sportive models – 11.10m (36.4ft.)
Sportive XP models – 11.51m (37.3ft.)

Electrics

Alternator:

1.7CDTi 16v – 100A.

Maintenance-free battery:

All models – 60Ah.

Body

- Extensive anti-corrosion protection
- Aerodynamic drag co-efficient: Cd 0.31
- Front and rear safety deformation zones

Insurance groups

Club – 3ET2

Sportive – 3ET2

Sportive XP – 4ET2

As recommended by the Association of British Insurers.

Dimensions millimetres (inches)

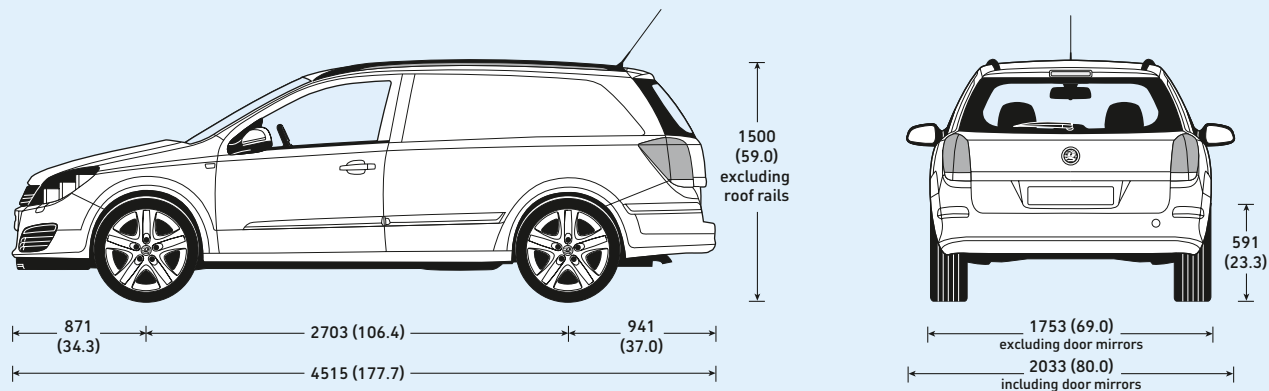

All heights are shown unladen.

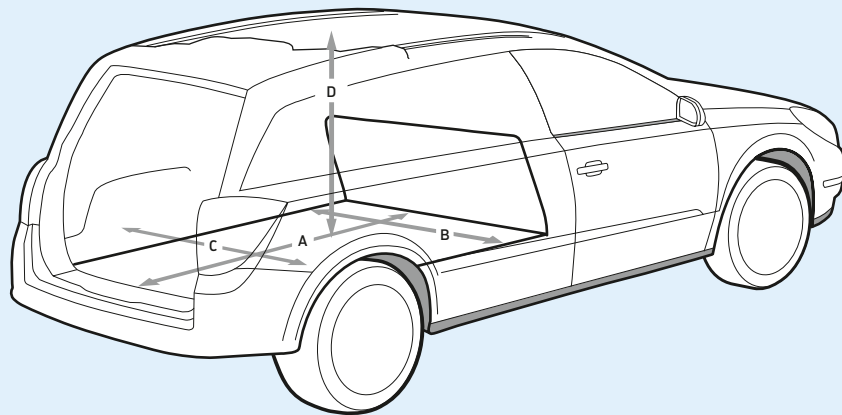

Loadspace dimensions

Maximum load length	mm (inches)
Standard vehicle (A)	1825 (71.8)
With optional Flex bulkhead	2680 (105.5)
Maximum load width	
At widest point (B)	1376 (54.2)
Between wheel arches (C)	1103 (43.4)
Maximum load height	
Standard vehicle (D)	900 (35.4)
Access dimensions	
Tailgate aperture height	766 (30.1)
Tailgate aperture width	1024 (40.3)
Flex bulkhead aperture width	531 (20.9)
Flex bulkhead aperture height	276 (10.9)
Loadspace volume	
VDA method	cu.m (cu.ft)
All models	1.58 (55.8)

Weights and towing data

Model	UK plated weights and kerbweights kg						Total Kerb	Payload kg	Towing weights Trailer with brakes (without brakes) kg	Plated Gross Combination Weights (GCW) kg
	Front axle		Rear axle		GVW					
	Plated	Kerb	Plated	Kerb						
Club										
1.7CDTi 16v (110PS) ecoFLEX	1010	826	940	464	1960	1310	650	1400 (690)	3390	
1.7CDTi 16v (125PS)	1025	841	940	464	1960	1310	650	1400 (690)	3390	
Sportive										
1.7CDTi 16v (110PS/125PS)	1025	843	940	465	1975	1328	647	1400 (690)	3390	
Sportive XP										
1.7CDTi 16v (125PS)	1060	875	940	468	1975	1328	647	1400 (690)	3390	

Note: Kerbweights for standard vehicles include coolant, oil, 90% full fuel tank and spare wheel. They will vary according to the vehicle specification (including options and accessories) with a corresponding variation in payload. **Payload** figures do not allow for the weight of the driver, or any passengers, which should therefore be deducted from the figures shown and are also subject to correct weight distribution. **Gross plated weights** (including axle weights) quoted on the vehicle plate must never be exceeded. **Roof load** should not exceed 100kg including the weight of the roof rack/carrier.



Payload

647kg-650kg

Fuel economy and emissions

Model	Fuel economy mpg (litres/100km)			CO ₂ emissions (g/km)
	Urban driving	Extra-urban driving	Combined figure	
Club 1.7CDTi (110PS) ecoFLEX	43.5 (6.5)	68.9 (4.1)	56.5 (5.0)	132
Club 1.7CDTi (125PS)	43.5 (6.5)	67.3 (4.2)	55.4 (5.1)	134
Sportive 1.7CDTi (110PS)	42.2 (6.7)	65.7 (4.3)	54.3 (5.2)	137
Sportive 1.7CDTi (125PS)	42.2 (6.7)	65.7 (4.3)	54.3 (5.2)	137
Sportive XP 1.7CDTi (125PS)	42.2 (6.7)	65.7 (4.3)	54.3 (5.2)	137

Fuel consumption and CO₂ emission data complies with the relevant EU testing regulations used by vehicle manufacturers to enable comparisons between different models. **Important:** Please note fuel consumption can be affected by many factors including driving style, road and traffic conditions, vehicle mileage and standard of maintenance. In addition these results relate to the particular vehicle tested, inevitably there will be differences between individual vehicles of the same model.

Glossary of terms

Plated weight

The maximum weight to which a vehicle or an axle may be loaded, determined either by the design of the components or by legislation. All commercial vehicles must carry a manufacturer's 'plate' showing the vehicle and axle gross 'plated weights'. It is an offence to drive a vehicle in a condition where any of these weights are exceeded.

Kerbweight

The weight of the complete vehicle in standard form, excluding payload and driver but including coolant, oil, 90% full fuel tank and spare wheel where appropriate. Kerbweights quoted in Vauxhall brochures are subject to manufacturing tolerances and to the fitment of optional equipment and accessories. Where load capacity is critical the actual kerbweight should be obtained by weighing the vehicle on a calibrated public weighbridge.

Gross Vehicle Weight (GVW)

The total permissible weight of a vehicle including payload and passengers, as shown on the manufacturer's plate.

Gross Combination Weight (GCW)

The maximum permissible weight of a vehicle, including payload and passengers, combined with the total weight of any trailer it is towing. The maximum GCW weight limit is quoted on the vehicle plate and must not be exceeded.

Payload

The total permissible weight that can be carried without exceeding the vehicle's plated weight. This can be obtained by deducting the kerbweight from the plated Gross Vehicle Weight (GVW). Please note: the payload figure does not allow for the weight of the driver or any passengers which should therefore be deducted from the figures shown and are also subject to correct weight distribution.

Maximum towing weight

The maximum weight of any trailer and its load which may be towed within the limit of the vehicle's plated Gross Combination Weight (GCW). It is based on the ability of the vehicle – at full GCW – to restart on a 12% gradient, which is approximately 1 in 8.3, at sea level. At altitudes above 1500 metres, the engine output may drop with a corresponding reduction in towing capability. It is the operator's responsibility to ensure that the trailer noseweight does not cause the rear axle plated weight of the towing vehicle to be exceeded.

Always fit Vauxhall towing attachments and accessories available from your Vauxhall Commercial Vehicle retailer. They are designed specifically for Vauxhall models and carry a 12-month warranty.

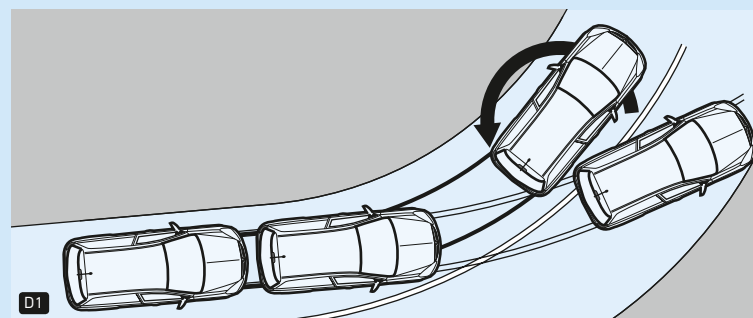

D1. Electronic Stability Programme-plus (ESP-plus)

ESP-plus provides enhanced yaw compensation during understeer or oversteer. The system works by monitoring the front and rear of the vehicle, comparing their respective directions of travel going in to the bend with the input received through the steering wheel. If the vehicle starts to slide, it applies corrective braking to the appropriate wheel, or wheels, compensating for the slide and helping you regain control more rapidly. ESP-plus offers additional safety in the form of two-way traction control, which prevents the driving wheels from spinning, under acceleration, on slippery surfaces. The system is standard on all models.

Trust Vauxhall

Protecting the environment

Vauxhall's commitment to the environment is demonstrated by our products' many environmental awards, won both through the use of more recycled materials and by becoming cleaner and more efficient. For information on Vauxhall's efforts to achieve an environmentally sustainable future, see www.vauxhall.co.uk/recycling

Fleet Customer Services

Our dedicated support services for fleet managers includes factory demonstrators and information on whole life costs, company car and van taxation and finance. For further information please call **0870 010 0651**.

Vauxhall Extended Warranty

For complete peace of mind Vauxhall offers an extended warranty that can be purchased on an annual basis following the expiry of the original new vehicle warranty. It covers most mechanical and electrical components. Terms and conditions apply. For further details please contact your local Vauxhall Commercial Vehicle retailer.



When you have finished with this brochure please recycle it

Business Lease

Business Lease, from GMAC, offers the versatility of a purchase-based finance plan, while making the most efficient use of tax and cash-flow benefits for VAT-registered business users. It's available for all Vauxhall Commercial Vehicles up to 12 months old and offers highly flexible term lengths, variable deposits and a choice of payment profiles. Ask your retailer for full details.

Business First

Available to business users only, Business First enables you to drive a new vehicle without a large, initial financial outlay. You pay to use the vehicle, not to own it. The vehicle is provided over a predetermined period, and when that period comes to an end the vehicle is returned. Ask your retailer for full details.

Servicing and maintenance

The best way to maximise the performance and reliability of your Vauxhall is to have all routine servicing and maintenance carried out at a Vauxhall Commercial Vehicle retailer. Nationwide there are over 250 light commercial vehicle retailers and a further 195 heavy commercial vehicle retailers.

In the event of an accident...

Vauxhall Accident Support helps keep you mobile following an accident. Benefits include scene-of-accident advice, message service, assistance with claims and vehicle recovery. For further details call **0800 010 304**.

Premier Service Centres

Our Premier Service Centres feature a guaranteed same day repair service (provided the parts are in stock) and an appointment-free service for diagnosis and repairs taking less than 90 minutes. All repairs are carried out within 24 hours of the diagnosis.

For more information...

For a brochure on any Vauxhall model (up to a maximum of three per caller) or location of your nearest retailer, call **0845 600 1500**.

Alternatively, details can be found on our website at: www.vauxhall.co.uk/vans

Proud Sponsor of Home Nations Football



Every effort has been made to ensure that the contents of this publication were accurate and up-to-date at the time of going to press (February 2012). Vauxhall vehicles are equipped with components manufactured by various General Motors operating units and outside suppliers. The Company reserves the right to alter specifications and withdraw products from sale without notice. Any such alterations will be notified to Vauxhall retailers at the earliest opportunity, please consult your local retailer for the latest information. The specifications detailed within this brochure are not necessarily applicable to alternative models such as Special Editions. Details of any such models will be contained in specific literature or found on the Vauxhall website. Please note that Vauxhall retailers are not the agents of General Motors UK Limited and are not authorised to bind the Company by any specific or implied undertaking or representation. It is advisable to ensure that your motor insurance policy provides adequate cover for additional fitted options and accessories. Please note accessories shown are for illustrative purposes only. As part of Vauxhall's policy of environmental care, this brochure is printed on paper manufactured using Elemental Chlorine Free pulps from specially farmed, sustainable timber resources. All rights reserved. No part of this publication may be reproduced in any form or by any means, without the prior written permission of General Motors UK Limited.

VM1209993

©2012 General Motors UK Limited

Published March 2012

General Motors UK Limited, Luton LU1 3YT

COMMERCIAL VEHICLES
The Wheels of Business



VAUXHALL