

# Vivaro

2011 Models Edition 2



Proud Sponsor of Home Nations Football



# The Wheels of Business. Helping you deliver.

Whatever your line of business, Vauxhall Commercial Vehicles can help you deliver. With five different models – including New Corsavan and the award-winning New Movano – we offer a massive choice of over 230 variants including panel vans, chassis cabs,

chassis crew cabs, platform cabs, tippers, dropsides, box vans and passenger carriers. We're also committed to keeping your business moving. That means reliable, fuel-efficient vehicles – including our new ecoFLEX range – supported by a dedicated network of over





450 retailers offering the expert support and back-up you need. We build more commercial vehicles at our British production facilities at Ellesmere Port and Luton than any other UK manufacturer. We've also won over 30 industry awards since 2001 – major awards,

presented by some of the toughest judges in the business. Introduce the in-built reassurance of the Vauxhall brand and it's easy to see why Vauxhall Commercial Vehicles really are 'The Wheels of Business'.





06 Access  
08 Loadspace  
10 Payloads  
12 Interior, safety and security

14 Cabin comfort  
16 Power and efficiency  
18 Sportive  
20 Doublecab

22 Sportive Doublecab  
24 Conversions  
26 Options and accessories  
28 Colours and trims

30 Customer advocacy  
32 Equipment and Technical Data



# Vivaro. Spends more time on the road.

Big on style, big on performance and big on the kind of features that take the hard graft out of everyday working life, Vivaro continues to define the standard by which all medium vans are judged.

Visually, the UK-built Vivaro makes a clear statement of professional intent, our Sportive models, in particular, benefitting from front fog lights, 16-inch alloy wheels, body-colour rear light mouldings and door mirror housings.

Inside, Vivaro is as functional as ever, with a stylish yet practical fascia, superb ergonomics and a host of intelligent storage facilities.

Under the bonnet, the fuel-efficient common rail turbo diesel line-up comprises cost-effective 90PS and 115PS 2.0CDTI 16v units and a powerful 146PS 2.5 CDTI 16v engine. The range now includes a choice of specially developed ecoFLEX models that boast some of the lowest CO<sub>2</sub> emissions in their class.

Add 20,000 mile/one-year service intervals, a choice of standard or high roof panel van models, a versatile 9-seat Combi derivative plus our dropside version – and here's a range that continues to build on a remarkable track record.

Some of the vehicles shown in this brochure include options and accessories available at extra cost. And not all of the features described are available on every model. So please check the equipment and technical data section for further details. From time to time, we also offer alternative models such as Special Editions which are featured in separate literature or can be found on the Vauxhall website: [www.vauxhall.co.uk/vans](http://www.vauxhall.co.uk/vans)

Short wheelbase Sportive model illustrated.

# Access

Making multiple drops and deliveries in tight spaces can make access a problem. Fortunately this is where Vivaro really does excel. The twin rear doors can be swung clear to 165° and locked in place at 90° to provide safe, convenient loading, even where space is at a premium. For unhindered access when reversing back to a doorway, long wheelbase, standard roof models can also be specified with optional 250° opening rear doors (glazed or unglazed). Or specify an optional high lift tailgate with heated rear window complete with wash/wipe facility, available on all standard roof models, thereby offering some protection from the elements when working at the back of the vehicle.

Vivaro comes with a one-metre wide nearside sliding side-access door as standard, with an offside sliding side-access door available at extra cost. Both doors can easily accommodate a standard Euro pallet, the flat load floor ensuring easy forklift access.

## Features include:\*

- › Nearside sliding side-access door
- › Offside sliding side-access door (optional)
- › Full-height steel bulkhead
- › Unglazed rear doors
- › Glazed rear doors (optional)
- › Tailgate with heated window and wash/wipe facility (optional)
- › Load restraint lashing eyes
- › Illuminated load area



Access and loading is easy through the nearside, and optional offside, sliding side-access doors.





*Long wheelbase standard roof model illustrated features optional offside sliding side-access door and glazed rear doors with heated rear windows and wash/wipe facility.*





*Short wheelbase model illustrated features optional offside sliding side-access door and glazed rear doors.*





## Loadspace

With its two wheelbase and two roof height permutations, Vivaro makes it easy for you to get the right van for the job. With a maximum load floor length of 2815mm, the Vivaro long wheelbase high roof model offers a substantial 8.4 cubic metres of loadspace volume and 526mm of extra height compared to the standard roof model. All models feature full-height unglazed rear doors – plus a full-height steel bulkhead to further enhance safety and security. Alternatively, a driver's full-height steel load restraint mesh guard can be specified at no extra cost in lieu of the bulkhead.

Loadspace dimensions	mm	inches
Maximum load floor lengths	2415-2815	95.1-110.8
Maximum load area width	1663	65.5
Maximum load area heights	1387-1913	54.6-75.3
Width between wheel arches	1268	49.9
Maximum rear door aperture heights	1320-1818	52.0-71.6
Rear door aperture width (at floor)	1390	54.7
Loading heights (unladen)	542-549	21.3-21.6
Sliding side-access door aperture height	1285	50.6
Sliding side-access door aperture width	1000	39.4
<b>Loadspace volume</b>	<b>cu.m</b>	<b>cu.ft</b>
Maximum loadspace volumes (VDA method)	5.0-8.4	177-297







# Payloads

Vivaro offers a choice of loadspace volumes. But sometimes it's payload, not dimensions, that counts – that's why Vivaro boasts a range of payloads from 1016kg to 1271kg. The rear suspension set-up uses progressive-rate springs and gas-pressure dampers which adapt to the vehicle load, resulting in superb roadholding and a smooth, reassuring ride. All Vivaro engines and transmissions are up to the task of shifting even the heaviest of loads. And if you're regularly carrying a full cargo or towing, you can choose a more powerful, 2.5CDTI 16v (146PS) common rail turbo diesel – guaranteed to make light work of long distance haulage.



Optional FlexxCargo anchorage system makes light work of securing loads.

Model	kg
2700 SWB standard roof	1016-1100
2900 SWB standard roof	1252-1256
2900 LWB standard roof	1164-1271
2900 SWB high roof	1168-1173
2900 LWB high roof	1206-1213

# Cabin

As existing drivers will testify, Vivaro's interior raises the bar for vans in this class. There's the stylishly appointed facia and centre console – creating the perfect driving environment. An effect that's set off by hard-wearing cloth or grey vinyl seat trim.

Safety and security levels are high too, thanks to the fitment of a full-height steel bulkhead as standard\*. Not to mention plenty of storage space for all your drinks, bags, CDs and other stuff.



## CD player

The standard CD 10 audio system features MP3 format and an auxiliary-in socket.



## Steering column audio controls

Standard on all Vivaro models, enabling you to operate audio functions.



## Intelligent storage

Moulded recesses above the glovebox and centre console create useful additional storage space.



## Features include:\*\*

- › CD player with MP3 format/stereo radio (CD 10 MP3)
- › Steering column mounted audio controls
- › Auxiliary-in socket
- › Electrically operated front windows
- › 12-volt electrical accessory socket
- › Driver's airbag
- › ABS with Emergency Brake Assist
- › Remote control central deadlocking
- › Electronic engine deadlock immobiliser

## Options include:\*\*

- › Front passengers' twin airbag
- › Electronic Stability Programme-plus with traction control
- › Selective door locking
- › Remote control ultrasonic security alarm system

\*Bulkhead can be replaced with full-height steel load mesh restraint guard behind driver at no extra cost.

\*\*Not all features and options are available on every model. Please see pages 32-36 for details.





Interior, safety and security

Vehicle illustrated features optional audio unit with Bluetooth® connectivity.







## Comfort

Vivaro models are seriously well equipped. But the real beauty of Vauxhall's Luton-built range is the way in which it allows you to upgrade your own particular model to create a workspace that is 100% in tune with the needs of your company – and your drivers. Vivaro options, for example, cover a broad spectrum of features that span sophisticated audio upgrades and improved cabin ergonomics. We also offer a range of high value option packs. The equipment and technical data section (see page 32 onwards) has all the details.



**Single front passenger seat option**  
Includes lumbar adjustment and armrests for both driver and passenger.



**Optional cruise control**  
Helps you keep to prevailing speed limits and can also help improve fuel economy.



**Satellite navigation**  
Optional TomTom-based system features a useful dash mounted/hand-held remote control unit.



**Optional USB facility**  
Allows you to view iPod™ functionality via the audio display.

### Features include:\*

- > Dual front passengers' bench seat
- > Six-way adjustable driver's seat
- > Steering column adjustable for reach
- > Illuminated glovebox
- > Facia-mounted gear lever

### Options include:\*

- > Driver's seat and single front passenger's seat with lumbar adjustment and armrest
- > Air conditioning
- > Satellite navigation/CD player with MP3 format/stereo radio/auxiliary-in socket/Bluetooth® connectivity (CD 30 BT NAVI)
- > Cruise control
- > Driver's seat armrest

*\*Not all features and options are available on every model. Please see pages 32-36 for details.*





## Power and efficiency

With a choice of highly efficient, common rail turbo diesel engines and a 90-litre fuel tank, Vivaro is designed to spend more time on the road. All three engines – 2.0CDTI 90PS, 2.0CDTI 115PS and range-topping 2.5CDTI 146PS – combine strong power output with high flexibility and impressive fuel economy. Indeed, in October 2009, Vivaro scooped top spot for commercial vehicles in the ALD Automotive/TOTAL ECO 10 MPG Marathon, averaging an incredible 55.25mpg over a 360 mile trip.



Based on our short wheelbase, standard roof, 2.0CDTI panel van model, the new Vivaro ecoFLEX variants embody all the benefits of Vauxhall's ecoFLEX philosophy.

With subtle changes to the vehicles' specification – alongside fitment of a 62mph fixed speed limiter – the new models have been specifically developed to reduce CO<sub>2</sub> emissions and increase average fuel economy. Indeed, CO<sub>2</sub> is a highly competitive 185g/km – some 5% lower than the standard model.

Four versions are available, offering a choice of 90PS and 115PS power outputs and two GVWs: 2700kg and 2900kg. Vauxhall is now the only CV manufacturer to offer 'eco' versions across its entire line-up.

### Hard working

20,000 mile/one-year service intervals, a 'long-lasting' stainless steel exhaust system and a three-year warranty mean more earning time – and less downtime.

Matched with a smooth-shifting six-speed manual gearbox or our innovative six-speed Tecshift transmission, Vivaro is well up to the tasks faced by a modern commercial vehicle.



### Tecshift

Combines the main features and flexibility of a regular automatic gearbox with the performance and control of manual gear selection.

### Choice of engines:

- > 2.0CDTI 16v (90PS)
- > 2.0CDTI 16v (115PS)
- > 2.5CDTI 16v (146PS)

### Features include:\*

- > Six-speed manual gearbox
- > 90-litre fuel tank

### Options include:\*

- > Six-speed Tecshift transmission
- > Engine-driven power take-off
- > Speed limiter

*\*Not all features and options are available on every model. Please see pages 32-36 for details.*

# Sportive

Vivaro Sportive models combine added driver comfort with a uniquely sporty style, set off by a host of exterior enhancements that include front fog lights, smart 16-inch alloy wheels, body-colour rear light mouldings and door mirror housings. Sportive scores top marks on the equipment front, too – most notably the brilliant CD 30 BT CD player with Bluetooth® functionality, MP3 playback and stereo radio, complete with remote display and auxiliary-in socket.



**Alloy-effect detailing**  
Smart, alloy-effect detailing for gear lever and door handles.



**Bluetooth® connectivity**  
Makes mobile phone communication hands-free and safe.



**Optional cruise control**  
Also includes leather-covered steering wheel.



**Alloy wheels**  
Distinctive 16-inch alloy wheels provide an additional style accent.

## Additional features over standard model include:

- › CD player with MP3 format/stereo radio/Bluetooth® (CD 30 BT)
- › Air conditioning
- › Electrically operated windows
- › Electrically adjustable/heated door mirrors
- › Remote control ultrasonic security alarm system
- › 16-inch five-spoke alloy wheels
- › Front fog lights
- › Metallic or pearlescent paint
- › Body-colour lower front, rear and rear quarter bumpers
- › Body-colour side-protection mouldings
- › Driver's seat with lumbar adjustment and armrest
- › Alloy-effect gear lever insert and door release
- › Instruments with chrome-effect edging



*Short wheelbase standard roof Sportive model illustrated.*









## Doublecab

Providing practical and comfortable crew transport, the Vivaro Doublecab matches six-seat capacity with great loadspace (up to 4.2 cubic metres) and high payloads (up to 1148kg). Vivaro Doublecab is available with a standard roof in short and long wheelbase versions.

All Doublecab models feature a specially contoured rear bench seat for three passengers – all with height-adjustable head restraints and lap and diagonal seatbelts.



### Rear bench seat

The sculpted rear bench seat accommodates three passengers in comfort.

Two sliding side-access doors – complete with sliding windows – ensure easy passenger access, while the high-strength, full-height ABS plastic bulkhead on all versions has an integral window for increased visibility.

Rear seat passengers benefit from excellent leg room and seat backs that are raked for comfort.



### Recessed bulkhead

The windowed bulkhead has been cleverly recessed to maximise load floor length.



### Wide opening rear doors

Optional 250° opening twin rear doors provide safe and convenient loading, even where access is restricted.

### Features include:\*

- > Dual passengers' front bench seat
- > Three-passenger rear bench seat
- > Six inertia-reel lap and diagonal seatbelts
- > Full-height integral ABS rigid plastic bulkhead with window
- > Nearside and offside sliding side-access doors with sliding windows
- > Unglazed rear doors (90°/165° opening)

### Options include:\*

- > Glazed or unglazed rear doors (250° opening)
- > Tailgate with heated window and wash/wipe facility

\*Not all features and options are available on every model. Please see pages 32-36 for details.

# Sportive Doublecab

Great for business – and equally at home when you need to transport the local five-a-side team to that crucial away match – Vivaro Sportive Doublecab models add a stylish dimension to work and leisure. Combining all of the established Vivaro Doublecab virtues – a choice of short or long wheelbase models, highly usable loadspace, superb ease of access and full six-seater capacity – with enhanced styling accents and a host of added comfort features.



Loadspace volumes and payloads remain impressive with up to 4.2cu.m and 1111kg respectively.



With six seats and six inertia-reel lap and diagonal seatbelts fitted to every model, Sportive Doublecab carries workmates – and team members – in safety and style.

## Additional features over standard Doublecab model include:

- › CD player with MP3 format/stereo radio/Bluetooth® (CD 30 BT)
- › Air conditioning
- › Electrically operated front windows
- › Electrically adjustable/heated door mirrors
- › Remote control ultrasonic security alarm system
- › 16-inch five-spoke alloy wheels
- › Front fog lights
- › Body-colour lower front, rear and rear quarter bumpers
- › Body-colour side-protection mouldings
- › Driver's seat with lumbar adjustment and armrest
- › Leather-covered steering wheel
- › Alloy-effect gear lever insert and door release
- › Instruments with chrome-effect edging



*Long wheelbase Sportive Doublecab model illustrated.*











# Vauxhall Conversions

Vivaro provides the perfect base for a wide variety of specialist body conversions. Or choose from factory-built core conversions like the Vivaro Combi.

Because Vivaro core conversions are engineered and developed using specific, in-house expertise, they come with a full and comprehensive Vauxhall three-year/100,000 mile warranty – a warranty that extends to both the cab and the conversion.



**Access platform vans**  
Specifically designed for use without stabilisers.



**Wheelchair-accessible vehicles**  
Feature two sliding side-access doors and a manually folding rear-access ramp.



**9-seat Combi**  
Delivers practical solutions to a variety of transport applications.

## Conversions include:

### Core conversions:

- > Dropside (illustrated far left)
  - 5.6sq.m load area
  - Lightweight, anodised aluminium drop-sides and tailboard
  - Underfloor storage compartments
- > 9-seat Combi
  - Short or long wheelbase
  - Second row split-folding rear seat
  - Full-length headlining and half-height panelling

### Recognised conversions:

- > Temperature controlled vehicles
- > Vehicle-mounted access platforms
- > Wheelchair-accessible vehicles

# Options

Vauxhall options and accessories are all about choice – selecting your Vivaro model then personalising it to suit the way you work. There's a range of factory-fitted options and option packs. We also offer a huge selection of Genuine Vauxhall Accessories – all designed to the same exacting standards as the vehicle itself. For further information please speak to your Vauxhall Commercial Vehicle retailer. See pages 32 onwards for option availability.



## Cruise control\*

Also includes leather-covered steering wheel on Sportive models.



## Rear parking distance sensors

Provide an audible warning to help prevent accidental damage when reversing.



**High lift tailgate with heated window and wash/wipe facility**  
Optional on standard roof models.



## Optional USB facility

Allows you to view iPod™ functionality via the audio display.

## Option packs:

### Vision Pack

- › Rain-sensitive windscreen wipers
- › Automatic Lighting Control (ALC)
- › Front fog lights\*\*
- › Selective door locking
- › Electric Pack\*\* (see below)

### Electric Pack\*\*

- › Electrically operated front windows
- › Electrically adjustable/heated door mirrors

### Smoker Pack

- › Cigar lighter and ashtray

## Individual options include:

- › CD player with MP3 format/stereo radio/Bluetooth® (CD 30 BT)\*\*
- › Air conditioning\*\*
- › Remote control security alarm\*
- › Single passenger seat
- › Front passenger airbag\*
- › FlexxCargo anchorage
- › Offside sliding door
- › Tow bar with seven-pin electrics
- › Power take-off
- › Tailgate

\*Mandates Electric Pack.

\*\*Standard on Sportive.



# Accessories

Genuine Vauxhall Accessories are the right choice for your Vivaro, allowing you to tailor your van to your individual needs; all fitted by trained Vauxhall professionals. The list below is just a small sample of the range available. For a full list, please refer to the Vauxhall Commercial Vehicle Price Guide or check out our website at [www.vauxhall.co.uk/accessories](http://www.vauxhall.co.uk/accessories)



## Carrier system

The base roof carrier system can be fitted with a steel roof rack complete with loading roller. A steel loading ladder and roof rack walkway are also available.

## Other accessories include:

### Towing

- › Flange tow bar with 12N electrics
- › Jaw and pin coupling – for use with flange tow bar
- › Detachable tow bar

### Interior – Load Area

- › Cargo liner<sup>†</sup>
- › Anti-slip mat (915mm x 915mm)
- › Load-restraining floor net
- › Interior lining plywood panels

### Interior – Cabin Area

- › Rubber floor mats
- › Seat covers
- › Underseat storage tray<sup>††</sup>

### Exterior

- › Protective rear door mouldings
- › Protective wheel arch mouldings
- › Door wind deflectors

### Safety

- › Fire extinguisher
- › Temporary tyre inflation kit

### Safety Pack

- › First aid kit with warning triangle and hi-visibility vest

### Security

- › MetaSystem alarm
- › Steering wheel security bar
- › Rear door window grilles<sup>‡</sup>
- › One-way visibility microline security window film (pair)<sup>‡</sup>

**irmischer**

- › Alloy wheels
- › Sports silencers

<sup>†</sup>SWB with nearside sliding side-access door only.  
<sup>††</sup>Single passenger seat options only.  
<sup>‡</sup>Twin rear door models only.

# Colours and trims

Vivaro's business-like appearance is exemplified by the impressive choice of colours available. The cloth or vinyl trims have been chosen as much for their hard-wearing properties as they have for their visual appeal.

Corn Yellow – solid



Flame Red – solid



Glacier White – solid



Ink Blue – solid



Ocean Green – metallic



Sage – metallic



Star Silver – metallic



Steel Grey – metallic



Adria – pearlescent



Midnight Black – pearlescent



Panorama Blue – pearlescent



Winterwind – pearlescent







**Dark Grey Punch cloth**  
Hard-wearing Dark Grey Punch cloth trim is fitted as standard across the range.

**Grey vinyl**  
Alternatively, Grey vinyl trim can be specified at no extra cost for customers requiring a more workmanlike, wipe-clean option.

	Vivaro	Vivaro Sportive
<b>Exterior colours</b>	Dark Grey Punch cloth trim*	Dark Grey Punch cloth trim
<b>Solid</b>		
Corn Yellow	●	-
Flame Red	●	-
Glacier White	●	●
Ink Blue	●	-
<b>Two-coat metallic</b>		
Ocean Green	○	-
Sage	○	-
Star Silver	○	●
Steel Grey	○	●
<b>Two-coat pearlescent</b>		
Adria	○	-
Midnight Black	○	●
Panorama Blue	○	-
Winterwind	○	●

● = Available at no cost.

○ = Available at extra cost.

- = Not available on this model.

\* = Vinyl seat trim is optional at no extra cost on panel van only.

*Due to the limitations of the printing process, the colours reproduced may vary from the actual colour. As a result they should be used as a guide only. All Vauxhall Commercial Vehicle retailers have a comprehensive showroom colour display, with actual exterior paint samples available for inspection. Please note: Certain alternative colours are available for special order on Vivaro. Restrictions apply so please consult your Commercial Vehicle retailer for more details.*

# Vauxhall Commercial Vehicles

## The wheels of your business.

Whatever your load, Vauxhall Commercial Vehicles are designed to help you deliver a top quality job. Our award-winning line-up can actively enhance the operating efficiency of your business by delivering outstanding load-carrying potential, low running costs and day-long driver comfort. Whichever Vauxhall Commercial Vehicle you choose, you can also rest assured that Vauxhall's nationwide network of retailers will go the extra mile to meet all your servicing and maintenance needs.

But why take our word for it? Vauxhall's commitment to keeping your business moving is recognised by van operators of all sizes across the length and breadth of the country...



**Russell Lelliot, Managing Director, RSL Transport said...**

*'We've been running Movanos for years. Our two New Movanos save around 4mpg when full, compared to the old models. Which over almost 3,000 miles per week per van, is a big saving!'*



**Mary Wilson, Owner, Mary Wilson Flowers said...**

*'As well as handling like cars, our Combos are very fuel efficient – averaging over 45 mpg. That explains why we've always chosen Combo and had 14 in total.'*

**Mike Sinclair, Senior Property Partner, Aberdeen Considine said...**

*'Our fleet of 23 Corsavan Sportives is a reflection on our business, reinforcing our professional image. Not only that, we've found them economical, reliable and fun to drive.'*







*Andrew Cook, Rail Structures Examiner, Amey PLC said...*

*'The reasons I drive Vivaro? Simple. It's comfortable, the driving position and visibility are great and it's surprisingly compact. This makes it ideal for some of the limited access situations we encounter.'*

*Tony Carrea,  
Fleet Manager, SDC said...*

*'We particularly like the Astravan 1.3CDTi 16v engine – it's been a big success. It's good to drive... and low CO<sub>2</sub> emissions are a big consideration to us'*



## Contents

### Equipment

Safety	32
Facia, instruments and controls Seating	
Interior features	33
Mechanical Security	
Load area	34
Wheels and tyres	
Exterior features	35
Option packs	
Audio, communication and navigation	36
<b>Technical data</b>	
Power and torque curves	37
Engines Transmission ratios	
Vauxhall Assistance and warranties, transmissions, steering, suspension, brakes, electrics, body, fuel tank capacity and insurance groups	38
Glossary of terms	39
<b>Dimensions and weights</b>	
Panel van: Exterior/interior dimensions, loadspace volumes and ground clearance	40
Panel van: Weights and towing data	41
Doublecab: Exterior/interior dimensions and loadspace volumes	42
Doublecab: Weights and towing data Fuel economy and emissions	43

## Safety

**Standard features** • Driver's airbag • Anti-lock Braking System (ABS) with Electronic Brakeforce Distribution (EBD) • Emergency Brake Assist (EBA) – Increases applied brake force in emergency braking situations • Height-adjustable padded head restraints • Three inertia-reel lap and diagonal seatbelts (doublecab – six) • Height-adjustable outer front seatbelts • Pyrotechnic body-lock front seatbelt pretensioner system – Tightens the seatbelt during the early stages of a frontal impact • Front seatbelt force limiters – Reduces potential upper body injuries during a frontal impact • Anti-submarining ramps in front seats – Help prevent occupants sliding underneath the lap belt during a collision • Side-impact protection beams • Laminated windscreen

<b>Additional features</b>	ecoFLEX Panel van	Panel van	Sportive	Doublecab	Sportive Doublecab
Front passengers' twin airbag	○ <sup>1</sup>	○ <sup>1</sup>	○	○ <sup>1</sup>	○
Electronic Stability Programme - plus (ESP-plus) with traction control <sup>2</sup>	○ <sup>1</sup>	○ <sup>1</sup>	○	○ <sup>1</sup>	○

## Facia, instruments and controls

**Standard features** • Facia-mounted gear lever • Steering column adjustable for reach • Matt chrome-effect instrument rings • Trip odometer • Rev counter • Fuel gauge with low fuel level warning light • Engine oil level indicator • Service-due indicator • Digital clock with automatic RDS time adjustment • 12-volt electrical accessory socket • Illuminated glovebox • Open storage compartment above glovebox (deleted if optional front passengers' twin airbag is fitted) • Extensive facia storage • Facia-mounted drinks holders • Facia-mounted bag-carrying hook

<b>Additional features</b>	ecoFLEX Panel van	Panel van	Sportive	Doublecab	Sportive Doublecab
Multi-function trip computer (provides information on fuel used, overall distance, average and instantaneous fuel consumption, remaining range, distance before service and average speed. Plus additional driver information messages as detailed in the owner's manual)			●		●
Digital tachograph (must be specified at time of ordering) <sup>3</sup>	○ <sup>1</sup>	○ <sup>1</sup>	○	○ <sup>1</sup>	○
Cruise control <sup>4</sup>		○ <sup>1</sup>		○ <sup>1</sup>	
Leather-covered steering wheel with cruise control <sup>4</sup>			○		○

## Seating

**Standard features** • Punch cloth seat trim • Driver's seat height adjuster • Driver's seat adjustable for reach and rake • Dual front passengers' bench seat

<b>Additional features</b>	ecoFLEX Panel van	Panel van	Sportive	Doublecab	Sportive Doublecab
Vinyl seat trim	N/C	N/C			
Height-adjustable driver's seat with lumbar adjustment and armrest <sup>5</sup>	○	○	●	○	●
Height-adjustable driver and single passenger seat with lumbar adjustment and armrest <sup>5</sup>	○	○	○	○	○
Three-passenger rear bench seat				●	●



## Interior features

**Standard features** • Vinyl floor covering in cabin area • Twin sunvisors • Air blend heater with four-speed fan • Four adjustable face-level heating and ventilation outlets • Windscreen and front side-window demist vents • Air recirculation system • Overhead storage shelf (high roof only) • Two bulkhead-mounted coat hooks • Fade down cabin area courtesy light • Door armrests • Front door pockets with bottle holder

<b>Additional features</b>	ecoFLEX Panel van	Panel van	Sportive	Doublecab	Sportive Doublecab
Air conditioning <sup>6</sup>	○	○	●	○	●
Alloy-effect gear lever insert and interior release for front doors			●		●
Cigar lighter and front ashtray	□	□	□	□	□

## Mechanical

**Standard features** • Six-speed manual gearbox • Power-assisted steering

<b>Additional features</b>	ecoFLEX Panel van	Panel van	Sportive	Doublecab	Sportive Doublecab
Tecshift six-speed transmission with sequential manual gearshift and automatic mode (2.0CDTI 1.6v (115PS) and 2.5CDTI 1.6v only) <sup>2,6</sup>		○	○	○	○
Engine-driven power take-off provision (2.0CDTI 1.6v (115PS)/2.5CDTI 1.6v only)	○ <sup>6</sup>	○ <sup>6</sup>			
Speed limiter – choice of three: 56mph (90km/h), 62mph (100km/h) or 68mph (110km/h) <sup>7</sup>	● <sup>8</sup>	○	○	○	○
Tow bar with seven-pin electrics		○	○	○	○

## Security

**Standard features** • Remote control central deadlocking (doors, tailgate – when specified, and fuel flap) with internal switch • Electronic theft protection for audio equipment • Electronic engine deadlock immobiliser • 'Key left in ignition' audible warning • Visible Vehicle Identification Number (VIN) • Steering column lock • Freewheeling door and steering lock cylinders

<b>Additional features</b>	ecoFLEX Panel van	Panel van	Sportive	Doublecab	Sportive Doublecab
Remote control ultrasonic security alarm system <sup>1</sup>	○	○	●	○	●
Selective door locking key	□	□	□	□	□



Matt chrome-effect instrument rings.

- = Standard equipment.
- = Optional at extra cost.
- N/C = No-cost option.
- = Only available as part of an extra-cost option pack – see page 35 for more details.

- 1 = Mandates Electric Pack (at extra cost).
- 2 = ESP-plus not available with Tecshift models.
- 3 = CD player/stereo radio (CD 10) fitted to Sportive models when the tachograph option is specified. Digital tachograph is not available with optional audio units. The digital tachograph option must be specified at time of ordering as it cannot be fitted retrospectively and requires calibration at an approved tachograph centre within 14 days of the vehicle's registration. **Please note:** The legislation regarding the use of tachographs is complex and operators should seek independent advice or speak to the CV specialist within a Vauxhall Commercial Vehicle retailer to ensure compliance. Alternatively your local DVLA office will also be able to provide clarification of the relevant legislation.
- 4 = Not available in conjunction with speed limiter.
- 5 = Not available in conjunction with vinyl seat trim.
- 6 = Engine-driven power take-off option not available in conjunction with air conditioning or Tecshift.
- 7 = Not available in conjunction with cruise control.
- 8 = ecoFLEX models are fitted with a 62mph (100km/h) speed limiter as standard.



Tailgate with heated window and wash/wipe facility (optional).



16-inch five-spoke alloy wheels.

## Load area

**Standard features** • Nearside sliding side-access door • Illuminated load area • Load restraint lashing eyes  
• Unglazed rear doors (90°/165° opening)

<b>Additional features</b>	ecoFLEX Panel van	Panel van	Sportive	Doublecab	Sportive Doublecab
Full-height steel bulkhead without window	●	●	●		
Full-height steel bulkhead with window	○	○	○		
Full-height steel load restraint guard behind driver	N/C	N/C	N/C		
Full-height ABS plastic bulkhead with window				●	●
Resin-coated wooden load floor covering	○	○	○		
FlexxCargo anchorage	○	○	○	○	○
Delete standard nearside sliding side-access door <sup>9</sup>	○	N/C			
Offside sliding side-access door		○	○		
Fixed window in nearside sliding side-access door <sup>10</sup>	○	○	○		
Sliding window in nearside sliding side-access door <sup>10</sup>		○	○		
Offside sliding side-access door with fixed windows to both nearside and offside doors <sup>10</sup>		○	○		
Offside sliding side-access door with sliding windows to both nearside and offside doors		○ <sup>10</sup>	○ <sup>10</sup>	●	●
Glazed rear doors (90°/165° opening) <sup>11</sup>	○	○			
Glazed rear doors with heated windows and wash/wipe facility (not with 250° opening glazed rear door option)	○ <sup>11</sup>	○ <sup>11</sup>	○ <sup>11</sup>	○	○
250° opening unglazed rear doors (LWB standard roof only)		○	○	○	○
250° opening glazed rear doors (LWB standard roof only)		○ <sup>11</sup>	○ <sup>11</sup>	○	○
Tailgate with heated window and wash/wipe facility (standard roof only)	○ <sup>11</sup>	○ <sup>11</sup>	○ <sup>11</sup>	○	○

## Wheels and tyres

<b>Features</b>	ecoFLEX Panel van	Panel van	Sportive	Doublecab	Sportive Doublecab
16-inch steel wheels with full-diameter flush covers and 195/65 R 16 tyres (2700 2.0CDTI 16v)	●	●			
16-inch steel wheels with full-diameter flush covers and 205/65 R 16 tyres (2900 2.0CDTI 16v and high roof 2.5CDTI 16v)	●	●		●	
16-inch steel wheels with full-diameter flush covers and 215/65 R 16 tyres (standard roof 2.5CDTI 16v)		●		●	
16-inch five-spoke alloy wheels with 215/65 R 16 tyres		○	●	○	●
Full-size steel spare wheel		●	●	●	●
Tyre inflation kit in lieu of spare wheel	N/C	N/C	N/C	N/C	N/C



## Exterior features

**Standard features** • Tinted glass • Two-speed windscreen wipers with variable intermittent wipe and electric screenwash  
 • Lights-on audible warning • Electric headlight beam levelling • Twin adjustable and foldable door mirrors (wide-angle on driver's side) • High-level tail lights • High-level brake light • Twin reversing lights • Rear fog light • Body side-protection mouldings  
 • Side repeat indicators

<b>Additional features</b>	ecoFLEX Panel van	Panel van	Sportive	Doublecab	Sportive Doublecab
Rear parking distance sensors	○	○	○	○	○
Solar Reflect® windscreen	○	○	○	○	○
Rain-sensitive windscreen wipers	□	□	□	□	□
Automatic Lighting Control (ALC)	□	□	□	□	□
Front fog lights	□	□	●	□	●
Electrically operated front windows	□	□	●	□	●
Electrically adjustable/heated door mirrors	□	□	●	□	●
Body-colour door mirrors			●		●
Body-colour side-protection mouldings			●		●
Part body-colour front bumper			●		●
Body-colour rear bumper, quarter bumpers and rear light cluster surrounds			●		●
Two-coat metallic or pearlescent paint	○	○	● <sup>12</sup>	○	● <sup>12</sup>
Special paint (restrictions apply – please consult your retailer for availability)	○	○		○	

## Option packs

<b>Features</b>	ecoFLEX Panel van	Panel van	Sportive	Doublecab	Sportive Doublecab
<b>Electric Pack</b> • Electrically operated front windows • Electrically adjustable/ heated door mirrors	○	○	●	○	●
<b>Vision Pack</b> • Rain-sensitive windscreen wipers • Automatic Lighting Control (ALC) • Front fog lights • Selective door locking key • Electric Pack	○	○		○	
<b>Vision Pack</b> • Rain-sensitive windscreen wipers • Automatic Lighting Control (ALC) • Selective door locking key			○		○
<b>Smoker Pack</b> • Cigar lighter • Front ashtray	○	○	○	○	○



Rear parking distance sensors (optional).

● = Standard equipment.  
 ○ = Optional at extra cost.  
 N/C = No-cost option.  
 □ = Only available as part of an extra-cost option pack.

9 = Not available with full-height bulkhead (with or without window).  
 10 = Fixed or sliding window options for sliding side-access door(s) also mandates (at extra cost) glazed rear doors.  
 11 = Only available with optional full-height steel bulkhead with window or no-cost option full-height steel load restraint guard behind driver.  
 12 = Star Silver two-coat metallic paint is standard. Glacier White, Midnight Black, Winterwind and Steel Grey are available as no-cost options.



CD player with MP3 format/stereo radio (CD 10 MP3).



Satellite navigation/CD player with MP3 format/stereo radio/Bluetooth (CD 30 BT NAVI).

## Audio, communication and navigation

Features	ecoFLEX Panel van	Panel van	Sportive	Doublecab	Sportive Doublecab
<b>CD player with MP3 format/stereo radio (CD 10 MP3)</b> • CD player with MP3 format • AM/FM stereo radio • Auxiliary-in socket • Integrated display • Two 15-watt speakers • Steering column mounted audio controls	●	●		●	
<b>CD player with MP3 format/stereo radio/Bluetooth® (CD 30 BT)</b> <sup>13</sup> • CD player with MP3 format • AM/FM stereo radio • Auxiliary-in socket • Bluetooth® connectivity for compatible mobile phones • Remote monochromatic display • Two 20-watt speakers • Steering column mounted audio controls		○	●	○	●
<b>CD player with MP3 format/stereo radio/Bluetooth® (CD 30 BT USB)</b> <sup>13</sup> • CD player with MP3 format • AM/FM stereo radio • Auxiliary-in socket • Bluetooth® connectivity for compatible mobile phones • USB connection • Remote monochromatic display • Two 20-watt speakers • Steering column mounted audio controls		○	○	○	○
<b>Satellite navigation/CD player with MP3 format/stereo radio/Bluetooth® (CD 30 BT NAVI)</b> <sup>13</sup> • Satellite navigation system with remote colour monitor • CD player with MP3 format • AM/FM stereo radio • Auxiliary-in socket • Bluetooth® connectivity for compatible mobile phones • Two 20-watt speakers • Steering column mounted audio controls		○	○	○	○
<b>Satellite navigation/CD player with MP3 format/stereo radio/Bluetooth® (CD 30 BT NAVI USB)</b> <sup>13</sup> • Satellite navigation system with remote colour monitor • CD player with MP3 format • AM/FM stereo radio • Auxiliary-in socket • Bluetooth® connectivity for compatible mobile phones • USB connection • Two 20-watt speakers • Steering column mounted audio controls		○	○	○	○
Roof-mounted flexible aerial	●	●	●	●	●

● = Standard equipment. ○ = Optional at extra cost.

<sup>13</sup> = Not available in conjunction with optional digital tachograph.

### Satellite navigation

Clear, attractive graphics show the full range of routing information in either day or night modes, including distance, current speed limit, RDS EON route delay information, and estimated arrival time. There is also a choice between bird's eye view and direct overhead view. Maps cover western European countries. The system is easy to operate and can be updated over the internet.

### Bluetooth® connectivity

Easy to operate, virtually universal in compatibility and included with all optional CD 30 BT and CD 30 BT NAVI audio units – Bluetooth® makes mobile phone communication hands-free and safe.

### USB facility

The optional CD 30 BT and CD 30 BT NAVI units can also be specified with a USB facility and 3.5mm stereo jack plug. This allows iPod™ and memory stick functionality.



## Power and torque curves

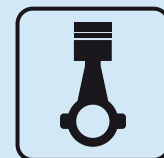
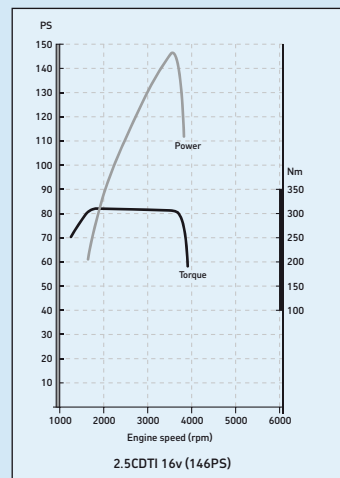
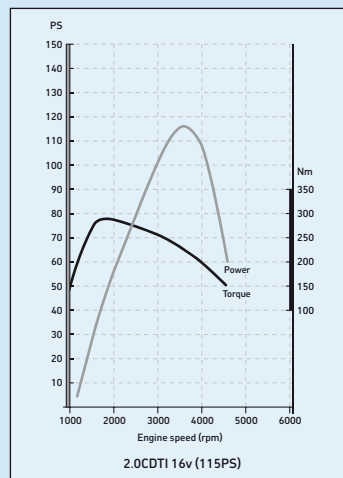
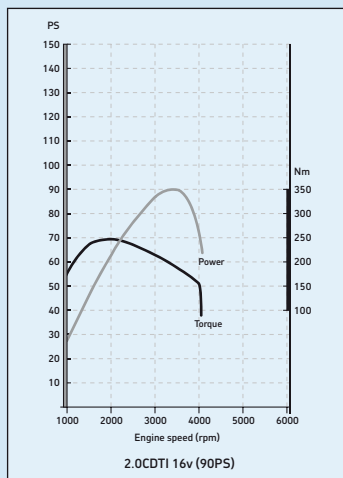

**90PS/  
115PS**  
2.0CDTI 16v  
common rail  
diesel engine

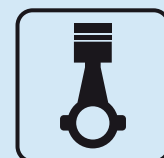

**146PS**  
2.5CDTI 16v  
common rail  
diesel engine

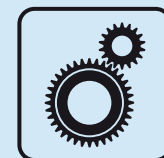

**Tecshift**  
Six-speed  
transmission  
optional on the  
2.0CDTI 16v (115PS)  
(excluding ecoFLEX  
models) and 2.5CDTI  
16v engines

## Engines

	2.0CDTI 16v (90PS)	2.0CDTI 16v (115PS)	2.5CDTI 16v (146PS)
Fuel type	Diesel		
Capacity	1995cc	1995cc	2464cc
Maximum power	90PS (66kW) @ 3500rpm	115PS (84kW) @ 3500rpm	146PS (107kW) @ 3500rpm
Maximum torque	240Nm (177 lb.ft.) @ 1500rpm	290Nm (214 lb.ft.) @ 1600rpm	320Nm (236 lb.ft.) @ 1500rpm
Configuration	4 cylinders, 4 valves per cylinder, double overhead camshafts		
Emission compliance	Euro 4		
Fuel/induction system	Fixed geometry turbocharger and intercooler. Common rail fuel injection.		Variable geometry turbocharger and intercooler. Common rail fuel injection.
Service interval	20.000 miles or one year (whichever occurs sooner)		

## Transmission ratios

	Gear ratios (mph/1000rpm)						Final drive ratio
	1	2	3	4	5	6	
2700 2.0CDTI 16v	4.18:1 (4.4)	2.24:1 (8.3)	1.39:1 (13.3)	0.98:1 (18.9)	0.76:1 (24.3)	0.60:1 (30.8)	4.19:1
2900 2.0CDTI 16v	4.18:1 (4.5)	2.24:1 (8.5)	1.39:1 (13.6)	0.98:1 (19.3)	0.76:1 (24.9)	0.60:1 (31.6)	4.19:1
2700/2900 2.5CDTI 16v	3.91:1 (4.9)	2.11:1 (9.1)	1.39:1 (13.9)	0.98:1 (19.7)	0.76:1 (25.4)	0.60:1 (32.2)	4.19:1



Six-speed manual gearbox.



Six-speed Tecshift transmission (optional).

### Vauxhall Assistance and warranties\*

- All new Vivaros qualify for a three-year vehicle warranty consisting of a one-year/unlimited mileage manufacturer's warranty and a second and third year manufacturer's warranty with a 100,000 miles limitation
- Vauxhall Assistance for 12 months from first registration
- Six years' body panel anti-perforation warranty

\* = Warranty is only available on vehicles sourced from General Motors UK Limited. Terms and conditions apply – please see your Vauxhall retailer for details.

### Transmissions

- Front-wheel drive
- Six-speed manual gearbox
- Six-speed Tecshift transmission – available at extra cost on 2.0CDTI 16v (115PS) (excluding ecoFLEX) and 2.5CDTI 16v models. Tecshift hydraulic transmission offers all the main features and flexibility of a regular automatic, plus the performance and control of a 'one-touch' manual gearbox. Drivers may switch between modes on the move using the gearshift selector

### Steering

- Power-assisted rack and pinion system
- Turning circles (kerb-to-kerb/wall-to-wall):  
SWB – 11.84m (38.8ft)/12.40m (40.7ft)  
LWB – 13.17m (43.2ft)/13.73m (45.1ft)
- Turns lock-to-lock: 3.3

### Suspension

- Front:** Independent wishbones with MacPherson spring struts, control arms and separate galvanised, double isolated, vibration reducing subframe.
- Rear:** Semi-independent with trailing links, progressive-rate mini-block coil springs with rubber bump-stops and telescopic, load-adaptable gas-pressure dampers.

### Brakes

- Anti-lock Braking System (ABS) with Electronic Brakeforce Distribution (EBD)
- Emergency Brake Assist (EBA)
- Vacuum servo-assisted system
- Dual circuit hydraulic system
- Floor-mounted parking brake lever

**Front ventilated disc brakes:**  
305mm diameter.

**Rear disc brakes:** 280mm diameter.

### Electrics

**Maintenance-free battery:** 70Ah.  
**Alternator:** 125A.

### Body

- Six-year body panel anti-perforation warranty
- Galvanised body panels
- Anti stone-chip mastic coating on sills
- Anti-corrosion wax pumped into sills and other underbody cavities
- Flush-fitted windscreen and rear door glass (when specified)
- Detachable front towing eye
- Rear towing eye

### Fuel tank capacity

90 litres (19.8 gallons).

### Insurance groups

Range from 4E – 5E dependent on model specified.



## Glossary of terms

### Plated weight

The maximum weight to which a vehicle or an axle may be loaded, determined either by the design of the components or by legislation. All commercial vehicles must carry a manufacturer's 'plate' showing the vehicle and axle gross 'plated weights'. It is an offence to drive a vehicle in a condition where any of these weights are exceeded.

### Kerbweight

The weight of the complete vehicle in standard form, excluding payload and driver but including coolant, oil, 90% full fuel tank and spare wheel where appropriate. Kerbweights quoted in Vauxhall brochures are subject to manufacturing tolerances and to the fitment of optional equipment and accessories. Where load capacity is critical the actual kerbweight should be obtained by weighing the vehicle on a calibrated public weighbridge.

### Gross Vehicle Weight (GVW)

The total permissible weight of a vehicle including payload and passengers, as shown on the manufacturer's plate.

### Gross Combination Weight (GCW)

The maximum permissible weight of a vehicle, including payload and passengers, combined with the total weight of any trailer it is towing. The maximum GCW weight limit is quoted on the vehicle plate and must not be exceeded.

### Payload

The total permissible weight that can be carried without exceeding the vehicle's plated weight. This can be obtained by deducting the kerbweight from the plated Gross Vehicle Weight (GVW).

**Please note:** the payload figure does not allow for the weight of the driver or any passengers which should therefore be deducted from the figures shown and are also subject to correct weight distribution.

### Maximum towing weight

The maximum weight of any trailer and its load which may be towed within the limit of the vehicle's plated Gross Combination Weight (GCW). It is based on the ability of the vehicle – at full GCW – to restart on a 12% gradient, which is approximately 1 in 8.3, at sea level. At altitudes above 1500 metres, the engine output may drop with a corresponding reduction in towing capability. It is the operator's responsibility to ensure that the trailer noseweight does not cause the rear axle plated weight of the towing vehicle to be exceeded.

*Always fit Vauxhall towing attachments and accessories available from your Vauxhall Commercial Vehicle retailer. They are designed specifically for Vauxhall models and carry a 12-month warranty.*

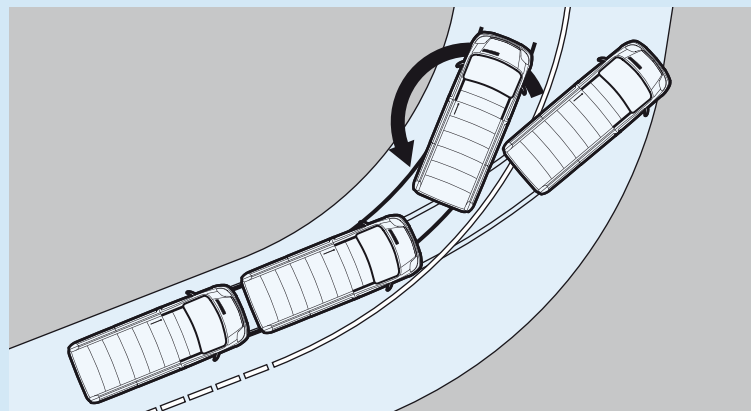

### Electronic Stability Programme-plus (ESP-plus)

Vivaro's optional ESP-plus system goes one step further than the system usually found on Vauxhall's passenger cars. In understeer situations, the system automatically applies corrective braking to the appropriate rear wheel to correct the tendency; in oversteer situations, it automatically applies the brake to the appropriate front wheel. Because a commercial vehicle is also faced with significant weight and load issues which can influence this tendency to understeer or oversteer by affecting the centre of gravity, Vivaro's ESP system also incorporates a load sensor that adjusts the intensity of the braking effort to suit the demands of the payload. The system is available on all Vivaro models not fitted with the Tecshift transmission.

## Panel van

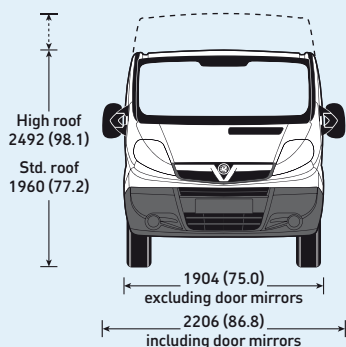

## SWB

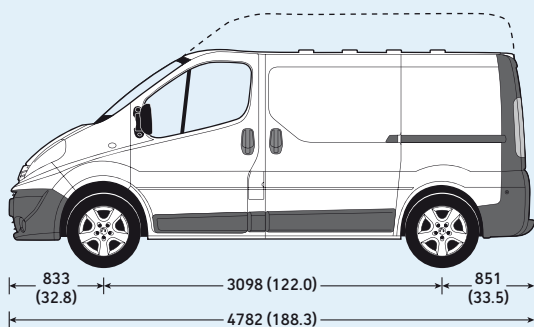

## LWB

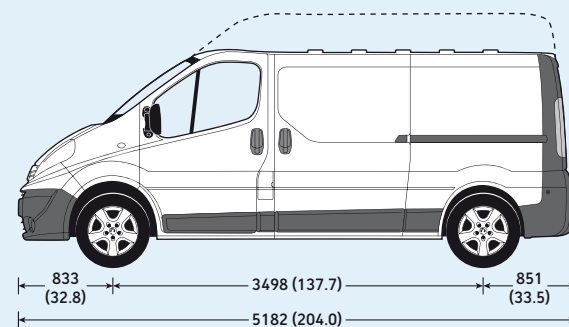

Measurements are shown in millimetres (inches). All heights are shown unladen.

## Panel van

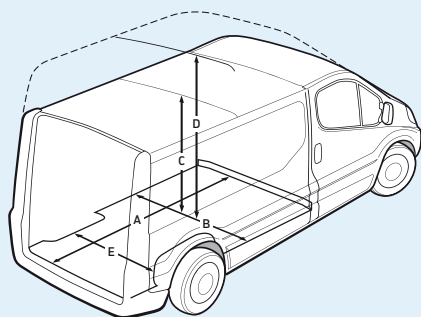

## Loadspace volumes cu.m (cu.ft.)

SAE method	SWB	LWB
Standard roof	5.3 (187)	6.2 (219)
High roof	7.4 (261)	8.7 (307)
VDA method		
Standard roof	5.0 (177)	5.9 (208)
High roof	7.1 (251)	8.4 (297)

## Ground clearance mm (inches)

SWB	Laden	Unladen
2700 std. roof	162 (6.4)	185 (7.3)
2900 std. roof	164 (6.5)	192 (7.5)
2900 high roof	159 (6.3)	193 (7.6)
LWB		
2900 std. roof	158 (6.2)	188 (7.4)
2900 high roof	149 (5.9)	187 (7.4)

## Interior dimensions mm (inches)

Loadspace	SWB	LWB
<b>A</b> Maximum length	2415 (95.1)	2815 (110.8)
<b>B</b> Maximum width	1663 (65.5)	1663 (65.5)
<b>C</b> Maximum height – standard roof	1387 (54.6)	1387 (54.6)
<b>D</b> Maximum height – high roof	1913 (75.3)	1913 (75.3)
<b>E</b> Width between wheel arches	1268 (49.9)	1268 (49.9)
Side door(s)		
Aperture height	1285 (50.6)	1285 (50.6)
Aperture width	1000 (39.4)	1000 (39.4)
Rear doors		
Aperture height – standard roof	1320 (52.0)	1320 (52.0)
Aperture height – high roof	1818 (71.6)	1818 (71.6)
Aperture width (at floor)	1390 (54.7)	1390 (54.7)
Loading height – standard roof	549 (21.6)	542 (21.3)
Loading height – high roof	549 (21.6)	547 (21.5)



## Weights and towing data

SWB panel van models	Transmission	UK plated weights and kerbweights kg						Total Kerb	Payload kg	Plated Gross Combination Weights (GCW) kg
		Front axle		Rear axle		GVW				
		Plated	Kerb	Plated	Kerb					
2700 2.0CDTI (90/115PS) ecoFLEX std. roof	manual	1450	1095	1550	575	2770	1670	1100	4770	
2700 2.0CDTI (90/115PS) std. roof	manual	1450	1095	1550	575	2770	1670	1100	4770	
2700 2.0CDTI (115PS) std. roof	Tecshift	1450	1107	1550	575	2735	1682	1053	4735	
2700 2.5CDTI (146PS) std. roof	manual	1560	1151	1650	577	2820	1728	1092	4820	
2700 2.5CDTI (146PS) std. roof	Tecshift	1580	1163	1650	578	2830	1741	1089	4830	
2700 2.0CDTI (115PS) Sportive std. roof	manual	1450	1121	1550	586	2770	1707	1063	4770	
2700 2.0CDTI (115PS) Sportive std. roof	Tecshift	1450	1133	1550	586	2735	1719	1016	4735	
2700 2.5CDTI (146PS) Sportive std. roof	manual	1560	1177	1650	588	2820	1765	1055	4820	
2700 2.5CDTI (146PS) Sportive std. roof	Tecshift	1560	1189	1650	589	2830	1778	1052	4830	
2900 2.0CDTI (90/115PS) ecoFLEX std. roof	manual	1580	1101	1650	580	2935	1681	1254	4935	
2900 2.0CDTI (90/115PS) std. roof	manual	1580	1101	1650	580	2935	1681	1254	4935	
2900 2.0CDTI (115PS) std. roof	Tecshift	1580	1113	1650	580	2945	1693	1252	4945	
2900 2.5CDTI (146PS) std. roof	manual	1580	1152	1650	577	2985	1729	1256	4985	
2900 2.5CDTI (146PS) std. roof	Tecshift	1580	1164	1650	578	2995	1742	1253	4995	
2900 2.0CDTI (90/115PS) high roof	manual	1580	1098	1650	654	2920	1752	1168	4920	
2900 2.0CDTI (115PS) high roof	Tecshift	1580	1110	1650	655	2935	1765	1170	4935	
2900 2.5CDTI (146PS) high roof	manual	1580	1149	1650	653	2975	1802	1173	4975	
2900 2.5CDTI (146PS) high roof	Tecshift	1580	1161	1650	653	2985	1814	1171	4985	
<b>LWB panel van models</b>										
2900 2.0CDTI (90/115PS) std. roof	manual	1580	1135	1650	582	2960	1717	1243	4960	
2900 2.0CDTI (115PS) std. roof	Tecshift	1580	1147	1650	582	2930	1729	1201	4930	
2900 2.5CDTI (146PS) std. roof	manual	1620	1185	1650	579	3035	1764	1271	5035	
2900 2.5CDTI (146PS) std. roof	Tecshift	1620	1197	1650	580	3005	1777	1228	5005	
2900 2.0CDTI (115PS) Sportive std. roof	manual	1580	1161	1650	593	2960	1754	1206	4960	
2900 2.0CDTI (115PS) Sportive std. roof	Tecshift	1580	1173	1650	593	2930	1766	1164	4930	
2900 2.5CDTI (146PS) Sportive std. roof	manual	1620	1211	1650	590	3035	1801	1234	5035	
2900 2.5CDTI (146PS) Sportive std. roof	Tecshift	1620	1223	1650	590	3005	1813	1192	5005	
2900 2.0CDTI (90/115PS) high roof	manual	1620	1137	1650	665	3010	1802	1208	5010	
2900 2.0CDTI (115PS) high roof	Tecshift	1620	1149	1650	665	3025	1814	1211	5025	
2900 2.5CDTI (146PS) high roof	manual	1620	1188	1650	664	3065	1852	1213	5065	
2900 2.5CDTI (146PS) high roof	Tecshift	1620	1200	1650	664	3070	1864	1206	5070	

**Note:** Kerbweights for standard vehicles include coolant, oil, 90% full fuel tank and spare wheel. They will vary according to the vehicle specification (including options and accessories) with a corresponding variation in payload. Payload figures do not allow for the weight of the driver, or any passengers, which should therefore be deducted from the figures shown and are also subject to correct weight distribution. Gross plated weights (including axle weights) quoted on the vehicle plate must never be exceeded. Roof load maximum 200kg (includes weight of roof carrier) when Vauxhall approved carrier system used. Towing weights should not exceed 750kg (unbraked trailer) or 2000kg (braked trailer).

## Doublecab

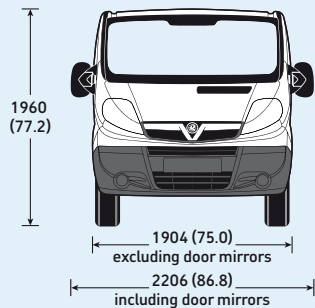

## SWB

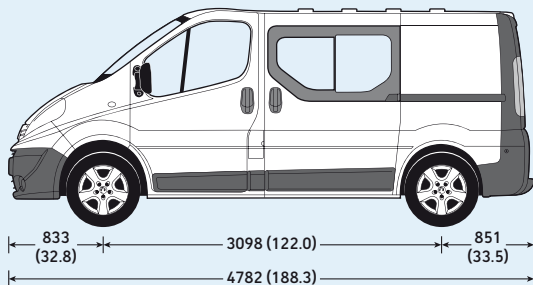

## LWB

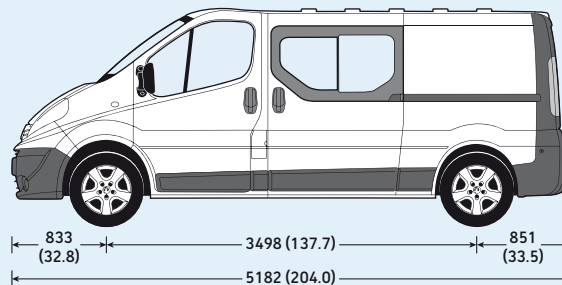

Measurements are shown in millimetres (inches). All heights are shown unladen.

## Doublecab

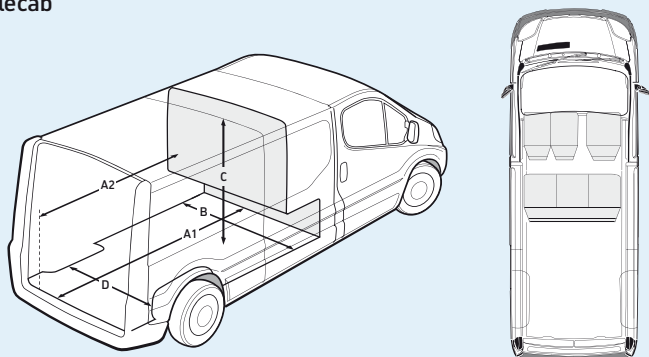

## Interior dimensions mm (inches)

	SWB	LWB
<b>Loadspace</b>		
A1 Maximum length at load floor	1900 (74.8)	2300 (90.5)
A2 Maximum length behind rear seats	1400 (55.1)	1800 (70.9)
B Maximum width	1663 (65.5)	1663 (65.5)
C Maximum height	1387 (54.6)	1387 (54.6)
D Width between wheel arches	1268 (49.9)	1268 (49.9)
<b>Side doors</b>		
Aperture height	1285 (50.6)	1285 (50.6)
Aperture width	1000 (39.4)	1000 (39.4)
<b>Rear doors</b>		
Aperture height – standard roof	1320 (52.0)	1320 (52.0)
Aperture width (at floor)	1390 (54.7)	1390 (54.7)
Loading height – standard roof	549 (21.6)	542 (21.3)

## Loadspace volumes cu.m (cu.ft.)

SAE method	SWB	LWB
Standard roof	3.3 (116)	4.2 (148)

## Weights and towing data

SWB doublecab models	Transmission	UK plated weights and kerbweights kg						Total Kerb	Payload kg	Plated Gross Combination Weights (GCW) kg
		Front axle		Rear axle		GVW				
		Plated	Kerb	Plated	Kerb					
2900 2.0CDTI (90PS/115PS)	manual	1580	1161	1650	643	2935	1804	1131	4935	
2900 2.0CDTI (115PS)	Tecshift	1580	1173	1650	643	2945	1816	1129	4945	
2900 2.5CDTI (146PS)	manual	1580	1212	1650	640	2985	1852	1133	4985	
2900 2.5CDTI (146PS)	Tecshift	1580	1224	1650	641	2995	1865	1130	4995	
2900 2.0CDTI (115PS) Sportive	manual	1580	1187	1650	654	2935	1841	1094	4935	
2900 2.0CDTI (115PS) Sportive	Tecshift	1580	1199	1650	654	2945	1853	1092	4945	
2900 2.5CDTI (146PS) Sportive	manual	1580	1238	1650	651	2985	1889	1096	4985	
2900 2.5CDTI (146PS) Sportive	Tecshift	1580	1250	1650	652	2995	1902	1093	4995	

LWB doublecab models										
LWB doublecab models	Transmission	UK plated weights and kerbweights kg						Total Kerb	Payload kg	Plated Gross Combination Weights (GCW) kg
		Front axle		Rear axle		GVW				
		Plated	Kerb	Plated	Kerb					
2900 2.0CDTI (90PS/115PS)	manual	1580	1195	1650	645	2960	1840	1120	4960	
2900 2.0CDTI (115PS)	Tecshift	1580	1207	1650	645	2930	1852	1078	4930	
2900 2.5CDTI (146PS)	manual	1620	1245	1650	642	3035	1887	1148	5035	
2900 2.5CDTI (146PS)	Tecshift	1620	1257	1650	643	3005	1900	1105	5005	
2900 2.0CDTI (115PS) Sportive	manual	1580	1221	1650	656	2960	1877	1083	4960	
2900 2.0CDTI (115PS) Sportive	Tecshift	1580	1233	1650	656	2930	1889	1041	4930	
2900 2.5CDTI (146PS) Sportive	manual	1620	1271	1650	653	3035	1924	1111	5035	
2900 2.5CDTI (146PS) Sportive	Tecshift	1620	1283	1650	654	3005	1937	1068	5005	

**Note:** Kerbweights for standard vehicles include coolant, oil, 90% full fuel tank and spare wheel. They will vary according to the vehicle specification (including options and accessories) with a corresponding variation in payload. Payload figures do not allow for the weight of the driver, or any passengers, which should therefore be deducted from the figures shown and are also subject to correct weight distribution. Gross plated weights (including axle weights) quoted on the vehicle plate must never be exceeded. Roof load maximum 200kg (includes weight of roof carrier) when Vauxhall approved carrier system used. Towing weights should not exceed 750kg (unbraked trailer) or 2000kg (braked trailer).

## Fuel economy and emissions

All panel van/doublecab models	Fuel economy mpg (litres/100km)			CO <sub>2</sub> (g/km)
	Urban driving	Extra-urban driving	Combined figure	
2.0CDTI (90/115PS) ecoFLEX (panel van only)	31.7 (8.9)	47.9 (5.9)	40.3 (7.0)	185
2.0CDTI (90/115PS)	33.2 (8.5)	42.8 (6.6)	38.7 (7.3)	195
2.0CDTI (115PS) Tecshift	35.8 (7.9)	41.5 (6.8)	39.2 (7.2)	192
2.5CDTI	27.2 (10.4)	37.2 (7.6)	32.5 (8.7)	229
2.5CDTI Tecshift	31.0 (9.1)	35.8 (7.9)	34.0 (8.3)	220

Fuel consumption and CO<sub>2</sub> emission data complies with the relevant EU regulations. **Important:** the results given relate to the particular vehicle tested; inevitably there are differences between individual vehicles of the same model. Driving style, road and traffic conditions, vehicle mileage and standard of maintenance may also affect fuel consumption.



# Trust Vauxhall

## Protecting the environment

Vauxhall's commitment to the environment is demonstrated by our products' many environmental awards, won both through the use of more recycled materials and by becoming cleaner and more efficient. For information on Vauxhall's efforts to achieve an environmentally sustainable future, see [www.vauxhall.co.uk/recycling](http://www.vauxhall.co.uk/recycling)

## Fleet Customer Services

Our dedicated support services for fleet managers includes factory demonstrators and information on whole life costs, company car and van taxation and finance. For further information please call **0870 010 0651**.

## Vauxhall Extended Warranty

For complete peace of mind Vauxhall offers an extended warranty that can be purchased on an annual basis following the expiry of the original new vehicle warranty. It covers most mechanical and electrical components. Terms and conditions apply, for further details please contact your local Vauxhall Commercial Vehicle retailer.



When you have finished with this brochure please recycle it

## Business Lease

Business Lease, from GMAC, offers the versatility of a purchase-based finance plan, while making the most efficient use of tax and cash-flow benefits for VAT-registered business users. It's available for all Vauxhall Commercial Vehicles up to 12 months old and offers highly flexible term lengths, variable deposits and a choice of payment profiles. Ask your retailer for full details.

## Business First

Available to business users only, Business First enables you to drive a new vehicle without a large, initial financial outlay. You pay to use the vehicle, not to own it. The vehicle is provided over a predetermined period, and when that period comes to an end the vehicle is returned. Ask your retailer for full details.

## Servicing and maintenance

The best way to maximise the performance and reliability of your Vauxhall is to have all routine servicing and maintenance carried out at a Vauxhall Commercial Vehicle retailer. Nationwide there are over 250 light commercial vehicle retailers and a further 195 heavy commercial vehicle retailers.

## In the event of an accident...

Vauxhall Accident Support helps keep you mobile following an accident. Benefits include scene-of-accident advice, message service, assistance with claims and vehicle recovery. For further details call **0800 010 304**.

## Premier Service Centres

Our Premier Service Centres feature a guaranteed same day repair service (provided the parts are in stock) and an appointment-free service for diagnosis and repairs taking less than 90 minutes. All repairs are carried out within 24 hours of the diagnosis.

## For more information...

For a brochure on any Vauxhall model (up to a maximum of three per caller) or location of your nearest retailer, call **0845 600 1500**.

Alternatively, details can be found on our website at: [www.vauxhall.co.uk/vans](http://www.vauxhall.co.uk/vans)

Proud Sponsor of Home Nations Football



**Vivaro brochures**  
(VM1009147, VM1009019, VM1009020)

**Please note:** Until further notice, all optional CD 30 audio units will be unavailable for order and replaced by CD 20 units. Sportive models will feature CD 20 as standard. Please consult your Vauxhall Commercial Vehicle retailer for more information.

04/11

VM1109412

Every effort has been made to ensure that the contents of this publication were accurate and up-to-date at the time of going to press (April 2011). Vauxhall vehicles are equipped with components manufactured by various General Motors operating units and outside suppliers. The Company reserves the right to alter specifications and withdraw products from sale without notice. Any such alterations will be notified to Vauxhall retailers at the earliest opportunity, please consult your local retailer for the latest information. The specifications detailed within this brochure are not necessarily applicable to alternative models such as Special Editions. Details of any such models will be contained in specific literature or found on the Vauxhall website. Please note that Vauxhall retailers are not the agents of General Motors UK Limited and are not authorised to bind the Company by any specific or implied undertaking or representation. It is advisable to ensure that your motor insurance policy provides adequate cover for additional fitted options and accessories. Please note accessories shown are for illustrative purposes only. As part of Vauxhall's policy of environmental care, this brochure is printed on paper manufactured using Elemental Chlorine Free pulps from specially farmed, sustainable timber resources. All rights reserved. No part of this publication may be reproduced in any form or by any means, without the prior written permission of General Motors UK Limited.

VM1009147 ©2011 General Motors UK Limited Published April 2011 General Motors UK Limited, Luton LU1 3YT

**COMMERCIAL VEHICLES**  
*The Wheels of Business*



**VAUXHALL**