

VXR

2013 Models Edition 1



Proud Sponsor of Home Nations Football





SHORTENS STRAIGHTS STRAIGHTENS CORNERS

This is extra-sensory stimulation. Cars with soul and power to make you feel alive, electrified and inspired. A range of driver-focused, performance machines that just demand to be driven.

This brochure covers Corsa VXR, Corsa VXR Nürburgring Edition, Astra VXR, Insignia VXR and VXR8 models only. Some of the models shown include options and accessories available at extra cost. And not all of the features described are available on every model. So for all current model or equipment details visit the Vauxhall website: www.vauxhall.co.uk. The colours reproduced throughout this brochure may vary slightly from the actual paint colour. As a result, they should be used as a guide only. Your Vauxhall Retailer has a comprehensive display of our paint samples.

CONTENTS

VXR RANGE

Live the Change	4
Corsa VXR	6
Corsa VXR Nürburgring Edition	12
Astra VXR	14
Insignia VXR	20
Corsa, Astra, Insignia Technical Guide	28
Corsa, Astra, Insignia Options	34
VXR8	36
VXR8 Clubsport and Maloo	42
VXR8 Enhanced Driver Interface	44
VXR8 Chassis Dynamics	45
VXR Colours and Trims	48

VXR LIVE THE CHANGE

Advances in automotive technology have diluted the modern driving experience to the point where many of today's 'performance' cars have become soulless and uncommunicative. You feel like you're not actually driving. You feel like you're being driven: you feel disconnected.

VXR changes all that. VXR is here to reconnect the driver to the road – not with a wire, but with a heartbeat. There's a range of VXR models, every one a focused performance machine, the kind you want to be driving if you like to get up in the night for a blast, just for the hell of it. If you are that type of person, then you've got VXR in your blood. You just might not know it yet.





CORSA VXR

The power to reach 60mph in just 6.5* seconds. The ability to stay in control from a dynamic sports chassis set-up. The reassurance that comes from a range of serious safety features. Choose your weapon – VXR or VXR Nürburgring Edition model. All you need do is point and shoot.

18-inch alloy wheels and Adaptive Forward Lighting are optional at extra cost. *Nürburgring Edition models.





➤ SERIOUSLY INVOLVING

You don't just get into the Corsa VXR. You tune in. Every aspect, detail and material exists for one reason alone. To connect you to the road.

Interior features

- Recaro shell-backed sports front seats with Morrocana-trimmed side bolsters and integral head restraints
- Driver's and front passenger's front, side-impact and curtain airbags
- Three-spoke flat-bottomed leather-covered sports steering wheel with VXR logo
- Unique VXR instrument panel with stepper motor speedometer and tachometer
- Unique VXR gear knob
- Sports pedals
- VXR alloy-effect door sill covers
- CD/MP3 CD player/aux-in/stereo radio (CD 30 MP3)
- Remote control security alarm system
- Air conditioning
- Cruise control
- Trip computer





2

1. Recaro seats. Corsa VXR comes with height-adjustable, 'shell-backed' Recaro VXR sports front seats to keep you in place when the going gets a little quick. They provide just the support you need right where you need it. And they look pretty awesome too.

2. VXR fascia. Think of it as VXR mission control. This is where it all happens if you're a Corsa VXR driver. Black sports instruments with translucent rings and red highlights. Piano black-effect centre console with quality CD 30 MP3 audio and aux-in socket. Illuminated translucent switches. Cruise control. Trip computer. And you.

3. VXR steering wheel. You don't stick any old wheel on a car like Corsa VXR. This three-spoke is trimmed in black leather with silver stitching and the audio remote controls in cool Piano black-effect panels. It's flat-bottomed too and has a VXR logo mounted in its own alloy trim.

4. VXR detailing. The Corsa VXR interior is packed with VXR-specific details. A leather-trimmed gear knob with VXR logo takes charge of the six-speed gearbox. There are sports pedals, and VXR-logo floor mats and sill covers.

3

4

DESIGNED TO SET THE HEART RACING

The name says it all. The Corsa VXR means business. Just one glance at the honeycomb sports front grille, the rear roof spoiler and the side sills and you know this car promises performance. And under the bonnet it more than delivers. Corsa VXR is capable of 0-60mph in a mere 6.8 seconds thanks to a turbocharged 1.6i 16v engine.

Exterior features

- VXR rear roof spoiler **1.**
- VXR honeycomb sports front grille and air dam/bumper
- VXR front fog lights with alloy-effect surround
- Unique VXR twin-arm door mirrors **2.**
- VXR side sills
- VXR rear bumper incorporating diffuser
- VXR triangular centre exit exhaust tailpipe **3.**
- Dark-tinted rear windows optional at extra cost

Design theme. Corsa VXR's electrically heated door mirrors, front fog light surrounds and centre exit exhaust tailpipe all share a unique triangular design theme.

Alloy wheels. The 17-inch Y-design alloy wheel **4.** is standard on Corsa VXR with 215/45 R 17 ultra-low profile tyres. And if you fancy something a little wilder, how about the optional 18-inch alloy wheels with 225/35 R 18 ultra-low profile tyres **5.** Serious performance and visual impact all in one package.



Engine, transmission and chassis. Whichever way you look at it, Corsa VXR doesn't hang around. The lightweight 1.6 litre turbo puts out 192PS and the software controlled overboost increases maximum torque to 260+Nm for safer overtaking. No worries in the chassis department either. With lowered sports suspension, bigger brakes, switchable Electronic Stability Programme (ESP) with traction control and ABS with straight line stability control and cornering brake control – it's all designed for rapid, safe progress.

Engine

- 1.6i 16v ECOTEC-4 Turbo (1598cc)
- Maximum power: 192PS (141kW) @ 5850rpm
- Maximum torque: 230Nm* (170 lb.ft.) @ 1980-5850rpm
- Compression ratio: 8.8:1
- Bore/stroke: 79.0mm x 81.5mm
- Turbocharger integrated into exhaust manifold
- Intercooler
- Sodium-filled exhaust valves

*Increased to 260+Nm for five seconds with turbo overboost function.

Performance

- (manufacturer's figures)
- Maximum speed: 140mph
- Acceleration 0-60mph: 6.8secs

Fuel economy and emissions

- mpg** (litres/100km)
- Urban driving: 28.8 (9.8)
- Extra-urban driving: 47.9 (5.9)
- Combined figure: 38.7 (7.3)
- CO₂ emissions: 172g/km

Chassis, suspension and brakes

- Lowered and uprated VXR sports suspension **i** see page 29
- Switchable Electronic Stability Programme (ESP) including traction control
- Front ventilated disc brakes: 308mm diameter
- Rear disc brakes: 264mm diameter

Transmission

- Six-speed manual gearbox
- Gear ratios:
1st – 3.82:1, 2nd – 2.16:1,
3rd – 1.48:1, 4th – 1.07:1, 5th – 0.88:1,
6th – 0.74:1, Final drive – 4.18:1

Wheels and tyres

- 17-inch Y-design alloy wheels with 215/45 R 17 ultra-low profile tyres
- 18-inch 5 Y-spoke forged bi-colour alloy wheels with 225/35 R 18 ultra-low profile tyres, optional at extra cost
- Car supplied with emergency tyre inflation kit in lieu of spare wheel

Insurance group (ABI recommended)

- 50 Group rating – 32D



5 18-inch 5 Y-spoke forged bi-colour alloy wheels with 225/35 R 18 ultra-low profile tyres, optional at extra cost

Tyre rating (according to EU Regulation 1222/2009)		
Tyre size	215/45 R 17	225/35 R 18
Fuel efficiency group	E	E
Wet grip performance	B	B
External noise measured (dB)	75	77
External noise group	(C))	(C))

> CORSA VXR NÜRBURGRING EDITION

When you name a car after one of the toughest race tracks in the world, it had better deliver. The Corsa VXR Nürburgring Edition delivers. Big time.



Blooded at Germany's notorious Nürburgring Nordschleife – the test circuit to end all test circuits – a 205PS 1.6 litre turbocharged engine, Drexler mechanical limited-slip differential, Bilstein developed chassis set up, uprated sports exhaust and high performance Brembo braking say this is Vauxhall's most powerful Corsa ever. The result? A seriously engaging track-taming sensation that does full justice to the VXR badge.

Nürburgring Interior. Shell-backed' Recaro sports front seats **1**. VXR facia, steering wheel, gear knob and sports pedals. And driver-focused ergonomics that put you fully in control. The Touch and Connect multi-media satellite navigation system is optional at extra cost **2**. Unique 'Nürburgring Edition' black-finish door sill covers set the tone **3**. Striking VXR-style details underline the message.



For more detailed information
please ask your Vauxhall retailer
for a copy of the separate Corsa
VXR Nürburgring brochure or
log on to www.vxr.co.uk

Nürburgring Exterior. The Nürburgring signals its sporting intent with a hardcore stainless steel dual exhaust system. Newly designed 18-inch lightweight forged alloy wheels in high-gloss Anthracite. And serious rubberware: 225/35 R 18 ultra-low profile tyres for massive grip **4**. With 250-280Nm* of torque and 205PS, the Nürburgring Edition piles on the performance as cleanly as you like. To harness the power potential, the Nürburgring employs a Drexler traction-enhancing mechanical multi-plate limited-slip differential. Brembo four-piston front brakes ensure exceptional stopping ability too **5**.

*Increased to 280Nm with turbo overboost function.



Fuel economy and emissions

mpg (litres/100km)

- Urban driving: 27.7 (10.2)
- Extra-urban driving: 46.3 (6.1)
- Combined figure: 37.2 (7.6)
- CO₂ emissions: 178g/km

The Nürburgring Edition is available in four colours – all red hot. Choose from Glacier White, Chilli Orange, Lime Green or Black Sapphire. Check them out on page 48.

ASTRA VXR

When you're left breathless, sweating and with the sound of your own heartbeat pounding in your ears, don't say we didn't warn you. The new Astra VXR is here. And it means business. Packing an aggressive 280PS, 400Nm 2.0 litre turbocharged direct injection engine, it's just begging to be taken out for a blast. With a custom-built chassis – developed at the renowned Nürburgring – featuring HiPerStrut front suspension with limited-slip differential and a Watts link semi-independent rear suspension there's unparalleled connection with the road. Add drop-dead exterior styling including meaty 19-inch alloys and this extraordinary VXR won't just turn heads – it'll blow minds.





➤ WHERE MAN MEETS MACHINE

Take a seat in the new Astra VXR and kick your senses into overdrive. From the very moment you get behind the wheel, you'll recognise this interior has been designed with real drivers in mind.

Interior features

- Premium VXR sports front seats with Morrocana side bolsters
- Three-spoke flat-bottomed leather-covered sports steering wheel with VXR logo
- Unique VXR instrument graphics
- VXR floor mats
- VXR leather-covered gear knob
- VXR sports pedals
- VXR alloy-effect door sill covers

1. VXR Instruments. Bold instrument graphics and sports pedals set your heart racing before you've even turned the key. We've even included a flat-bottomed leather-covered steering wheel with VXR detail to give you something to cling to when the fun really starts.

2. 3. VXR Infotainment. A mobile phone system with Bluetooth® as standard and optional sat nav mean you can stay in touch wherever your journey takes you. A DMB digital radio and USB connection are there too to add that favourite soundtrack to your drive.





VXR detailing. The unique VXR detailing, premium VXR sports front seats and intuitive driver ergonomics leave no doubt as to why this VXR just demands to be driven.

VXR Performance Seat Pack.

For the ultimate driving experience specify this optional Pack featuring electrical adjustment with powered lumbar and side bolster supports. This is also included when you choose the Leather Pack option (illustrated left and below). Available with black or blue central stripe.



3 LETTERS, 1 MESSAGE: VXR PERFORMANCE

Make no mistake about it – the new Astra VXR was born to perform. Every inch of this adrenalin-pumping sporting masterpiece has been geared towards rubber hitting road. Don't believe us? Take a look for yourself:

Exterior features

- VXR honeycomb sports front grille and air dam/bumper
- VXR side sills
- VXR rear bumper with diffuser **2.**
- VXR rear roof spoiler
- Performance-optimised twin-exit exhaust system tuned for sound
- LED tail lights
- 19-inch five-spoke alloy wheels

VXR Aero Pack*. Take VXR visual impact to the max.

- VXR bi-plane rear roof spoiler **1.**
- VXR extended side sills **4.**
- 20-inch five-Y-spoke forged bi-colour alloy wheels **4.**

3. VXR button. Hit the VXR button and the Astra VXR tightens the suspension, sharpens the throttle response and makes the steering more direct.

VXR Performance Seat Pack*.

The ultimate in comfort and support.

- Electrically adjustable sports front seats with manually adjustable seat cushions
- Electric lumbar and bolster adjustment
- Electrically heated front seats



*Optional at extra cost.

Engine, transmission and chassis. The new Astra VXR is not only one of the most powerful cars in its class, it's the fastest production Astra in Vauxhall's history. At its heart is a 2.0 litre turbocharged direct injection engine, producing 280PS of power and an impressive 400Nm of torque – capable of launching it to 60 miles per hour in 5.9 seconds.

Engine

- 2.0i 16v ECOTEC-4 Turbo (1998cc)
- Maximum power:
280PS (206kW) @ 5300rpm
- Maximum torque:
400Nm (295 lb.ft.) @ 2400-4800rpm
- Compression ratio: 9.3:1
- Bore/stroke: 86.0mm x 86.0mm
- Turbocharger integrated into exhaust manifold
- Intercooler
- Sodium-filled exhaust valves

Performance

- (manufacturer's figures)
- Maximum speed: 155mph
- Acceleration 0-60mph: 5.9secs

Fuel economy and emissions mpg (litres/100km)

- Urban driving: 26.2 (10.8)
- Extra-urban driving: 43.5 (6.5)
- Combined figure: 34.9 (8.1)
- CO₂ emissions: 189g/km

Chassis, suspension and brakes

- HiPerStrut front suspension system
i see page 29
- Lowered and uprated VXR sports suspension i see page 29
- Switchable Electronic Stability Programme (ESP) including traction control
- Brembo ventilated/cross drilled, front disc brakes: 355mm diameter
i see page 32
- Brembo 4-piston front brake calipers
i see page 32
- Ventilated rear disc brakes: 315mm diameter
- Drexler Limited Slip Differential (LSD)
i see page 31

Transmission

- Six-speed manual gearbox

Wheels and tyres

- 19-inch five-spoke alloy wheels with 245/40 R 19 ultra-low profile tyres
- 20-inch five-Y-spoke forged bi-colour alloy wheels with 245/35 R 20 ultra-low profile tyres (optional at extra cost as part of the VXR Aero Pack)
- Car supplied with emergency tyre inflation kit in lieu of spare wheel

Insurance group (ABI recommended)

- 50 Group rating – 35E



Standard 19-inch five-spoke alloy wheels with 245/40 R 19 ultra-low profile tyres.



Optional at extra cost as part of the VXR Aero Pack, 20-inch five-Y-spoke forged bi-colour alloy wheels with 245/35 R 20 ultra-low profile tyres.

Tyre rating (according to EU Regulation 1222/2009)

Tyre size	245/40 R 19	245/35 R 20
Fuel efficiency group	E	E
Wet grip performance	B	B
External noise measured (dB)	72	72
External noise group	(C-1)	(C-1)

INSIGNIA VXR

If Insignia speaks a whole new language. Insignia VXR talks in absolutes. A 2.8 litre V6 Turbo that develops 325PS. A massive 435Nm of torque. And 0-60mph acceleration in just 5.6 seconds*. But it's not just about absolute power. But absolute control. An adaptive 4X4 system, electronic Limited Slip Differential (eLSD) and HiPerStrut front suspension system put the driver in total command. And you can specify an automatic model with paddle-shift controls on the steering wheel. Because we understand that with power, comes responsibility.

*Manual hatchback and saloon models.





INSIGNIA VXR

When it comes to identity, Insignia VXR has clearly got something to say.

Muscular front bumper with vertical air intakes, rear diffuser and integrated matt chrome tailpipes on every model – hatchback, saloon and Sports Tourer.

But this VXR says everything about performance styling in the appropriate tone.

When you're this confident in your ability, there's no need to raise your voice.



20-inch alloy wheels and two-coat metallic paint optional at extra cost.



➤ DYNAMIC PERFORMANCE NEEDS DYNAMIC STYLE

Ease yourself into the driver's seat of the Insignia VXR and the sense of confidence is awe-inspiring. Dripping with both technology and comfort, this is a car designed specifically to bond driver with machine.

1. Sporting comfort. Slip into the Recaro sports front seats. Get yourself comfortable with the driver's seat height and lumbar adjustment and Morrocana-trimmed side bolsters. Now you're ready for when the fun starts.

2. DMB digital radio. The DMB digital radio means digital quality sound, a broader range of stations, easier to find by name and improved track display info on some stations.

3. VXR instruments. Insignia VXR takes care of driver information via a well-appointed cluster of red accented instruments, with digital graphic display of oil temperature, oil pressure and boost pressure figures.

4. Sporting details. The VXR heritage is further emphasised by the unique VXR gear knob, VXR-logo floor mats and alloy-effect door sill covers.

5. Automatic transmission with paddle-shift. Insignia VXR is now available with a six-speed automatic transmission complete with steering wheel mounted paddle-shift for fingertip sequential gear changes.



Interior features

- Recaro sports front seats with Morrocana-trimmed side bolsters
- Driver's and front passenger's front, side-impact and curtain airbags
- Three-spoke flat-bottomed leather-covered sports steering wheel with VXR logo
- Unique VXR instrument panel graphics
- VXR gear knob
- VXR floor mats
- VXR leather-covered gear knob
- VXR sports pedals
- VXR alloy-effect door sill covers
- CD/MP3 CD player/aux-in/stereo radio with DMB (CD 400) and graphic display
- Ambient interior lighting
- Automatic Lighting Control (ALC)
- Electro-chromatic anti-dazzle rear-view mirror
- Single-zone Electronic Climate Control (ECC)
- Cruise control
- Trip computer
- Remote control security alarm system



Navi 600 satellite navigation system and Leather Pack are optional at extra cost.

➤ PRESENCE AND PERFORMANCE

The VXR styling features are a clue to a truly unique machine. Beneath this exterior is an exceptional performance engine. A 2.8i, 24-valve, V6 turbocharged engine that propels this four-wheel drive car at an astonishing rate. Pure performance meets pure style.

Exterior features

- VXR front grille and air dam/bumper **1.**
- VXR side sills
- VXR rear bumper and rear skirt
- VXR rear lip spoiler (hatchback/saloon)
- VXR rear roof spoiler (Sports Tourer)
- Performance-optimised exhaust system tuned for sound **5.**
- Intelligent Adaptive Forward Lighting (AFL) incorporating bi-xenon headlights
- Rain-sensitive windscreen wipers
- Tyre pressure monitoring system

2. Adaptive Forward Lighting (AFL).

Insignia VXR's Intelligent AFL headlights change their pattern to suit the location and the weather. Sensing where you

need the light most, they can even help you see around corners. And if something is coming the other way, they dip automatically.

3. Alloy wheels. Serious wheel and tyre combinations are a VXR speciality. Insignia VXR comes with 19-inch V-spoke alloys and high-grip 245/40 R 19 ultra-low profile tyres as standard. Want to go bigger? Try the 20-inch forged alloy option with 255/35 R 20 ultra-low profile tyres.

4. VXR button. Hit the VXR button and the Insignia VXR tightens the suspension, sharpens the throttle response and makes the steering more direct.



Engine, transmission and chassis. Make no mistake. Insignia VXR is designed to perform. The all-aluminium, 24-valve V6 turbo features dual variable valve timing (VVT). Each piston is individually oil-cooled. The exhaust valves are sodium-filled and the throttle is electronically controlled. The single, twin-scroll turbocharger feeds the mixture via twin individual variable inlet manifolds. And the end result? Seamless, explosive power delivery. Through a computer-controlled, Nürburgring-proven, 4X4 chassis that puts you in total control. Absolutely.

Engine

2.8i 24v ECOTEC-V6 Turbo (2792cc)

Maximum power:

325PS (239kW) @ 5250rpm

Maximum torque:

435Nm (321 lb.ft.) @ 5250rpm

Compression ratio: 9.5:1

Bore/stroke: 89.0mm x 74.8mm

- Single, twin-scroll turbocharger with intercooler

- Variable valve timing

Performance (manufacturer's figures)

Maximum speed (mph):

	Man	Auto
Hatch/Saloon	155	155
Sports Tourer	155	155

Acceleration 0-60mph (secs):

Hatch/Saloon	5.6	5.9
Sports Tourer	5.9	6.2

Fuel economy and emissions

mpg (litres/100km)

	Man	Auto
Urban driving:		
Hatch/Saloon	17.9 (15.8)	17.5 (16.1)
Sports Tourer	17.7 (16.0)	16.9 (16.7)

Extra-urban driving:

Hatch/Saloon	37.2 (7.6)	37.7 (7.5)
Sports Tourer	35.8 (7.9)	36.2 (7.8)





Combined figure:

Hatch/Saloon	26.6 (10.6)	26.4 (10.7)
Sports Tourer	25.9 (10.9)	25.7 (11.0)

CO₂ emissions: g/km

Hatch/Saloon	249	251
Sports Tourer	255	259

Chassis, suspension and brakes

- HiPerStrut front suspension system  see page 29
- Adaptive 4X4 permanent four-wheel drive system with FlexRid^e  see page 30
- Brembo ventilated/cross drilled, front disc brakes: 355mm diameter  see page 32
- Brembo 4-piston front brake calipers  see page 32
- Ventilated rear disc brakes: 315mm diameter
- Electronic Limited Slip Differential (eLSD)  see page 31

Transmission

- Six-speed manual gearbox
- Six-speed automatic with paddle-shift facility optional at extra cost



Wheels and tyres

- 19-inch V-spoke alloy wheels with 245/40 R 19 ultra-low profile tyres
- 20-inch five Y-spoke forged bi-colour alloy wheels with 255/35 R 20 ultra-low profile tyres, optional at extra cost (illustrated on page 19)
- Car supplied with emergency tyre inflation kit in lieu of spare wheel

Insurance group (ABI recommended)

- 50 Group rating – 36E

Tyre rating (according to EU Regulation 1222/2009)

Tyre size	245/40 R 19	255/35 R 20
Fuel efficiency group	E	E
Wet grip performance	B	B
External noise measured (dB)	72	73
External noise group		

➤ TECHNOLOGY EXPLAINED

You don't have to be a race car designer to understand why VXR models are so special. The results speak for themselves. But just in case you're wondering about what lies behind our performance features, we've explained a few of them here in a little more detail.

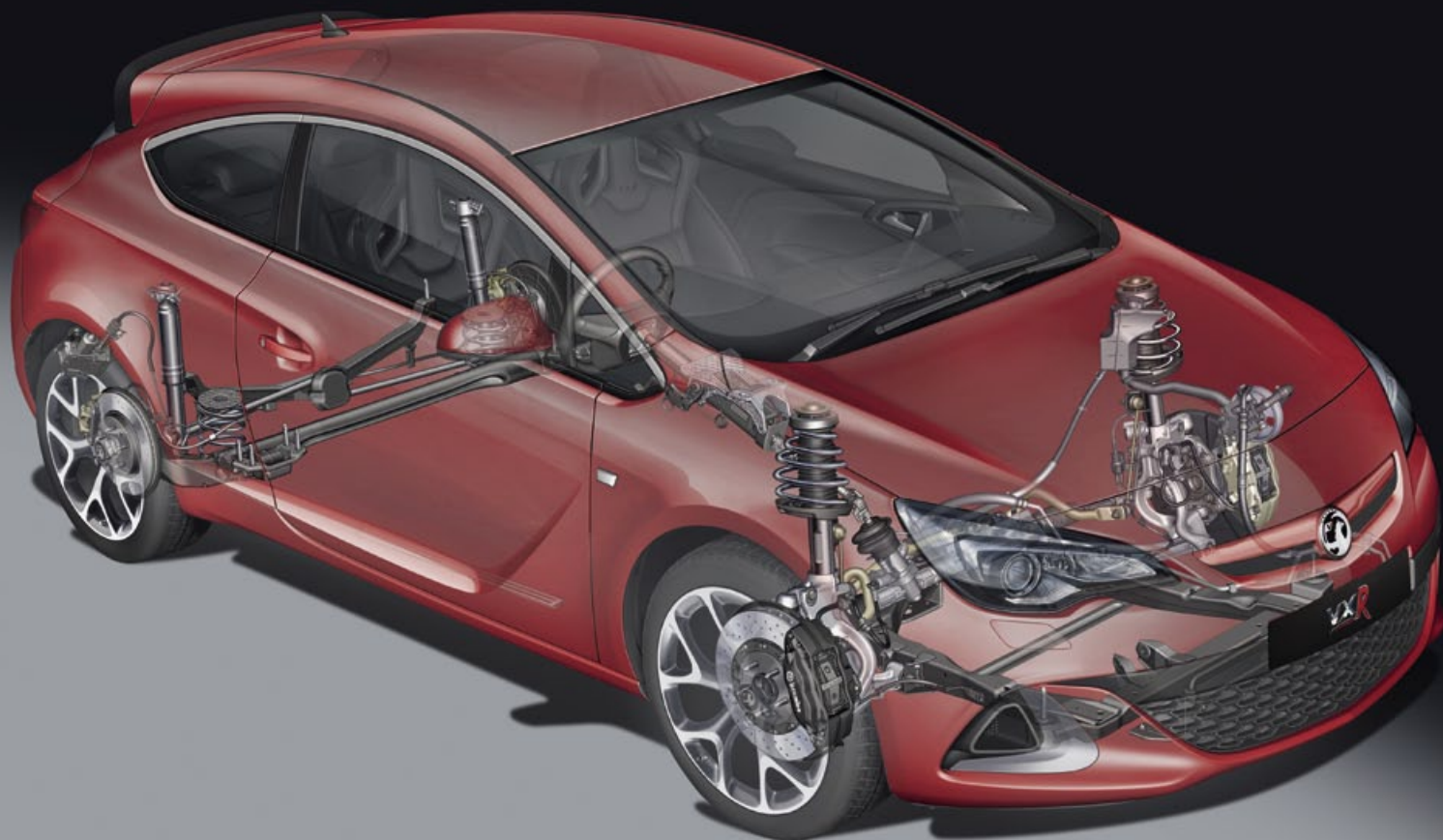

1

1. Sports suspension. It could be argued that creating a sports suspension system is relatively easy; simply fit some uprated springs, dampers and, possibly, anti-roll bars and it's ready. There are plenty of aftermarket kits available, after all. But for VXR we wanted to go a few steps beyond.

VXR models feature all of these, naturally, but we've incorporated a number of extra suspension and steering revisions that separate them from other sports models in the Vauxhall range. Features such as stronger, low-friction anti-roll bar mounts and drop links, which allow the anti-roll bars to work at peak efficiency at all times. Rebound stop springs within the dampers, designed to reduce traction-robbing pitch from the chassis, and revised steering geometry, which gives drivers increased feedback and allows them to more accurately judge grip levels. In fact, the Corsa VXR Nürburgring Edition model features specially commissioned progressive-rate springs and inverted monotube dampers courtesy of Bilstein. In addition to the considerable chassis work on the UK's unique road surfaces, much of the development of the VXR range was carried out at the legendary Nürburgring Nordschleife circuit in Germany, the ultimate test of chassis performance. Manuel Reuter, twice winner of the Le Mans 24-hour race, was on the test team and his vast experience contributed to the final set-up of the cars.

2. HiPerStrut front suspension. The Astra and Insignia VXR use a significant evolution of the regular models' MacPherson strut front suspension. The HiPerStrut (High Performance Strut) front suspension improves grip and allows more power to be applied during cornering. The realigned kingpin axis keeps the front tyres squarer to the road during cornering, providing a better contact patch with the tyre thus delaying the onset of understeer. Additionally the shorter spindle length on the hub significantly reduces torque steer and resists steering kickback on bends and on uneven surfaces. In addition, compared to the standard Astra GTC and Insignia SRi models, the ride height of the Astra and Insignia VXR has been reduced by 10mm, spring rates have been stiffened and bespoke suspension bushes are used. To achieve the best handling balance, the front and rear anti-roll bar diameters have also been revised. All of this bespoke VXR engineering detail allows the driver to better exploit the power potential of both these powerful VXR models.

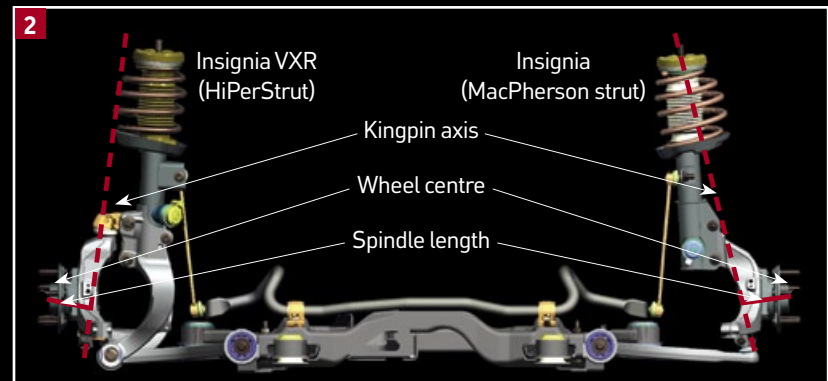

► TECHNOLOGY EXPLAINED

1. Insignia Adaptive 4X4. The advantages begin when you pull away. All four wheels of the Insignia are engaged for stable acceleration with maximum grip. In normal driving, the power is split 95% front/5% rear, but under acceleration the system automatically diverts more power to the rear wheels for maximum traction before gradually moving power back towards the front wheels. With either the VXR or Sport button depressed, the system apportions more power to the rear wheels in a 40% front/60% rear split to give an even more sporting feel.

1

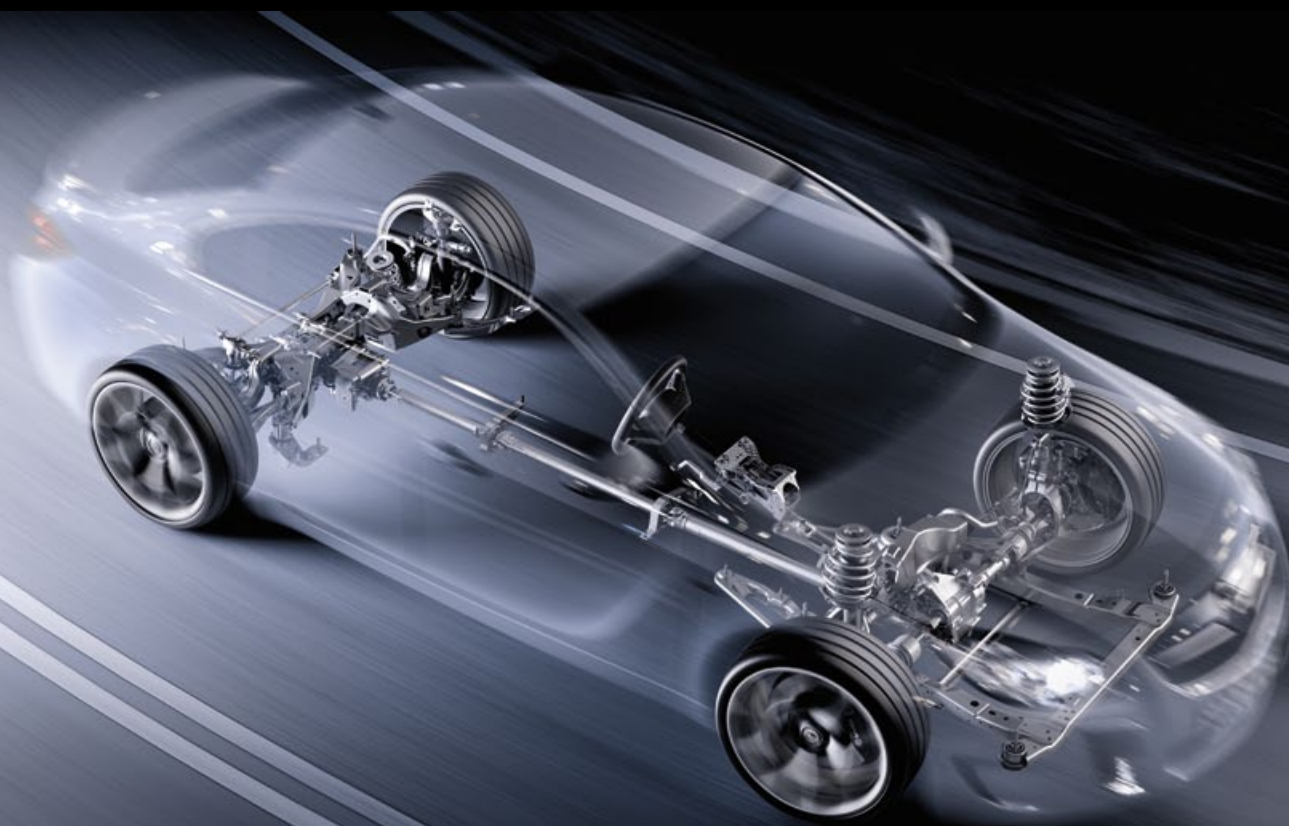

Insignia Electronic Limited Slip Differential (eLSD). The electronic Limited Slip Differential (eLSD) is fitted as standard to the rear of the Insignia VXR offering even more benefits for the enthusiastic driver. By sensing which rear wheel has the most grip, eLSD can transfer more torque to the wheel most able to utilise it. Up to 50% of the rear axle torque can be transferred between the rear wheels, increasing stability during high speed lane changes and providing more traction when accelerating out of corners.

2. FlexRide (Adaptive Stability Technology). The Astra and Insignia VXR models feature FlexRide – providing three different driving modes: ‘VXR’ for ultimate driving dynamics (tighter suspension, sharper throttle response and more direct steering) or ‘Sport’ for everyday sporty driving. ‘Normal’ is the default mode. The FlexRide adaptive chassis control system with Continuous Damper Control (CDC) monitors the roll, pitch and yaw of the car, and changes the rate of damping on each wheel to optimise the handling and selectively stiffens the suspension. This means the vehicle will exhibit a reduced rate of roll and pitch, making it more responsive during direction changes and more settled during the braking/turn-in/ acceleration transition when cornering. The FlexRide dampers contain magneto rheological (MR) fluid

– magnetic particles suspended in a synthetic fluid which change flow rate when a magnetic field is applied. Complex algorithms within the CDC system use acceleration, braking and cornering data to instantaneously adjust the electrical current applied to the electromagnetic coil within each damper – the higher the charge, the greater the damping resistance.



Limited Slip Differential (LSD). Limited Slip Differential (LSD). The Corsa VXR Nürburgring and Astra VXR respectively are the most powerful production Corsa and Astra models ever produced. And to assist putting their power onto the road, both these models have been equipped with a motorsport-derived Drexler Limited Slip Differential. Following extensive development the usual aggressive intervention from a front-wheel drive LSD has been re-tuned to provide outstanding traction and stability without affecting driver enjoyment.

These VXR's Drexler LSD uses of a series of clutch plates **1** that restricts significant differences in rotational speed between the front wheels limiting wheelspin and enhancing stability. Acceleration and deceleration cause pressure rings **2** next to the clutch plates to push sideways and compress the clutch stack – reducing the speed variation between the two driven wheels. Shaped cams on the differential axis **3** – reacting to differences in torque in the differential vary the amount of compression in the clutch stack – changing the amount of rotational difference between each wheel.

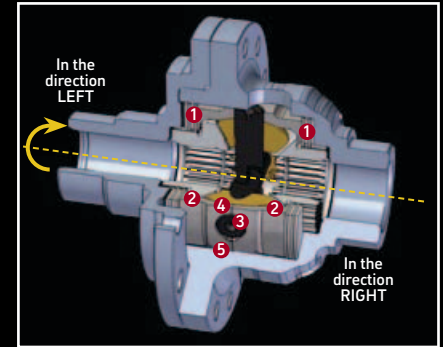

The speed of reaction and the amount of rotational difference are determined by the 'ramp angles' **4** **5** in the pressure rings. The lower the ramp angle, the higher the pressure applied to the clutch stack. On VXR the ramp angles are set-up to provide different characteristics under acceleration and deceleration.

➤ TECHNOLOGY EXPLAINED

1. Brembo braking systems. Corsa VXR Nürburgring and Astra and Insignia VXRs all feature a four-piston Brembo front braking system featuring larger diameter ventilated and on Astra and Insignia VXR, cross-drilled front discs. The cast iron discs are mounted on an aluminium centre reducing weight and improving performance. Combined with lighter caliper the new Brembo brakes are up to 30% lighter than the standard system. In each instance the new set-up also utilises high-performance pads which are also 10% larger – giving exceptional stopping power.

2. Reduced unsprung weight. Every aspect of a VXR has been considered when it comes to performance. On Astra and Insignia the HiPerStrut front suspension, 20-inch forged alloy wheels with Pirelli P Zero tyres and lightweight Brembo front brakes all combine to reduce unsprung weight by up to 7.5kg per front corner (Astra). This ensures better handling as the car can react more quickly to changes in the road surface improving grip and ride. Lighter wheels/tyres/brakes also require the engine to move less rotational mass – thus improving performance and economy.



3. Astra VXR Performance Seat Pack. The Astra VXR's lightweight performance front seats use composite technology to provide the optimum driver position, lateral location during cornering and ergonomic comfort. The injection moulded shells are formed from a composite of polyamide and fibreglass providing excellent strength and rigidity. Additional benefits include reduced weight (45 percent lighter) and reduced seat depth.

Both driver and front passenger seats are 40mm lower than the Astra Hatchback – helping reduce the VXR's centre of gravity. Despite their overt sporting characteristics the seats can be adjusted up to 18 ways, depending upon specification. Optional pneumatically adjustable side bolsters, provide the optimum lateral location, when ordered as part of the VXR Leather Seat or VXR Performance Seat Pack.



Left-hand drive seat illustrated.

➤ OPTIONS

There isn't much you can add to improve a VXR, but a range of extra-cost options is available just in case you want to personalise it a little further to suit your own needs. We've only included a sample of what's available here. The online Vauxhall Car and Accessory Price Guide has all the details.

1. Satellite navigation. Available for Astra and Insignia VXR. Find your way to anywhere, at any time. Satellite navigation can determine your location and guide you to your destination by the best and fastest route. The Traffic Message Channel (TMC) function can even change the route according to breaking traffic news.

2. Unlimited Pack. Test your Insignia with this new option. The top speed limiter is removed allowing a potential top speed of 170mph communicated via an increased range speedometer. Blue Brembo lettering on the brake calipers visually signify the upgrade.

3. Bluetooth® connectivity. Standard on Astra VXR, optional on both Corsa and Insignia VXR, the system enables your mobile phone to interface with the infotainment unit for operation via the steering wheel control, fascia display or voice activation via Bluetooth®.

4. Infinity Sound System. Standard on Insignia and optional on Astra VXR, the system features a 7x45W amplifier and nine premium speakers the system digitises the audio signal so it can be fine tuned with Digital Sound Processing (DSP) for superb all-round sound reproduction under all driving conditions.



5



5. Corsa Touch and Connect. An intuitive touch-screen navigation system complete with USB connection and Bluetooth® connectivity featuring 4x20W per channel output and seven premium speakers.

VXR8 GTS

This is what you get when you start with a blank canvas. And a mission statement to redefine world-class performance saloon design. The Vauxhall VXR8 GTS. An aggressive new look but still with awe-inspiring performance DNA to match – a thundering 431PS, 6.2 litre V8 motor rockets it to 60mph in just 4.9 seconds. Monstrous disc brakes can stop it from the same speed in just 36 metres. And giant alloy wheels hide multi-link independent rear suspension controlled by the best in electronic active safety chassis control. Welcome to a totally new animal. The four-door muscle car. From Vauxhall.





EXHILARATING DESIGN

Take the wheel of the VXR8 GTS and enjoy the ultimate driving experience. Everything has been created to put the driver first. The performance front seats, the sports instruments and the flat-bottomed steering wheel all confirm this is a true driver's car. In other words, a VXR.

1. Performance fascia. The VXR8 GTS steering wheel means business – leather-covered and flat-bottomed with perforated grip zones and remote audio controls. The steering column is reach and rake adjustable too. Other features include a state-of-the-art infotainment system featuring CD player with USB connection and aux-in, integrated iPod support and Bluetooth® connectivity.

2. Electronic Climate Control (ECC). The dual-zone climate control system allows variable side-to-side temperature settings to be selected.

3. 4. Sports instrumentation. The VXR8 GTS sports instrumentation also features auxiliary gauges that display oil temperature, oil pressure and battery voltage. Vital information easily identified in the sight-line on top of the dash. Ergonomics that put the New VXR8 GTS driver instinctively in control.

5. Performance seats. VXR8 GTS's performance front seats have eight-way electrical adjustment plus lumbar support adjustment. Trimmed in Onyx leather, they also feature ergonomically enhanced side bolsters contoured for greater comfort and lateral support.



Interior features

- Electronic climate control with variable side-to-side temperature settings
- Electrically adjustable leather-covered sports front seats
- Enhanced Driver Interface (EDI) ⓘ see page 44
- Multi-function display panel
- Cruise control
- Sports pedals
- Leather-covered flat-bottomed sports steering wheel
- Steering wheel mounted controls for audio system, trip computer, Bluetooth®, and EDI
- Mobile phone system with Bluetooth® (does not include phone)
- Auxiliary gauges displaying oil temperature, oil pressure and battery voltage

Exterior dimensions mm (inches)

- Length 4988 (196.3)
- Height 1457 (57.3)
- Width including mirrors 1899 (74.7)

Insurance group (ABI recommended)

- 50 Group rating – 50U

5



➤ OUTSIDE OF THE ORDINARY

From the outside, the VXR8 GTS makes a bold statement. Its Shockwave graphic grille and wide lower air intake add to its already muscular exterior. Twin air scoops, vented front wings and a high performance rear spoiler seal the deal. But a VXR is not just about looks. A rear wheel drive, 6.2 litre V8 engine delivers an astonishing 431PS of power. A machine worthy of its VXR badge.

Exterior features

- Shockwave graphic grille and wide lower air intake **1.**
- Twin air scoops on bonnet **1.**
- Projector headlights and front fog lights for greater high beam range **1.**
- Aero-style vented front wings **2.**
- Sports LED rear 'afterburner' tail lights
- Twin-post rear spoiler **3.**
- Rear bumper incorporating shockwave graphic grille **4.**

Racing style. VXR8 GTS looks awesome – aerodynamic and aggressive – with aero-style vented front wings, shockwave-inspired front grille and a superflow high performance rear spoiler. The performance alloy wheels – 20x8.5” at the front and 20x9.5” rear – are fitted with specially developed Bridgestone tyres.



Engine, transmission and chassis. There's something about a V8 – the growl, the epic power and torque. And the LS3 6.2 litre engine is not your ordinary V8 either. Read the data. An almighty 431PS @ 6000rpm. 550Nm of torque @ 4600rpm. Solid-state direct fire ignition, with a high energy coil for every single cylinder. Tubular 4 into 2 into 1 extractor exhausts. And a grin from ear to ear every time you fire it up. To say nothing of the rush of adrenalin you'll experience from a chassis that now features launch control and performance suspension with magnetic ride control.



Engine

6.2 LS3 V8 petrol (6162cc)

Maximum power:

431PS (317kW) @ 6000rpm

Maximum torque:

550Nm (405 lb.ft.) @ 4600rpm

Bore/stroke: 103.9mm x 92.0mm

- Aluminium alloy cylinder block and high-flow cylinder heads
- High-flow intake manifold with acoustic shell
- Cast steel roller rocker arms, roller cam followers
- Cross-bolted five main bearings with six bolts per bearing cap
- Stainless steel, high performance exhaust system with dual tailpipes

Performance (manufacturer's figures)

Maximum speed (mph):

Man	Auto
155	155

Acceleration 0-60mph (secs):

4.9	5.0
-----	-----

Acceleration 50-70mph (secs):

(3rd gear) 2.6	N/A
----------------	-----

Fuel economy and emissions

mpg (litres/100km)

	Man	Auto
Urban driving:	14.4 (19.6)	14.4 (19.6)
Extra-urban driving:	28.8 (9.8)	27.4 (10.3)
Combined figure:	20.9 (13.5)	20.6 (13.7)
CO ₂ emissions:		
g/km	320	324

Chassis, suspension and brakes

- Variable-ratio power-assisted rack and pinion steering
- Performance suspension with MRC
 - see page 45
- MacPherson strut front suspension with progressive-rate front springs and anti-roll bar
- Fully independent multi-link rear suspension with progressive-rate springs
- Electronic Stability Programme (ESP) incorporating, ABS, EBD, EBA and TCS
- Launch control (manual models only)
 - see page 45
- Front ventilated disc brakes: 365mm diameter
- Rear ventilated disc brakes: 350mm diameter
- Front and rear brake calipers in red

Transmission

- Limited-slip differential
- Six-speed manual gearbox
- Gear ratios (manual): 1st – 3.01:1, 2nd – 2.07:1, 3rd – 1.43:1, 4th – 1.00:1, 5th – 0.71:1, 6th – 0.57:1, Final drive – 3.70:1
- Six-speed automatic transmission optional at extra cost
- Gear ratios (auto): 1st – 4.03:1, 2nd – 2.36:1, 3rd – 1.53:1, 4th – 1.15:1, 5th – 0.85:1, 6th – 0.67:1, Final drive – 3.27:1

Wheels and tyres

- 20-inch alloy wheels
- Specially developed Bridgestone tyres
- 245/35 R 20 ultra-low profile front tyres
- 275/30 R 20 ultra-low profile rear tyres
- Tyre pressure monitoring system
- Spare wheel

➤ VXR8 GTS CLUBSPORT AND MALOO

The VXR8 GTS has the ability to instinctively engage every facet of the vehicle's performance so you feel, not just think the driving experience. The VXR8 ClubSport Saloon and Wagon models and the awesome VXR8 Maloo embody that same philosophy.

Dynamic range. All three models are available to special order only and built to your specification. Both VXR8 ClubSport Saloon and Wagon models make a bold statement about who you are and your passion for driving. The VXR8 Maloo is a sport utility pick-up that is the ultimate expression of work hard play hard. With a unique 'sailplane' design falling directly behind the cockpit the aerodynamic VXR8 Maloo is one good looking and powerful workhorse.

Drawing their power from a 431PS 6.2 litre V8 power plant all three models feature a specification befitting the VXR badge – linear-control sports suspension, limited-slip differential, competition mode electronic stability programme, launch control and 19-inch sports alloy wheels.

The interiors too are not merely about looks, but in true VXR-style have been designed around total driver ergonomics featuring cloth-trimmed sports front seats with four-way electric driver's seat adjustment, dual-zone electronic climate control and the same complete infotainment package as the VXR8 GTS model.

For more details on specification, the range of enhanced options that are available and how to order one of these iconic muscle cars, please contact your VXR retailer or visit www.vxr.co.uk



Tonneau cover. As well as 1208 litres of load capacity there's a remote locking hard tonneau cover with illumination and alarm protection which will keep all your work gear (and your play gear) secure.



Rear styling. The 'Superflow' rear spoiler, shockwave inspired fascia mounted exhaust tips and sports rear LED tail lights give the VXR8 ClubSport saloon models a design edge that leaves others looking pedestrian.



Front styling. Both VXR8 ClubSport and Maloo feature LED daytime running lights and a performance bonnet with dual scoops.

VXR8 GTS ENHANCED DRIVER INTERFACE

Enhanced Driver Interface (EDI) is the centrepiece of the VXR8 GTS. Never before has the driving enthusiast been able to engage with their vehicle on this level. EDI connects with the onboard computer to constantly stream real-time vehicle dynamics and performance data to the touch-screen display.

Enhanced driver interface (EDI). With the touch of your finger EDI will allow you to display real-time performance data such as vehicle G-Forces, power and torque, and lap-times. If this is not enough, the real enthusiast can even download their track day data and analyse their performance using the MoTec i2 software provided.



Main menu. Navigate your way through EDI using the touch-screen or the EDI button on the steering wheel.



Driver. Driver screen keeps you close to key inputs such as RPM, accelerator and brake pedal positions, and gear position.

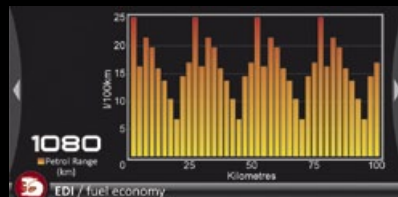

Fuel Economy. This screen displays the fuel economy history.



Stopwatch. Perfect for hill climbs, road rallies and your competitive instincts.



Gauges. Select your gauges for real-time information such as Power, Torque, Manifold Pressure, Fuel, Elevation, or Air Temp. (intake or external).



G-Force. Feeds live information on longitudinal and lateral G-Forces.



Dynamics. Understand your vehicle's behaviour with an understeer and oversteer display.



Data Logging. Download your recorded information onto a USB stick and review it later on your PC.

➤ VXR8 GTS CHASSIS DYNAMICS

For a passionate driver, nothing beats a car that is as unique as its driver. The VXR8 GTS comes with many exciting extras. Launch Control allows you to accelerate from a standstill at its maximum potential and a Magnetic Ride Control suspension system takes muscle car tuning to a whole new level enabling a dynamic blend of ride and handling that has never before been felt on a VXR.

Side Blind Zone Alert System (SBZA). Optional on the VXR8 range, the system monitors the surrounding traffic to keep the driver informed during lane changing situations. Multiple sensors around the car emit ultrasonic waves across key lane transition zones to keep you aware of any adjacent cars travelling in the same direction that may not always be visible in your mirrors.

Brakes. With monstrous front and rear brakes and wider rear tyres, the VXR8 GTS continues to deliver our best ever braking package. The VXR8 GTS brake calipers are finished in red embossed with a silver VXR logo.

Launch Control (manual vehicles). This system enables the vehicle to accelerate from standstill at its maximum potential. Launch control differs from traction control in that traction control focuses on vehicle stability (particularly in an emergency situation) whereas launch control focuses on providing control of the driven wheels to maximise acceleration during the initial set-off.



Magnetic Ride Control (MRC). Fitted as standard to the VXR8 GTS, Magnetic Ride Control (MRC) is a suspension system that integrates dynamic hardware with advanced software. With electronic control over suspension damping, the VXR8 GTS takes V8 muscle car suspension tuning to a new and exciting level. No longer confined to the limitations of conventional dampers (velocity sensitive damping), MRC is an intelligent control system that is able to take information from multiple inputs and calculate the desired level of damping in the blink of an eye. The result is a blend of ride and handling that has never before been felt on a VXR model. The MRC system features switchable ride control which enables 'Performance' and 'Track' modes. The finely tuned 'Performance' mode offers a sharper response with reduced body roll. For the ultimate driving sensation 'Track' mode, combined with 20" wheels, rides like a race tuned Supercar. MRC is a semi-active suspension technology with no electro-mechanical valves and no small moving parts, which provides for durability and reliability. As a result the VXR8 GTS driver not only benefits from increased performance, but safety, comfort and balance for positive stopping power. At the heart of MRC is a central controlling unit that updates each damper every 1000th of a second to the slightest change in road condition or driving style. The MRC-based semi-active suspension system consists of magneto rheological (MR) fluid-based monotube struts, monotube shock absorbers, a position sensor set and an onboard controller.

➤ RED VICTOR 3

Packing over 3000 horsepower from its 8.8 litre, twin-turbocharged GM V8 engine, 'Red Victor 3' – a highly modified version of an original 1972 VX4/90 Victor FD – heralds a new partnership between Vauxhall's VXR brand and the Red Victor 3 team in the MSA Pro-Modified Drag Series. Not only is the car capable of 240mph over the quarter mile but it gets there in just 6.5 seconds. And believe it or not it's still street legal!



The outrageous technical engine specification includes:

- 540ci (8.8 litre) GM Chevrolet V8
- Heads: billet aluminium GM Chevrolet c/w Ferrea titanium intake and super alloy exhaust valves. ARP fasteners, Cometic head gaskets, fabricated Moroso rocker covers
- Valvetrain: T+ D shaft rockers, PAC valve springs, Trend 7/16" pushrods
- Induction: twin Garrett GT55/91 ball bearing turbos, custom intake pipes, Wilson manifolds billet elbow and Wilson 105mm throttle body, Turbosmart BOV
- Exhaust: custom 321 stainless steel 2 1/4" diameter manifolds and 4.5" diameter silencers, all Zircotec ceramic coated, two Turbosmart 60mm wastegates
- Pistons: diamond custom c/w hard coat anodised and Teflon surface coating, Trend casidium coated pins, Total Seal gapless top piston rings
- Ignition: Pantera EFI individual coils run by a Motec M800 ECU, Magnecor R100 10mm spark plug leads, NGK racing spark plugs





COLOURS AND OPTIONAL TRIMS

VXR models are available in a range of great exterior colours, with complementary interior trim materials – fabric or leather – specially selected to reflect the range’s performance heritage.

Corsa VXR



Glacier White – Brilliant*



Flame Red – Solid



Silver Lake – Two-coat metallic*



Carbon Flash – Two-coat metallic*



Arden Blue – Two-coat pearlescent*

Corsa VXR Nürburgring Edition



Glacier White – Brilliant



Chilli Orange – Two-coat metallic*



Carbon Flash – Two-coat metallic*



Lime Green – Two-coat pearlescent*

Astra VXR



Power Red – Solid (two coat)



Summit White – Brilliant*



Arden Blue – Two-coat pearlescent*



Carbon Flash – Two-coat metallic*

*Optional at extra cost.

Due to the limitations of the printing process the colours reproduced may vary slightly from the actual paint colour and trim material. As a result they should be used as a guide only.



Corsa VXR. Standard: Charcoal Splice cloth with Morrocana-trimmed seat bolsters (illustrated on page 8).
Optional at extra cost: Leather Pack (illustrated above) comprising leather seat facings and heated front seats.

Corsa Nürburgring Edition.

Charcoal Splice cloth/Morrocana (illustrated on page 12).



Astra VXR. Standard: Jet Black Track cloth seat inserts with Cool Pearl stitching on Morrocana-trimmed seat bolsters (illustrated above).

Optional at extra cost: Jet Black Nappa soft leather seat inserts with Jet Black stripe and Cool Pearl stitching on seat bolsters (illustrated on page 17).

Jet Black Nappa soft leather seat inserts with Blue stripe and Blue stitching on seat bolsters (illustrated on page 17).

COLOURS AND OPTIONAL TRIMS

The Insignia and VXR8 are available in a range of striking exterior colours – specially selected to reflect it's performance pedigree.

Insignia VXR



Power Red – Solid (two-coat)



Summit White – Brilliant*



Carbon Flash – Two-coat metallic*



Silver Lake – Two-coat metallic*



Asteroid Grey – Two-coat metallic*



Arden Blue – Two-coat pearlescent*

VXR8 GTS



Heron White – Solid



Nitrate Silver – Two-coat metallic*



Perfect Blue – Two-coat metallic*



Chlorophyll – Two-coat metallic*



Sting Red – Solid



Phantom Black – Two-coat metallic*



Karma – Two-coat metallic*



Hazard Yellow – Solid†



Alto Grey – Two-coat metallic*



Sizzle – Two-coat metallic*

*Optional at extra cost.

†Not available for VXR8 ClubSport Wagon.

Due to the limitations of the printing process the colours reproduced may vary slightly from the actual paint colour and trim material. As a result they should be used as a guide only.



Insignia VXR. Standard: Track cloth/Morrocana (illustrated on page 24).
Optional at extra cost: Leather Pack (illustrated left) comprising perforated leather seat facings, eight-way electrically adjustable and heated front seats, dual-zone electronic climate control, electrically folding door mirrors and electro-chromatic anti-dazzle driver's door mirror.



VXR8. VXR8 GTS Onyx leather featuring performance front seats with eight-way electrical adjustment and lumbar support adjustment.

NEED MORE VXR?

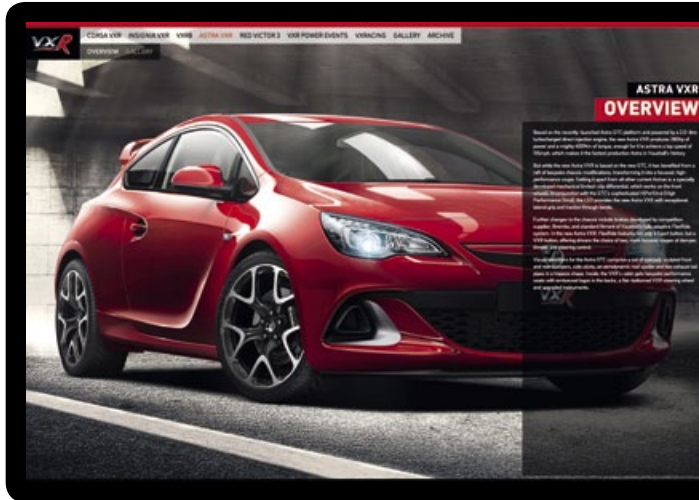

Then check us out online. We've just launched our brand new VXR website. To really immerse yourself in the VXR experience log-on and prepare to be blown away at: www.vxr.co.uk



Scan this QR code with your smartphone for more information. Don't forget to download a QR reader from your app store first.

Vauxhall Lifetime Warranty

We're so confident in Vauxhall quality and reliability that we are now able to offer a lifetime warranty. Available to the first owner of all new Vauxhall passenger cars, it's valid for the lifetime of the vehicle up to a maximum of 100,000 miles*. In addition, our warranty also includes Vauxhall Assistance for 12 months from first registration and six years body panel anti-perforation warranty. Full details of Vauxhall's warranties including terms, conditions and exclusions can be obtained through any authorised Vauxhall retailer or go to: www.vauxhall.co.uk/warranty

LIFETIME
WARRANTY 100,000 MILE



Proud Sponsor of Home Nations Football



*Vauxhall Lifetime Warranty covers lifetime ownership of first car owner, 100,000 mile limit, annual check required. The warranty excludes wear and tear and serviceable items and the vehicle must be serviced in accordance with the manufacturer's servicing schedule to continue the lifetime warranty. Terms and conditions apply. Offer available to all Vauxhall passenger cars (this offer does not apply to car-derived vans) from 1st August 2010.

Every effort has been made to ensure that the contents of this publication were accurate and up-to-date at the time of going to press (October 2012). Vauxhall vehicles are equipped with components manufactured by various General Motors operating units and outside suppliers. The Company reserves the right to alter specifications and withdraw products from sale without notice. Any such alterations will be notified to Vauxhall retailers at the earliest opportunity, please consult your local retailer for the latest information. The specifications detailed within this brochure are not necessarily applicable to alternative models such as Special Editions. Details of any such models will be contained in specific literature or found on the Vauxhall website. Please note that Vauxhall retailers are not the agents of General Motors UK Limited and are not authorised to bind the Company by any specific or implied undertaking or representation. It is advisable to ensure that your motor insurance policy provides adequate cover for additional fitted options and accessories. Please note accessories shown are for illustrative purposes only. As part of Vauxhall's policy of environmental care, this brochure is printed on paper manufactured using Elemental Chlorine Free pulps from specially farmed, sustainable timber resources. All rights reserved. No part of this publication may be reproduced in any form or by any means, without the prior written permission of General Motors UK Limited.



VAUXHALL