

# ZAFIRA

2012 Models Edition 1



Proud Sponsor of Home Nations Football





# make the world adjust to you

Zafira shows what can be achieved with clever thinking. All that dynamic driving experience, interior comfort and built-in seven-seater flexibility – but with sharp styling, cool interior finishes and impressive safety features.

*This brochure covers Expression, Life, Exclusiv, Design and Elite models only. Some of the vehicles shown in this brochure include options and accessories available at extra cost. And not all of the features described are available on every model. So please check the Equipment section for further details. From time to time, we also offer alternative Zafira models such as Special Editions, featured in their own separate literature or found on the Vauxhall website [www.vauxhall.co.uk](http://www.vauxhall.co.uk)*

**LIFETIME**  
WARRANTY 100,000 MILE

Exterior styling	4
Interior comfort	6
Flex7® seating	8
Environmental issues	10
Driving dynamics	12
Safety and security	14
Interior features	16
Model line-up	18
Accessories	22
Colours and trims	24
Equipment	26
Technical data	32

Please see back cover for more details.

# always cruise in style

Fed up with boxy looking MPVs? Here's a welcome change. A seven-seater compact people carrier that's definitely got the X-factor. With its radical, tapered roofline, dynamic front grille and bumper shapes, chrome headlight surrounds and great alloy wheel designs too, family travel has never been so attractive.







## real comfort wherever you sit

Zafira's design themes move effortlessly from outside to inside with a driver-friendly fascia and high quality interior finishes throughout. And while it's easy for the driver to get comfortable, this is a car designed to make travel easy for the whole family. So it's light and spacious, comfortable and clever – wherever you're sitting.





## space for a quality lifestyle

This is what versatility looks like. And it's all down to clever design – Flex7<sup>®</sup> seating, adaptable luggage space and plenty of smart storage ideas for all your essential travelling kit.









Zafira Exclusiv

# respect your world

We all share a responsibility to look after our world. That's why Vauxhall has been at the forefront of green automotive initiatives for many years. Most recently, we have been researching ways of developing new cars that are more efficient than ever before. The forthcoming Vauxhall Ampera\* is an Extended-Range Electric Vehicle (E-REV) that can drive up to 50 miles on battery power alone and over 300 miles utilising an on-board electric generator system. And of course, we are always looking to reduce vehicle CO<sub>2</sub> emissions and the Zafira 1.7CDTi 16v ecoFLEX models have among the lowest CO<sub>2</sub> emissions of any seven-seat MPV.

But our commitment to your continuing peace of mind goes even further. We have dramatically reduced manufacturing emissions, and our new models use more recycled materials and more recyclable parts than ever before.

We also offer free and easily accessible, environmentally friendly, end-of-life vehicle disposal through our partners Autogreen Ltd.

That way, we reduce our environmental impact in every phase of every vehicle's life cycle. Because your world is our world, too.



\*For more information on Vauxhall Ampera please visit [www.vauxhall-ampera.co.uk](http://www.vauxhall-ampera.co.uk)

ecoFLEX

Zafira's lowest emission ecoFLEX engines clearly demonstrate that environmental awareness can be achieved without compromising performance and driveability. Improved fuel economy speaks for itself but lower CO<sub>2</sub> emissions also save you money on Vehicle Excise Duty (VED) and company car taxation. See the table to the right for more details.



 **ESP-plus.** Especially useful on wet roundabouts and greasy roads or whenever a slippery surface catches you out, Electronic Stability Programme-plus (ESP-plus), senses if the car starts to slide on a bend and applies corrective braking to the appropriate wheels to help you regain control.



 **Six-speed.** Zafira comes with a six-speed manual gearbox as standard on all 1.7CDTi 16v engines. Petrol models come with a five-speed manual as standard.

**Petrol engines.** Zafira's twin-cam 1.6i 16v VVT and 140PS 1.8i 16v VVT Euro 5 engines feature multi-point sequential fuel injection and utilise Double Continuous Variable Cam Phasing (DCVCP), which provides most of the available torque across a wide rev band. The result? More power, lower fuel consumption and improved CO<sub>2</sub> emissions.

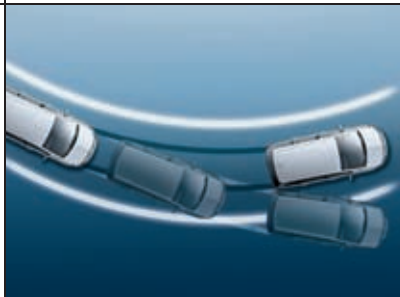

	Combined fuel economy mpg (litres/100km)	CO <sub>2</sub> emissions (g/km)	VED (2011/12)*		Benefit in kind tax band** (2011/12 tax year)
			First year	Standard	
<b>Petrol</b>					
1.6i 16v VVT	42.2 (6.7)	157	£165	£165	21%
1.8i 16v VVT	39.2 (7.2)	168	£265	£190	23%
<b>Diesel</b>					
1.7CDTi 16v (110PS) ecoFLEX	55.4 (5.1)	134	£115	£115	19%
1.7CDTi 16v (125PS) ecoFLEX	55.4 (5.1)	134	£115	£115	19%

**ecoFLEX diesels.** Zafira's two turbo diesel ecoFLEX models – a 1.7CDTi 16v (110PS) and 1.7CDTi 16v (125PS) have CO<sub>2</sub> emission figures of only 134g/km. Not only do they save you money with lower Vehicle Excise Duty (VED) charges and benefit in kind company car tax (see table left), but they do so without compromising the excellent driveability and performance Zafira is renowned for.

\*Correct at time of publication (September 2011). \*\*Taxation information for guidance only. Please take professional advice on your own tax position.

## Intelligent, reassuring safety and security

Zafira has a strong reputation for safety and security, and with good reason. Every model has a five star EuroNCAP adult occupant safety rating, with six full-size airbags and a chassis that is packed with active safety innovations that help you avoid accidents before they happen. Security features include remote control central deadlocking.





**Remote control alarm system.**  
The ultrasonic security alarm system features forced entry detection, along with tilt, movement and rear glass breakage sensors. Optional at extra cost (not available on Expression models).

**Adaptive Forward Lighting (AFL).**

The optional lighting system swivels the headlight beams up to 15 degrees for improved vision as you turn a corner. Above 65mph, it raises the dipped headlight beam slightly, also to increase safety – returning to normal beam automatically as speed is reduced.

**Anti-lock Braking System (ABS).**

On its own, ABS is a huge benefit in emergency braking, but Zafira goes even further. Emergency Brake Assist (EBA), Electronic Brakeforce Distribution (EBD) and Cornering Brake Control (CBC) all make the car easier to control and stop under extreme cornering and braking.

**ISOFIX Child seat restraint system.**

The rigid ISOFIX anchoring mechanism virtually eliminates the dangers of incorrect child seat installation. You simply click the optional accessory Vauxhall ISOFIX child seat into the mounting points engineered into the Zafira outer rear second-row seats.



**Six airbags.** Zafira protects you and your family with six full-size airbags as standard on every model. Specially developed to provide maximum protection, every model has twin front airbags, enlarged 'thorax-pelvis' front seat side-impact airbags and full-size curtain airbags too.



## Keeping everybody happy

Zafira's Flex7<sup>®</sup> seating. It's not just about quantity. It's about quality too, making everyone feel comfortable – front and rear. Wherever you're sitting, you'll be amazed at what Zafira has to offer, whether it's features like air conditioning or clever storage space for all your bits and bobs.





▼ **Quality sounds.** Every Zafira features a quality CD player/stereo radio, with steering wheel mounted audio controls on many models. Optional upgrades include digital radio, CD/MP3 format, aux-in or CD autochanger.



▼ **Cruise control.** The easy-to-use, tap-up/tap-down cruise control is standard on Elite and optional on most other models. It allows you to maintain a steady speed without keeping your foot on the throttle. So it's more comfortable on long journeys and easier to keep to speed limits too.

▲ **Air conditioning.** It makes for a fresher interior atmosphere all year round, with chilled air on hot days and faster demisting when it's damp. Move up to Electronic Climate Control (ECC), standard on Elite and optional on Exclusiv, and you can maintain the interior temperature to within a single degree.



◀ ▶ **Versatile load space.**  
When you're not using Zafira's third row seats, there's no need to remove them completely. Each one folds down separately, flush with the load floor. Add the optional FlexOrganiser® pack, and you've got the smartest, most versatile way to manage your load area ever!



▲ **Mobile phone system with Bluetooth®\*.** With the optional mobile phone system, your phone interfaces with the audio unit, for operation via the steering wheel controls and facia display. Bluetooth® wireless technology with voice activation is included. See page 31 for more detailed information.

**Multi-function trip computer.**  
Standard on Zafira Design and Elite this invaluable driver information system provides instantaneous and average fuel consumption, fuel consumed, average speed, distance travelled and range based on fuel remaining.



\*Please refer to the online Vauxhall Car and Accessory Price Guide for a list of phone-specific cradles.

**EXPRESSION AND LIFE**

**Standard features include:**

- Anti-lock braking system
- Power-assisted steering
- Twin front airbags
- Electronic Stability Programme-plus (ESP-plus) with traction control
- Front seat side-impact airbags
- Full-size curtain airbags
- Driver's seat height adjuster
- Electric door mirrors
- Electric front windows
- Remote control central deadlocking
- Steering wheel adjustable for reach and rake
- Air conditioning (Life models only\*)
- CD player/stereo radio (CD 30)
- 12-volt auxiliary power socket located in luggage compartment
- Black roof rails (Life models only)



Engine availability	Insurance groups (ABI)
<b>Expression</b>	
1.6i 16v VVT	12E
<b>Life</b>	
1.6i 16v VVT	13E
1.8i 16v VVT	15E
1.7CDTi 16v (110PS) ecoFLEX	14E
1.7CDTi 16v (125PS) ecoFLEX	17E

\*Non-air conditioned 1.6i 16v model also available

Life model interior illustrated.

Please note: Insurance groups relate to the 50 group rating.



## EXCLUSIV

### Standard features include:

- Anti-lock braking system
- Twin front airbags
- Front seat side-impact airbags
- Full-size curtain airbags
- Driver's seat height adjuster
- Electric front windows
- Remote control central deadlocking
- Steering wheel adjustable for reach and rake
- Air conditioning
- CD player/stereo radio (CD 30)

### Additional features over and above Life model include:

- 16-inch Structure wheels
- Leather-covered three-spoke steering wheel
- Steering wheel mounted audio controls
- Piano black-effect centre console
- Electrically adjustable/heated door mirrors
- Dark-tinted rear glass
- Body-colour door handles and side-protection mouldings

Engine availability	Insurance groups (ABI)
1.6i 16v VVT	12E
1.8i 16v VVT	15E
1.7CDTi 16v (110PS) ecoFLEX	14E
1.7CDTi 16v (125PS) ecoFLEX	17E



Please note: Insurance groups relate to the 50 group rating.

Model illustrated features two-coat metallic paint, optional at extra cost.

Exclusiv

**DESIGN**

**Standard features include:**

- Anti-lock braking system
- Twin front airbags
- Front seat side-impact airbags
- Full-size curtain airbags
- Electric front windows
- Dark-tinted rear glass
- Remote control central deadlocking
- Leather-covered three-spoke steering wheel
- Steering wheel adjustable for reach and rake
- Air conditioning
- CD player/stereo radio (CD 30)

**Additional features over and above Exclusiv model include:**

- 16-inch seven twin-spoke alloy wheels
- Front fog lights
- Multi-function trip computer
- Electric rear windows
- Driver's armrest
- Driver's seat with tilt and lumbar adjustment
- Rain-sensitive windscreen wipers
- Alloy-effect roof rails



Engine availability	Insurance groups (ABI)
1.6i 16v VVT	15E
1.8i 16v VVT	15E
1.7CDTi 16v (110PS) ecoFLEX	14E
1.7CDTi 16v (125PS) ecoFLEX	17E

*Model illustrated features two-coat metallic paint, optional at extra cost.*

*Please note: Insurance groups relate to the 50 group rating.*



## ELITE

### Standard features include:

- Anti-lock braking system
- 16-inch seven twin-spoke alloy wheels
- Six airbags
- Electric front and rear windows
- Dark-tinted rear glass
- Multi-function trip computer
- Driver's armrest
- Leather-covered three-spoke steering wheel
- Rain-sensitive windscreen wipers
- Alloy-effect roof rails

### Additional features over and above Design model include:

- Leather seat facings on front and second row seats (third row seats trimmed in Morrocana)
- Electrically heated sports front seats with tilt and lumbar adjustment
- Electronic climate control
- Cruise control
- CD/MP3 CD player/aux-in/stereo radio (CD 30 MP3)

### Engine availability

### Insurance groups (ABI)

1.8i 16v VVT	16E
1.7CDTi 16v (110PS) ecoFLEX	15E
1.7CDTi 16v (125PS) ecoFLEX	18E

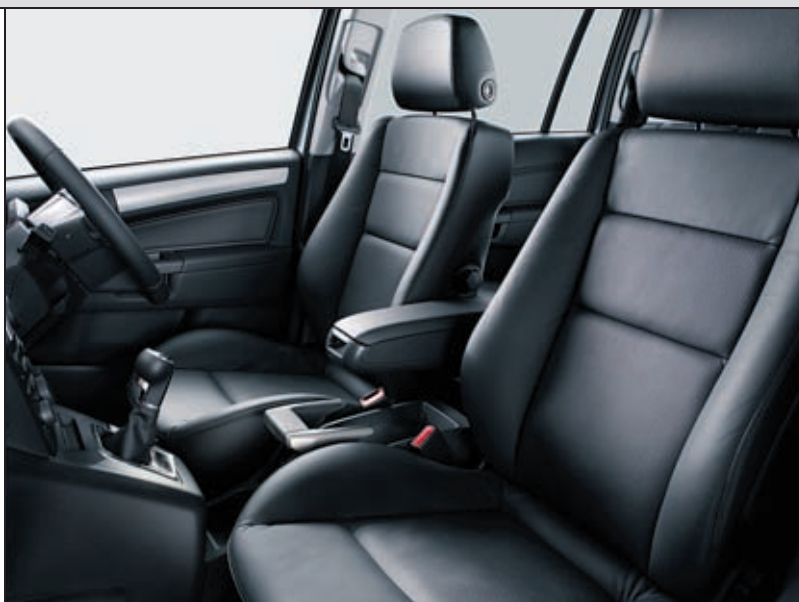

Please note: Insurance groups relate to the 50 group rating.

Model illustrated features two-coat metallic paint, optional at extra cost.

Genuine Vauxhall Accessories are the right choice for your Zafira. Whatever you're into, there's certain to be a Vauxhall accessory with your name on it; all fitted by trained Vauxhall professionals. We've only featured a small selection of what's available here, so please check with your Vauxhall retailer for accessory availability information or visit our website at [www.vauxhall.co.uk/accessories](http://www.vauxhall.co.uk/accessories)



**▲ Floor mats.** A range of floor mats including rubber, velour and deluxe velour are available for your Zafira. Each come with their own fixing points which help keep them firmly in place. The rubber mats are available as a front pair or set of four rears whilst all other variants are supplied in sets of six.

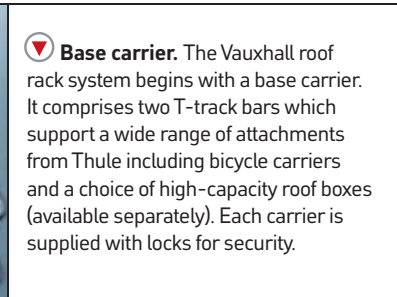

**▼ Base carrier.** The Vauxhall roof rack system begins with a base carrier. It comprises two T-track bars which support a wide range of attachments from Thule including bicycle carriers and a choice of high-capacity roof boxes (available separately). Each carrier is supplied with locks for security.



**▶ Rear parking distance sensors.** Activated automatically as you select reverse, this clever system beeps faster the closer you get to an obstruction, changing to a continuous tone at 300mm away.

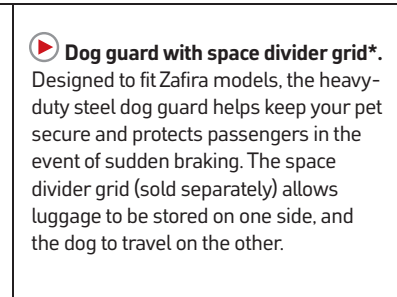

**▶ Dog guard with space divider grid\*.** Designed to fit Zafira models, the heavy-duty steel dog guard helps keep your pet secure and protects passengers in the event of sudden braking. The space divider grid (sold separately) allows luggage to be stored on one side, and the dog to travel on the other.



*\*The space divider grid can only be used in conjunction with the dog guard. N.B. Dog guard requires fitting kit (retailer-fit only) if vehicle is not equipped with the optional factory-fit vertical load restraining net.*

**FURTHER ACCESSORIES AVAILABLE INCLUDE:**

- Thatcham approved alarm system
- Cargo liner
- Mudflaps
- Headlight protectors
- Electrically chilled 12-litre cool bag
- Thule bike carrier
- Thule alloy ski carrier
- Tow bar
- Anti-slip mat
- Steering wheel security bar
- Child seats
- Privacy shades
- Alloy wheels



## VAUXHALL ACCESSORY PACKS

Vauxhall accessory packs bring together a selection of essential accessories at great prices, helping you to protect your car and equipping you for roadside emergencies.



Now you are able to browse all of the Genuine Vauxhall Accessories range with just the click of a button. Scan this QR code with your smartphone for more information. Don't forget to download a QR reader from your app store first.

### **Protection Pack.**

- Velour mats
- Mudflaps
- Cargo liner



### **Safety Pack.**

- First aid kit
- Warning triangle
- Hi-visibility vest



## Styling

Developed in conjunction with auto design specialists Irmischer International, Zafira styling accessories perfectly complement the vehicle's lines, as well as being manufactured to the same exacting standards as the car itself.

### **Irmischer sports silencers.**

For distinctive looks (with chrome-plated tailpipes) and a sportier exhaust note, these split oval design tailpipes are the perfect choice for your Zafira.



 **Irmischer alloy wheels.** They're the perfect way to personalise your Zafira. With a huge range to choose from (style illustrated is Stila), and sizes from 16 to 19 inches, you're sure to find one to suit your style and budget. And don't forget to ask about our accessory wheel locking kits too.

 **Cross hatch grille.** Being different is easy with the cross hatch front grille from Irmischer. Featuring an aluminium upper strip with a laser-etched 'Irmischer' logo it adds style and individuality.



Zafira comes in 7 different exterior colours. And each one suits the car beautifully. Every trim combination – cloth or leather – has been carefully selected to complement whatever colour you choose.

Royal Blue – solid



Power Red – solid (two-coat)



Olympic White – brilliant\*



Sovereign Silver – metallic\*



Technical Grey – metallic\*



Carbon Flash – metallic\*



Waterworld – pearlescent\*



*Due to the limitations of the printing process the colours reproduced may vary slightly from the actual paint colour or trim material. As a result they should be used as a guide only. Vehicle illustrated is a non-specific model. Your Vauxhall retailer has a comprehensive display of all our paint samples and trim swatches.*





◀ Alpha cloth - Charcoal  
EXPRESSION/LIFE



◀ Twist cloth - Charcoal  
EXCLUSIV

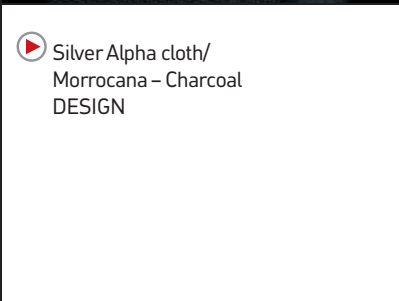

▶ Silver Alpha cloth/  
Morrocana - Charcoal  
DESIGN



▶ Leather - Charcoal\*\*  
ELITE

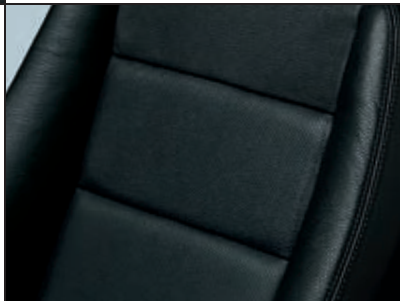

\*Optional at extra cost. Not available on Expression models.

\*\*Leather facings on front and second row seats. Third row seats trimmed in Morrocana.

## Contents

### Equipment

Safety	26
Security	
Facia, instruments and controls	

Seating and upholstery	27
Interior features	

Mechanical	28
Exterior and convenience features	

Packs	29
-------	----

Wheels and tyres	30
Audio and communication	

### Technical data

Engines	32
---------	----

Performance, fuel economy and emissions	33
---	----

Vauxhall Assistance and warranties	34
------------------------------------	----

Steering	
----------	--

Brakes	
--------	--

Body	
------	--

Fuel tank capacity	
--------------------	--

Suspension	
------------	--

Weights and towing data	
-------------------------	--

Exterior dimensions	35
---------------------	----

Luggage capacities	
--------------------	--

Loadspace dimensions	
----------------------	--

## Safety

**Standard features** • Driver's and front passenger's airbags • Full-size curtain airbags (front and second-row seating) • Front seat side-impact airbags • Pedal release system – Reduces potential injury to the driver's legs and feet during a severe frontal impact • Laminated windscreen • Side-impact protection beams • Energy-absorbing steering column

• Child-proof locks on rear doors • ISOFIX child seat restraint system for outer second-row seats incorporating top tether (does not include child seat) – Secures ISOFIX child safety seats to the vehicle itself, virtually eliminating the dangers that can result from improper installation

• Electronic Stability Programme-plus (ESP-plus) with traction control • Anti-lock Braking System (ABS) • Electronic Brakeforce Distribution (EBD) • Cornering Brake Control (CBC) • Emergency Brake Assist (EBA)

• Pyrotechnic front body-lock seatbelt pretensioner system – Tightens the seatbelt during the early stages of a frontal impact • Front seatbelt force limiters – Reduce the loading on the occupants' chests by releasing the belts very slightly, if the force exceeds a specified limit, in a frontal impact • Height-adjustable head restraints on all seats • Inertia-reel lap and diagonal seatbelts on all seats

## Security

**Standard features** • Remote control central deadlocking (doors, tailgate and fuel flap) • 'Key left in ignition' audible warning • Electronic engine deadlock immobiliser • Locking wheel bolts for alloy wheels (where fitted) • Electronic theft protection for audio equipment

<b>Additional features</b>	Exp.	Life	Excl.	Design	Elite
Keyless entry and start system			○	○	○
Remote control ultrasonic security alarm system		○ <sup>1</sup>	○	○	○

## Facia, instruments and controls

**Standard features** • Steering column adjustable for reach and rake • Rev counter • Electronic odometer and trip odometer • Digital clock with automatic RDS time adjustment • Service-due indicator • Multi-function display panel showing time, date, audio information and outside air temperature (with ice warning function) • 12-volt electrical accessory socket • Black instrument dials

<b>Additional features</b>	Exp.	Life	Excl.	Design	Elite
Multi-function trip computer				●	●
Three-spoke steering wheel	●	●			
Leather-covered three-spoke steering wheel			●	●	●
Cruise control			○	○	●

## Seating and upholstery (see page 25 for more details)

**Standard features** • Flex7® seating system • Reclining front seats • Driver's seat height adjuster • 40/20/40 split-folding second-row seat back • Second-row seats with sliding function plus fold and stow facility • Multi-function fold-down second-row centre seat • Two individual fold-flat third-row seats • Carpeted passenger compartment, load area floor and rear seat backs

<b>Additional features</b>	Exp.	Life	Excl.	Design	Elite
Alpha cloth seat trim	●	●			
Twist cloth seat trim			●		
Silver Alpha cloth seat trim with Morrocana-trimmed side bolsters				●	
Leather seat facings on front and second-row seats, Morrocana seat facings on third-row seats					●
Sports front seats					●
Driver's seat with tilt and lumbar adjustment			□	●	●
Front passenger's seat with tilt and lumbar adjustment			□	□	●
Driver's armrest				●	●
Heated front seats					●
Storage pockets on front seat backs			●	●	●

## Interior features

**Standard features** • Air blend heater with four-speed fan and illuminated controls • Interior pollen filter • Interior odour-reducing activated charcoal filter • Air recirculation system with activation light • Second-row passenger compartment heating outlets • Drinks holder in centre console • Front and rear door pockets • Front sill storage bins • Drinks holders in second-row door pockets and third-row seat side armrests • Latched storage lockers in luggage compartment • 12-volt auxiliary power socket in luggage compartment • Retractable luggage compartment cover

<b>Additional features</b>	Exp.	Life	Excl.	Design	Elite
Air conditioning		● <sup>2</sup>	●	●	
Electronic Climate Control (ECC) with graphic information display			○		●
Third-row passenger compartment reading lights and front map-reading lights integral with courtesy light			●	●	●
Charcoal-effect inserts on facia and doors	●	●			
Matt chrome-effect centre console	●	●			
Matt chrome-effect inserts on facia and doors			●		
Piano black-effect centre console			●	●	●
Satin chrome-effect inserts on facia and doors				●	●
Brushed aluminium door sill covers				●	●
Electro-chromatic anti-dazzle rear-view mirror				●	●
Driver's sunglasses holder				●	●
Vertical load-restraining net	○	○	○	○	○



Cruise control.

● = Standard equipment  
○ = Optional at extra cost  
□ = Only available as part of an extra-cost option pack (see page 29 for details).

Exp. = Expression.  
Excl. = Exclusiv.

1 = Includes map reading light, sunvisors with illuminated vanity mirrors and rear reading lights.  
2 = Non-air conditioned 1.6i 1.6i VVT models also available.



Folding key.



Front fog lights.

## Mechanical

### Features

	Exp.	Life	Excl.	Design	Elite
Five-speed manual gearbox (1.6i 16v VVT/1.8i 16v VVT)	●	●	●	●	●
Six-speed manual gearbox (1.7CDTi 16v (110PS)/1.7CDTi 16v (125PS))		●	●	●	●

### Exterior and convenience features

**Standard features** ● Green-tinted glass ● Electrically operated front windows with safety autoreverse and one-touch facility ● Intermittent rear window wash/wipe ● Electrically adjustable door mirrors ● Electric headlight beam levelling ● H7 halogen headlights ● Body-colour door mirrors ● Body-colour bumpers

### Additional features

	Exp.	Life	Excl.	Design	Elite
Folding key			●	●	●
Rain-sensitive windscreen wipers/Automatic Lighting Control (ALC)				●	●
Dark-tinted glass (excludes windscreen and front door windows)			●	●	●
Electrically operated rear windows with safety autoreverse				●	●
Black foil on door pillars (not available with Carbon Flash metallic paint)			●	●	●
Black roof rails <sup>3</sup>		●	●		
Alloy-effect roof rails <sup>3</sup>				●	●
Front fog lights				●	●
Electrically heated door mirrors			●	●	●
Electrically foldable door mirrors				○	○
Black side-protection mouldings	●	●			
Body-colour side-protection mouldings/door handles/tailgate handle			●	●	●
Dark-style headlights	●	●	●		
Chrome-effect headlights				●	●
Adaptive Forward Lighting (AFL) incorporating dark-style bi-xenon headlights with dynamic beam levelling and high-pressure headlight washers			○ <sup>4</sup>	○	○
Front and rear parking distance sensors			○	○	○

● = Standard equipment.  
○ = Optional at extra cost.  
Exp. = Expression.  
Excl. = Exclusiv.

<sup>3</sup> = Must be used with separate base carrier (available as a Vauxhall accessory) if luggage is to be carried on the roof.

<sup>4</sup> = AFL includes front fog lights on Exclusiv models.

<sup>5</sup> = Only available in conjunction with Seat Comfort Pack One.

## Packs

	Exp.	Life	Excl.	Design	Elite
<b>Seat Comfort Pack One</b> • Driver's seat with tilt and lumbar adjustment			○	●	●
<b>Seat Comfort Pack Two</b> • Front passenger's seat with tilt, height and lumbar adjustment			○ <sup>5</sup>	○	●
<b>FlexOrganiser® Pack</b> • 3D storage net • Side net pocket • Four side rail hooks • Four side rails			○	○	○
<b>Leather Pack</b> • Leather seat facings on front and second-row seats, Morrocana seat facings on third-row seats • Electrically heated sports front seats with tilt and lumbar adjustment • Front passenger's seat height adjuster					●

### Seat Comfort Pack One

- Driver's seat with tilt and lumbar adjustment



### Seat Comfort Pack Two<sup>5</sup>

- Front passenger's seat with tilt, height and lumbar adjustment



### FlexOrganiser® Pack

- 3D storage net
- Side net pocket
- Four side rail hooks
- Four side rails



### FlexOrganiser® accessories

Vauxhall also offers a range of FlexOrganiser® features as part of its comprehensive collection of accessories.

For details of FlexOrganiser® accessories, shown right, please consult your Vauxhall retailer.



### Leather Pack

- Leather seat facings on front and second-row seats, Morrocana seat facings on third-row seats
- Electrically heated sports front seats with tilt and lumbar adjustment
- Front passenger's seat height adjuster





Steering wheel mounted audio controls.

## Wheels and tyres

Features	Exp.	Life	Excl.	Design	Elite
16-inch steel wheels with flush covers and 205/55 R 16 ultra-low profile tyres	●	●			
16-inch Structure wheels with 205/55 R 16 ultra-low profile tyres			●		
16-inch seven twin-spoke alloy wheels with 205/55 R 16 ultra-low profile tyres and locking bolts				●	●
Steel spare wheel (deletes 12-volt auxiliary power socket in luggage compartment)	○	○	○	○	○
Emergency tyre inflation kit in lieu of spare wheel	●	●	●	●	●

## Audio and communication

Features	Exp.	Life	Excl.	Design	Elite
<b>CD player/stereo radio (CD 30)</b> ● CD player ● AM/FM stereo radio with 24 station presets ● RDS with Traffic Programme ● Remote display ● 17 watts per channel output ● 6 speakers	●	●	●	●	
<b>CD/MP3 CD player/stereo radio (CD 30 MP3)</b> ● CD/MP3 CD player ● Aux-in ● AM/FM stereo radio with 24 station presets ● RDS with Traffic Programme ● Remote display ● 20 watts per channel output ● 7 speakers		○	○	○	●
<b>CD/MP3 CD autochanger/DAB stereo radio (CDC 40 DAB)</b> (deletes aux-in, where fitted) ● Integral six-disc CD/MP3 CD autochanger ● AM/FM/DAB (Digital Audio Broadcast) stereo radio with 36 station presets ● RDS with Traffic Programme ● Remote graphic information display ● 35 watts per channel output ● 7 speakers			○	○	○
Mobile phone system with Bluetooth® (does not include phone or cradle)		○ <sup>6</sup>	○	○	○
Steering wheel mounted audio controls			●	●	●
Roof-mounted flexible aerial	●	●	●	●	●

- = Standard equipment.
- = Optional at extra cost.
- Exp. = Expression.
- Excl. = Exclusiv.

6 = Includes map reading light, sunvisors with illuminated vanity mirrors, rear reading lights and steering wheel mounted audio controls.

### Digital Audio Broadcast (DAB) facility

Now widely available in the UK, digital audio broadcasts offer the user a variety of advantages over traditional FM, starting with the digital quality sound which is immune to any hiss or crackle.

You'll often find a broader range of stations on offer too, many of which are not available on FM, and listening to them couldn't be easier – you simply select the station, by name, from the displayed list, thus removing the need to retune or look for stations when travelling around. Some stations will even display the artists' names and song titles on the car's graphic display, while they're played.

### MP3 CD player

An MP3 is a compressed sound or music file and, due to its small size, it takes up less space on a compact disc, which means that more tracks can be recorded onto a CD. It's possible to fit almost 10 hours of music onto one CD, and, in a way, turns a single-disc CD/MP3 player into a multi-disc autochanger.

### Mobile phone system with Bluetooth®

Vauxhall's optional factory-fit dual-band mobile phone system has been considerably enhanced. Now fully integrated into the audio and communication system, it also features voice control and will connect wirelessly to phones with Bluetooth® technology.

All the required information is displayed on the graphic information display when a mobile phone is in use, while the menus are easily navigated by either the steering wheel audio controls or the multi-function button on the radio. Certain functions can also be controlled by voice activation.

The mobile phone system can be further enhanced by fitting a phone-specific cradle, available as a Vauxhall Accessory. The cradle offers a secure location for your phone, while simultaneously charging the phone's battery and connecting its antenna to the car's external aerial. A list of compatible cradles is featured in the online Vauxhall Car and Accessory Price Guide.

### Aux-in

The aux-in allows you to connect your portable MP3 music player directly into the car's audio system. All you need is your music player and a suitable connecting lead and you can listen to all your favourite tunes through your car's speaker system.

When using an MP3 player in the car the majority of the controls, such as track selection, remain solely on the player, while only the volume is controlled via the car's regular audio controls.

**NB:** Aux-in is not available in conjunction with CDC 40 DAB audio unit.



*Mobile phone system with Bluetooth®.*



High-performance petrol engines.



**55.4mpg**

1.7CDTi 16v  
ecoFLEX engine  
offers great  
economy and low  
emissions

### Petrol engines

	1.6i 16v VVT ECOTEC-4	1.8i 16v VVT ECOTEC-4
Capacity	1598cc	1796cc
Maximum power	115PS (85kW) @ 6000rpm	140PS (103kW) @ 6300rpm
Maximum torque	155Nm (114 lb.ft.) @ 4000rpm	175Nm (129 lb.ft.) @ 3800rpm
Configuration	4 cylinders, 4 valves per cylinder, double overhead camshafts	
Fuel/induction system	Naturally aspirated Variable Valve Timing (VVT). Multi-point sequential fuel injection	
Emission compliance	Euro 5	
Service intervals	20,000 miles or 1 year (whichever occurs sooner)	
<i>Benefit in kind company car taxation – 2011/12 tax year</i>		
Manual	21%	23%

### Diesel engines

	1.7CDTi 16v (110PS) ECOTEC-4 Turbo diesel with DPF	1.7CDTi (125PS) ECOTEC-4 Turbo diesel with DPF
Capacity	1686cc	1686cc
Maximum power	110PS (81kW) @ 3800rpm	125PS (92kW) @ 4000rpm
Maximum torque	260Nm (192 lb.ft.) @ 2300rpm	280Nm (206 lb.ft.) @ 2300rpm
Configuration	4 cylinders, 4 valves per cylinder, double overhead camshafts	
Fuel/induction system	Variable geometry turbocharger with intercooler. Common rail fuel injection	
Emission compliance	Euro 5	
Service intervals	20,000 miles or 1 year (whichever occurs sooner)	
<i>Benefit in kind company car taxation – 2011/12 tax year</i>		
Manual	19%	19%

DPF = Diesel Particulate Filter.



## Performance, fuel economy and emissions

Model	Performance (manufacturer's figures)			Fuel economy mpg (litres/100km)			CO <sub>2</sub> emissions (g/km)	VED*	
	Max. speed (mph)	Acceleration (secs) 0-60mph	30-50mph (4th gear)	Urban driving	Extra-urban driving	Combined figure		First year rate	Standard rate
<i>Manual 5-speed</i>									
1.6i 16v VVT	115	12.5	9.1	32.5 (8.7)	51.4 (5.5)	42.2 (6.7)	157	£165	£165
1.8i 16v VVT	122	10.8	8.1	29.4 (9.6)	49.6 (5.7)	39.2 (7.2)	168	£265	£190
<i>Manual 6-speed</i>									
1.7CDTi 16v (110PS) ecoFLEX	111	12.5	7.3	46.3 (6.1)	62.8 (4.5)	55.4 (5.1)	134	£115	£115
1.7CDTi 16v (125PS) ecoFLEX	117	11.5	6.7	46.3 (6.1)	62.8 (4.5)	55.4 (5.1)	134	£115	£115

\* = Correct at time of publication (September 2011).

Fuel consumption and CO<sub>2</sub> emission data complies with the relevant EU testing regulations used by vehicle manufacturers to enable comparisons between different models. **Important:** Please note fuel consumption can be affected by many factors including driving style, road and traffic conditions, vehicle mileage and standard of maintenance. In addition these results relate to the particular vehicle tested, inevitably there will be differences between individual vehicles of the same model.

### Vauxhall supporting



### Smarter driving tips

- **Drive at an appropriate speed:** Staying within the speed limit increases driver safety, reduces CO<sub>2</sub> emissions and saves fuel. At 70mph you could be using up to 9% more fuel than at 60mph and up to 15% more fuel than at 50mph
- **Drive smoothly at all times:** Anticipate the ebb and flow of the traffic to avoid harsh acceleration and braking

- **Reduce your revs:** Change gear earlier to help reduce fuel consumption – try 2500rpm with petrol engines and 2000rpm with diesel
- **Idling is wasting fuel:** If you're likely to be at a standstill for more than three minutes, switch off the engine to save fuel
- **Regularly check your tyre pressures:** Under inflated tyres increase CO<sub>2</sub> emissions whilst incorrectly inflated

tyres can be unsafe. Always check your handbook for the correct tyre pressure. This will also help to increase the life of your tyres

- **Remove unnecessary items from the car:** Extra weight increases the engine's workload, whilst roof racks and bike carriers increase wind resistance. All burn more fuel and increase CO<sub>2</sub> emissions

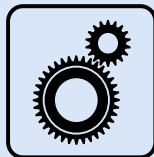

### 6-SPEED

Six-speed manual gearbox available



MacPherson strut front suspension.



### 1400kg

Maximum towing weight

### Steering

- Electro-hydraulic power-assisted steering
- Turning circle (kerb-to-kerb):  
All models – 11.10m (36.4ft.)

### Brakes

- Anti-lock Braking System (ABS)
- Dual circuit, diagonally split braking system

#### 1.6i 16v VVT

Front ventilated discs: 280mm diameter

Rear discs: 264mm diameter

#### 1.8i 16v VVT

Front ventilated discs: 280mm diameter

Rear discs: 264mm diameter

#### 1.7CDTi 16v (110/125PS)

Front ventilated discs: 308mm diameter

Rear discs: 264mm diameter

### Body

- Aerodynamic drag co-efficient: Cd 0.31

### Fuel tank capacity

- All models – 58 litres (12.8 gallons)

### Suspension

**Front:** Independent. Lightweight

MacPherson struts with gas-pressure dampers and coil springs. Anti-roll bar. Hydro-formed subframe offers increased lateral stiffness. Hydraulic control arm bushing gives improved insulation from road noise.

**Rear:** Lightweight torsion beam rear axle with one-piece, hollow cast trailing arms. Built-in anti-roll bar. Progressive-rate double conical mini-block springs and gas-pressure dampers.

### Vauxhall Assistance and warranties



See back cover for details of our comprehensive warranties.

### Weights and towing data kg

	Gross vehicle weight	Max. towing weights Trailer with brakes (without brakes)
1.6i 16v VVT Expression/Life (non-air conditioned)	2075	1000 (750)
1.6i 16v VVT Life/Exclusiv/Design	2090	1000 (750)
1.8i 16v VVT Life/Exclusiv/Design/Elite	2095	1200 (750)
1.7CDTi 16v (110PS) Life/Exclusiv/Design/Elite	2175	1300 (750)
1.7CDTi 16v (125PS) Life/Exclusiv/Design/Elite	2175	1400 (750)

**Gross vehicle weight** is the total permissible weight of the vehicle including passengers and their luggage. The **maximum roof rack loading** should not exceed 75kg. The **maximum towing weights** are based on the ability of the car, with two occupants of 75kg each, to restart on a 12% gradient, which is approximately 1 in 8.3, at sea level. At altitudes above 1500 metres, the engine output may drop with a corresponding reduction in towing capability. Any extra weight, such as luggage or additional passengers, should be deducted from the maximum towing weight. With a trailer fully loaded, **maximum noseweight** should not exceed 75kg. Always fit Vauxhall towing attachments and accessories available from your Vauxhall retailer.

## Exterior dimensions millimetres (inches)

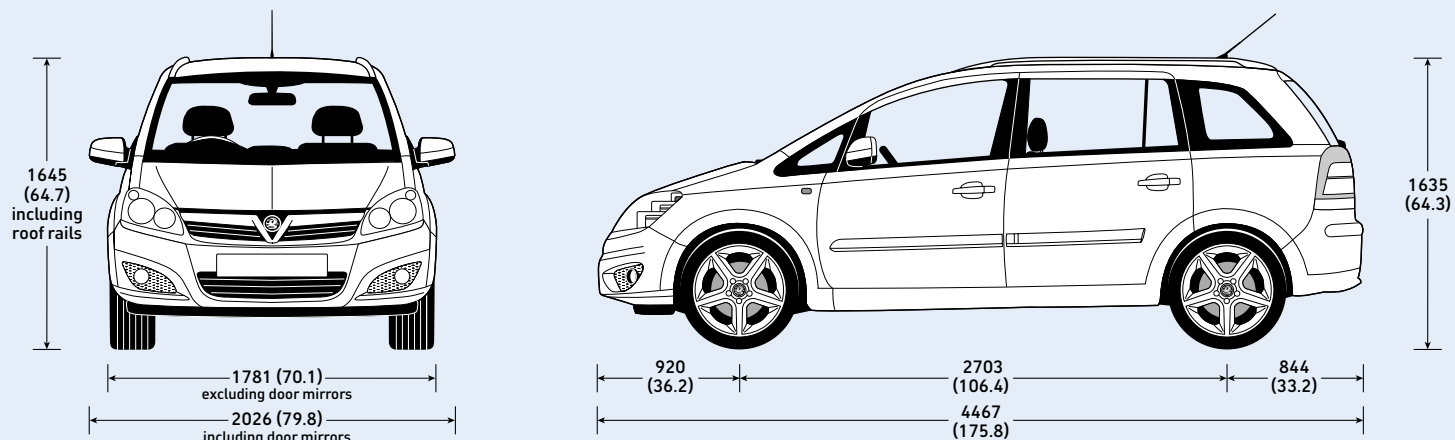

Technical data

## Luggage capacities (measured using the ECIE method)

	litres	cu.ft
Behind third-row, to glass line	140	4.9
Behind second-row, to glass line	645	22.8
Behind front seats, to glass line	1070	37.8
Behind front seats, to roof	1820	64.3

## Loadspace dimensions

	mm	inches
Maximum floor length – behind front seats, second-row seat back lowered	1809	71.2
Maximum floor length – behind front seats, second-row seat folded and stowed	1525	60.0
Maximum floor length – behind second-row seat	1088	42.8
Maximum floor length – behind third-row seat	405	15.9
Maximum floor width	1114	43.9
Width between wheel arches	1071	42.2
Tailgate aperture height	893	35.2
Tailgate aperture width	1136	44.7



**1820 litres**  
Maximum  
luggage capacity

# Trust Vauxhall

## Vauxhall Insurance

Available for new and used Vauxhalls, a Vauxhall Insurance policy offers a unique package designed specifically for Vauxhall drivers. For a highly competitive quotation, call **0844 463 2670**. Or just visit our website at [www.vauxhall.co.uk](http://www.vauxhall.co.uk)

## Fleet Customer Services

Our dedicated support services for fleet managers includes factory demonstrators, a three-day test drive programme and information on whole life costs, company car taxation and finance. For further information please call **0870 010 0651**.

## Buying your car

GMAC offers one of the most comprehensive and competitive ranges of financing plans in the UK. Contact your local Vauxhall retailer for details or call the GMAC customer service centre on **0845 712 3444**.

## Servicing and maintenance

The best way to maximise the performance and reliability of your Vauxhall is to have all routine servicing and maintenance carried out at one of around 400 Vauxhall retailers. To find your nearest retailer call **0845 600 1500**.

## In the event of an accident...

Vauxhall Accident Support helps keep you mobile following an accident. Benefits include scene-of-accident advice, message service, assistance with claims and vehicle recovery. For further details call **0800 010 304**.

## For more information...

For a brochure on any Vauxhall model (up to a maximum of three per caller) or location of your nearest Vauxhall retailer please call **0845 600 1500**.

Alternatively, details can be found on our website at [www.vauxhall.co.uk](http://www.vauxhall.co.uk)

Join us online:



Proud Sponsor of Home Nations Football



When you have finished with this brochure please recycle it

\*Vauxhall Lifetime Warranty covers lifetime ownership of first car owner, 100,000 mile limit, annual check required. The warranty excludes wear and tear and serviceable items and the vehicle must be serviced in accordance with the manufacturer's servicing schedule to continue the lifetime warranty. Terms and conditions apply. Offer available to all Vauxhall passenger cars (this offer does not apply to car-derived vans) from 1st August 2010.

Every effort has been made to ensure that the contents of this publication were accurate and up-to-date at the time of going to press (September 2011). Vauxhall vehicles are equipped with components manufactured by various General Motors operating units and outside suppliers. The Company reserves the right to alter specifications and withdraw products from sale without notice. Any such alterations will be notified to Vauxhall retailers at the earliest opportunity, please consult your local retailer for the latest information. The specifications detailed within this brochure are not necessarily applicable to alternative models such as Special Editions. Details of any such models will be contained in specific literature or found on the Vauxhall website. Please note that Vauxhall retailers are not the agents of General Motors UK Limited and are not authorised to bind the Company by any specific or implied undertaking or representation. It is advisable to ensure that your motor insurance policy provides adequate cover for additional fitted options and accessories. Please note accessories shown are for illustrative purposes only. As part of Vauxhall's policy of environmental care, this brochure is printed on paper manufactured using Elemental Chlorine Free pulps from specially farmed, sustainable timber resources. All rights reserved. No part of this publication may be reproduced in any form or by any means, without the prior written permission of General Motors UK Limited.

## Vauxhall Lifetime Warranty

We're so confident in Vauxhall quality and reliability that we are now able to offer a lifetime warranty. Available to the first owner of all new Vauxhall passenger cars, it's valid for the lifetime of the vehicle up to a maximum of 100,000 miles\*. In addition, our warranty also includes Vauxhall Assistance for 12 months from first registration and six years body panel anti-perforation warranty. Full details of Vauxhall's warranties including terms, conditions and exclusions can be obtained through any authorised Vauxhall retailer or go to: [www.vauxhall.co.uk/warranty](http://www.vauxhall.co.uk/warranty)

**LIFETIME**  
WARRANTY 100,000 MILE



**VAUXHALL**