



Astra

Owner's Manual

Contents

Emergency numbers		
For emergency service call the Vauxhall Incident Manager		0800 55 33 88 (Free Linkline)*
Vauxhall Assistance General Enquiries		0845 7565 565
You will need to provide:	Vehicle registration number	Model and colour of your Vauxhall
	Contact telephone number	Details of your precise location

* Calls may be chargeable from mobile phones

Introduction	2
Keys, doors and windows	6
Seats, restraints	30
Storage	53
Instruments and controls	65
Lighting	94
Infotainment system	103
Climate control	114
Driving and operating	122
Vehicle care	203
Service and maintenance	235
Technical data	240
Customer information	250
Index	256

Introduction

Fuel	Designation	<input type="text"/>		
Engine oil	Grade	<input type="text"/>		
	Viscosity	<input type="text"/>		
Tyre pressure	Tyre size		Front	Rear
	Summer tyres	<input type="text"/>	<input type="text"/>	<input type="text"/>
	Winter tyres	<input type="text"/>	<input type="text"/>	<input type="text"/>
Weights	Gross vehicle weight rating	<input type="text"/>		
	- Kerb weight, basic model	<input type="text"/>		
	= Loading	<input type="text"/>		

Vehicle specific data

Please enter your vehicle's data on the previous page to keep it easily accessible.

Please refer to the sections "Service and maintenance", "Technical data", the vehicle's identification plate and national registration documents.

Introduction

Your vehicle is a designed combination of advanced technology, safety, environmental friendliness and economy.

This Owner's Manual provides you with all the necessary information to enable you to drive your vehicle safely and efficiently.

Additionally, video tutorials for some vehicle functions can be viewed in the Info Display.

Some functions are only operational when ignition is switched on, when combustion engine is running or when electric engine is ready.

Make sure your passengers are aware of the possible risk of accident and injury which may result from improper use of the vehicle.

You must always comply with the specific laws and regulations of the country that you are in. These laws may differ from the information in this Owner's Manual.

Disregarding the description given in this manual may affect your warranty.

When this Owner's Manual refers to a workshop visit, we recommend your Vauxhall Authorised Repairer.

All Vauxhall Authorised Repairers provide first-class service at reasonable prices. Experienced mechanics trained by Vauxhall work according to specific Vauxhall instructions.

The customer literature pack should always be kept ready to hand in the vehicle.

Using this manual

- This manual describes all options and features available for this model. **Certain descriptions,**

including those for display and menu functions, may not apply to your vehicle due to model variant, country specifications, special equipment or accessories.

- The table of contents at the beginning of this manual and within each section shows where the information is located.
- The index will enable you to search for specific information.
- This Owner's Manual depicts left-hand drive vehicles. Operation is similar for right-hand drive vehicles.
- The Owner's Manual uses the engine identifier code. The corresponding sales designation and engineering code can be found in the section "Technical data".
- Directional data, e.g. left or right, or front or back, always relate to the direction of travel.

- Displays may not support your specific language.
- Display messages and interior labelling are written in **bold** letters.

Danger, Warnings and Cautions

Danger

Text marked ** Danger** provides information on risk of fatal injury. Disregarding this information may endanger life.

Warning

Text marked ** Warning** provides information on risk of accident or injury. Disregarding this information may lead to injury.

Caution

Text marked **Caution** provides information on possible damage to the vehicle. Disregarding this information may lead to vehicle damage.

Symbols

Page references are indicated with ⇨. ⇨ means "see page".

Page references and index entries refer to the indented headings given in the section table of content.

Thank you for choosing a Vauxhall.

We wish you many hours of pleasurable driving.

Your Vauxhall Team

Keys, doors and windows

Keys, locks	6
Keys	6
Radio remote control	7
Electronic key system	9
Central locking system	10
Automatic locking	15
Child locks	15
Doors	16
Load compartment	16
Vehicle security	20
Anti-theft locking system	20
Anti-theft alarm system	21
Immobiliser	23
Exterior mirrors	23
Convex shape	23
Electric adjustment	23
Folding mirrors	24
Heated mirrors	24
Interior mirrors	25
Manual anti-dazzle	25
Automatic anti-dazzle	25
Windows	26
Windscreen	26

Power windows	26
Heated rear window	27
Heated windscreen	28
Sun visors	28
Roof	28
Sunroof	28

Keys, locks

Keys

Key with foldaway key section

Caution

Do not attach heavy or bulky items to the ignition key.

⚠ Danger

Never remove the key from ignition switch during driving as this will cause steering wheel lock.



Press button to extend. To fold the key, first press the button.

Electronic Key with keyless Entry and Start



⚠ Warning

The electronic key can affect a pacemaker.

Keep the electronic key away from the breast.

Push the latch to extract the integral key.

Lock cylinders

Designed to free-wheel if they are forcefully rotated without the correct key or if the correct key is not fully inserted. To reset, insert the correct key only half way and turn cylinder until its slot is vertical, remove key then re-insert it. If the cylinder still free-wheels, insert the key only half way and turn the key through 180° and repeat operation.

Replacement keys

The key number is specified on a detachable tag.

The key number must be quoted when ordering replacement keys as it is a component of the immobiliser system.

Locks ⇨ 232.

Central locking ⇨ 10.

Starting the engine ⇨ 126.

Radio remote control ⇨ 7.



Electronic key ⇨ 9.

The code number of the adapter for the locking wheel nuts is specified on a card. It must be quoted when ordering a replacement adapter.

Wheel changing ⇨ 223.

Radio remote control



-  : unlocks the vehicle
-  : locks the vehicle
-  : long press unlocks and opens the tailgate

Enables operation of the following functions via the use of the remote control buttons:

- central locking system ⇨ 10
- anti-theft locking system ⇨ 20
- anti-theft alarm system ⇨ 21
- tailgate unlocking
- power windows ⇨ 26
- mirrors folding ⇨ 24
- vehicle locator lighting ⇨ 102

The remote control has a range of up to 50 m, but may also be much less due to external influences. The hazard warning flashers confirm operation.

Handle with care, protect from moisture and high temperatures and avoid unnecessary operation.

Replacing battery in radio remote control

Replace the battery as soon as the system no longer operates properly or the range is reduced.

In the event of a discharged battery,  illuminates and a warning message is displayed in the Driver Information Centre.

Driver Information Centre ⇨ 89.



Batteries do not belong in household waste. They must be disposed of at an appropriate recycling collection point.

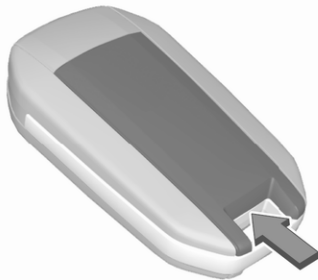

1. Remove the back cover from the remote control.
2. Extract the flat battery from its location.
3. Replace battery with a battery of the same type. Pay attention to the installation position.
4. Clip the back cover in place.

Fault

If the central locking system cannot be operated with the radio remote control, the cause may be one of the following:

- Fault in radio remote control.
- The battery voltage is too low.
- Overload of the central locking system by operating at frequent intervals, the power supply is interrupted for a short time.
- Interference from higher-power radio waves from other sources.

Manual unlocking ⇨ 10.

Electronic key system

⚠ Warning

The electronic key can affect a pacemaker.

Keep the electronic key away from the breast.



Enables a keyless operation of the following functions:

- central locking system ⇨ 10
- ignition switching on and starting the engine ⇨ 126

The electronic key simply needs to be on the driver's person.

For reasons of security, the electronic key may be equipped with a motion sensor. If so, starting of the vehicle is not possible when the electronic key has not been moved for a certain time. When trying to start the vehicle, a corresponding message appears in the Driver Information Centre. Move the electronic key and try to start the vehicle again.

Additionally, the electronic key includes the functionality of the radio remote control ⇨ 7.

Handle with care, protect from moisture and high temperatures and avoid unnecessary operation.

Replacing battery in electronic key

Replace the battery as soon as the system no longer operates properly or the range is reduced.

In the event of a discharged battery,  illuminates and a warning message is displayed in the Driver Information Centre.

Driver Information Centre ⇨ 89.



Batteries do not belong in household waste. They must be disposed of at an appropriate recycling collection point.



1. Remove the back cover.
2. Extract the flat battery from its location.
3. Replace battery with a battery of the same type. Insert the battery by pushing it against the contact

located in the corner and then pressing it down. Pay attention to the installation position.

4. Clip the back cover in place.

Fault

If the central locking cannot be operated or the engine cannot be started, the cause may be one of the following:

- Fault in electronic key.
- Electronic key is out of reception range.
- The battery voltage is too low.
- Overload of the central locking system by operating at frequent intervals, the power supply is interrupted for a short time.
- Interference from higher-power radio waves from other sources.
- Interference from electronic devices such as smartphones or laptops.

To rectify the cause of the fault, change the position of the electronic key.

Manual unlocking ⇨ 10.

Central locking system

Unlocks and locks doors, load compartment and fuel filler flap.

A pull on an interior door handle unlocks and opens the respective door.

When the driver's door only function is activated in the vehicle personalisation settings, only the driver's door unlocks when its interior handle is pulled. When the function is deactivated all doors will be unlocked.

Regardless of the vehicle personalisation setting, all doors will be unlocked when the interior handle of any other door than the driver's door is pulled.

Vehicle personalisation ⇨ 91.

Notice

In the event of an accident in which airbags or belt pretensioners are deployed, the vehicle is automatically unlocked.

Remote control operation

Unlocking





Press .

Notice

A short time after unlocking the vehicle with the remote control, the doors are locked automatically if no door has been opened.

Unlocking mode can be set in the vehicle personalisation menu in the Info Display. Following settings are selectable:

- All doors, load compartment and fuel filler flap will be unlocked by pressing  once.
- Only the driver's door and fuel filler flap will be unlocked by pressing  once. To additionally unlock all doors and the load compartment, press  twice.

Select the relevant setting in the Vehicle personalisation.

Vehicle personalisation ⇨ 91.

Locking

Close doors, load compartment and fuel filler flap.



Press .

If the vehicle is not closed properly, the central locking system will not work.



Operation of the central locking system is confirmed by the hazard warning flashers.

Load compartment



Press and hold  to unlock.

Unlocking settings for the load compartment can be set in the vehicle personalisation:

- Only the load compartment will be unlocked by pressing  once.
- All doors, load compartment and fuel filler flap will be unlocked by pressing  once.

Depending on the chosen setting in the vehicle personalisation, the load compartment can be locked:

- by simply closing the opened tailgate.
- by pressing  once on the remote control with the tailgate closed.

Select the relevant setting in the vehicle personalisation.

Vehicle personalisation ⇨ 91.

Unlocking the tailgate ⇨ 16.

Confirmation

Operation of the central locking system is confirmed by the hazard warning flashers and an audible chime.

Electronic key system operation

This system allows automatic vehicle locking and unlocking simply by detection of the electronic key. The electronic key must be outside the vehicle.

Notice

If the vehicle is not closed properly or the electronic key remains in the vehicle, locking will not be permitted. If the vehicle is equipped with an anti-theft alarm system, a warning chime sounds after a few seconds.

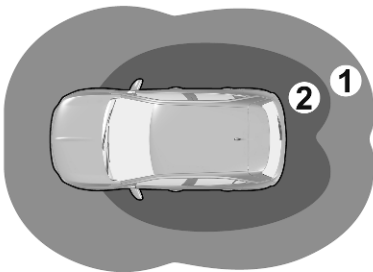

Notice

The electronic key may not operate if placed close to electronic devices such as mobile phones or laptop computers.



- Zone 1: automatic locking on leaving the vehicle
- Zone 2: automatic unlocking on approaching the vehicle



Notice



If the electronic key remains for more than 15 minutes in zone 1, automatic unlocking is deactivated. Unlock the vehicle by pressing  or  on the remote control or touch the sensor of the driver's door handle to unlock the vehicle. Automatic locking and unlocking is activated again.

Notice

A short time after automatic unlocking, the vehicle is relocked if no door has been opened.

Notice

If the ignition is switched off for more than nine days or the vehicle battery has no sufficient charging, the automatic function is disabled. Press  or  on the remote control or touch the sensor of the driver's door handle to unlock the vehicle.

In the event that the ignition is switched off for more than 21 days, the only way to unlock the vehicle is by pressing  or  on the remote control.

Unlocking / locking

Unlocking / locking mode can be set in the vehicle personalisation menu in the Info Display. Following settings are selectable:

- Only the driver's door and fuel filler flap will be unlocked / locked.
- All doors, load compartment and fuel filler flap will be unlocked / locked.
- Only the load compartment will be unlocked / locked.

Vehicle personalisation ↗ 91.

Load compartment ↗ 16.

Operation with buttons on the electronic key



The central locking system can also be operated with the buttons on the electronic key.

Press  or  to unlock.

Press  to lock.

Remote control operation ↗ 10.

Driver's door handle

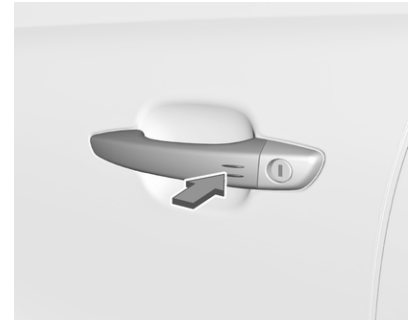

The central locking system can also be operated by touching the sensor of the driver's door handle.

Touch the sensor of the driver's door handle to unlock or to lock.

Confirmation

Operation of central locking system is confirmed by the hazard warning flashers.

Central locking button

Locks or unlocks all doors, the load compartment and fuel filler flap from inside the passenger compartment.



Press  to lock. The LED in the button illuminates.

Press  again to unlock. The LED in the button extinguishes.

Operation with the key in case of a central locking system fault

In case of a fault, e.g. vehicle battery or remote control / electronic key battery is discharged, the front door can be locked or unlocked with the mechanical key.

Manual unlocking

Extract or extend the key.

Keys ⇨ 6

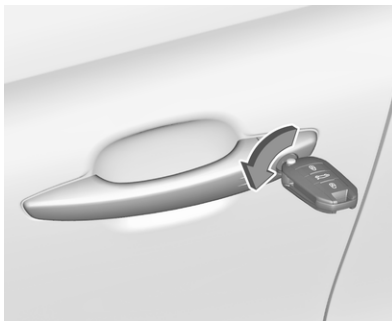

Manually unlock the left front door by inserting and turning the key in the lock cylinder.

The other doors can be opened by pulling the interior handle. The load compartment and fuel filler flap will possibly not be unlocked.

By switching on the ignition, the anti-theft locking system is deactivated.

Manual locking

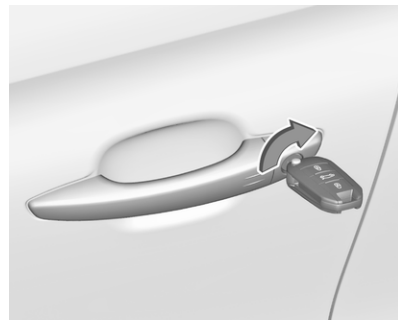

Manually lock the front doors by inserting and turning the key in the lock cylinder.

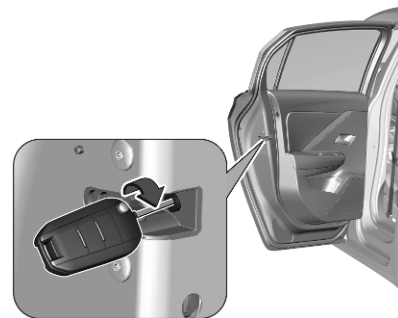

To lock the other doors, open the rear doors. Ensure that child lock is deactivated.

Insert key carefully and turn it to the inner side of the doors.

Then, remove key.

Close the doors.

The fuel filler flap and tailgate are possibly not locked.

Automatic locking

Automatic locking after driving off

This system allows automatic locking of the doors and tailgate as soon as the speed of the vehicle exceeds a certain speed.

If one of the doors or the tailgate is open, the automatic central locking does not take place. This is signalled by the sound of the locks rebounding, accompanied by illumination of  in the Driver Information Centre, an audible signal and the display of an alert message.



This function can be activated or deactivated at any time. With the ignition on, press  until an audible signal starts and a corresponding message is displayed.

The state of the system stays in memory when switching off the ignition.

Automatic relock after unlocking

This feature automatically relocks the vehicle a short time after unlocking with the remote control or electronic key, provided vehicle has not been opened.

Child locks

Warning

Use the child locks whenever children are occupying the rear seats.

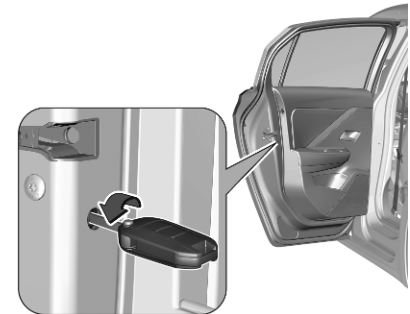

Turn the child lock in the rear door outwards to the horizontal position by using a key. The door cannot be opened from the inside.

To deactivate, turn the child lock in the opposite direction.

Doors

Load compartment

Tailgate

Opening

5-door Hatchback

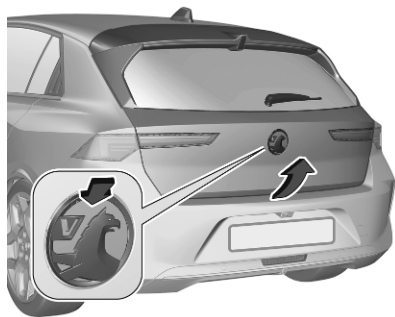

1. Press the emblem or press long  on the radio remote control.
2. Open the tailgate.

Sports Tourer

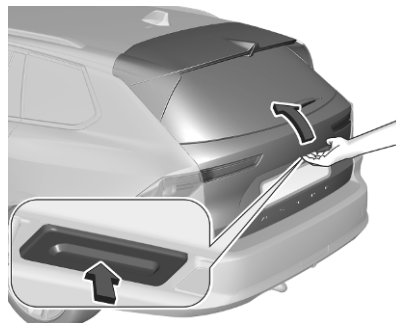

After unlocking, push the tailgate button under the tailgate moulding and open the tailgate manually.

Central locking system ⇨ 10.

Closing



Use the interior handle.

Central locking system ⇨ 10.

Power tailgate





Warning

Take care when operating the power tailgate. Risk of injury, particularly to children.

Keep a close watch on the movable tailgate when operating. Ensure that nothing becomes

trapped during operating and no one is standing within the moving area.

The power tailgate can be operated by:

- Pressing  on the electronic key. To prevent unintended opening of the tailgate,  must be pressed longer than during locking or unlocking.
- Hands-free operation with motion sensor below the rear bumper.
- The tailgate button under the exterior tailgate moulding and  in the open tailgate.
- Pressing  twice next to the steering wheel.

On vehicles with automatic transmission, the tailgate can only be operated when the vehicle is stationary and with selector lever in **P**.

The power tailgate can be adjusted in the Info Display.

Vehicle personalisation ⇨ 91.

Notice

Operating the power tailgate does not operate the central locking system. To open the tailgate with the button on the electronic key, or with the tailgate button or via hands-free operation, it is not necessary to unlock the vehicle. A precondition is that the electronic key is outside the vehicle, within a range of approx. 1 m of the tailgate.



Do not leave the electronic key in the load compartment.

Lock the vehicle after closing if it was unlocked previously.

Central locking system ⇨ 10.

Operation with the electronic key



Press and hold  to open or close the tailgate. To prevent unintended opening of the tailgate,  must be pressed longer than during locking or unlocking.

Hands-free operation with motion sensor below the rear bumper

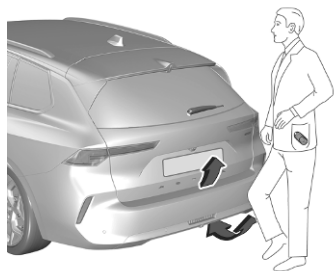

To open or close the tailgate, move the foot below the rear bumper back and forth in the area shown in the illustration. If equipped with parking assist, the area is recognisable below the sensor shown. Do not hold the foot longer or move too slow below the bumper. The electronic key must be outside the vehicle, within a range of approx. 1 m of the tailgate.

The turn lights will flash to indicate the power tailgate movement.

The hands-free operation can be adjusted in the Info Display.

Vehicle personalisation ⇨ 91.

⚠ Danger

Do not touch any vehicle parts below the vehicle during hands-free operation. There is a risk of injury from hot engine parts.

Operation with the tailgate button under the exterior tailgate moulding

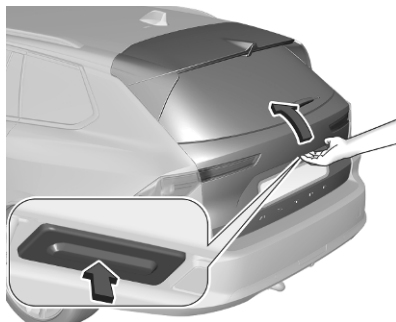

To open the tailgate, press the tailgate button under the tailgate moulding until the tailgate starts to move. If the vehicle is locked, the

electronic key must be outside the vehicle, within a range of approx. 1 m of the tailgate.



To close, press  in the open tailgate until the tailgate starts to move.

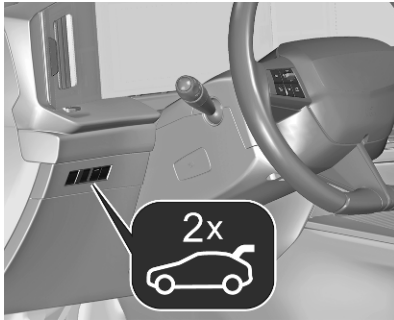

Operation with the button next to the steering wheel



Press  twice to open the tailgate.

Stop or change direction of movement

To stop movement of the tailgate immediately:

- press  once on the electronic key, or
- press the tailgate button under the exterior tailgate moulding, or
- press  on the open tailgate, or
- press  next to the steering wheel.

Pressing one of the switches again will reverse the direction of movement.

Memorising an opening height

To memorise a desired opening height, move the tailgate to the desired position and press one of the following buttons for more than three seconds:

-  in the open tailgate
- the button under the tailgate moulding

The adjusted memorisation will be confirmed by a chime. A new memorisation cancels the previous one.

Notice

Adjusting opening height should be programmed at ground level.

Safety function

If the power tailgate encounters an obstacle during opening or closing, the direction of movement will automatically be reversed slightly. Multiple obstacles in one power cycle

will deactivate the function. In this case, close or open the tailgate manually.

The power tailgate has pinch sensors on the side edges. If the sensors detect obstacles between tailgate and chassis, the tailgate will open, until it is activated again or closed manually.

The safety function is indicated by a warning chime.

Remove all obstacles before resuming normal power operation.

If the vehicle is equipped with factory-fitted towing equipment and a trailer is electrically connected, the power tailgate can only be opened with the tailgate button or closed with  in the open tailgate. Ensure that there are no obstacles in the moving area.

Overload

If the power tailgate is repeatedly operated at short intervals, the function is disabled for some time. Move tailgate manually into end position to reset the system.

General hints for operating tailgate

Danger

Do not drive with the tailgate open or ajar, e.g. when transporting bulky objects, since toxic exhaust gases, which cannot be seen or smelled, could enter the vehicle. This can cause unconsciousness and even death.

Caution

Before opening the tailgate, check overhead obstructions, e.g. a garage door, to avoid damage to the tailgate. Always check the moving area above and behind the tailgate.

Caution

Do not install any carrier onto the tailgate.

Notice

At low outside temperatures the tailgate may not open fully by itself. In this case lift the tailgate manually to its normal end position.

Vehicle security

Anti-theft locking system

Warning

Do not use the system if there are people in the vehicle! The doors cannot be unlocked from the inside.

The system deadlocks all the doors. All doors must be closed and the electronic key must be outside the vehicle otherwise the system cannot be activated.

Unlocking the vehicle disables the mechanical anti-theft locking system. This is not possible with the central locking button.

Activating



Press  on the radio remote control or touch the sensor of the driver's door handle twice within five seconds.

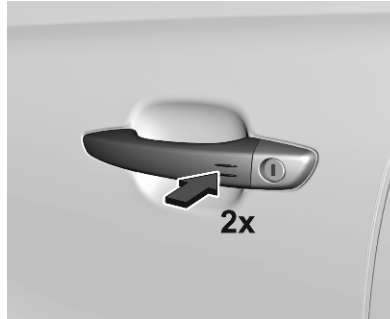

Anti-theft alarm system

The anti-theft alarm system is combined with the central locking system.

It monitors:

- doors, tailgate, bonnet
- passenger compartment including adjoining load compartment
- vehicle inclination, e.g. if it is raised
- ignition

If the sunroof remains open, the passenger compartment is not monitored.

During temperature preconditioning, the passenger compartment and the vehicle inclination are not monitored.

Activation

All doors, the load compartment, the engine compartment and the sunroof must be closed.

The electronic key must be outside the vehicle.

The system is self-activated 45 seconds after locking the vehicle.

If a door or the tailgate is not properly closed, the vehicle is not locked. However, the anti-theft alarm is self-activated after 45 seconds.

Notice

The automatic vehicle locking function does not activate the anti-theft alarm system.

To activate the anti-theft alarm system, lock the vehicle by using the radio remote control or by touching the sensor on the driver's door handle.



Central locking system ⇨ 10.

Notice

Changes to the vehicle interior such as the use of seat covers and open windows, could impair the function of passenger compartment monitoring.

Activation without monitoring of passenger compartment and vehicle inclination

Switch off the monitoring of passenger compartment and vehicle inclination when animals are being left in the vehicle, because of high volume ultrasonic signals or movements triggering the alarm. Also, switch off when the vehicle is on a ferry or train.

1. Close tailgate, bonnet, windows.
2. Switch off ignition and press  within ten seconds until the LED in the button  illuminates.

3. Leave the vehicle and close the doors.
4. Activate the anti-theft alarm system.

Indication

LED in the  button flashes if the anti-theft alarm system is activated. The hazard warning lights illuminate for a few seconds.

Deactivation

Unlocking the vehicle deactivates the anti-theft alarm system.

The system is not deactivated by unlocking the front door with the key or with the central locking button in the passenger compartment.

Alarm

When triggered, the alarm siren sounds and the hazard warning lights flash simultaneously. The number and duration of alarm signals are stipulated by legislation.

The anti-theft alarm can be deactivated by pressing  or switching on the ignition.

A triggered alarm, which has not been interrupted by the driver, will be indicated by the LED in the button . The LED will flash quickly the next time the vehicle is unlocked.

If the vehicle battery has been reconnected (e.g. after maintenance work), wait for ten minutes to restart the engine.

Fault

If the LED in the button  illuminates permanently when switching on the ignition, seek the assistance of a workshop.

Locking the vehicle without activation of the anti-theft alarm

Lock the vehicle by locking the front door with the key.

Immobiliser

The system is part of the ignition switch and checks whether the vehicle is allowed to be started with the key being used.

The immobiliser is activated automatically.

Notice

Radio Frequency Identification (RFID) tags may cause interference with the key. Do not have it placed near the key when starting the vehicle.

Notice

The immobiliser does not lock the doors. Always lock the vehicle after leaving it  10.

Switch on the anti-theft alarm system  21.

Emergency operation of electronic key  124.

Exterior mirrors

Convex shape

The shape of the mirror makes objects appear smaller, which will affect the ability to estimate distances.

Side blind spot alert  166.

Electric adjustment

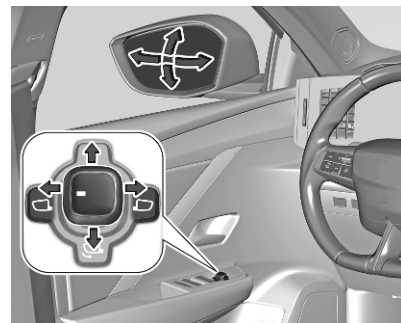

Select the relevant exterior mirror by turning the marking on the knob to it. Then swivel the control to adjust the mirror.

Folding mirrors





For pedestrian safety, the exterior mirrors will swing out of their normal mounting position if they are struck with sufficient force. Reposition the mirror by applying slight pressure to the mirror housing.

Manual electric folding



Turn marking on knob to .

Push knob towards . Both exterior mirrors are folded.

Push knob towards  again. Both exterior mirrors return to their original position.

If an electrically folded mirror is manually unfolded, only the other mirror will be unfolded electrically.

Automatic electric folding

When the vehicle is unlocked, the mirrors swing to their normal mounting position. When the vehicle is locked, the mirrors are folded down.

Heated mirrors



Operated by pressing .

Heating is switched off automatically after a short time.

Heated rear window  27.

Interior mirrors

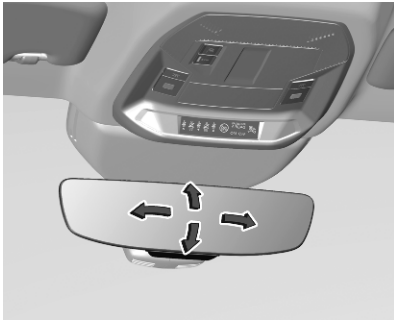

To adjust the mirror, move the mirror housing in the desired direction.

Manual anti-dazzle

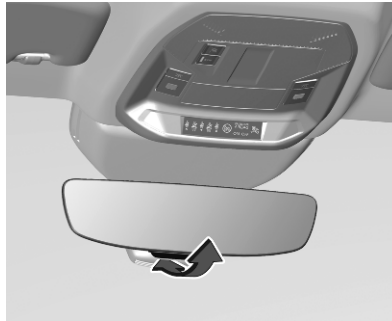

To reduce dazzle, adjust the lever on the underside of the mirror housing.

Automatic anti-dazzle



Dazzle from following vehicles is automatically reduced, when driving in the dark.

Windows

Windscreen

Windscreen stickers

Do not attach stickers such as toll road stickers or similar on the windscreen in the area of the interior mirror. Otherwise the detection zone of the sensor and the view area of the camera in the mirror housing could be restricted.

Windscreen replacement

Caution

If the vehicle has a front-looking camera sensor for the driver assistance systems, it is very important that any windscreen replacement is performed accurately according to Vauxhall specifications. Otherwise, these systems may not work properly and there is a risk of unexpected behaviour and / or messages from these systems.

Power windows

⚠ Warning

Take care when operating the power windows. Risk of injury, particularly to children.

If there are children on the rear seats, switch on the child safety system for the power windows.

Keep a close watch on the windows when closing them. Ensure that nothing becomes trapped in them as they move.

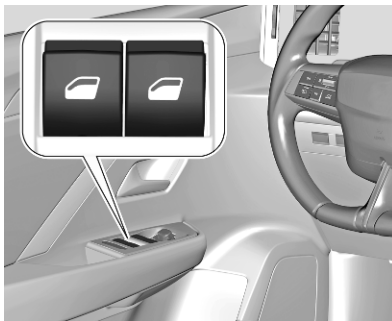

Operate the switch for the respective window by pushing to open or pulling to close.

Pushing or pulling gently to the first detent: window moves up or down as long as the switch is operated.



Pushing or pulling firmly to the second detent then releasing: window moves up or down automatically with safety function enabled. To stop movement, operate the switch once more in the same direction.

Safety function

If the window glass encounters resistance of the window during automatic closing, it is immediately stopped and opened again.

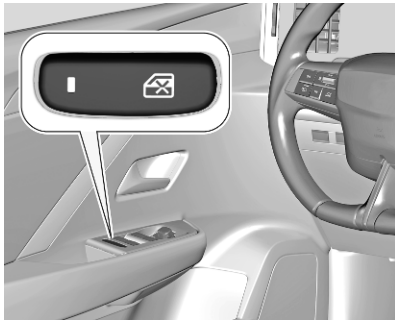
Child safety system for rear windows



Press  to deactivate rear door power windows; the LED illuminates. To activate, press  again.

Closing windows from outside

The windows can be closed remotely from outside the vehicle.

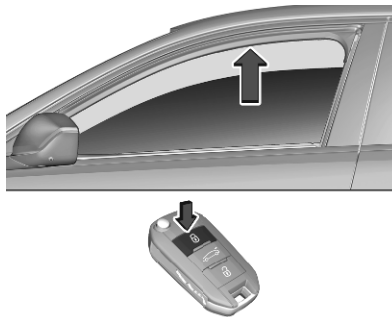

Press and hold  to close windows. If the windows are fully closed, the hazard warning lights will flash twice.

Overload

If the windows are repeatedly operated within short intervals, the window operation is disabled for some time.

Initialising the power windows

Activate the window electronics as follows:

1. Close doors.
2. Switch on ignition.

3. Open the window completely by using the switch.
4. Pull the switch repeatedly until the window is completely closed and keep pushing for additional 1 second. Note that the window closes only a few centimetres after each pull of the switch.
5. Repeat for each window.

Heated rear window

Operated by pressing  together with heated exterior mirrors.

Heating is switched off automatically after a short time.



Heated mirrors ⇨ 24.

Heated windscreen



Operated by touching . LED illuminates when heated windscreen is activated.

Heating works with the engine running and is switched off automatically after a short time.

Touch  once more during the same ignition cycle allows the heating to operate for another short time.

Sun visors

The sun visors can be folded down or swivelled to the side to prevent dazzling.

If the sun visors have integral mirrors, the mirror covers should be closed when driving.

A ticket holder is located on the backside of the sun visor.

Roof

Sunroof

Warning

Take care when operating the sunroof. Risk of injury, particularly to children.

Keep a close watch on the movable parts when operating them. Ensure that nothing becomes trapped in them as they move.

Switch on ignition to operate the sunroof.



Open or close

Press and hold : sunroof is opened or closed as long as the switch is operated.

Press  firmly then release: the sunroof is opened or closed automatically. During closing the safety function is enabled. To stop movement, operate the switch once more.

Sunblind

The sunblind is manually operated. Close or open the sunblind by sliding. When the sunroof is open, the sunblind is always open.

General hints

Safety function

If the sunroof encounters resistance during automatic closing, it is immediately stopped and opened again.

Override safety function

In the event of closing difficulties, e.g. due to frost, press and hold . The sunroof closes with safety function disabled. To stop movement, release the switch.

Closing sunroof from outside

The sunroof can be closed remotely from outside the vehicle.



Press and hold  for more than two seconds to close the sunroof. Release the button to stop the movement.

Initialising after a power failure

After a power failure, it may only be possible to operate the sunroof to a limited extent. Have the system initialised by your workshop.

Seats, restraints

Head restraints	30
Front seats	31
Seat position	31
Manual seat adjustment	32
Power seat adjustment	34
Armrest	36
Heating	36
Ventilating	36
Massage	37
Rear seats	37
Heating	37
Seat belts	38
Three-point seat belt	39
Airbag system	40
Front airbag system	43
Side airbag system	44
Curtain airbag system	45
Airbag deactivation	45
Child restraints	46
Child restraint systems	46
Child restraint installation locations	50

Head restraints

Position

⚠ Warning

Only drive with the head restraint set to the proper position.

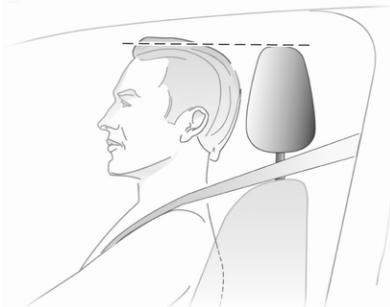

The upper edge of the head restraint should be at upper head level. If this is not possible for extremely tall people, set to highest position, and set to lowest position for small people.

Adjustment

Head restraints on front seats

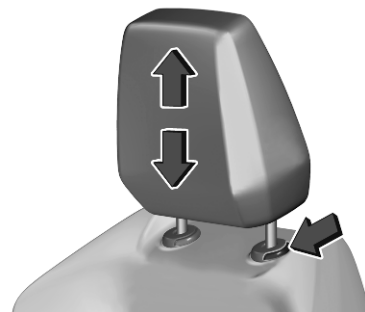

Pull the head restraint upwards or press the catch to release and push the head restraint downwards.

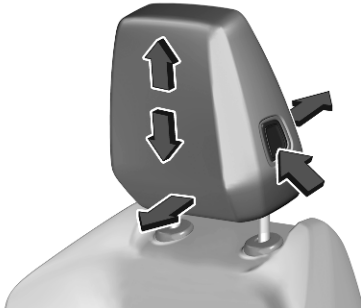

Press the catch and move the head restraint upwards, downwards, forwards or backwards until the desired position is adjusted.

Head restraints on rear seats

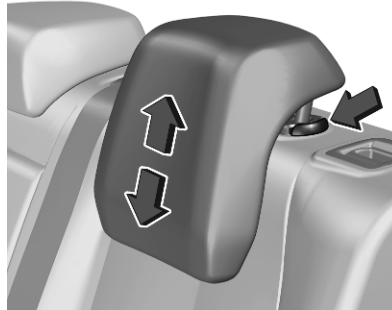

Pull the head restraint upwards or press the catch to release and push the head restraint downwards.

Removal

Press catch, pull the respective head restraint upwards and remove.

Front seats

Seat position

⚠ Warning

Only drive with the seat correctly adjusted.

⚠ Warning

Never adjust seats while driving as they could move uncontrollably.

⚠ Danger

Do not sit closer than 25 cm to the steering wheel, to permit safe airbag deployment.

⚠ Warning

Never store any objects under the seats.

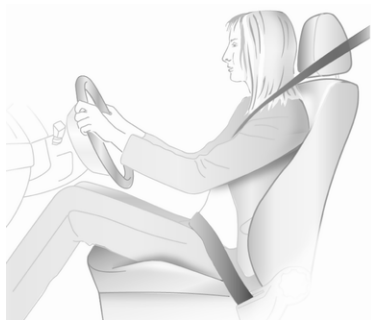

- Sit with buttocks as far back against the backrest as possible. Adjust the distance between the seat and the pedals so that legs are slightly angled when pressing the pedals. Slide the front passenger seat as far back as possible.
- Set seat height high enough to have a clear field of vision on all sides and of all display instruments. There should be at least one hand of clearance between head and the roof frame. Your thighs should rest lightly on the seat without pressing into it.

- Adjust the head restraint so that its upper edge is at upper head level.
- Sit with shoulders as far back against the backrest as possible. Set the backrest rake so that it is possible to easily reach the steering wheel with arms slightly bent. Maintain contact between shoulders and the backrest when turning the steering wheel. Do not angle the backrest too far back. We recommend a maximum rake of approx. 25°.
- Adjust seat and steering wheel in a way that the wrist rests on top of the steering wheel while the arm is fully extended and shoulders are on the backrest.
- Adjust the lumbar support so that it supports the natural shape of the spine.

Head restraint adjustment ⇨ 30.

Steering wheel adjustment ⇨ 68.

Manual seat adjustment

Drive only with engaged seats and backrests.

Longitudinal adjustment



Pull handle, slide seat, release handle. Try to move the seat back and forth to ensure that the seat is locked in place.

Backrest inclination



Turn handwheel. Do not lean on backrest when adjusting.

Seat height

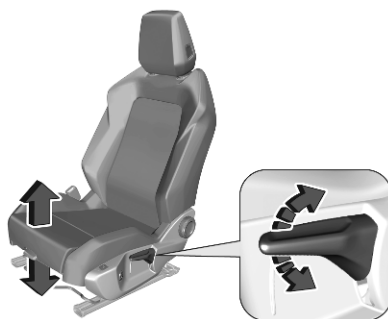

Lever pumping motion
up : seat higher
down : seat lower

Lumbar support

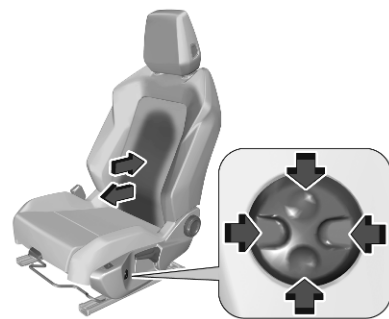

Adjust lumbar support using the four-way switch to suit personal requirements.

Press and hold the front or rear of the switch to increase or decrease the lumbar support.

Press and hold the top or bottom of the switch to raise or lower the lumbar support.

Thigh support

Pull the lever and slide the thigh support.

Power seat adjustment**⚠ Warning**

Care must be taken when operating the power seats. There is a risk of injury, particularly for children. Objects could become trapped.

Keep a close watch on the seats when adjusting them. Vehicle passengers should be informed accordingly.

Longitudinal adjustment

Move switch forwards / backwards.

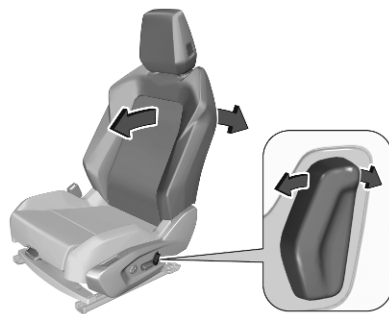
Backrest inclination

Tilt switch forwards / backwards.

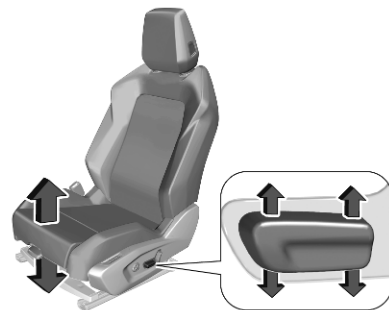
Seat height and angle

Tilt the rear of the switch upwards / downwards to adjust the height.

Tilt the front of the switch upwards / downwards to adjust the angle.

Lumbar support

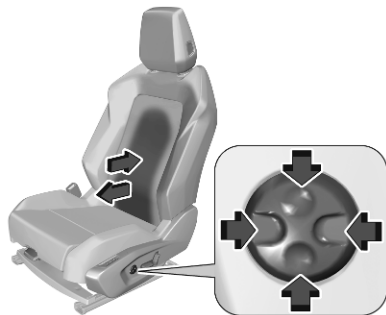

Adjust lumbar support using the four-way switch to suit personal requirements.

Press and hold the front or rear of the switch to increase or decrease the lumbar support.

Press and hold the top or bottom of the switch to raise or lower the lumbar support.

Thigh support

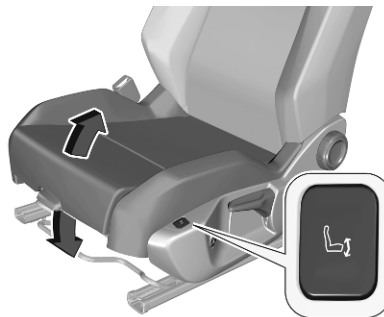

Press and hold the front or rear of the button to raise or lower the thigh support.

Memory function for power seat adjustment and exterior mirrors

Two different driver's seat and exterior mirror settings can be stored.

Vehicle personalisation ⇨ 91.

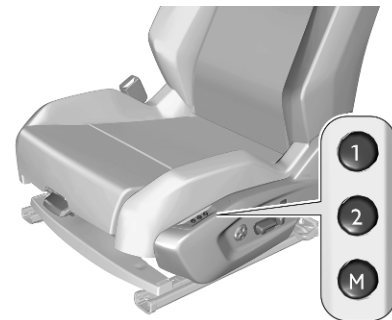

Storing memory position

- Adjust driver's seat and then adjust exterior mirrors to desired positions.
- Press **M** and then press **1** or **2** within four seconds.

A chime sounds to confirm the storing.

Recall of memory positions

Press **1** or **2** to recall the corresponding position.

A chime sounds when recalling has been finished.

Recalling can be interrupted by pressing **M**, **1** or **2** or by using one of the seat adjustment controls.

A stored position cannot be recalled while driving. The recalling of stored positions is deactivated 45 seconds after the ignition has been switched off.

Armrest

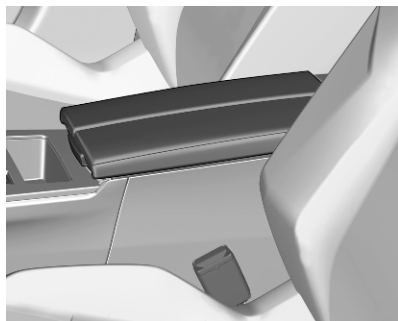

Storage compartment ↗ 55.

Heating



Adjust the heating to the desired intensity by pressing  for the respective seat one or more times. The control indicator in the button indicates the selected intensity.

Prolonged use of the highest intensity for people with sensitive skin is not recommended.

The settings are memorised when the ignition is switched off.

The heating can also be adjusted in the seat options app in the Info Display. Touch  on the screen to activate or deactivate seat heating.

Adjust the heating to the desired intensity by touching the control indicator on the screen. The driver seat and the passenger seat can be adjusted independently.

Ventilating



Adjust the ventilation to the desired intensity by pressing  for the respective seat one or more times. The control indicator in the button indicates the selected intensity.

The settings are memorised when the ignition is switched off.

The ventilation can also be adjusted in the seat options app in the Info Display. Touch  to activate or deactivate the ventilation.

Adjust the ventilation to the desired intensity by touching the control indicator on the screen. The driver seat and the passenger seat can be adjusted independently.

Massage



A massage can be activated or deactivated via the seat options app in the Info Display.

Touch  to activate or deactivate a massage.

Different types of massages can be selected by swiping on the screen. The massages for the driver seat and the passenger seat can be selected independently.

After selecting the type of massage, the intensity can be selected:

- 1 : low
- 2 : normal
- 3 : high

The massage function is activated for a period of one hour. During this time, the massage is performed in sequences of six minutes of massage followed by three minutes at rest.

The settings are memorised when the ignition is switched off.

Rear seats

Heating

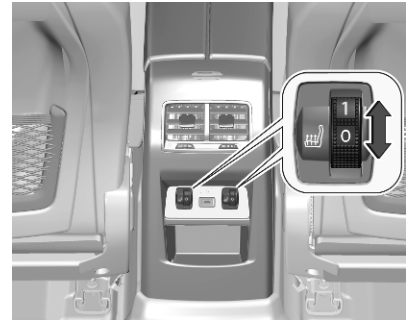

The heating can be adjusted by turning the thumb wheels in the centre console.

Prolonged use of the highest intensity for people with sensitive skin is not recommended.

The settings are memorised when the ignition is switched off.

Seat belts



The seat belts are locked during heavy acceleration or deceleration of the vehicle, holding the occupants in the seat position. Therefore the risk of injury is considerably reduced.

Seat belts are designed to be used by only one person at a time.

Child restraint system ⇨ 46.

Periodically check all parts of the belt system for damage, soiling and proper functionality.

Have damaged components replaced. After an accident, have the seat belts and triggered belt pretensioners replaced by a workshop.

Notice

Make sure that the belts are not damaged by shoes or sharp-edged objects or are trapped. Prevent dirt from getting into the belt retractors.

Notice

Use the belt buckle intended for the respective seat belt when fastening in order to ensure proper functionality.

Seat belt reminder

Each seat is equipped with a seat belt reminder, indicated by a control indicator  for the respective seat in the roof console ⇨ 79.

Belt force limiters

Stress on the body is reduced by the gradual release of the belt during a collision.

Belt pretensioners

In the event of a head-on, rear-end or side-on collision of a certain severity, the front seat belts and the outer rear seat belts are tightened.

Warning

Incorrect handling (e.g. removal or fitting of belts) can trigger the belt pretensioners.

Deployment of the belt pretensioners is indicated by continuous illumination of control indicator  ⇨ 80.

Triggered belt pretensioners must be replaced by a workshop. Belt pretensioners can only be triggered once.

Notice

Do not affix or install accessories or other objects that may interfere with the operation of the belt pretensioners. Do not make any modifications to belt pretensioner components as this will invalidate the operating permit of your vehicle.

Three-point seat belt

Fasten

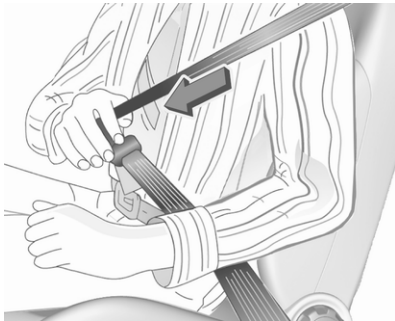

Withdraw the belt from the retractor, guide it untwisted across the body and insert the latch plate into the buckle. Make sure the belt fits tightly to the body while driving.

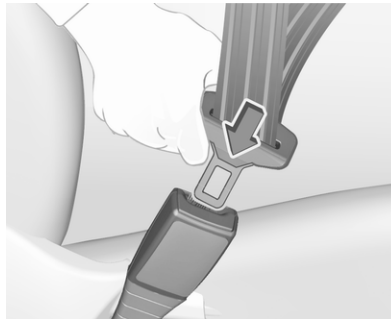

Loose or bulky clothing prevents the belt from fitting snugly. Do not place objects such as handbags or mobile phones between the belt and your body.

⚠ Warning

The belt must not rest against hard or fragile objects in the pockets of your clothing.

Seat belt reminder   79.

Unfasten

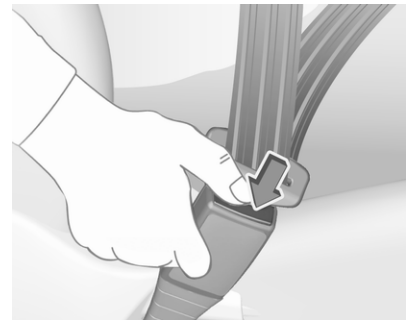

To release belt, press red button on belt buckle.

Using seat belts while pregnant

**⚠ Warning**

The lap belt must be positioned as low as possible across the pelvis to prevent pressure on the abdomen.

Airbag system

The airbag system consists of a number of individual systems.

When triggered, the airbags inflate within milliseconds. They also deflate so quickly that it is often unnoticeable during the collision.

⚠ Warning

The airbag system deploys in an explosive manner, repairs must be performed by skilled personnel only.

⚠ Warning

Adding accessories that change the vehicle's frame, bumper system, height, front end or side sheet metal, may keep the airbag system from working properly. The operation of the airbag system can also be affected by changing any parts of the front seats, seat belts, airbag sensing and diagnostic module, steering wheel,

instrument panel, inner door seals including the speakers, any of the airbag modules, ceiling or pillar trim, front sensors, side impact sensors or airbag wiring.

⚠ Warning

Keep the area in which the airbag inflates clear of obstructions.

Notice

In the event of an accident with airbag deployment, the engine is switched off automatically if the vehicle comes to a standstill within a certain time.

Notice

The airbag systems and belt pretensioner control electronics are located in the centre console area. Do not put any magnetic objects in this area.

Do not affix any objects onto the airbag covers and do not cover them with other materials. Have damaged covers replaced by a workshop.

Each airbag is triggered only once. Have deployed airbags replaced by a workshop. Furthermore, it may be necessary to have the steering wheel, the instrument panel, parts of the panelling, the door seals, handles and the seats replaced.

Do not make any modifications to the airbag system as this will invalidate the vehicle operating permit.

Control indicator  for airbag systems ⇨ 80.

Child restraint systems on front passenger seat with airbag systems



EN: NEVER use a rearward-facing child restraint on a seat protected by an ACTIVE AIRBAG in front of it; DEATH or SERIOUS INJURY to the CHILD can occur.

DE: Nach hinten gerichtete Kindersitze NIEMALS auf einem Sitz verwenden, der durch einen davor befindlichen AKTIVEN AIRBAG geschützt ist, da dies den TOD oder SCHWERE VERLETZUNGEN DES KINDES zur Folge haben kann.

FR: NE JAMAIS utiliser un siège d'enfant orienté vers l'arrière sur un siège protégé par un COUSSIN GONFLABLE ACTIF placé devant lui, sous peine d'infliger des BLESSURES GRAVES, voire MORTELLES à l'ENFANT.

ES: NUNCA utilice un sistema de retención infantil orientado hacia atrás en un asiento protegido por un AIRBAG FRONTAL ACTIVO. Peligro de MUERTE o LESIONES GRAVES para el NIÑO.

RU: ЗАПРЕЩАЕТСЯ устанавливать детское удерживающее устройство лицом назад на сиденье автомобиля,

оборудованном фронтальной подушкой безопасности, если ПОДУШКА НЕ ОТКЛЮЧЕНА! Это может привести к СМЕРТИ или СЕРЬЕЗНЫМ ТРАВМАМ РЕБЕНКА.

NL: Gebruik NOOIT een achterwaarts gericht kinderzitje op een stoel met een ACTIEVE AIRBAG ervoor, om DODELIJK of ERNSTIG LETSEL van het KIND te voorkomen.

DA: Brug ALDRIG en bagudvendt autostol på et forsæde med AKTIV AIRBAG, BARNET kan komme i LIVSFARE eller komme ALVORLIGT TIL SKADE.

SV: Använd ALDRIG en bakåtvänd barnstol på ett säte som skyddas med en framförvarande AKTIV AIRBAG. DÖDSFALL eller ALLVARLIGA SKADOR kan drabba BARNET.

FI: ÄLÄ KOSKAAN sijoita taaksepäin suunnattua lasten turvaistuinta istuimelle, jonka edessä on AKTIIVINEN TURVATYYNY, LAPSI VOI KUOLLA tai VAMMAUTUA VAKAVASTI.

NO: Bakovervendt barnesikringsutstyr må ALDRI brukes på et sete med AKTIV KOLLISJONSPUTE foran, da det kan føre til at BARNET utsettes for LIVSFARE og fare for ALVORLIGE SKADER.

PT: NUNCA use um sistema de retenção para crianças voltado para trás num banco protegido com um AIRBAG ACTIVO na frente do mesmo, poderá ocorrer a PERDA DE VIDA ou FERIMENTOS GRAVES na CRIANÇA.

IT: Non usare mai un sistema di sicurezza per bambini rivolto all'indietro su un sedile protetto da AIRBAG ATTIVO di fronte ad esso: pericolo di MORTE o LESIONI GRAVI per il BAMBINO!

EL: ΠΟΤΕ μη χρησιμοποιείτε παιδικό κάθισμα ασφαλείας με φορά προς τα πίσω σε κάθισμα που προστατεύεται από μετωπικό ΕΝΕΡΓΟ ΑΕΡΟΣΑΚΟ, διότι το παιδί μπορεί να υποστεί ΘΑΝΑΣΙΜΟ ή ΣΟΒΑΡΟ ΤΡΑΥΜΑΤΙΣΜΟ.

PL: NIE WOLNO montować fotelika dziecięcego zwróconego tyłem do kierunku jazdy na fotelu, przed którym znajduje się WŁĄCZONA PODUSZKA POWIETRZNA. Niezastosowanie się do tego zalecenia może być przyczyną ŚMIERCI lub POWAŻNYCH OBRAŻEŃ u DZIECKA.

TR: Arkaya bakan bir çocuk emniyet sistemini KESİNLİKLE önünde bir AKTİF HAVA YASTIĞI ile korunmakta olan bir koltukta kullanmayınız. ÇOCUK ÖLEBİLİR veya AĞIR ŞEKİLDE YARALANABİLİR.

UK: НИКОЛИ не використовуйте систему безпеки для дітей, що встановлюється обличчям назад, на сидінні з УВІМКНЕНОЮ ПОДУШКОЮ БЕЗПЕКИ, інакше це може призвести до СМЕРТІ чи СЕРІОЗНОГО ТРАВМУВАННЯ ДИТИНИ.

HU: SOHA ne használjon hátrafelé néző biztonsági gyerekülést előlről AKTÍV LÉGZSÁKKAL védett ülésen, mert a GYERMEK HALÁLÁT vagy KOMOLY SÉRÜLÉSÉT okozhatja.

HR: NIKADA nemojte koristiti sustav zadržavanja za djecu okrenut prema natrag na sjedalu s AKTIVNIM ZRAČNIM JASTUKOM ispred njega, to bi moglo dovesti do SMRTI ili OZBILJNJIH OZLJEDA za DIJETE.

SL: NIKOLI ne nameščajte otroškega varnostnega sedeža, obrnjenega v nasprotni smeri vožnje, na sedež z AKTIVNO ČELNO ZRAČNO BLAZINO, saj pri tem obstaja nevarnost RESNIH ali SMRTNIH POŠKODB za OTROKA.

SR: NIKADA ne koristiti bezbednosni sistem za decu u kome su deca okrenuta unazad na sedištu sa AKTIVNIM VAZDUŠNIM JASTUKOM ispred sedišta zato što DETE može da NASTRADA ili da se TEŠKO POVREDI.

MK: НИКОГАШ не користете детско седиште свртено наназад на седиште заштитено со АКТИВНО ВОЗДУШНО ПЕРНИЧЕ пред него, зато што детето може ДА ЗАГИНЕ или да биде ТЕШКО ПОВРЕДЕНО.

BG: НИКОГА не използвайте детска седалка, гледаща назад, върху седалка, която е защитена

чрез АКТИВНА ВЪЗДУШНА ВЪЗГЛАВНИЦА пред нея - може да се стигне до СМЪРТ или СЕРИОЗНО НАРАНЯВАНЕ на ДЕТЕТО.

RO: Nu utilizați NICIODATĂ un scaun pentru copil îndreptat spre partea din spate a mașinii pe un scaun protejat de un AIRBAG ACTIV în fața sa; acest lucru poate duce la DECESUL sau VĂTĂMAREA GRAVĂ a COPILULUI.

CS: NIKDY nepoužívejte dětský zádržný systém instalovaný proti směru jízdy na sedadle, které je chráněno před sedadlem AKTIVNÍM AIRBAGEM. Mohlo by dojít k VÁŽNÉMU PORANĚNÍ nebo ÚMRTÍ DÍTĚTE.

SK: NIKDY nepoužívajte detskú sedačku otočenú vzad na sedadle chránenom AKTÍVNÝM AIRBAGOM, pretože môže dôjsť k SMRTI alebo VÁŽNYM ZRANENIAM DIEŤAŤA.

LT: JOKIU BŪDU nemontuokite atgal atgręžtos vaiko tvirtinimo sistemas sėdynėje, prieš kurią įrengta AKTYVI ORO PAGALVĖ, nes VAIKAS GALI ŽŪTI arba RIMTAI SUSIŽALOTI.

LV: NEKĀDĀ GADĪJUMĀ neizmantojiet uz aizmuguri vērstu bērnu sēdekļiņi sēdvietā, kas tiek aizsargāta ar tās priekšā uzstādītu AKTĪVU DROŠĪBAS SPILVENU, jo pretējā gadījumā BĒRNS var gūt SMAGAS TRAUMAS vai IET BOJĀ.

ET: ÄRGE kasutage tahapoole suunatud lapseturvaistet istmel, mille ees on AKTIIVSE TURVAPADJAGA kaitstud iste, sest see võib põhjustada LAPSE SURMA või TÕSISE VIGASTUSE.

MT: QATT tuża trażżin għat-ffal li jħares lejn in-naħa ta' wara fuq sit protett b' AIRBAG ATTIV quddiemu; dan jista' jikkawża l-MEWT jew ĠRIEĦI SERJI lit-TFAL.

GA: Ná húsáid srian sábháilteachta linbh cúil RIAMH ar shuíochán a bhfuil mála aeir ag feidhmiú os a chomhair. Tá baol BÁIS nó GORTÚ DONA don PHÁISTE ag baint leis.

Additionally, for safety reasons a forward-facing child restraint system must only be used subject to the instructions and restrictions in the table ⇨ 50.

The airbag label is located on both sides of the front passenger sun visor. Airbag deactivation ⇨ 45.

Front airbag system

The front airbag system consists of one airbag in the steering wheel and one in the instrument panel on the front passenger side. These can be identified by the word **AIRBAG**.

The front airbag system is triggered in the event of a front-end impact of a certain severity. The ignition must be switched on.

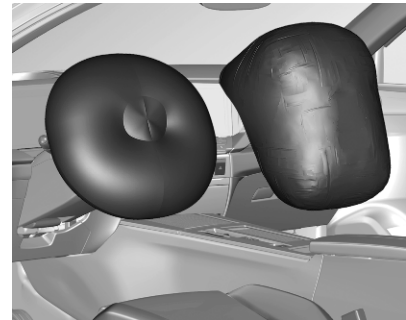

The inflated airbags cushion the impact, thereby reducing the risk of injury to the upper body and head of the front seat occupants considerably.

⚠ Warning

Optimum protection is only provided when the seat is in the proper position.

Seat position ⇨ 31.

Fasten the seat belt correctly and engage securely. Only then is the airbag able to protect.

Side airbag system

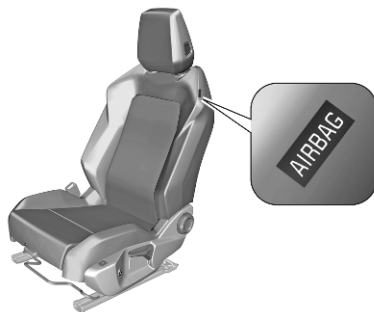

The side airbag system consists of an airbag in each front seat backrest and in the rear outer seat backrests. This can be identified by the word **AIRBAG**.

The side airbag system is triggered in the event of a side impact of a certain severity. The ignition must be switched on.



The inflated airbags cushion the impact, thereby reducing the risk of injury to the upper body and pelvis in the event of a side-on collision considerably.

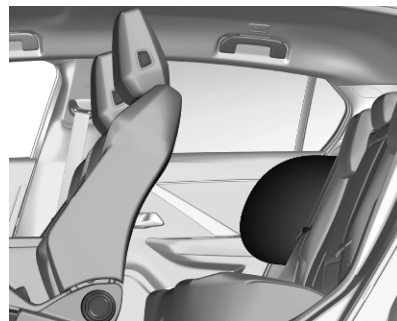

Notice

Only use protective seat covers that have been approved for the vehicle. Be careful not to cover the airbags.

Curtain airbag system

The curtain airbag system consists of an airbag in the roof frame on each side. This can be identified by the word **AIRBAG** on the roof pillars.

The curtain airbag system is triggered in the event of a side-on impact of a certain severity. The ignition must be switched on.

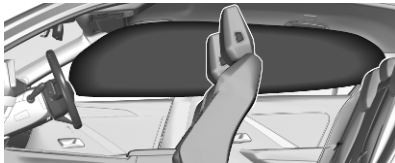

The inflated airbags cushion the impact, thereby reducing the risk of injury to the head in the event of a side-on impact considerably.

Warning

The hooks on the handles in the roof frame are only suitable for hanging up light articles of clothing, without coat hangers. Do not keep any items in these clothes.

Airbag deactivation

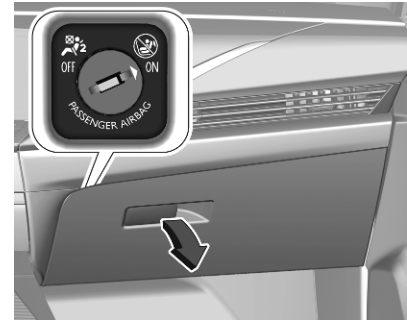

The front passenger airbag system must be deactivated for child restraint according to the instructions in the table ⇨ 50.

The side airbag and curtain airbag systems, the belt pretensioners and all driver airbag systems will remain active.



The front passenger airbag system can be deactivated via a key-operated switch in the glovebox.

Use the ignition key to choose the position:

OFF  : front passenger airbag is deactivated and will not inflate in the event of a collision, control indicator OFF  illuminates continuously in the centre console.

ON  : front passenger airbag is active.

Notice

After turning the key-operated switch to position OFF , keep on turning towards this position until key is removed.

⚠ Danger

Deactivate passenger airbag only in combination with the use of a child restraint system, subject to the instructions and restrictions in the table ⇨ 50.

Otherwise, there is a risk of fatal injury for a person occupying a seat with a deactivated front passenger airbag.



If the control indicator  illuminates for approx. 60 seconds after the ignition is switched on, the front passenger airbag system will inflate in the event of a collision.

If the control indicator  illuminates after the ignition is switched on, the front passenger airbag system is deactivated. It stays on while the airbag is deactivated.

If both control indicators are illuminated at the same time, there is a system failure. The status of the system is not discernible, therefore no person is allowed to occupy the front passenger seat. Contact a workshop immediately.

Consult a workshop immediately if neither of the two control indicators are illuminated.

Change status only when the vehicle is stopped with the ignition off.

Status remains until the next change.

Control indicator for airbag deactivation ⇨ 80.

Child restraints**Child restraint systems****⚠ Danger**

If using a rear-facing child restraint system on the front passenger seat, the airbag system for the front passenger seat must be deactivated. This also applies to certain forward-facing child restraint systems as indicated in the tables ⇨ 50.

Airbag deactivation ⇨ 45.

Airbag label ⇨ 40.

We recommend a child restraint system which is tailored specifically to the vehicle. For further information, contact your workshop.

In case of any interference of the child restraint system with vehicle seat head restraint, adjust or remove the corresponding head restraint ⇨ 30.

When a child restraint system is being used, pay attention to the following usage and installation instructions

and also those supplied with the child restraint system. The given restrictions in the table refer to a test body, which is the maximum envelope of all existing child restraint systems. Make sure that the front seats do not interfere with the used child restraint system.

Always comply with local or national regulations. In some countries, the use of child restraint systems is forbidden on certain seats.

Only drive with the driver seat correctly adjusted ⇨ 31.

Child restraint systems can be fastened with:

- Three-point seat belt
- ISOFIX brackets
- Top-tether

Three-point seat belt

Child restraint systems can be fastened by using a three-point seat belt. After fastening the child restraint system the seat belt has to be tightened.

ISOFIX brackets

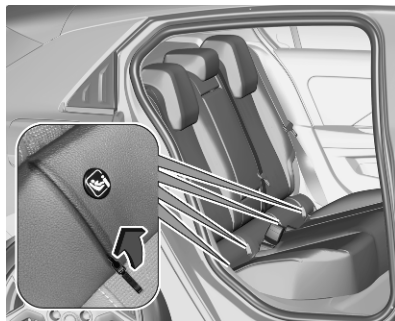

Fasten vehicle-approved ISOFIX child restraint systems to the ISOFIX brackets. Specific vehicle ISOFIX child restraint system positions are marked in the ISOFIX table ⇨ 50.

ISOFIX brackets are indicated by a label on the backrest. To get access to the ISOFIX brackets, first pull the zipper.

When fastening ISOFIX child restraint systems on adjustable passenger seats, first incline the backrest as far as necessary backwards in order to get access to the ISOFIX brackets.

After the proper fastening of the ISOFIX child restraint system, incline the backrest forward again.

An i-Size child restraint system is an universal ISOFIX child restraint system according UN Regulation No. 129.

All i-Size child restraint systems can be used on any vehicle seat suitable for i-Size, i-Size table ⇨ 50.

Either a Top-tether strap or a support leg must be used in addition to the ISOFIX brackets.



i-Size child seats and vehicle seats with i-Size approval are marked with i-Size symbol, see illustration.

Top-tether anchors



Top-tether anchors are marked with the symbol  for a child seat.

In addition to the ISOFIX brackets, fasten the Top-tether strap to the Top-tether anchors.

ISOFIX child restraint systems of universal category positions are marked in the table by IUF ⇨ 50.

Selecting the right system

The rear seats are the most convenient location to fasten a child restraint system.

Children should travel facing rearwards in the vehicle as long as possible. This makes sure that the child's backbone, which is still very weak, is under less strain in the event of an accident. Do not use forward facing child restraint system at all seats when child's weight is below 13 kg.

Suitable are child restraint systems that comply with valid UN ECE regulations. Check local laws and regulations for mandatory use of child restraint systems.

The following child restraints are recommended for the following weight classes:

- **Group 0, Group 0+:**
Maxi Cosi Cabriofix with or without ISOFIX base for children up to 13 kg.
- **Group I:** Britax Duo Plus with ISOFIX and Top-tether for children from 9 kg to 18 kg.
- **Group II:** Kidfix 2R with or without ISOFIX for children from 15 kg to 36 kg.

Graco Booster for children from 15 kg to 36 kg.

- **Group III:** Kidfix 2R with or without ISOFIX for children from 22 kg to 36 kg.

Graco Booster for children from 22 kg to 36 kg.

Ensure that the child restraint system to be installed is compatible with the vehicle type.

Child seat at the front: Adjust the front passenger seat to the highest and fully back longitudinal position with the backrest straightened.

Child seat at the rear: Move the vehicle's front seat forward and straighten the backrest so that the legs of the child in the "forward facing" or the "rearward facing" child seat do not touch the vehicle's front seat.

In case of any interference of child restraint system with vehicle seat head rest, adjust or remove the corresponding vehicle seat head restraint.

Do not use forward facing child restraints system when child's weight is below 13 kg at all seats.

Please follow child restraint manufacturers instructions to install corresponding child restraints in vehicle.

For semi-universal or vehicle specific child restraint system (ISOFIX or belted child restraint system), see the vehicle list provided in the user manual of the child restraint system.

Ensure that the mounting location of the child restraint system within the vehicle is correct, see following table.

Allow children to enter and exit the vehicle only on the side facing away from the traffic.

When the child restraint system is not in use, secure the seat with a seat belt or remove it from the vehicle.

Notice

Do not affix anything on the child restraint systems and do not cover them with any other materials.

A child restraint system which has been subjected to stress in an accident must be replaced.

Child restraint installation locations

Installation of universal, ISOFIX and i-Size child seats

As required by European regulations, this table gives the options for installing child seats secured using the seat belt and universally approved as well as the larger ISOFIX and i-Size child seats on seat positions equipped with ISOFIX mountings in the vehicle.

Yes : Suitable for fitment of the designated category of the child restraint system.

No : Not suitable for fitment of the designated category of the child restraint system.

5-door Hatchback

	Front passenger seat	Rear outer seats	Rear centre seat
Position compatible with a universal child seat ¹⁾	Yes ^{2) 3) 4) 5) 6)}	Yes	Yes ⁷⁾
Position compatible with an i-Size child seat	No	Yes	No
Position equipped with a top-tether fixing	No	Yes	No
Carrycot type of child seat	No	No	No
Rearward facing ISOFIX child seat	No	R3 ^{8) 9)}	No
Forward facing ISOFIX child seat	No	F3 ⁹⁾	No
Booster child seat	B3 ^{9) 10)}	B3 ⁹⁾	B3 ^{9) 10)}

1) Universal child seat: child seat that can be installed in all vehicles using the seat belt.

2) To install a rearward facing child seat at this seat position, the front passenger's airbag must be deactivated OFF.

3) Only a forward facing child seat is authorised at this seat position with the front passenger's airbag activated ON.

4) Put the front seat to the rearmost and upmost position.

5) Adjust the seat backrest inclination as far as necessary to a vertical position to ensure that the seat belt is tight on the buckle side.

6) Move the seat forward and adjust the seat backrest inclination as far as necessary to ensure that the seat belt runs forward from the upper anchorage point to the child seat.

- 7) A child seat with a support leg must never be installed on the centre rear passenger seat.
 8) Depending on position, adjust the height-adjustable front driver seat to the maximum height position or adjust the front passenger seat as far forward as necessary.
 9) In case of any interference of the child restraint system with vehicle seat head restraint, adjust or remove the corresponding head restraint.
 10) Seats not fitted with ISOFIX compliant mountings.

Sports Tourer

	Front passenger seat	Rear outer seats	Rear centre seat
Position compatible with a universal child seat ¹¹⁾	Yes ^{12) 13) 14)}	Yes	Yes ¹⁵⁾
Position compatible with an i-Size child seat	No	Yes	No ¹⁵⁾
Position equipped with a top-tether fixing	No	Yes	No
Carrycot type of child seat	No	No	No
Rearward facing ISOFIX child seat	No	R3 ¹⁶⁾	No
Forward facing ISOFIX child seat	No	F3	No
Booster child seat	B3 ^{17) 18)}	B3	No

11) Universal child seat: child seat that can be installed in all vehicles using the seat belt.

12) To install a rearward facing child seat at this seat position, the front passenger's airbag must be deactivated OFF.

13) Only a forward facing child seat is authorised at this seat position with the front passenger's airbag activated ON.

14) For a seat with height adjustment, set it to the highest and fully back longitudinal position.

15) A child seat with a support leg must never be installed on the centre rear passenger seat.

16) Depending on position, adjust the height-adjustable front driver seat or front passenger seat to the maximum height position.

17) Seats not fitted with ISOFIX compliant mountings.

18) Remove headrest.

Rules:

- A position that is i-Size compatible is also compatible for R1, R2 and F2X, F2, B2.
- A position that is R3 compatible is also compatible for R1, R2 and R2X.
- A position that is R2 compatible is also compatible for R1.
- A position that is F3 compatible is also compatible for F2X and F2.
- A position that is B3 compatible is also compatible for B2.

Size of child restraint fixture (1, 2, 3):

- R1 means rearward facing child restraint fixture for mass group 0 up to 10 kg and mass group 0+ up to 13 kg, age around 0-1 year.
- R2 means reduced size of rearward facing child restraint fixture for mass group 0+ up to 13 kg and mass group 1 from 9 to 18 kg, age around 2-4 years.
- R3 means full size of rearward facing child restraint fixture for mass group 0+ up to 13 kg and mass group 1 from 9 to 18 kg, age around 2-4 years.
- F2, F2X mean reduced height of forward facing child restraint fixture for mass group 1 from 9 to 18 kg, age around 6-7 years.
- F3 means full height of forward facing child restraint fixture for mass group 1 from 9 to 18 kg, age around 7-10 years.

Storage

Storage compartments	53
Glovebox	53
Cupholders	53
Front storage	54
Door panel storage	55
Centre console storage	55
Load compartment	56
Load compartment cover	57
Rear floor storage cover	60
Lashing eyes	60
Safety net	61
Warning triangle	62
First aid kit	62
Roof rack system	62
Roof rack	62
Loading information	63

Storage compartments

⚠ Warning

Do not store heavy or sharp objects in the storage compartments.

Glovebox

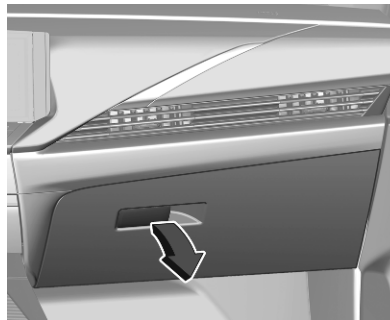

Pull the lever to open the glovebox.

The glovebox should be closed whilst driving.

Cupholders

Depending on version, cupholders are located in the centre console:



- As an open storage compartment before the front armrest.

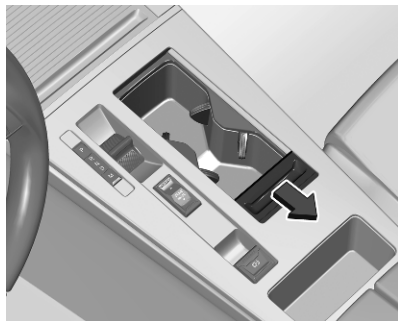

- Within a storage compartment closed by a sliding cover. Slide the cover backwards.



A combined storage for cupholders and mobile device is located in the rear armrest. Fold down the armrest.

Front storage

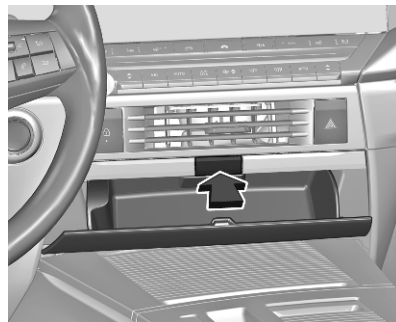

A storage compartment is located at the instrument panel.

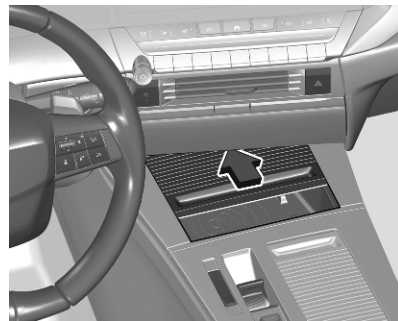

A storage compartment for inductive charging is located beneath the instrument panel.

Inductive charging ⇨ 72.

Depending on version, the storage compartment may have a sliding cover.

Slide the cover forwards.



Depending on version, a coin holder may be located on the left side of the instrument panel.

Door panel storage

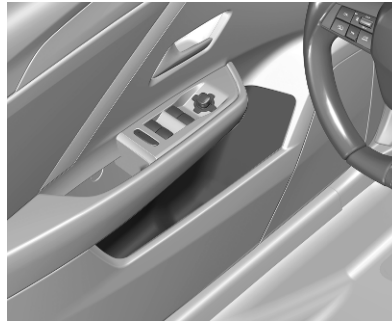

A storage compartment is located in the front and rear door panels.

Centre console storage

A storage compartment is located in the front armrest at the centre console.

Depending on version, there are different ways to open:

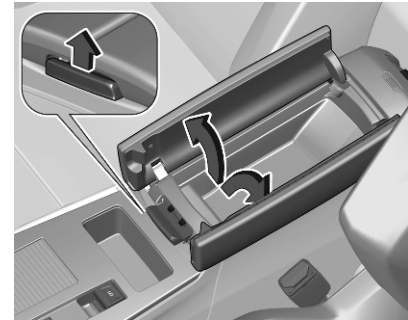

- Push the button to release the cover.
Fold the cover aside in two parts.

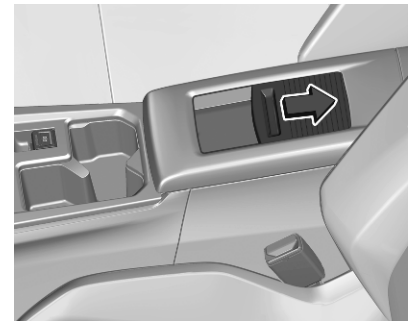

- Open the cover by sliding it backwards.

Depending on version, an additional storage compartment may be located before the armrest.

Load compartment

Depending on version, the rear seat backrest is divided into two or three parts. All parts can be folded down individually to increase the size of the load compartment.

Before folding the rear seat backrests, execute the following if necessary:

- Move the front seats forwards if necessary.
- Remove the load compartment cover ↷ 57.
- Press and hold the catch to push the head restraints down ↷ 30.

Folding down / up the rear backrests from the passenger compartment

- Check that the seat belts are not engaged in the seat belt buckles, so that the backrests can be moved.



- Pull the release lever and fold down the backrests onto the seat cushion.
- To fold up, raise the backrests and guide them into an upright position until they engage audibly. Make sure that the belts are positioned correctly and stay clear of the folding area.

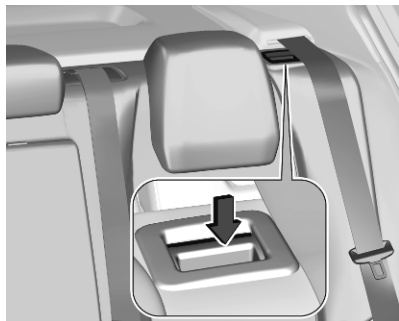

The backrests are properly engaged when the red marks near the release levers are no longer visible.

⚠ Warning

When folding up, ensure that backrests are securely locked in position before driving. Failure to do so may result in personal injury or damage to the load or vehicle in the event of hard braking or a collision.

Folding down the rear backrests from the load compartment (Sports Tourer)

To fold down the left or right rear backrests from the load compartment, pull the release lever in the corresponding load compartment side panel.

The centre backrest will be folded down along with the left backrest.

Opening the pass through in the centre backrest



Fold down the rear armrest.

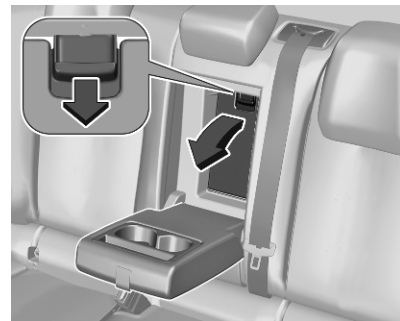

Pull the handle and open the cover. Suitable for loading long, narrow objects.

Load compartment cover

Do not place any objects on the cover.

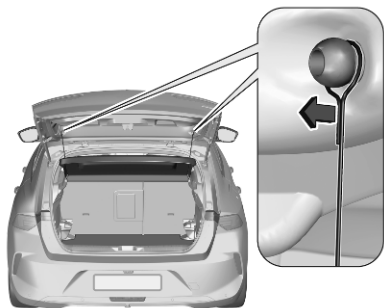
5-door Hatchback**Removing the cover**

Unhook the retaining straps from the tailgate.

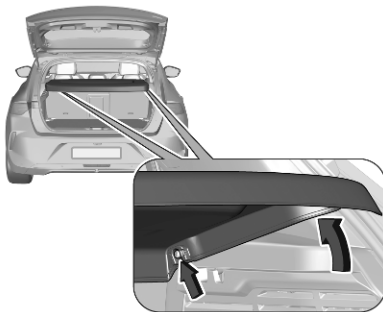

Lift the cover at the front and push it upwards at the rear.

Remove the cover.

Fitting the cover

Engage the cover in the side guides and fold downwards. Attach the retaining straps to the tailgate.

Sports Tourer**Closing roller blind**

Pull the roller blind using the handle towards the rear and upwards until it engages in the sideward retainers.

Opening roller blind

Pull the roller blind handle to the rear and downwards. It rolls up automatically.

Removing roller blind

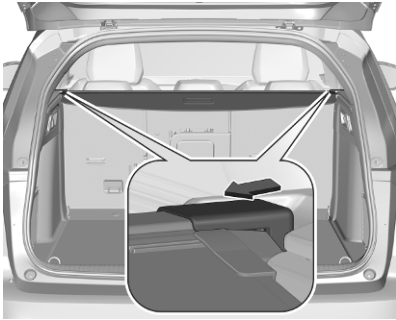

Open the roller blind.

Press the lever on the right side and lift the roller blind first at the right side and then on the left side. Remove the roller blind from the recesses.



The removed roller blind can be stored under the rear floor cover as shown in the illustration.



Depending on version, the roller blind needs to be stored upside down and crosswise from the left to the right load compartment side.



Lift the rear floor cover and remove the covers at both load compartment sides to get access to the recesses.

Place the roller blind so that it fits into the recesses at both sides and reattach the covers.

Rear floor storage cover ⇨ 60.

Installing roller blind

Insert the left side of the roller blind in the recess, then press the lever and insert the right side of the roller blind in the recess.

Rear floor storage cover

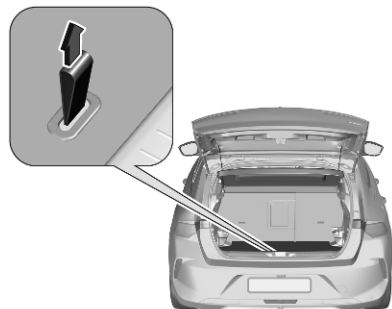

The rear floor cover can be lifted and removed. Use the loop to raise the rear floor cover and then remove it.

Depending on version, the rear floor storage cover may be foldable.

Double load floor

The double load floor can be inserted in the load compartment in two positions:

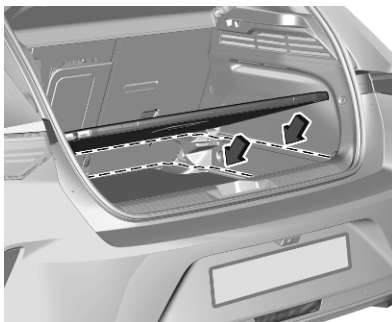

- lower position above the rear floor storage cover
- upper position interlocked into the back panel trim

To remove, use the opening to raise the rear floor cover and lift it up.

If mounted in the upper position, the space between the load floor and the spare wheel well cover can be used as a storage compartment.

In this position and with rear backrests folded, an almost completely flat load bay is created.

5-door Hatchback

The load of the double load floor in the upper position is limited to a maximum of 100 kg.

Sports Tourer

The load of the double load floor in the upper position is limited to a maximum of 150 kg.

Lashing eyes

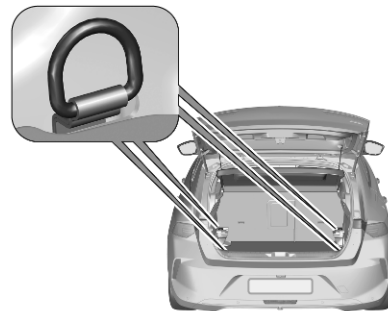

The lashing eyes are designed to secure items against slippage, e.g. using lashing straps or luggage net.

Safety net

The safety net can be installed behind the rear seats or, if the rear seat backrests are folded, behind the front seats.

Passengers must not be transported behind the safety net.

Installation

Behind the rear seats

- Remove the roller blind.
Load compartment cover ⇨ 57.

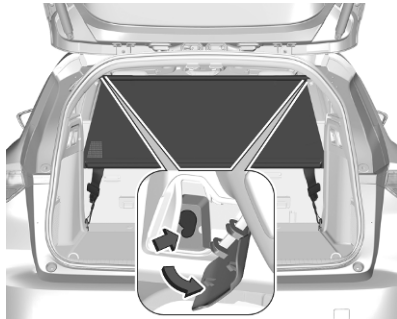

- There are installation openings on both sides in the roof frame above the rear seats: suspend

and engage rod of net at one side, compress rod and suspend and engage at the other side.

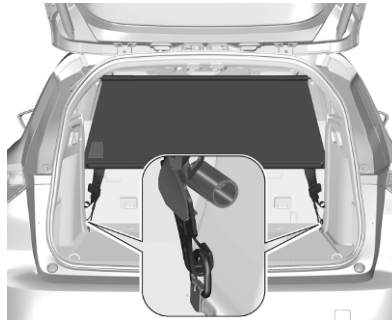

- Attach the hooks of the safety net straps in the lashing eyes behind the rear seats.
- Tension both straps by pulling at the loose end.
- Rear seat backrests must be raised up.

Behind the front seats

- Push down head restraints and fold down the rear backrests.
Load compartment ⇨ 56.



- There are installation openings on both sides in the roof frame above the front seats: suspend and engage rod of net at one side, compress rod and suspend and engage at the other side.

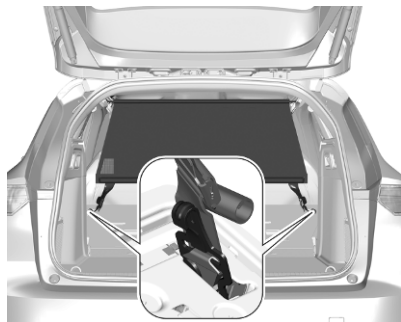

First aid kit

Depending on version, the first aid kit can be stored in a free space under the rear floor storage cover.

- Insert the hooks of the safety net straps into the buckles on the back side of the rear backrests.
- Tension both straps by pulling at the loose end.

Warning triangle

5-door Hatchback

Store the warning triangle in the destined space on the right side under the rear floor storage cover.

Sports Tourer

Store the warning triangle in the destined compartment on the inner tailgate panel.

Roof rack system

Roof rack

For safety reasons and to avoid damage to the roof, a vehicle approved roof rack system is recommended. For further information, contact your workshop.

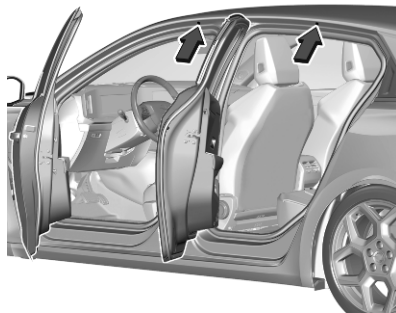

Open all doors.

Mounting points are located in each door frame of the vehicle body.

Fasten the roof rack according to the installation instructions delivered with the roof rack.

Remove the roof rack when not in use.

Sports Tourer

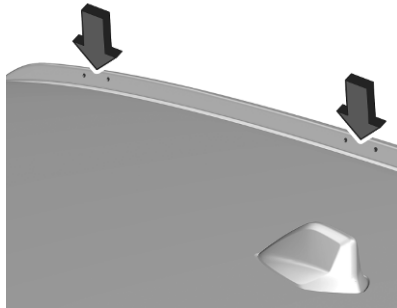

Markings at the roof rails indicate where the roof rack is to be installed.

Loading information

⚠ Warning

Always make sure that the load in the vehicle is securely stowed. Otherwise objects can be thrown around inside the vehicle and cause personal injury or damage to the load or car.



- Heavy objects in the load compartment should be placed against the seat backrests. Make sure that the backrests are

securely engaged. If objects can be stacked, heavier objects should be placed at the bottom.

- Prevent sliding of loose objects by securing them with straps attached to the lashing eyes ⇨ 60.
- Do not allow the load to protrude above the upper edge of the backrests.
- Do not place any objects on the load compartment cover or the instrument panel, and do not cover the sensor on top of the instrument panel.
- The load must not obstruct the operation of the pedals, parking brake and gear selector, or hinder the freedom of movement of the driver. Do not place any unsecured objects in the interior.
- Do not drive with an open load compartment.
- The payload is the difference between the permitted gross vehicle weight (see identification plate ⇨ 240) and the EC kerb weight.

To calculate the payload, enter the data for your vehicle in the weights table at the front of this manual.

The EC kerb weight includes weights for the driver (68 kg), luggage (7 kg) and all fluids (fuel tank 90% full).

Optional equipment and accessories increase the kerb weight.

- Driving with a roof load increases the sensitivity of the vehicle to cross-winds and has a detrimental effect on vehicle handling due to the vehicle's higher centre of gravity.

Distribute the load evenly and secure it properly with retaining straps. Adjust the tyre pressure and vehicle speed according to the load conditions. Check and retighten the straps frequently.

Do not drive faster than 75 mph.

The permissible roof load is 80 kg. The roof load is the combined weight of the roof rack and the load.

Instruments and controls

Instrument panel overview	66
Controls	68
Steering wheel adjustment	68
Steering wheel controls	68
Heated steering wheel	68
Horn	69
Pedestrian safety alert	69
Windscreen wiper and washer ..	69
Rear window wiper and washer	71
Outside temperature	71
Clock	71
Power outlets	71
Inductive charging	72
Ashtrays	73
Warning lights, gauges and indicators	74
Speedometer	74
Odometer	74
Tachometer	74
Fuel gauge	75
High voltage battery gauge	75
Power indicator gauge	75
Total vehicle range	76

Engine coolant temperature gauge	76
Engine oil level monitor	76
Service display	76
Control indicators	77
Turn lights	79
Seat belt reminder	79
Airbag and belt tensioners	80
Airbag deactivation	80
Charging system	80
Malfunction indicator light	80
Service vehicle soon	81
Stop engine	81
Hybrid system active	81
Hybrid system fault	81
Brake and clutch system	81
Parking brake	81
Electric parking brake fault	82
Automatic operation of electric parking brake off	82
Antilock brake system (ABS)	82
Gear shifting	82
Power steering	82
Lane keep assist	82
Advanced lane keep assist	82
Parking assist	83
Electronic Stability Control and Traction Control system	83
Engine coolant temperature	83
Preheating	83

AdBlue	83
Deflation detection system	84
Engine oil pressure	84
Low fuel	84
Charging cable connected	84
Apply footbrake	84
Autostop	85
Exterior light	85
Low beam	85
High beam	85
High beam assist	85
Rear fog light	85
Pedestrian safety alert fault	85
Active emergency braking	85
Door open	85
Displays	86
Driver Information Centre	86
Info Display	86
Head-up display	88
Vehicle messages	89
Warning chimes	90
Trip computer	90
Vehicle personalisation	91
Telematics services	92
Emergency call	92
Vauxhall Connect	92

Instrument panel overview

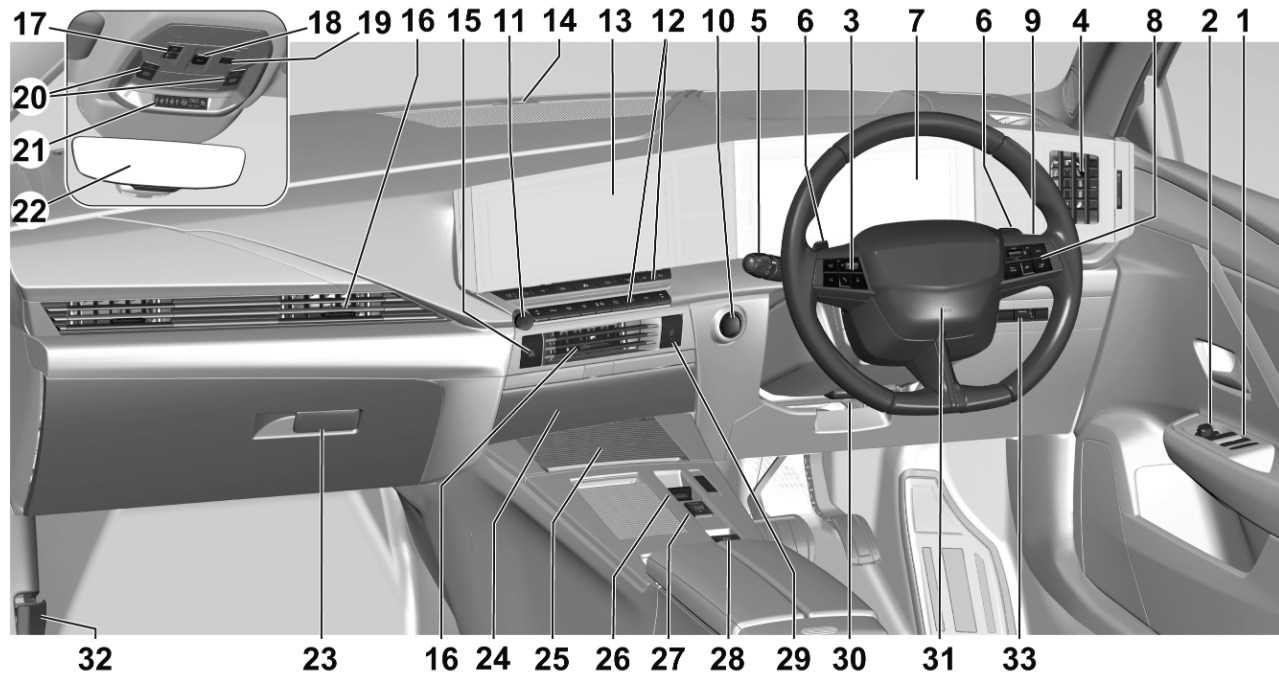

1	Power windows	26	12	Heated rear window	27	24	Front storage	54
2	Exterior mirrors	23		Heated windscreen	28	25	Front storage	54
	Head-up display	88		Heated seats	36		Power outlets	71
3	Cruise control	148		Ventilated seats	36		Inductive charging	72
	Speed limiter	150		Heated steering wheel	68	26	Gear selection	138
	Adaptive cruise control	152		Vehicle personalisation	91		Selector lever	141
4	Side air vents	119		Electronic climate control system	114	27	Drive modes	141
5	High beam	95	13	Info Display	86	28	Parking brake	143
	Headlight flash	96	14	Anti-theft alarm system status LED	21	29	Central locking button	10
	Turn lights	99	15	Hazard warning flashers	99	30	Steering wheel adjustment ...	68
	Fog lights	99	16	Centre air vents	119	31	Horn	69
	Parking lights	100	17	Emergency call	92	32	Bonnet release lever	207
6	Steering wheel paddles	139	18	Sunroof	28	33	Power tailgate	16
7	Driver Information Centre	86	19	Anti-theft alarm system	21		Coin holder	54
8	Infotainment controls	103	20	Interior lights	101		Headlight range adjustment ..	96
9	Windscreen wiper and washer	69	21	Seat belt reminder	79		Temperature preconditioning	118
	Rear window wiper and washer	71		Airbag deactivation	80		Fuel filler flap	195
10	Power button	124	22	Interior mirror	25			
11	Infotainment on / off and volume	103	23	Airbag deactivation	45			
				Glovebox	53			

Controls

Steering wheel adjustment

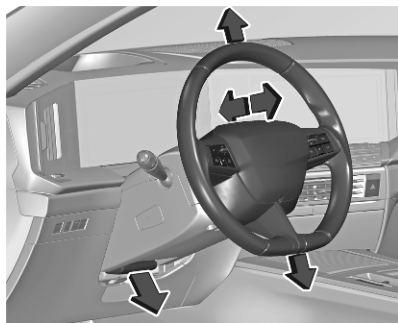

Unlock lever, adjust steering wheel, then engage lever and ensure it is fully locked.

Do not adjust steering wheel unless vehicle is stationary and steering wheel lock has been released.

Steering wheel controls

Some driver assistance systems, the Infotainment system and a connected mobile phone can be operated via the controls on the steering wheel.



Infotainment system ⇨ 103.

Cruise control ⇨ 148.

Speed limiter ⇨ 150.



Adaptive cruise control ⇨ 152.

Heated steering wheel



Activate the heating by pressing . Activation is indicated by the control indicator in the button.

Activation via the Info Display

The heating can be activated or deactivated by touching  in the climate menu .

Activation is indicated by  in the status bar.

Infotainment system ⇨ 104.

Horn

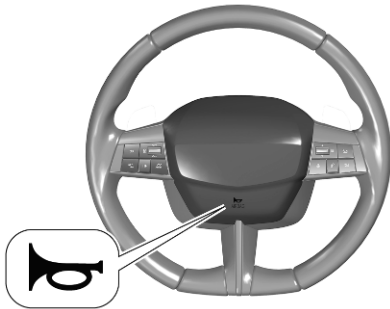

Press .

Pedestrian safety alert

The sound of the pedestrian safety alert is generated to indicate the vehicle presence to pedestrians. It is active up to 19 mph.

Windscreen wiper and washer

Windscreen wiper with adjustable wiper frequency

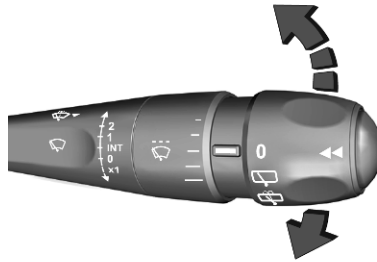

- 2** : fast
- 1** : normal
- INT** : intermittent wiping
- 0** : off
- x1** : single wipe

Do not use if the windscreen is frozen.
Switch off in car washes.

Adjustable wiper frequency



Wiper lever in position **INT**, it is possible to select five frequency levels by turning the ring.

Windscreen wiper with rain sensor

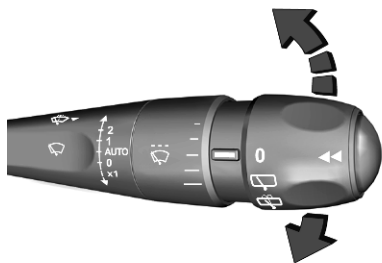

- 2 : fast
- 1 : normal
- AUTO** : automatic wiping
- 0 : off
- x1 : single wipe

In **AUTO** position, the rain sensor detects the amount of water on the windscreen and automatically regulates the frequency of the windscreen wiper.

Do not use if the windscreen is frozen.
Switch off in car washes.

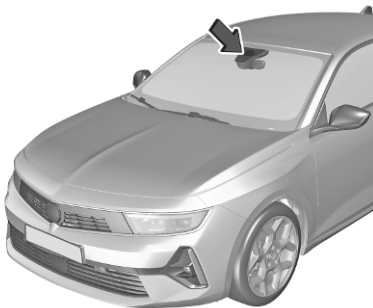

Keep the sensor free from dust, dirt and ice.

Adjustable sensitivity of the rain sensor



Turn the adjuster wheel to adjust the sensitivity.

The longest dash indicates the highest sensitivity and the shortest dash indicates the lowest sensitivity.

Windscreen washer



Pull lever. Washer fluid is sprayed onto the windscreen and the wiper wipes a few times.

Washer fluid ⇨ 210.

Rear window wiper and washer

Rear window wiper



- 0 : off
- : intermittent wiping
- : screen wash

Do not use if the rear window is frozen.

Switch off in car washes.

The rear window wiper comes on automatically when the windscreen wiper is switched on and reverse gear is engaged.

Rear window washer

Select .

Washer fluid is sprayed onto the rear window and the wiper wipes as long as is selected.

The rear view camera will be washed when the rear window washer is operating.

Washer fluid ⇨ 210.

Outside temperature

The outside temperature is shown in the status bar in the Info Display.

Warning

The road surface may already be icy even though the display indicates a few degrees above 0 °C.

System settings ⇨ 104.

Clock

The time is shown in the status bar in the Info Display.

System settings ⇨ 104.

Power outlets

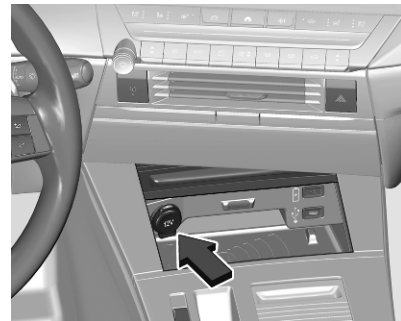

A 12 V power outlet is located in the centre console.

Depending on version, another 12 V power outlet is located in the load compartment.

Do not exceed the maximum power consumption of 120 W.

The 12 V power outlet is deactivated in the event of low vehicle battery voltage.

Electrical accessories that are connected must comply with the electromagnetic compatibility requirements laid down in DIN VDE 40 839.

Do not connect any current-delivering accessories, e.g. electrical charging devices or batteries.

Do not damage the outlet by using unsuitable plugs.

USB ports

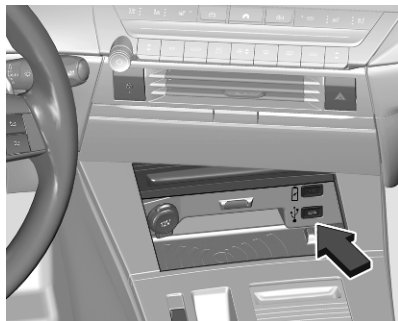

The USB ports can be used to charge portable devices.

To connect a portable device to the Infotainment system, use the USB port marked with .

Notice

The sockets must always be kept clean and dry.

Rear USB port

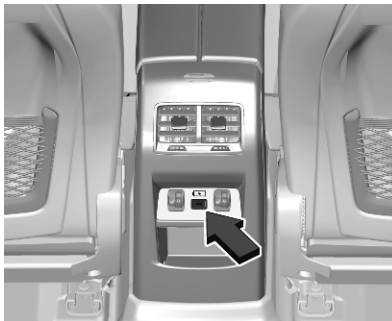

The USB port can be used to charge a portable device.

Inductive charging

Warning

Inductive charging can affect the operation of implanted pacemakers or other medical devices. If applicable, seek medical advice before using the inductive charging device.

Warning

Remove any metal objects from the charging device before charging a mobile device, as these objects could become very hot.

To charge a mobile device:

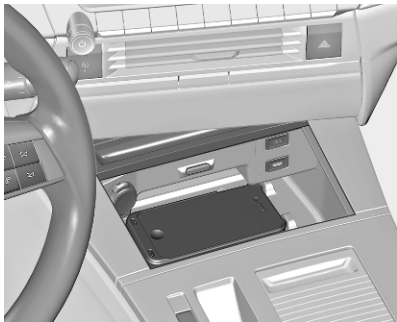

1. Remove all objects from the charging device.
2. Place the mobile device with the display facing upwards on the charging area. Note that the mobile device must be placed between the positioning aids.

Qi compatible mobile devices can be charged inductively.

On some mobile devices, a back cover with an integrated coil or a jacket may be required to use inductive charging.

Protective cover for the mobile device could have impact on the inductive charging.

In the event that the mobile device is not charging properly, rotate it 180° and place it on the charging device again.

Status LED

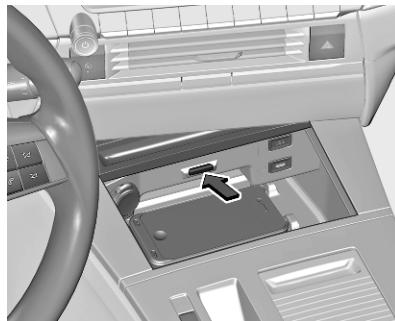

The LED indicates the current charging status.

Illuminates green

The mobile device is charging.

Flashes yellow

The mobile device has not been centred properly in the charging zone or an unknown object has been detected in the charging zone.

Illuminates yellow

There is a problem with the mobile device's battery or a fault of the inductive charger has been detected.

If the problem persists, seek the assistance of a workshop.

Ashtrays

Caution

To be used only for ash and not for combustible rubbish.

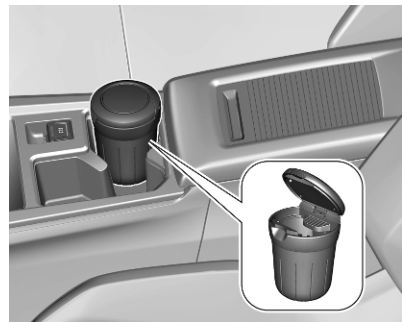

A portable ashtray can be placed in the cupholders.

Warning lights, gauges and indicators

Speedometer

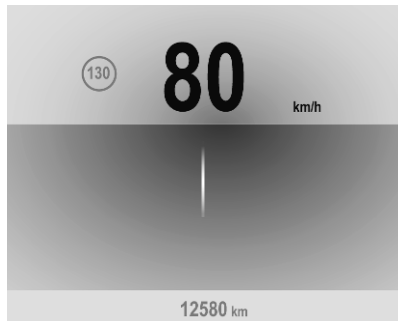

Indicates vehicle speed.

Odometer

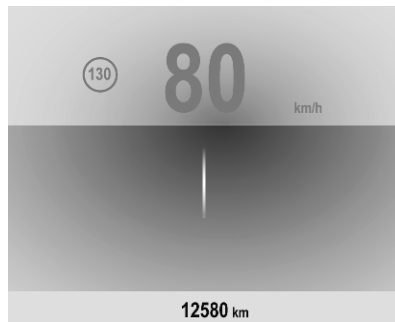

The total recorded distance is displayed in miles.

Tachometer

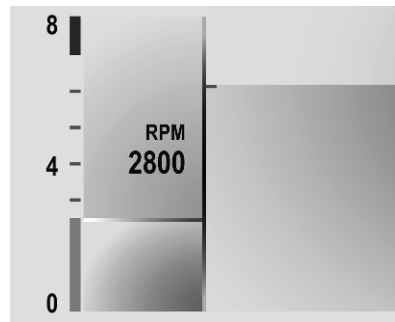

Displays the engine speed.

Drive in a low engine speed range for each gear as much as possible.

A red marker indicates the beginning of the warning zone of excessive revolutions. For Diesel engines, the warning zone starts at 5000 revolutions per minute. For petrol engines, the warning zone starts at 6500 revolutions per minute.

Caution

If the indicator is in the red warning zone, the maximum permitted engine speed is exceeded. The engine can be damaged.

Fuel gauge



Never run the fuel tank dry.

The top-up quantity may be less than the specified fuel tank capacity, due to the remaining fuel in the tank.

High voltage battery gauge

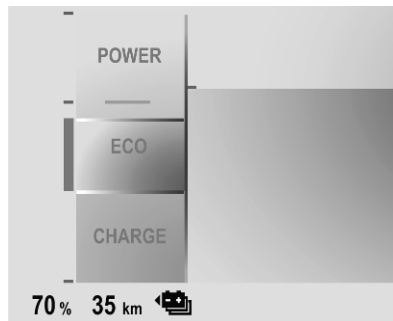

Displays the high voltage battery state of charge.

Power indicator gauge

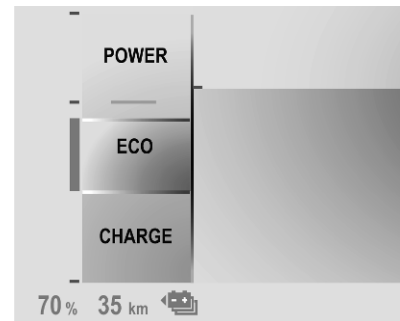

The power indicator gauge informs about the current energy situation of the vehicle.

- Charge : Battery is being charged with energy resulting from braking or deceleration of the vehicle
- Eco : An optimum in energy is accessible in all driving modes
- Power : Vehicle is driven in a dynamic driving style with focus on performance

Total vehicle range

Displays the total vehicle range.

Engine coolant temperature gauge

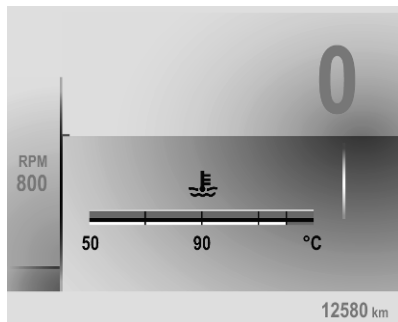

Displays the coolant temperature.

grey marking / : normal operating temperature
90
red marking : temperature too high

Control indicator  illuminates red if coolant temperature is too high.



Caution

If engine coolant temperature is too high, stop vehicle, switch off engine. Danger to engine. Check coolant level.

Engine oil level monitor

The state of the engine oil level is displayed in the Driver Information Centre for a few seconds following the service information after switching on the ignition.

A proper state of engine oil level is indicated by a message.

If engine oil level is low,  flashes and a message is indicated, accompanied by the  indicator.

Confirm engine oil level by using the dipstick and top up engine oil respectively.

Engine oil ⇨ 208.

A fault of measurement is indicated by a message. Check engine oil level manually by using the dipstick.

Service display

The service system informs when to change the engine oil and filter or a vehicle service is required. Based on driving conditions, the interval at which an engine oil and filter change are required can vary considerably.

Service information ⇨ 235.

A required service due is displayed in the Driver Information Centre for several seconds after switching on the ignition.

If no service is required for the next 1800 miles or more, no service information appears in the display.

If service is required within the next 1800 miles, the remaining distance to the next service due, the distance travelled since the last service due or the time period that remains to the next service due is indicated for several seconds. Simultaneously symbol  illuminates temporary as reminder.

If service is required in less than 600 miles, the remaining distance to the next service due, the distance travelled since the last service due or

the time period that remains to the next service due is indicated for several seconds. Simultaneously  illuminates permanently as reminder.

Overdue service is indicated by a message in the Driver Information Centre which indicates the overdue distance.  flashes and then illuminates permanently until service is executed.

Reset of service interval

After each service, the service indicator must be reset to ensure proper functionality. It is recommended to seek the assistance of a workshop.

If service is executed by yourself, operate as following:

- switch off ignition



- press and hold the button
- switch on ignition, the distance indication begins a countdown
- when the display indicates =0, release the button again

The symbol  disappears.

Retrieving service information

The status of the service information can be retrieved at any time via the Info Display. Press **Check** in the vehicle settings menu. The service information is displayed for a few seconds.

Info Display ⇨ 86.

Service information ⇨ 235.

Control indicators

The control indicators described are not present in all vehicles. Depending on the equipment, the position of the control indicators may vary. When the ignition is switched on, most control indicators will illuminate briefly as a functionality test.

The control indicator colours mean:

- red : danger, important reminder
- yellow : warning, information, fault
- green : confirmation of activation
- blue : confirmation of activation
- white : confirmation of activation
- grey : system paused, at least one system limitation has been detected

Control indicators are located in the Driver Information Centre.







Driver Information Centre ⇨ 86.

Overview

The numbers in the overview table indicate what to do, when a control indicator illuminates or flashes.

- 1 : only for information
- 2 : information and warning

- 3 : seek the assistance of a workshop
- 4 : stop engine and seek the assistance of a workshop
- 5 : have the cause of the fault remedied immediately by a workshop
- 6 : stop vehicle, do not continue the journey and seek the assistance of a workshop

-  1 Turn lights ⇄ 79
-  2 Seat belt reminder ⇄ 79
-  5 Airbag and belt tensioners ⇄ 80
-  2 Airbag activated ⇄ 80
-  2 Airbag deactivated ⇄ 80
-  4 Charging system ⇄ 80
-  5 Malfunction indicator light ⇄ 80



- 5 Service vehicle soon ⇄ 81



- 4 Stop engine ⇄ 81

- READY** 1 Hybrid system active ⇄ 81



- 5 Hybrid system fault ⇄ 81



- 6 Brake and clutch system ⇄ 81



- 1 / 5 Parking brake ⇄ 81



- 5 Electric parking brake fault ⇄ 82



- 2 Automatic operation of electric parking brake off ⇄ 82



- 2 Antilock brake system (ABS) ⇄ 82



- 4 Power steering ⇄ 82



- 2 Lane keep assist ⇄ 82



- 2 Advanced lane keep assist ⇄ 82



- 2 Parking assist off ⇄ 83



- 2 / 5 Electronic Stability Control and Traction Control system ⇄ 83



- 2 Electronic Stability Control and Traction Control system ⇄ 83



- 4 Engine coolant temperature high ⇄ 83



- 1 Preheating ⇄ 83



- 1 AdBlue ⇄ 83



- 2 / 3 Deflation detection system ⇄ 84



- 4 Engine oil pressure ⇄ 84













- 2 Low fuel ⇄ 84



- 2 Charging cable connected ⇄ 84



- 1 Apply footbrake ⇄ 84

-  1 Autostop ⇨ 85
-  1 / Stop-start system
3 deactivated ⇨ 85
-  1 Exterior light ⇨ 85
-  1 Low beam ⇨ 85
-  1 High beam ⇨ 85
-  1 High beam assist
⇨ 85
-  1 Rear fog light ⇨ 85
-  3 Pedestrian safety alert
fault ⇨ 85
-  2 / Active emergency
3 braking ⇨ 85
-  2 Door open ⇨ 85
-  1 e-SAVE is activated
⇨ 86

Turn lights

← or → flashes green.

Flashes if a turn light is activated.

An audible warning can be heard when the turn lights are on.

Turn lights ⇨ 99.



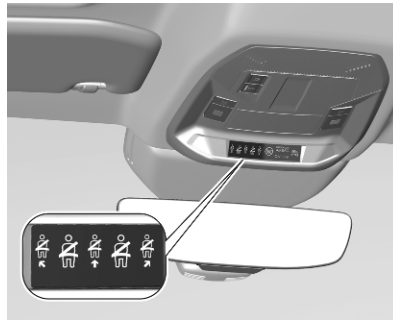

Seat belt reminder



 illuminates or flashes in the Driver Information Centre together with the indication in the overhead console for each seat belt.



 illuminates in different colours depending on condition:

- red : seat belt not fastened
- green : seat belt fastened
- grey : seat not occupied

- When the ignition is switched on,  illuminates in the overhead console in the corresponding colour.
- After driving off,  in the Driver Information Centre and the symbol for the respective seat in the overhead console flash in red for a certain time together with a chime if the respective seat is occupied but the seat belt is not fastened. After a certain time of driving,  illuminates constantly in red until the seat belt of the respective seat has been fastened.
- If any passenger has unfastened the seat belt during driving,  in the Driver Information Centre and the symbol for the respective seat in the overhead console flash in red for a certain time together with a chime. After a certain time of driving,  illuminates constantly in red until the seat belt of the respective seat has been fastened again.

Depending on version,  could illuminate in red when the respective seat is not occupied or  could extinguish after a certain time independent on condition.

Seat belts ⇨ 38.

Airbag and belt tensioners

 and  illuminate yellow.

When the ignition is switched on, the control indicator illuminates for some seconds. If it does not illuminate, does not extinguish after some seconds or illuminates whilst driving, there is a fault in the airbag system. Seek the assistance of a workshop. The airbags and belt pretensioners may fail to trigger in the event of an accident.

Deployment of the belt pretensioners or airbags is indicated by continuous illumination of .

Warning

Have the cause of the fault remedied immediately by a workshop.

Belt pretensioners ⇨ 38.

Airbag system ⇨ 40.

Airbag deactivation



 illuminates yellow.

The front passenger airbag is activated.

 illuminates yellow.

The front passenger airbag is deactivated.

Airbag deactivation ⇨ 45.

Charging system

 illuminates red.

Illuminates when the ignition is switched on and extinguishes shortly after the engine starts.

Illuminates when the engine is running

Stop, switch off engine. Vehicle battery is not charging. Engine cooling may be interrupted. The brake servo unit may cease to be effective. Seek the assistance of a workshop.

Malfunction indicator light

 illuminates or flashes yellow.

Illuminates when the ignition is switched on and extinguishes shortly after the engine starts.

Illuminates when the engine is running

Fault in the emission control system. The permitted emission limits may be exceeded. Seek the assistance of a workshop immediately.

Flashes when the engine is running

Fault that could lead to catalytic converter damage. Ease up on the accelerator until the flashing stops. Seek the assistance of a workshop immediately.

Service vehicle soon

 illuminates yellow.

Illuminates briefly when the ignition is switched on.

May illuminate together with other control indicators and a corresponding message in the Driver Information Centre.

Seek the assistance of a workshop immediately.

Stop engine

 illuminates red.

Illuminates briefly when the ignition is switched on.

Illuminates together with other control indicators, accompanied by a warning chime and a corresponding message in the Driver Information Centre.

Stop engine immediately and seek the assistance of a workshop.

Hybrid system active

READY illuminates green.

The vehicle is ready to drive. Extinguishes when the vehicle has reached a certain speed.

Hybrid system fault

 illuminates red.

The hybrid system has a fault.

Switch off ignition and seek the assistance of a workshop.

Brake and clutch system

 illuminates red or yellow.

The brake and clutch fluid level is too low.

Warning

Stop. Do not continue your journey. Consult a workshop.

Brake fluid ⇨ 210.

Parking brake

 illuminates or flashes red.

Illuminates

Parking brake is applied ⇨ 143.

Flashes

Electric parking brake is not applied automatically. The application or the release are faulty.

Warning

Have the cause of the fault remedied immediately by a workshop.

Electric parking brake fault

 illuminates yellow.

Illuminates

Electric parking brake has a fault
⇨ 143.

Warning

Have the cause of the fault remedied immediately by a workshop.

Automatic operation of electric parking brake off

 illuminates yellow.

Illuminates

Automatic operation is deactivated or faulty. In the event of a fault,  illuminates together with other control indicators or it is accompanied by a corresponding message in the Driver Information Centre.

Activate automatic operation again or have the cause remedied by a workshop in the event of a fault.

Automatic operation ⇨ 143.

Antilock brake system (ABS)



 illuminates yellow.

Illuminates for a few seconds after the ignition is switched on. The system is ready for operation when the control indicator extinguishes.

If the control indicator does not extinguish after a few seconds, or if it illuminates while driving, there is a fault in the ABS. The brake system remains operational but without ABS regulation.

Antilock brake system ⇨ 143.

Gear shifting

 or  with the number of a higher or lower gear is indicated, when upshifting or downshifting is recommended for fuel saving reasons.

On vehicles with automatic transmission, the system is only active in manual mode.

Manual mode ⇨ 139.

Power steering

 illuminates red or yellow.



The power steering has a fault. Drive carefully at a moderate speed and consult a workshop.

Lane keep assist

 illuminates or flashes yellow.

Illuminates yellow

The system has been automatically deactivated or placed on standby.

If  and  illuminate, the system has a fault. Seek the assistance of a workshop.

Flashes yellow

The system is correcting the unintended lane change.

Lane keep assist ⇨ 177.

Advanced lane keep assist

 illuminates grey, green or yellow.

Illuminates grey

The system is paused. At least one system limitation has been detected.

Illuminates green

The system is active and ready to operate.

Illuminates yellow

The system has a fault.

Advanced lane keep assist ⇨ 179.

Parking assist

 illuminates yellow.

The system is deactivated.



Electronic Stability Control and Traction Control system

 illuminates or flashes yellow.

Illuminates

A fault in the system is present. Continued driving is possible. Driving stability, however, may deteriorate depending on road surface conditions.

Have the cause of the fault remedied by a workshop.

After reconnecting the vehicle battery, (e.g. after maintenance work),  is illuminated for several seconds. After this time period,  extinguishes. This is a normal procedure, the vehicle does not need any assistance.

Flashes

The system is actively engaged. Engine output may be reduced and the vehicle may be braked automatically to a small degree.

Electronic Stability Control and Traction Control system ⇨ 146.

Engine coolant temperature

 illuminates red.

Illuminates red when the engine is running

Stop, switch off engine.

Caution

Coolant temperature too high.

Check coolant level immediately ⇨ 209.

If there is sufficient coolant, consult a workshop.

Preheating

 illuminates yellow.

Preheating of diesel engine is activated. Only activates when outside temperature is low. Start the engine when control indicator extinguishes.

Starting the engine ⇨ 126.

AdBlue

 flashes or illuminates yellow.

Illuminates yellow

The remaining driving range is between 500 miles and 1500 miles.

Flashes yellow

The remaining driving range is between 0 and 500 miles.

AdBlue level is low. Refill AdBlue soon to avoid prevention of the engine start.

AdBlue ⇨ 132.

Deflation detection system

 illuminates or flashes yellow.

Illuminates

Tyre pressure loss in one or more wheels. Stop immediately and check tyre pressure.

Flashes

Fault in system. Consult a workshop.
Deflation detection system ⇨ 218.

Engine oil pressure

 illuminates red.

Illuminates when the ignition is switched on and extinguishes shortly after the engine starts.

Illuminates when the engine is running**Caution**

Engine lubrication may be interrupted. This may result in damage to the engine and / or locking of the drive wheels.

1. Select neutral gear.
2. Move out of the flow of traffic as quickly as possible without impeding other vehicles.
3. Switch off ignition.

Warning

When the engine is off, considerably more force is needed to brake and steer. During an Autostop the brake servo unit will still be operational.

Do not remove key until vehicle is stationary, otherwise the steering wheel lock could engage unexpectedly.

Keep engine turned off and let the vehicle be towed to a workshop.

Low fuel

 illuminates yellow.

Level in fuel tank is too low.

Refuelling ⇨ 195.

Bleeding the diesel fuel system
⇨ 213.

Charging cable connected

 illuminates red.

The vehicle plug of the charging cable is still connected to the charge port. The vehicle cannot be started.

Disconnect the vehicle plug from the charge port and close the charge port flap.

Charging ⇨ 187.

Apply footbrake

 illuminates.

Insufficient or no pressure on the brake pedal. Depress the brake pedal before releasing the parking brake and moving out of **P**.

Autostop

 illuminates or flashes green.

Illuminates green

Engine is in an Autostop.

Flashes green

Autostop is temporarily unavailable, or Autostop mode is invoked automatically.

If  illuminates yellow, the stop-start system is deactivated.

Stop-start system ⇨ 127.

Exterior light

 illuminates green.

The exterior lights are on ⇨ 94.

Low beam

 illuminates green.

Illuminated when low beam is on.

High beam

 illuminates blue.

Illuminates when high beam is on or during headlight flash ⇨ 95.

High beam assist

 illuminates green or yellow.

Illuminates green when the high beam assist is activated ⇨ 95.

Illuminates yellow when a malfunction has been detected. Seek the assistance of a workshop.

Rear fog light

 illuminates yellow.

The rear fog light is on ⇨ 100.

Pedestrian safety alert fault

 illuminates yellow.

The pedestrian safety alert is not working.

Active emergency braking

 illuminates or flashes yellow.

Illuminates

The system has been deactivated or a fault has been detected.

Additionally, a warning message is displayed in the Driver Information Centre.

Check the reason of the deactivation ⇨ 159 and in case of a system fault, seek the assistance of a workshop.

Notice

 also illuminates if the seat belts of the front passengers are not fastened. In this case, active emergency braking is deactivated.

Flashes

The system is actively engaged and brakes automatically the vehicle.

Active emergency braking ⇨ 159.

Door open

 illuminates red.

A door or the tailgate is open.

Displays

Driver Information Centre



In addition to warning lights, gauges and indicators, the following information is available:

- trip odometer
- gear shift indication
- service information
- vehicle and warning messages
- driver assistance messages
- pop-up messages
- infotainment information

Vehicle messages ⇨ 89.

Pages



Press the button to scroll through the pages or to close a pop-up message.

Personalisation

The Driver Information Centre can be personalised via the menu in the Info Display.



Several pages can be created by choosing widgets to be displayed. It is possible to memorise up to five pages with one or two widgets each.

Personalisation ⇨ 107.

Info Display



The Info Display can indicate:

- time ⇨ 71
- outside temperature ⇨ 71
- date ⇨ 71
- Infotainment system ⇨ 103
- navigation ⇨ 110

- vehicle and system messages
↪ 89
- settings for vehicle personalisation ↪ 91

Selecting menus and settings

There are three options to operate the display:

- via buttons below the display
- by touching the touchscreen with the finger
- via the voice assistant

Button and touch operation

Press  to display the menu for the driver assistance systems.

Press  to display the home screen.

Press  to display the climate menu.

Touch required menu display icon or a function with the finger.

Confirm a required function or selection by touching.

Infotainment system ↪ 103.

Personalisation

The Info Display can be personalised via the personalisation menu.

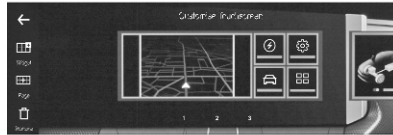

Several pages can be created by choosing widgets to be displayed.

Personalisation ↪ 107.

Powerflow

This menu displays the current energy flow within the hybrid system. The components will be highlighted when they are active.



1. Press .
2. Touch .
3. Select **Energy Flow**.

Different colours show which engine is used and whether energy is regenerated.

- green: regenerating energy
- orange: combustion engine operating
- blue: electric engine operating

Average consumption

This menu displays the average power and fuel consumption during the current trip. The current trip is subdivided into time steps. For each time step, the average consumption is displayed. The time steps can be modified.

1. Press .
2. Touch .
3. Select **Statistics**.
4. Press **+** and **-** to modify the time steps.

Power consumption

The consumption of electrical power is displayed in kWh/100 miles.

- The green graph shows the energy regenerated during deceleration and braking phases to recharge the high voltage battery.
- The blue graph shows the energy consumed directly from the high voltage battery.

Fuel consumption

The orange graph shows the average fuel consumption on the current trip in litre per 100 miles and historical values.



e-SAVE function

This function allows to provide electrical energy of the high voltage battery for a later use, e.g. for driving in areas restricted to electrical vehicles. It is possible to reserve the complete electrical energy of the battery or a part of it.

Notice

If the energy requested exceeds the energy of the high voltage battery, the combustion engine charges the battery. This results in a loss of performance and a higher fuel consumption.

The function can be activated in the Info Display.

1. Press .
2. Touch .
3. Select **e-SAVE**.
4. Select the distance for which electrical is to be reserved or reserve the whole capacity of the high voltage battery.
5. Press ON.
 illuminates in the Driver Information Centre when the function is activated.

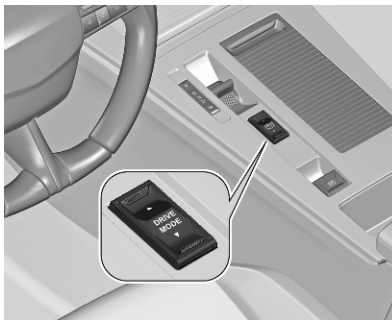

6. To use the reserved electrical energy change to electric mode.

The setting of this function is not stored when the ignition is switched off.

Head-up display

This extended head-up display projects information onto the windscreen in the driver's field of vision so that they do not need to take their eyes off the road.

Notice

The head-up display may not be legible when wearing polarised sunglasses.

Activation

The head-up display can be activated or deactivated via the brightness menu in the settings app  in the Info Display. Also the brightness of the head-up display can be adjusted. Settings menu  104.

Height adjustment

The height of the head-up display can be adjusted via the control in the driver's door.

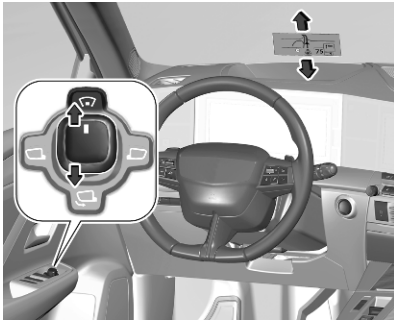

1. Turn the knob to .
2. Push the knob forwards or backwards until the desired height is adjusted.

Personalisation

The content of the head-up display can be chosen via the menu in the Info Display.



One widget can be chosen for the head-up display.

Personalisation  107.

Vehicle messages

Messages are indicated in the Driver Information Centre, in some cases together with a warning chime.



Press to confirm a message.

Vehicle and service messages

The vehicle messages are displayed as text. Follow the instructions given in the messages.

Messages in the Info Display

Some important messages may appear additionally in the Info Display. Some messages only pop-up for a few seconds.

Warning chimes

The warning chime regarding not fastened seat belts has priority over any other warning chime.

Whenever a warning chime sounds, pay attention to the messages displayed and the warning lights in the Driver Information Centre.

When starting the engine or whilst driving

A warning chime will sound in situations such as

- a seat belt is not fastened
- a door or the tailgate is not fully closed
- a certain speed is exceeded with parking brake applied
- cruise control deactivates automatically

If several warnings appear at the same time, only one warning chime will sound.

When the vehicle is parked and / or the driver's door is opened

- With exterior lights on.

During an Autostop

- If the driver's door is opened.
- If any condition for a restart of the engine is not fulfilled.

Trip computer

The trip computer displays current trip information since the last reset.



Pressing the button displays the following tabs in turn:

- current information
 - total range (petrol or diesel vehicle)
 - current consumption (petrol or diesel vehicle)
 - time counter for the stop-start mode (petrol or diesel vehicle)

- percentage of the current journey travelled in all-electric driving mode (hybrid vehicle)
- total distance recorder (hybrid vehicle)
- trip 1
 - average speed
 - average fuel consumption
 - distance travelled
- trip 2
 - average speed
 - average fuel consumption
 - distance travelled

The time counter is reset each time the ignition is switched on.

To reset a trip, press the button for more than two seconds when the desired trip is displayed.

Vehicle personalisation

The vehicle's behaviour can be personalised by changing the settings in the Info Display.

Some functions are only displayed or active when the engine is running.



Driver assistance systems



To display the settings of the advanced driver assistance systems, press .

A shortcut for each driver assistance system can be created by touching . All driver assistance systems with

a shortcut will be displayed in the shortcut tab for fast activation or deactivation.

Vehicle settings

The vehicle settings can be displayed via the home screen:

- Press  to display the home screen.
- If necessary, touch  and swipe the screen downwards and touch .
- Touch the vehicle settings menu on the left side.

Telematics services

Emergency call

Notice

In order to be available and operational, the system requires functioning vehicle electrics, mobile service and GPS or GLONASS satellite link. Depending on equipment, a backup battery is used.

Notice

The service is only available for markets where it is legally required. Furthermore, it depends on the availability of the emergency centres and the infrastructure in the country.

Status LED in the overhead console

Illuminates green and red and extinguishes after a short time, when the ignition is switched on: the system works properly.

Illuminates red: fault in the system. Contact a workshop.

Flashes red: backup battery needs replacement. Contact a workshop.

Emergency call

The emergency call function will establish a connection to the nearest public safety answering point (PSAP). A minimum set of data including vehicle and location information will be sent to the PSAP.

In case of an emergency, press the red **SOS** button in the overhead console for more than two seconds. The LED flashes green to confirm that a connection to the nearest PSAP is being established. The LED illuminates steadily as long as the call is active.

Pressing the **SOS** button immediately a second time will terminate the call. The LED switches off.

Automatic crash notification

In case of an accident with airbag deployment and without damage of needed hardware, an automatic emergency call is established and an automatic crash notification will be transmitted to the next PSAP.

Vauxhall Connect

Vauxhall Connect comprises multiple connected services accessible via app, online or within the vehicle.

Notice

Full functionality of Vauxhall Connect is subject to registration and proper activation.

Connected services may include live navigation such as online traffic information and vehicle status and information such as maintenance alerts.

Services accessible within the vehicle also include emergency call and breakdown call. These functions are automatically activated. Terms and conditions apply.

Emergency call ⇨ 92.

Breakdown call

Pressing the  button in the overhead console for more than two seconds connects to a roadside assistance service provider.

For information about coverage and scope of services of the roadside assistance, please refer to the Service and warranty booklet.

Privacy settings

Privacy settings of Vauxhall Connect can be configured. This will impact the set of data being sent, e.g., in case a breakdown call is triggered. The emergency call function will not be impacted.

Depending on version, the privacy settings can be changed by simultaneously pressing  and **SOS** in the overhead console or via the system settings menu in the Info Display.

Lighting

Exterior lighting	94
Light switch	94
Automatic light control	95
High beam	95
High beam assist	95
Headlight flash	96
Headlight range adjustment	96
Headlights when driving	
abroad	96
Daytime running lights	96
Matrix-LED headlights	96
Hazard warning flashers	99
Turn lights	99
Front fog lights	99
Rear fog light	100
Parking lights	100
Reversing lights	100
Misted light covers	101
Interior lighting	101
Instrument panel illumination	
control	101
Interior lights	101
Reading lights	101
Sunvisor lights	101

Lighting features	102
Centre console lighting	102
Entry lighting	102
Exit lighting	102
Vehicle locator lighting	102
Battery discharge protection	102

Exterior lighting

Light switch



Turn adjuster wheel:

- AUTO** : automatic light control
switches automatically
between daytime running
light and headlight
- ☞☞ : sidelights
- ☞D : low beam / high beam

Control indicator ☞☞ ⇨ 85.

Automatic light control



When the automatic light control function is switched on, the system switches between daytime running lights and headlights automatically depending on the external lighting conditions and information given by the wiper system.

Daytime running light ↷ 96.

Automatic headlight activation

Turn the adjuster wheel in position: **AUTO**

During poor lighting conditions the headlights are switched on.

Additionally, headlights are switched on if the windscreen wipers have been activated for several wipes.

High beam



To activate or deactivate the high beam, pull the lever beyond the resistance point.

High beam assist

The system switches from low beam to high beam and vice versa to prevent glaring. Once activated, high beam assist remains active and switches high beam on and off depending on surrounding

conditions. The latest setting of the high beam assist will remain set after the ignition is switched on again.



Glare-free high beam for Matrix-LED headlights ↷ 96.

Activation

The high beam assist can be activated via the vehicle settings menu in the Info Display.

Info Display ↷ 86.

High beam is switched on automatically in dark surroundings at a speed above 28 mph. High beam is switched off at a speed below 22 mph, but high beam assist remains active.

The green control indicator  illuminates continuously when the high beam assist is activated, the blue  illuminates when high beam is on.

Control indicator  ↷ 85,  ↷ 85.

High beam assist switches automatically to low beam when:

- Driving in urban areas.
- Camera detects heavy fog.

- Rear fog light is switched on.
- Oncoming or preceding vehicles are detected by the camera.

If there are no restrictions detected, the system switches back to high beam.

Deactivation

The system can be deactivated via the vehicle settings menu in the Info Display.

Info Display ⇨ 86.

Headlight flash



To activate the headlight flash, pull the lever briefly without passing the resistance point.

Headlight range adjustment

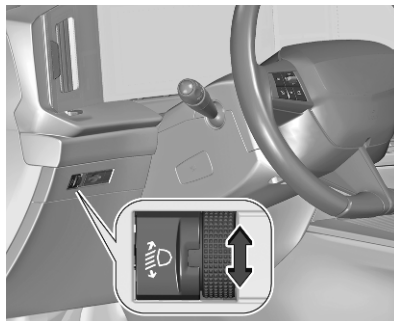

To adapt headlight range manually to the vehicle load to prevent dazzling, turn thumb wheel  to required position.

- 0 : front seats occupied
- 1 : all seats occupied
- 2 : all seats occupied and load compartment laden
- 3 : driver's seat occupied and load compartment laden

Headlights when driving abroad

When driving in countries where traffic drives on the opposite side of the road, the headlights do not have to be adjusted.

Daytime running lights

Daytime running lights increase visibility of the vehicle during daylight. Automatic light control ⇨ 95.

Matrix-LED headlights

The Matrix-LED headlight system contains a variety of particular LEDs in each headlight which enables the control of the adaptive forward lighting functions.

Light distribution and intensity of light are variably triggered depending on the lighting conditions, road type and driving situation. The vehicle adapts the headlights automatically to the situation to enable optimal light performance for the driver.

The adaptive forward lighting and the Matrix-LED headlights functions can be deactivated or activated in the vehicle personalisation menu.

Vehicle personalisation ⇨ 91.

Info Display ⇨ 86.

The glare-free high beam function of the Matrix-LED headlights are only available with light switch in position **AUTO**.

Country light

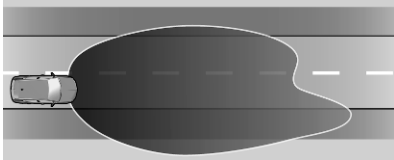

Activated automatically with vehicle speed when driving in rural areas. The illumination of the current lane and the side of the road is adapted. Oncoming and preceding vehicles are not dazzled.

Town light

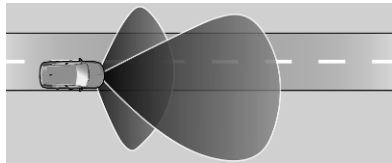

Activated automatically at a speed up to approx. 30 mph. The light is wide and symmetrical.

Adverse weather light

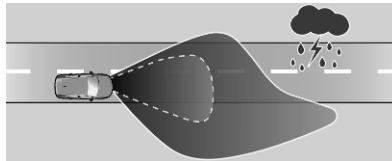

If bad weather conditions are detected, low beam is dimmed to avoid dazzling the oncoming traffic.

Cornering light

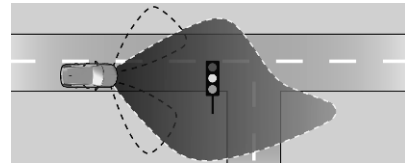

Particular LEDs, based on direction of travel, are additionally triggered to improve lighting. This function is activated at a speed up to 25 mph when turning off.

Curve light

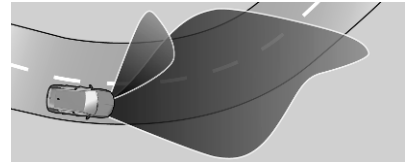

Particular LEDs, based on steering angle and speed, are additionally triggered to improve lighting in curves. This function is activated at speeds from 25 mph to 43 mph.

Reverse parking function

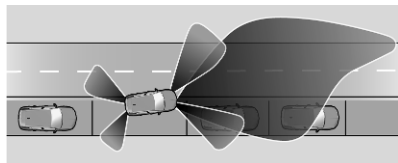

To assist driver's orientation when parking, cornering lights and reversing light illuminate when headlights are activated and reverse gear is engaged. Cornering light and reversing light remain illuminated for a short time after disengaging the reverse gear, or when accelerating to a speed above approx. 6 mph.

Eco mode

During an Autostop the headlight functions are reduced to save power.

Glare-free high beam

⚠ Warning

The glare-free high beam function may dazzle other road users when the vehicle is driven in countries

where traffic moves on the opposite side of the road. E.g. when the vehicle was designed for left hand drive traffic and it is driven in a country with right hand drive traffic.

Switch off glare-free high beam function whenever you are driving in countries mentioned above!

The system enables a glare-free high beam when driving in dark surroundings.

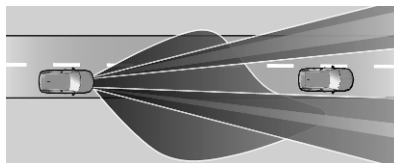

Each LED on right or left side is triggered or faded out particularly according to the traffic situation. This gives the best light distribution without dazzling other road users.

Glare-free high beam is switched on automatically at a speed above 28 mph. It is switched off at a speed below 22 mph, but the system remains active.

Motorway mode

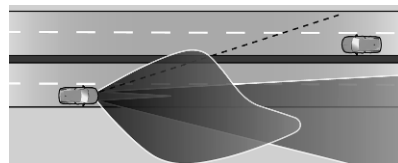

Activated automatically at a speed above 65 mph. Illumination is adapted to the higher speed driven on motorways. If there is oncoming traffic, following vehicles ahead or passing, the illumination on the side of the vehicle is reduced.

Fault in LED headlight system

When the system detects a failure in the LED headlight system, it selects a preset position to avoid dazzling of oncoming traffic. A warning is displayed in the Driver Information Centre.

Hazard warning flashers

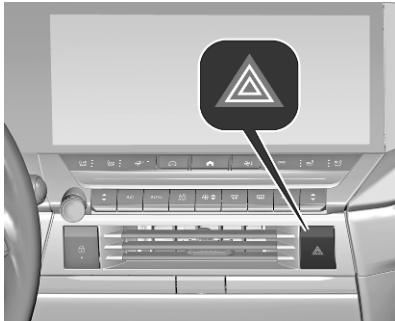

Operated by pressing .

When braking in an emergency, the hazard warning flashers are switched on automatically, depending on the force of deceleration. They are switched off automatically, as soon as the vehicle is accelerated again.

Turn lights

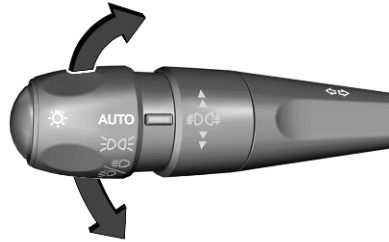

up : right turn lights
down : left turn lights

A resistance point can be felt when moving the indicator lever.

Constant flashing is activated when the indicator lever is being moved beyond the resistance point. It is deactivated when the steering wheel is moved in the opposite direction or indicator lever is manually moved back to its neutral position.

After 20 seconds the volume of the audible signal will increase if the speed is above 50 mph.

Activate temporary flashing by holding the indicator lever just before the resistance point. Turn lights will flash until indicator lever is being released.

To activate three flashes, tap the indicator lever briefly without passing the resistance point.

Front fog lights



Turn the adjuster wheel forwards / backwards to switch on / off.

Light switch in position **AUTO**: switching on front fog lights will switch headlights on automatically.

Rear fog light

Depending on version:



Turn the adjuster wheel forwards / backwards to switch on / off.



Turn the adjuster wheel forwards / backwards to switch on / off the front fog light.

Turn the adjuster wheel two times forwards / backwards to switch on / off the rear fog light.

Light switch in position **AUTO**: switching on rear fog light will switch headlights on automatically.

Light switch in position : rear fog light can only be switched on with front fog lights.

The vehicle rear fog light is deactivated when towing a trailer or a plug is connected with the socket, e.g. when a bicycle carrier is used.

Parking lights

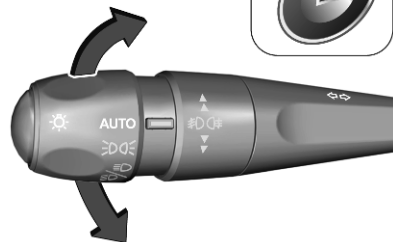

When the vehicle is parked, the parking lights on one side can be activated:

1. Switch off ignition.
2. Move the lever all the way up (right parking lights) or down (left parking lights).

Confirmed by a signal and the corresponding turn lights control indicator.

Reversing lights

The reversing light comes on when reverse gear is selected.

Misted light covers

The inside of the light housing may mist up briefly in poor, wet and cold weather conditions, in heavy rain or after washing. The mist disappears quickly by itself. To help, switch on the headlights.

Interior lighting

Instrument panel illumination control

Brightness of the following lights can be adjusted in the vehicle personalisation on the Info Display, when the exterior lights are on:

- instrument panel illumination
- Info Display
- illuminated switches and operation elements

➔ 91

Interior lights



Operated by pressing ☀.

Notice

In the event of an accident with airbag deployment the courtesy lights are turned on automatically.

Reading lights

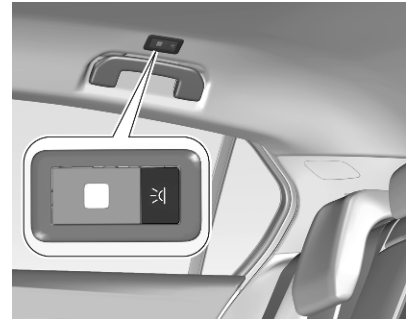

Operated by pressing ☞.

Depending on version, the location of the reading lights is different.

Sunvisor lights

Illuminates when the cover is opened.

Lighting features

Centre console lighting

A spotlight integrated in the overhead console illuminates the centre console when headlights are switched on.

Entry lighting

Welcome lighting

Some or all of the following lights are switched on for a short time by unlocking the vehicle with the radio remote control:

- headlights
- interior lights
- turn lights
- number plate lights

The number of activated lights depends on the surrounding light conditions.

The lighting switches off immediately when the ignition is switched on.

Starting off ⇨ 124.

This function can be activated or deactivated in the vehicle personalisation.

Vehicle personalisation ⇨ 91.

The following lights will additionally switch on when the driver's door is opened:

- illumination of some switches
- Driver Information Centre
- door pocket lights

Exit lighting

The following lights are switched on when the ignition is switched off:

- headlights
- interior lights
- centre console lighting

They will switch off automatically after a delay. This function works only in the dark.

Vehicle locator lighting

This function allows to locate the vehicle, e.g., in weak lighting conditions using the remote control. The headlights come on and the turn lights flash for ten seconds.

Press  two times on the remote control.

Battery discharge protection

To prevent discharge of the vehicle battery when the ignition is switched off, some interior lights are switched off automatically after some time.

Infotainment system

Introduction	103
Control elements overview	103
Basic operation	104
Personalisation	107
Profiles	108
Audio	109
Navigation	110
Navigation system	110
Voice assistant	111
Phone	111
Bluetooth connection	111
Using smartphone applications	112
Mobile phones and CB radio equipment	112

Introduction

Important information on operation and traffic safety

⚠ Warning

The Infotainment system must be used so that the vehicle can be driven safely at all times. If in doubt, stop the vehicle and operate the Infotainment system while the vehicle is stationary.

Radio reception

Radio reception may be disrupted by static, noise, distortion or loss of reception due to:

- changes in distance from the transmitter
- multipath reception due to reflection
- shadowing

Control elements overview

Control panel



- ⏻ : Short press: switch the system on / off or mute the sound.
Long press: switch to standby mode.
- 🔊 : Rotate: adjust the volume.
- 🚗 : Display the menu for the driver assistant systems.
- 🏠 : Display the home screen.
- 📶 : Display the menu for the climate settings.

Steering wheel controls

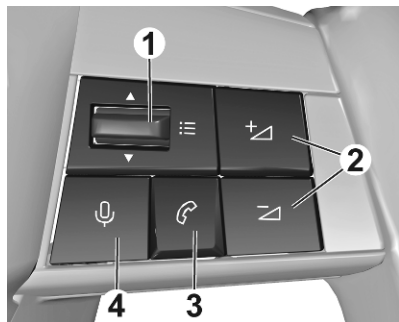

1 : Toggle up or down: select the previous / next radio station or track or browse through the list of recent calls.

Short press: display a menu or validate a selection.

2 : Short press: adjust the volume or unmute the sound.

Long press on : mute the sound.

3 : Short press: accept an incoming call, hang up, display the list of recent calls or display the phone projection screen.

Long press: refuse an incoming call.

4 : Short press: activate the voice assistant of the Infotainment system.

Long press: activate the voice assistant of the connected mobile phone.

Basic operation

Screen operations

The display of the Infotainment system has a touch-sensitive surface that allows direct interaction with the displayed menu controls.

Caution

Do not use pointed or hard items like ballpoint pens, pencils or similar for touchscreen operation.

Use the following finger gestures to control the Infotainment system.

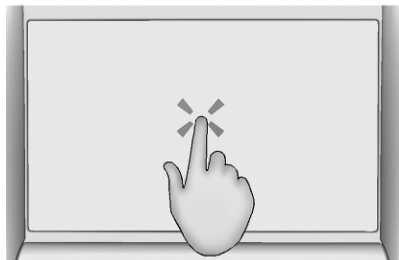
Touch

Touch is used to open a menu or select an option.

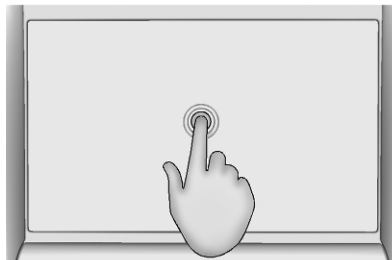
Touch and hold

Touch and hold can be used to save radio stations.

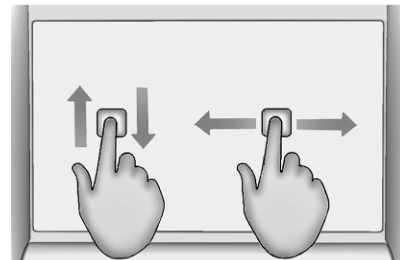
Swipe

Swipe is used to scroll through a menu or to pan the map.

Returning to the previous screen in a submenu

To return to the previous screen, touch ← in the upper part of the screen.

Displaying and hiding the menu

Within an app, the menu can be displayed and hidden by touching ☰.

Status bar

The status bar is the top bar on the screen. It can indicate the following:

- time
- outside temperature
- Wi-Fi connection status
- Bluetooth activation
- mobile reception
- activated functions, e.g. heated steering wheel



Apps overview



To display a list of all available apps, touch .

Alternatively, the apps overview will be displayed by a 3-finger touch on the screen.

System settings

To display the system settings menu, open the settings app  and touch the menu for the system settings .



The following system settings can be adjusted:

- language
- date and time, time format, date format
- unit for distance and consumption
- unit for outside temperature
- restore the factory settings
- view system information

Brightness

To adjust the brightness of the instrument panel illumination, the interior lighting and the head-up

display, open the settings app  and touch the menu for the brightness adjustment.

The interior lighting and the head-up display can also be activated or deactivated.

Connectivity

To display the connectivity menu, open the settings app  and touch the menu for connectivity.

The following settings are adjustable:

- wireless devices: display all paired devices, connect or disconnect a device, choose the connection preferences for each device (Bluetooth or phone projection) and search for nearby devices
- Wi-Fi networks: activate or deactivate Wi-Fi, search for nearby Wi-Fi networks and connect the system to a Wi-Fi network
- privacy settings: activate or deactivate data and location sharing for authorised services

System updates

When an update is available and ready to install, a message will be displayed at the end of a trip after stopping the vehicle.

Alternatively, open the settings app  and touch the menu for updates to check if an update is available. If available, pending updates will be displayed on the screen.

It is possible to activate automatic downloads of updates by touching the checkbox. If activated, the updates will be automatically downloaded when the vehicle is connected to an external Wi-Fi network.

The installation of an update will continue even if the vehicle will be left and closed. When the vehicle has started again, a message will be displayed on the screen if the installation of the update has been successfully finished.

When the installation has been failed, a corresponding message will be displayed on the screen. Contact an assistance centre.

Connected services

To display the menu for connected services, open the settings app  and touch the corresponding menu entry.

Personalisation

The Driver Information Centre, the head-up display and the Info Display can be personalised.

To display the personalisation menu, open the settings application  and touch the menu for customisation.

Screen colour

The background colour of the Driver Information Centre and the Info Display can be chosen. The chosen background colour will immediately be shown in both the Driver Information Centre and the Info Display.

Interior colour

The colour of interior lighting features, e.g. the light on the door handles, can be chosen.

Sound ambience

An active sport sound for the sport mode can be activated or deactivated.

Animations

Exterior and interior animations to welcome and say good bye to the driver can be activated or deactivated.

Pages

Several personalised pages for the Driver Information Centre and the Info Display can be created. The head-up display belongs to the Driver Information Centre page.

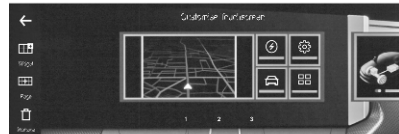

Each page can be personalised by choosing the widgets to be displayed.

To add a page, touch .

To delete a page, touch .

Widgets

A widget is the indication of specific information or gauge, e.g. radio information, navigation information or the engine coolant temperature gauge.



The Driver Information Centre can display two widgets and the head-up display can display one widget. The Info Display can contain several widgets.

To add a widget to a page, touch .

Some widgets are available in different sizes. The bigger a widget is, the less widgets can be displayed on a page.

Profiles

Several user profiles can be created.

Due to the option of creating profiles, the Infotainment system can be fitted to several drivers. Different settings as well as saved radio stations and destinations will be connected to a specific profile. Thereby, the settings don't need to be adjusted every time another person is driving the vehicle.

To display the profile settings, open the settings app  and touch the profile menu.

Creating a profile



To create a new profile, touch .

The following settings can be adjusted for each profile:

- profile name
- avatar
- associated device

Once a new profile is created, the profile settings can be changed at any time by touching .

Deleting a profile

To delete a profile, touch  next to the corresponding profile and select . The guest profile cannot be deleted.

The guest profile is a default profile. It is active when no other profile is created or active.

Audio

Open the audio app to display the audio screen.

Touch  to display the audio main screen.

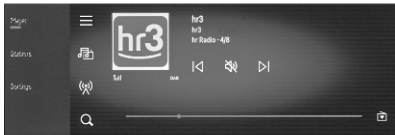

Switching the radio stations

Touch  briefly to perform an automatic search for the next radio station.

Touch and hold  to perform a quick search for the next radio stations.

Touch  briefly to perform an automatic search for the previous radio station.

Touch and hold  to perform a quick search for the previous radio stations.

Station list

All available radio stations will be displayed as a list by touching the list entry in the radio menu on the left side of the screen.

Waveband

To select the waveband, touch .

Frequency tuning

To tune into a specific radio frequency, touch .

A number pad will be displayed. Enter the desired frequency and touch  to confirm.

Saving radio stations

Saved radio stations will be displayed or hidden by touching . The saved radio stations will be lined up in the lower part of the screen. Touch the desired radio station to tune in.

To save the current radio station, touch and hold the desired button. Buttons which are already used for

radio stations can be overwritten. Unused buttons for saving radio stations will be indicated by .

Alternatively, radio stations can be saved by touching the corresponding heart icon in the station list.

Mute

To mute or unmute, touch .

Audio settings

In the settings menu within the radio app, the following settings can be adjusted:

- sound settings: ambience sound, equaliser, treble
- radio settings: station list order, activation or deactivation of station follow-up and traffic and news announcements
- volume settings: system voice, ringtone, phone call, system sounds

Navigation

Navigation system

Touch  in the Info Display to open the navigation app.

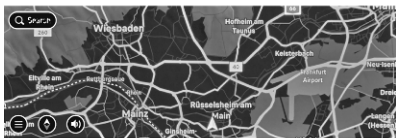

Starting a route guidance

To start a route guidance, touch  to enter an address via a keyboard.

After typing the first letters of the address, matching addresses will be displayed.

Once the address is entered, several routes might be displayed on the map. Choose one before starting the route guidance.

Active route guidance

During an active route guidance, information about the route, e.g. the estimated arrival time and the distance, will be displayed on the screen.

To activate or deactivate voice prompts of the route guidance, touch .

To change the route, add a stop, e.g. a restaurant or a petrol station, or to show instructions, touch the three points on the side bar of the screen.

Route settings

To open the settings menu, touch the three points on the side bar of the screen and then touch the settings menu .

Touch  to view map downloads, to set the map colour, to set the points of interest shown on the map and other map settings, to set the arrival information, to set the side bar on the route guidance screen, to set the map orientation or to show the vehicle range on the map.

Touch  to set the options for rerouting, to set the preferred route types (fast, short, eco-friendly) or to avoid specific routes (toll roads, unpaved roads, etc.).

Touch  to set the types of voice prompts, alerts and sounds.

Touch  to set the privacy information (keep journey history, frequent destinations, etc.).

Map updates



When connected services are activated, the map will be updated automatically.



Connected services  104.

Voice assistant

The integrated voice assistant can be used to operate the Infotainment system via voice commands.

There are three ways to activate the voice assistant:

- press  on the steering wheel
- touch  in the Info Display
- say "Hey Vauxhall"

After pressing  on the steering wheel or touching  in the Info Display, wait for the beep before saying a voice command.

To display some voice command examples, open the help menu  in the Info Display. The examples will be sorted by categories, e.g. radio or navigation.

Phone

Bluetooth connection

Touch  in the Info Display to open the phone app.

Once a mobile phone is connected to the Infotainment system via Bluetooth, the following functions are available via the phone app:

- display the contact list
- display a list of the recent calls
- dial a telephone number via a keyboard

Pairing a mobile phone

To pair a mobile phone, open the settings menu in the phone app in the Info Display.

Once the mobile phone is successfully paired, it will be connected automatically and shown as connected.

Also a second mobile phone can be connected via the settings menu in the phone app.

Making a call

To make a call, choose one of the contacts from the contact list, dial a telephone number via the keyboard or select a number from the recent calls list.

Receiving a call

An incoming call is announced by a ring and a message on the Info Display.

To accept an incoming call or hang up an active call, touch the corresponding button on the Info Display or press  on the steering wheel.

To refuse an incoming call, touch the corresponding button on the Info Display or press and hold  on the steering wheel.

Using smartphone applications

Phone projection

The phone projection applications Apple CarPlay and Android Auto display selected apps from a smartphone on the Info Display and allow their operation directly via the Infotainment controls.

Check with the device's manufacturer if this function is compatible with the smartphone and if this application is available in the country you are in.

Preparing the smartphone

iPhone®: Make sure Siri® is activated on your phone.

Android phone: Download the Android Auto app to your phone from the Google Play™ Store.

Connecting the smartphone

Connect the phone to the USB port ↗ 71 or connect the phone via Bluetooth.

Make sure phone projection is activated in the connectivity settings ↗ 104.

Starting phone projection

Touch the Apple CarPlay or Android Auto app on the Info Display.

The phone projection screen displayed depends on the smartphone and software version.

Using the voice assistant of the smartphone

Press and hold  on the steering wheel and say the corresponding activation voice command of the smartphone's voice assistant to use the voice assistant of the smartphone via the Infotainment system.

Mobile phones and CB radio equipment

Installation instructions and operating guidelines

The vehicle specific installation instructions and the operating guidelines of the mobile phone and hands-free manufacturer must be

observed when installing and operating a mobile telephone. Failure to do so could invalidate the vehicle type approval (EU directive 95/54/EC).

Recommendations for fault-free operation:

- Professionally installed exterior antenna to obtain the maximum range possible.
- Maximum transmission power 10 W.
- Installation of the phone in a suitable spot, consider the area in which the airbag inflates ↗ 43.

Seek advice on predetermined installation points for the external antenna or equipment holder and ways of using devices with a transmission power exceeding 10 W.

Use of a hands-free attachment without external antenna with mobile telephone standards GSM 900/1800/1900 and UMTS is only permitted if the maximum transmission power of the mobile telephone is 2 W for GSM 900 or 1 W for the other types.

For reasons of safety, do not use the phone while driving. Even use of a hands-free set can be a distraction while driving.

⚠ Warning

Operation of radio equipment and mobile telephones which fail to meet above mentioned mobile telephone standards is only permitted using an antenna located outside of the vehicle.

Caution

Mobile telephones and radio equipment may lead to malfunctions in the vehicle electronics when operated inside the vehicle with no exterior antenna, unless the above mentioned regulations are observed.

Climate control

Climate control systems	114
Electronic climate control system	114
Auxiliary heater	118
Temperature preconditioning ..	118
Air vents	119
Adjustable air vents	119
Fixed air vents	120
Maintenance	120
Air intake	120
Air conditioning regular operation	121
Service	121

Climate control systems

Electronic climate control system



Single-zone climate control.



Dual-zone climate control.

The dual zone climate control allows different temperatures for driver side and front passenger side.

Controls for:

- temperature ⬆️⬆️
- cooling **A/C**
- automatic mode **AUTO**

- maximum cooling **A/C Max**
- fan speed ⚙️⬆️
- demisting and defrosting 🌬️
- heated rear window and exterior mirrors 🌡️
- manual air recirculation 🚗

Heated rear window 🌡️ ⇨ 27.

Heated exterior mirrors 🌡️ ⇨ 24.

Heated windscreen 🌡️ ⇨ 28.

Heated seats 🌡️ ⇨ 36.

In automatic mode, temperature, fan speed and air distribution are regulated automatically.

Activated functions are indicated in the status bar on the Info Display or with LEDs in the buttons.

The electronic climate control system is only fully operational when the engine is running.

Climate control settings menu

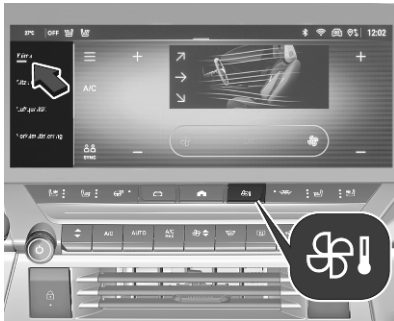

Press  to open the climate settings on the Info Display.

Info Display ⇨ 86.

Automatic mode AUTO

Basic setting for maximum comfort:

- Preselect temperature.
- Press **AUTO**, the air distribution and fan speed are regulated automatically.

Three different pre-set fan speeds can be selected by repeatedly tapping on **AUTO** either on the climate control

panel or on the Info Display: soft, normal or fast. The selected setting is shown on the Info Display.

- Open all air vents to allow optimised air distribution in automatic mode.
- Air conditioning must be activated for optimal cooling and demisting. Press **A/C** to switch on air conditioning. Activation is indicated in the status bar on the Info Display or by the LED in the button.

Temperature preselection

Set the preselected temperature on the Info Display or by using  on the climate control panel. The preselected temperature is indicated in the status bar on the Info Display.

Dual zone climate control: Set the preselected temperatures separately for driver and front passenger to the desired value on the Info Display or by using the left and right buttons on the climate control panel. The button on the passenger side changes the temperature for the passenger side.

The button on the driver's side changes the temperature for the driver's side or for both sides depending on activation of synchronisation **SYNC**.

Recommended temperature is 22 °C.

If the minimum temperature is set, the climate control system runs at maximum cooling.

If the maximum temperature is set, the climate control system runs at maximum heating.

Notice

If **A/C** is switched on, reducing the set cabin temperature can cause the engine to restart from an Autostop or inhibit an Autostop.

Stop-start system ⇨ 127.

Dual zone temperature synchronisation SYNC

Touch **SYNC** in the climate control settings on the Info Display to activate / deactivate synchronisation of the passenger side temperature setting to the driver side temperature setting. Activation of synchronisation is indicated in the status bar on the Info Display.

Manual settings

Climate control system settings can be changed by activating the following functions:

Air conditioning A/C

Press **A/C** to switch on cooling.

Cooling is only functional when the engine is running and cooling fan is switched on. Activation is indicated in the status bar on the Info Display.

Press **A/C** again to switch off cooling.

The air conditioning system cools and dehumidifies (dries) when outside temperature is above a specific level. Therefore, condensation may form and drip from under the vehicle.

If no cooling or drying is required, switch off the cooling system for fuel saving reasons.

A/C Max

Activate maximum cooling with one push of a button.

The **A/C Max** function sets temperature as low as possible and adjusts distribution to all air vents. In addition, it sets air flow to maximum and activates air recirculation.

Notice

If the climate control is set to maximum cooling while the ambient temperature is high, an Autostop may be inhibited until the required temperature in the passenger compartment has been reached.

If the climate control is set to maximum cooling while the engine is in an Autostop, the engine may restart automatically.

Fan speed

Adjust the air flow by pushing  up or down to the desired speed.

Set speed to the lowest level: fan and cooling are switched off.

Fan speed is indicated in the status bar on the Info Display.

To return to automatic mode, press **AUTO**.

Air distribution



Press  to open the climate settings on the Info Display.



Select climate control options from the menu on the left side of the screen and set the desired air distribution along with fan speed and temperature.

Settings are indicated in the status bar on the Info Display.

To return to automatic air distribution, press **AUTO**.

Demisting and defrosting the windows

- Press . Activation is indicated in the status bar on the Info Display.
- Temperature and air distribution are set automatically and the fan runs at high speed.
- Switch on air conditioning by pressing **A/C**, if required.
- Switch on heated rear window .



- Switch on heated windscreen .
- To return to previous mode, press  again. To return to automatic mode, press **AUTO**.

Heated rear window ⇨ 27.

Heated exterior mirrors ⇨ 24.

Heated windscreen ⇨ 28.

Notice

If  is pressed while the engine is running, an Autostop will be inhibited until  is pressed again.

If  is pressed while the engine is in an Autostop, the engine will restart automatically.

Stop-start system ⇨ 127.

Manual air recirculation

Press  to activate the air recirculation mode. Activation is indicated by the LED in the button.



Press  again to deactivate recirculation mode.

Warning

The exchange of fresh air is reduced in air recirculation mode. In operation without cooling, the air humidity increases, so the windows may mist up from inside. The quality of the passenger compartment air deteriorates, which may cause the occupants to feel drowsy.

In warm and very humid ambient air conditions, the windscreen may mist up from outside, when cold air is directed towards it. If windscreen mists up from outside, activate windscreen wiper and deactivate air flow to the front.

Deactivation of electronic climate control system

Push down  subsequently or push down and hold  until the electronic climate control system is deactivated. Deactivation is also possible in the climate settings menu on the Info Display.

Activation by pressing **AUTO**, switching on the fan or switching on any other climate control function.

Air quality

The system combines a high efficiency interior air filter with an air quality sensor and a particle sensor in the control console.



Select **Air Quality** from the menu on the left side of the screen to show the air quality index and to activate / deactivate the function.

Air quality index

Using an exterior pollution sensor, this function automatically activates the air recirculation when a certain level of pollution in the exterior air is detected. When the air quality returns to a satisfactory level, air recirculation is automatically deactivated. Air recirculation is automatically activated when the windscreen washer is used or when reverse gear is engaged. The function is inactive if the outside temperature is below 5° C to prevent the windscreen and side windows of misting up.

Clean air function

The particle sensor in the control console monitors the interior air quality. Air recirculation is automatically managed to enable the interior air being purified by filtering it through the high efficiency filter. If the air quality appears to be reduced permanently, contact a qualified workshop to change the high efficiency filter.

Auxiliary heater

Air heater

Quickheat is an electric auxiliary air heater which automatically warms up the passenger compartment more quickly.

Temperature preconditioning

Temperature preconditioning allows to heat or to ventilate the vehicle's interior to reach an automatically pre-defined temperature. Days and times of temperature preconditioning can be programmed.

The temperature preconditioning can be programmed via the Info Display or the MyVauxhall App.

Notice

The temperature preconditioning is only activated if the ignition is off and the vehicle is locked.

If the charging level of the high voltage battery is below 50%, the temperature preconditioning is not activated.

If a recurrent heating / ventilation is programmed and two heating / ventilation procedures are carried out without operating the vehicle, the programming is deactivated.

Setting timer

Notice

Several timers can be programmed and saved. It is recommended to programme temperature preconditioning with the vehicle plugged in, in order to optimise the long-term performance of the high voltage battery.



Press  to open climate settings on the Info Display.

Select preconditioning settings from the menu on the left side of the screen.

Select **+** to define a new timer or touch  next to a timer to edit it.

Set time and days and confirm.

Activate the timer.

To delete a timer, select the desired timer and press  at the lower left corner of the screen.

The heating / ventilation procedure starts approx. 45 minutes before the programmed time when the vehicle is plugged in, or 20 minutes before the programmed time when it is not plugged in, and is maintained ten minutes after it.

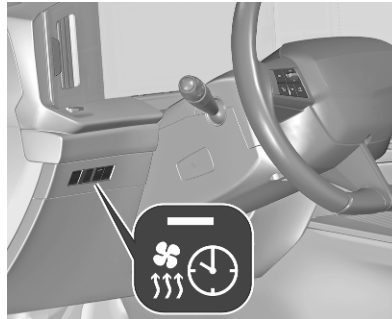

The LED on  shows the operating status of the temperature preconditioning:

- LED illuminates: A timer has been set and activated.
- LED flashes: The system is operating.

The LED extinguishes at the end of the heating / ventilation operation or when the temperature preconditioning is stopped using the remote control.

Air vents

Adjustable air vents

Centre air vents in the instrument panel

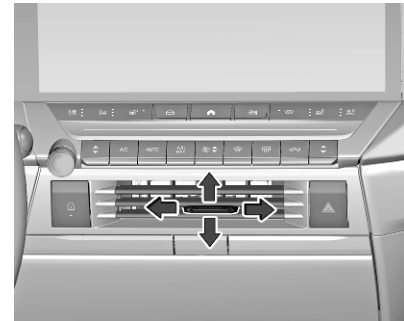

Direct the flow of air by tilting and swivelling the slats.

To close the vent, swivel the slats to the left.

Outer air vents in the instrument panel



Direct the flow of air by tilting and swivelling the slats.

To close the vent, swivel the slats to the left.

At least two air vents must be open while cooling is on.

Warning

Do not attach any objects to the slats of the air vents. Risk of damage and injury in case of an accident.

Air vents for rear passenger

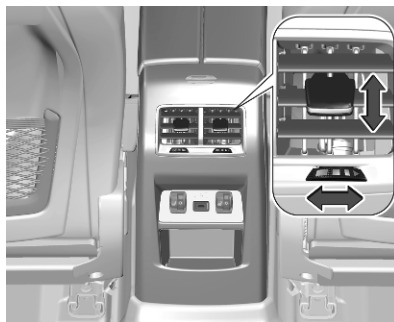

Direct the flow of air by tilting and swivelling the slats.

Close the vent by turning the wheel.

Fixed air vents

Additional air vents are located beneath the windscreen and door windows and in the foot wells.

Maintenance

Air intake



The air intake in front of the windscreen in the engine compartment must be kept clear to allow air intake. Remove any leaves, dirt or snow.

Air conditioning regular operation

In order to ensure continuously efficient performance, cooling must be operated for a few minutes once a month, irrespective of the weather and time of year. Operation with cooling is not possible when the outside temperature is too low.

Service

For optimal cooling performance, it is recommended to annually check the climate control system, starting three years after initial vehicle registration, including:

- functionality and pressure test
- heating functionality
- leakage check
- check of drive belts
- cleaning of condenser and evaporator drainage
- performance check

Driving and operating

Driving hints	123
Control of the vehicle	123
Steering	123
Emergencies	123
Starting and operating	124
New vehicle running-in	124
Ignition switch positions	124
Power button	124
Starting the engine	126
Overrun cut-off	127
Stop-start system	127
Parking	130
Engine exhaust	131
Exhaust filter	131
Catalytic converter	131
AdBlue	132
Automatic transmission electrified	135
Automatic transmission	137
Transmission display	137
Gear selection	138
Manual mode	139
Electronic driving programmes	140

Fault	140
Interruption of power supply	140
Manual transmission	141
Drive systems	141
Drive modes	141
Brakes	143
Antilock brake system	143
Parking brake	143
Brake assist	145
Hill start assist	146
Regenerative braking	146
Ride control systems	146
Electronic Stability Control and Traction Control system	146
Driver assistance systems	147
Cruise control	148
Speed limiter	150
Adaptive cruise control	152
Active emergency braking	159
Automatic post collision braking	162
Curve speed adaptation	163
Parking assist	164
Side blind spot alert	166
Panoramic view system	168
Rear view camera	171
Rear cross traffic alert	174
Traffic sign assistant	175
Lane keep assist	177

Advanced lane keep assist	179
Semi-automated lane change .	182
Driver alert	184
Charging	185
General information	185
Charging types	186
Charging cable	187
Programmable charging	192
Charging status	193
Fuel	193
Fuel for petrol engines	193
Fuel for diesel engines	194
Refuelling	195
Fuel consumption - CO ₂ -Emissions	197
Trailer hitch	198
General information	198
Driving characteristics and towing tips	198
Trailer towing	198
Towing equipment	199
Trailer stability assist	202

Driving hints

Control of the vehicle

Never coast with engine not running

Many systems will not function when the engine is not running, e.g. brake servo unit, power steering. Driving in this manner is a danger to yourself and others.

All systems function during an Autostop.

Stop-start system ⇨ 127.

Pedals

To ensure the pedal travel is uninhibited, there must be no mats in the area of the pedals.

Use only floor mats, which fit properly and are fixed by the retainers on the driver side.

Floor mats ⇨ 234.

Steering

If power steering assist is lost because the engine stops or due to a system malfunction, the vehicle can be steered but may require increased effort.

Emergencies

Warning

Damage to the high voltage battery or high voltage system can create a risk of electric shock, overheating, or fire.

If the vehicle has been damaged or affected by a moderate to severe crash, it must be inspected as soon as possible by qualified personnel. Until the technical inspection has been carried out, the vehicle must be stored outside at a minimum distance of 5 metres from any structure or other flammable objects.

If the vehicle has been damaged or affected by flood or fire, it must not be moved at all and has to be inspected by qualified personnel as soon as possible.

Starting and operating

New vehicle running-in

Do not brake unnecessarily hard for the first few journeys.

Only tow a trailer after the vehicle has driven at least 620 miles.

During the first drive, smoke may occur because of wax and oil evaporating off the exhaust system. Park the vehicle in the open for a while after the first drive and avoid inhaling the fumes.

During the running-in period, fuel and engine oil consumption may be higher.

Additionally, the cleaning process of the exhaust filter may take place more often.

Exhaust filter ↪ 131.

Ignition switch positions

Turn key:

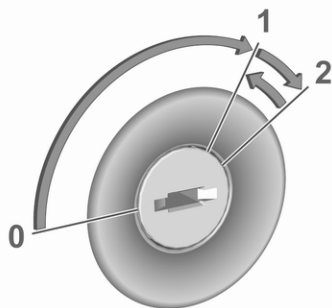

- 0** : ignition off: some functions remain active until key is removed or driver's door is opened, provided the ignition was on previously
- 1** : ignition on power mode: ignition is on, diesel engine is preheating, control indicators illuminate and most electrical functions are operable
- 2** : engine start: release key after engine has been started

Steering wheel lock

Remove key from ignition switch and turn steering wheel until it engages.

⚠ Danger

Never remove the key from ignition switch during driving as this will cause steering wheel lock.

Power button

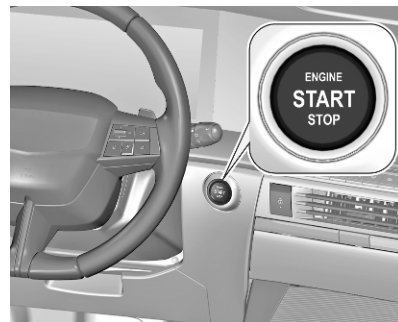

The electronic key must be inside the vehicle.

Engine start

Operate the clutch pedal (manual transmission), the brake pedal and press **Start/Stop**.

Ignition on power mode without starting the engine

Press **Start/Stop** without operating clutch or brake pedal. Control indicators illuminate and most electrical functions are operable.

Engine and ignition off

Press **Start/Stop** briefly in each mode or when engine is running and vehicle is stationary. Some functions remain active until driver's door is opened.

Emergency shut off during driving

Press **Start/Stop** for five seconds ↷ 126. Steering wheel locks as soon as vehicle is stationary.

Steering wheel lock

The steering wheel lock activates automatically when:

- the vehicle is stationary.
- the ignition has been switched off.

To release steering wheel lock, open and close driver's door and switch the ignition on power mode or start the engine directly.

⚠ Warning

If the vehicle battery is discharged, the vehicle must not be towed or tow-started as the steering wheel lock cannot be disengaged.

Operation in case of failure

If either the electronic key fails or the battery of the electronic key is weak, a message may be displayed in the Driver Information Centre.

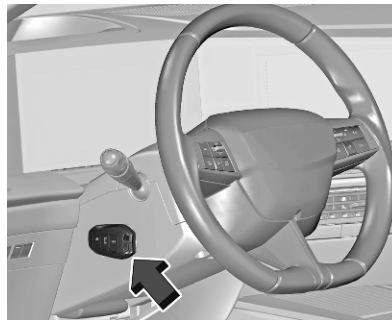

Hold the electronic key at the marking on the steering column cover as shown in the illustration.

On vehicles with manual transmission, select neutral gear, operate the clutch pedal, the brake pedal and press **Start/Stop**.

On vehicles with automatic transmission, set the selector to position **P**, operate the brake pedal and press **Start/Stop**.

This option is intended for emergencies only. Replace the electronic key battery as soon as possible ↷ 9.

For unlocking or locking the doors, see fault in radio remote control unit or electronic key system ↷ 10.

Starting the engine

Vehicles with ignition switch

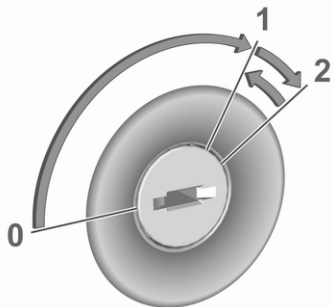

Turn key to position 1 to release the steering wheel lock.

Manual transmission: operate clutch and brake pedal.

Automatic transmission: operate brake pedal.

Do not operate accelerator pedal.

Diesel engines: wait until control indicator  extinguishes.

Turn key briefly to position 2 and release after engine has been started.

Manual transmission: during an Autostop, the engine can be started by depressing the clutch pedal ⇨ 127.

Automatic transmission: during an Autostop, the engine can be started by releasing the brake pedal ⇨ 127.

Vehicles with power button

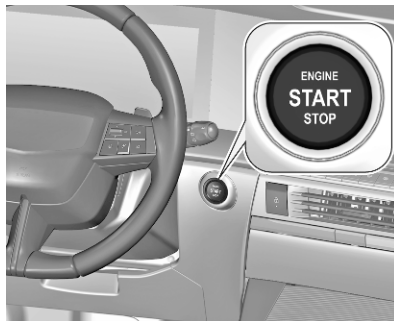

- Manual transmission: select neutral gear, operate clutch and brake pedal.
- Automatic transmission: operate brake pedal.
- Do not operate accelerator pedal.
- Press **Start/Stop** button.

- Release button after starting procedure begins. Diesel engine starts after control indicator  for preheating extinguishes.
- Before restarting or to switch off the engine when vehicle is stationary, press **Start/Stop** once more briefly.

To start the engine during an Autostop:

- Manual transmission: during an Autostop, the engine can be started by depressing the clutch pedal ⇨ 127.
- Automatic transmission: during an Autostop, the engine can be started by releasing the brake pedal ⇨ 127.

Electric vehicles

- Depress brake pedal.
- Press **Start/Stop** button for approx. two seconds.
- Keep the brake pedal depressed until **READY** is displayed in the Driver Information Centre and an acoustic signal is given.

Emergency shut off during driving

If the engine needs to be switched off during driving in case of emergency, press **Start/Stop** for five seconds.

Danger

Switching off the engine during driving may cause loss of power support for brake and steering systems. Assistance systems and airbag systems are disabled. Lighting and brake lights will extinguish. Therefore power down the engine and ignition while driving only when required in case of emergency.

Starting the vehicle at low temperatures

Starting the engine without additional heaters is possible down to -25 °C for diesel engines and -30 °C for petrol engines. Required is an engine oil with the correct viscosity, the correct fuel, performed services and a sufficiently charged vehicle battery. With temperatures below -30 °C the automatic transmission requires a warming phase of approx. five minutes. The selector lever must be in position **P**.

Turbo engine warm-up

Upon start-up, engine available torque may be limited for a short time, especially when the engine temperature is cold. The limitation is to allow the lubrication system to fully protect the engine.

Overrun cut-off

The fuel supply is automatically cut off during overrun, i.e. when the vehicle is driven with a gear engaged but accelerator pedal is released.

Depending on driving conditions, the overrun cut-off may be deactivated.

Stop-start system

The stop-start system helps to save fuel and to reduce the exhaust emissions. When conditions allow, it switches off the engine as soon as the vehicle is at a low speed or at a standstill, e.g. at a traffic light or in a traffic jam.

Activation

By default, the system is activated when the ignition is switched on.

The system can be manually activated in the Info Display.





Press  and activate the system in the Info Display.

Info Display  86.

The activation of the system is confirmed by a message.

Deactivation

Press  and deactivate the system in the Info Display.

Deactivation is confirmed by the illumination of  in the Driver Information Centre and the display of a message.

Autostop

Vehicles with manual transmission

Activate an Autostop as follows:

- Set the selector lever to neutral.
- Release the clutch pedal.

The engine will be switched off while the ignition stays on.

Vehicles with automatic transmission

If the vehicle is at a standstill with depressed brake pedal, Autostop is activated automatically.

The engine will be switched off while the ignition stays on.

The stop-start system will be disabled on steep inclines.

Indication



An Autostop is indicated by control indicator .

During an Autostop, the heating and brake performance will be maintained.

Conditions for an Autostop

The stop-start system checks if each of the following conditions is fulfilled.

- The stop-start system is not manually deactivated.
- The driver's door is closed or the driver's seat belt is fastened.
- The vehicle battery is sufficiently charged and in good condition.
- The engine is warmed up.
- The engine coolant temperature is not too high.
- The engine exhaust temperature is not too high, e.g. after driving with high engine load.
- The ambient temperature is between 0 °C and 35 °C.
- The climate control system allows an Autostop.
- The brake vacuum is sufficient.

- The self-cleaning function of the exhaust filter is not active.
- The vehicle was driven at least at walking speed since the last Autostop.

Autostop will be inhibited if these conditions are not met. In addition, Autostop may be inhibited

- by certain settings of the climate control system
- immediately after higher speed driving
- in the case of new vehicle running-in ⇨ 124
- by active demisting
- in the case of steep ascending or descending slopes
- if the vehicle has not exceeded 6 mph since the last engaged start.

In these cases, (A) flashes a few seconds and then goes off.

Notice

The Autostop may be inhibited for several hours after a battery replacement or reconnection.

Vehicle battery discharge protection

To ensure reliable engine restarts, several vehicle battery discharge protection features are implemented as part of the stop-start system.

Power saving measures

During an Autostop, several electrical features such as auxiliary electric heater or rear window heating are disabled or switched to a power saving mode. The fan speed of the climate control system is reduced to save power.

Restart of the engine by the driver

After the engine has been restarted, an Autostop is not available until the vehicle has reached a speed of 5 mph.

Vehicles with manual transmission

Depress the clutch pedal without depressing the brake pedal to restart the engine.

Vehicles with automatic transmission

The engine is restarted in the following cases:

- brake pedal released while **D** or **M** is selected
- brake pedal released and **N** selected when selector is moved to select **D** or **M**
- brake pedal depressed and **P** selected when selector is moved to select **R**, **N**, **D** or **M**
- **R** selected

Restart of the engine by the stop-start system

Vehicles with manual transmission: The selector must be in neutral to enable an automatic restart.

If one of the following conditions occurs during an Autostop, the engine will be restarted automatically by the stop-start system:

- stop-start system manually deactivated
- driver's seat belt unfastened and driver's door opened
- engine temperature too low

- charging level of vehicle battery below a defined level
- brake vacuum not sufficient
- vehicle is driven or rolls at least at walking speed
- climate control system requests engine start
- air conditioning manually switched on
- the bonnet is opened

If an electrical accessory, e.g. a portable CD player, is connected to the power outlet, a brief power drop during the restart might be noticeable.

Parking

Warning

- Do not park the vehicle on an easily ignitable surface. The high temperature of the exhaust system could ignite the surface.
- Always apply the parking brake.

- If the vehicle is on a level surface or uphill slope, engage first gear or set the selector lever to position **P**. On an uphill slope, turn the front wheels away from the kerb.

If the vehicle is on a downhill slope, engage reverse gear or set the selector lever to position **P**. Turn the front wheels towards the kerb.

- Close the windows.
- Switch off the engine.
- Remove the ignition key from the ignition switch or switch off ignition on vehicles with power button. Turn the steering wheel until the steering wheel lock is felt to engage.

- Lock the vehicle.
- Activate the anti-theft alarm system.
- The engine cooling fans may run after the engine has been switched off ⇨ 207.

Caution

After running at high engine speeds or with high engine loads, operate the engine briefly at a low load or run in neutral for approx. 60 seconds before switching off, in order to protect the turbocharger.

In countries with extremely low temperatures it may be necessary to park the vehicle without applied parking brake. Make sure to park the vehicle on a level surface.

Parking brake ⇨ 143.

Engine exhaust

Danger

Engine exhaust gases contain poisonous carbon monoxide, which is colourless and odourless and could be fatal if inhaled.



If exhaust gases enter the interior of the vehicle, open the windows. Have the cause of the fault rectified by a workshop.

Avoid driving with an open load compartment, otherwise exhaust gases could enter the vehicle.

Exhaust filter

Automatic cleaning process

The exhaust filter system filters soot particles out of the exhaust gases.



The start of saturation of the exhaust filter is indicated by the temporary illumination of  or , accompanied by a message in the Driver Information Centre.

As soon as the traffic conditions permit, regenerate the filter by driving at a vehicle speed of at least 40 mph until the control indicator extinguishes.

Notice

On a new vehicle, the first exhaust filter regeneration operations may be accompanied by a burning smell, which is normal. Following prolonged operation of the vehicle at very low speed or at idle, water vapour can be emitted at the exhaust on acceleration. This does not affect the behaviour of the vehicle or the environment.

Cleaning process not possible



If  or  stays on, accompanied by an audible signal and a message, this indicates that the exhaust filter additive level is too low.

The reservoir must be topped-up without delay. Seek the assistance of a workshop.

Catalytic converter

The catalytic converter reduces the amount of harmful substances in the exhaust gases.

Caution

Fuel grades other than those listed on pages  193,  243 could damage the catalytic converter or electronic components.

Unburnt petrol will overheat and damage the catalytic converter. Therefore avoid excessive use of the starter, running the fuel tank dry and starting the engine by pushing or towing.

In the event of misfiring, uneven engine running, a reduction in engine performance or other unusual problems, have the cause of the fault rectified by a workshop as soon as possible. In an emergency, driving can be continued for a short period, keeping vehicle speed and engine speed low.

AdBlue

General information

The selective catalytic reduction (BlueInjection) is a method to substantially reduce the nitrogen oxides in the exhaust emission. This is achieved by injecting a Diesel Exhaust Fluid (DEF) into the exhaust system. The ammonia released by the fluid reacts with nitrous gases (NO_x) from the exhaust and turns it into nitrogen and water.

The designation of this fluid is AdBlue®. It is a non-toxic, non-flammable, colourless and odourless fluid which consists of 32% urea and 68% water.

Warning

Avoid contact of your eyes or skin with AdBlue.

In case of eye or skin contact, rinse off with water.

Caution

Avoid contact of the paintwork with AdBlue.

In case of contact, rinse off with water.

AdBlue freezes at a temperature of approx. -11 °C. As the vehicle is equipped with an AdBlue pre-heater, the emissions reduction at low temperatures is ensured. The AdBlue pre-heater works automatically.

Notice

Frozen and again liquefied AdBlue is usable without quality loss.



The typical AdBlue consumption is approx. 2 l per 600 miles, but can also be higher depending on driving behaviour (e.g. high load or towing).

Level warnings

Depending on the calculated range of AdBlue, different messages are displayed in the Driver Information Centre. The messages and the restrictions are a legal requirement.

1. The first warning level is entered when the estimated AdBlue range is between 1500 miles and 500 miles.

When switching on the ignition, this warning will show up once briefly with the calculated range. Additionally, control indicator  will illuminate and a chime will sound. Driving is possible without any restrictions.

2. The next warning level is entered when the estimated AdBlue range is below 500 miles. The message with the current range will always be displayed when ignition is switched on. Additionally, control indicator  will flash and a chime will sound. Refill AdBlue before entering the next warning level.
3. The next warning level is entered with a range below 60 miles. The message with the current range will always be displayed when ignition is switched on. Additionally, control indicator  will flash and a chime will sound. Refill AdBlue as soon as

possible before the AdBlue tank is completely empty. Otherwise, a restart of the engine will not be possible.



4. The last warning level is entered when the AdBlue tank is empty. Restart of the engine is not possible.

A message appears in the Driver Information Centre. Additionally, control indicator  will flash and a chime will sound.

Refill the AdBlue tank completely, otherwise restarting of the engine is not possible.

High emission warnings

In the event of a fault with the emissions control system, different messages are displayed in the Driver Information Centre.

The messages and the restrictions are a legal requirement. The warning messages are accompanied by the control indicators ,  and . Additionally, a chime will sound.

Follow the instructions of the warning messages. If starting is prevented, seek the assistance of a workshop.

Refilling AdBlue

Caution

Only use AdBlue that complies with European standards DIN 70 070 and ISO 22241-1.

Do not use additives.

Do not dilute AdBlue.

Otherwise the selective catalytic reduction system could be damaged.

The AdBlue tank should be filled completely. This must be done if the warning message regarding prevention of an engine restart is already displayed.

AdBlue refilling quantity ⇨ 247.

Notice

Whenever a filling pump with a nozzle for passenger cars is not available at a filling station, use only AdBlue bottles or canisters with a

sealed refill adapter for refilling, to prevent splashback and overspill, and in order to ensure that the fumes from the AdBlue tank are captured and do not emerge.

Since AdBlue has a limited durability, check the date of expiry before refilling.

Notice

Refill the AdBlue tank to a level of at least 10 l, to ensure that the new AdBlue level is being detected.

In case AdBlue refill is not successfully detected:

1. Continuously drive the vehicle for ten minutes making sure that vehicle speed is always higher than 12 mph.
2. If AdBlue refill is detected successfully, AdBlue supply-driven warnings or limitations will disappear.

If AdBlue refill is still not detected, seek the assistance of a workshop.

If AdBlue must be refilled at temperatures below -11 °C, the refilling of AdBlue may not be detected by the system. In this

event, park the vehicle in a space with a higher ambient temperature until AdBlue is liquified.

Notice

When unscrewing the protective cap from the filler neck, ammonia fumes may emerge. Do not inhale as the fumes have a pungent smell. The fumes are not harmful by inhalation.

The vehicle must be parked on a level surface.

The filler neck for AdBlue is located behind the fuel filler flap.

The fuel filler flap can only be opened if the vehicle is unlocked.

1. Switch off the ignition.
2. Close all doors to avoid ammonia fumes entering the interior of the vehicle.
3. Release the fuel filler flap by pushing the flap ↗ 195.



4. Unscrew protective cap from the filler neck.
5. Open AdBlue canister.
6. Mount one end of the hose on the canister and screw the other end on the filler neck.
7. Lift the canister until it is empty, or until the flow from the canister has stopped.
8. Place the canister on the ground to empty the hose, wait 15 seconds.
9. Unscrew the hose from the filler neck.
10. Mount the protective cap and turn clockwise until it engages.

Notice

Dispose of AdBlue canister according to environmental requirements. Hose can be reused after flushing with clear water before AdBlue dries out.

Automatic transmission electrified

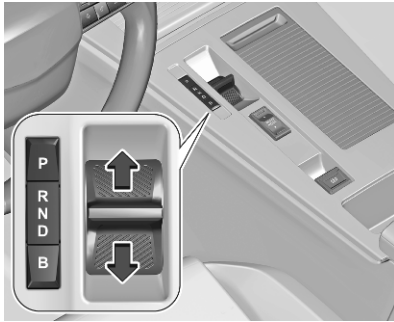

This vehicle is a plug-in hybrid vehicle. It has a combustion engine and an automatic transmission with integrated electrical engine which enables electrical driving and charging of the battery during the deceleration and the braking of the vehicle. Additionally, the battery can be charged using a cable, e.g., at domestic electric outlets or public charging stations.

- P** : park position, front wheels are blocked, engage only when the vehicle is stationary
- R** : reverse gear, engage only when the vehicle is stationary
- N** : neutral
- D** : automatic mode, low recuperation
- B** : automatic mode with one-pedal driving

Shifting

Shifting always starts from a centre position and is operated by moving the selector. Once operated, the selector will return to the centre position. The selected mode is indicated in the Driver Information Centre.

Park position P

Warning

Do not leave the vehicle when the propulsion system is running, the vehicle may move suddenly. You or others can be injured. To be sure the vehicle will not move,

even if you are on even ground, make sure the parking brake is applied and **P** is selected.

To shift into **P**, press button **P**.

To shift out of **P**, depress the brake pedal and select the desired mode.

The vehicle will not shift into **P** if it is moving too fast. Stop the vehicle and shift into **P**.

The vehicle automatically shifts into **P** when

- the ignition is switched off
- the driver's door is opened while the vehicle's speed is below 3 mph

If the ignition is switched off while **N** is selected, the vehicle shifts into **P** after a delay of approx. five seconds.

Reverse gear R

To shift into and out of **R**, the vehicle must be at standstill and the brake pedal has to be depressed.

Caution

Shifting into **R** while the vehicle is moving forward could damage the electric drive unit. Only shift into **R** after the vehicle has been stopped.

Neutral N

In this mode, the propulsion system does not transfer torque to the wheels. To restart the propulsion system when the vehicle is already moving, use **D** only.

When **N** is selected, **P** is engaged after a short time.

If the driver's door is opened while **N** is selected, an audible signal is given and **P** is engaged. The audible signal stops when the driver's door is closed.

Drive mode D**Notice**

In slippery conditions, operate the vehicle in **D** for enhanced riding and handling performance.

Notice

In slippery conditions, operate the vehicle in **D** for enhanced riding and handling performance.

One-pedal driving B

In this mode, vehicle speed is significantly reduced by releasing the accelerator pedal, without operating the brake pedal.

Use **B** when driving down steep hills, in deep snow, in mud or in stop-and-go traffic.

Warning

In the case of extreme temperatures or if the high voltage battery is almost fully charged, the brake force of the regenerative braking may be temporarily reduced. If the braking force is not sufficient, the driver has to be prepared to use the brake pedal.

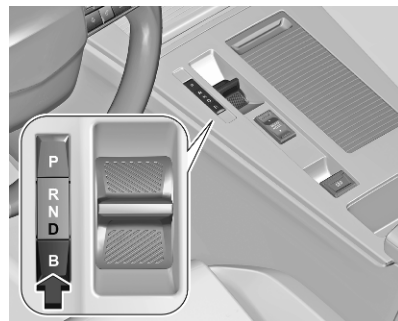

To activate **B**, select **D** and press button **B**

Do not accelerate while engaging a gear. Never depress the accelerator pedal and brake pedal at the same time.

When a gear is engaged, the vehicle slowly begins to creep when the brake is released.

To deactivate **B**, press button **B**.
Regenerative braking ⇄ 146.

Free wheeling

To avoid that the vehicle shifts from **N** into **P**, enable free wheeling:

With the vehicle stationary and the engine running, depress the brake pedal and select **N**.

Within five seconds do the following:

1. Depress and hold the brake pedal.
2. Switch off the ignition and move the selector forwards or backwards.
3. Take your foot off the brake pedal and switch on the ignition.
4. Depress and hold the brake pedal and push the electric parking brake to release it.
5. Take your foot off the brake pedal and switch off the ignition.

A message is displayed in the Driver Information Centre indicating that the wheels are unblocked for the next 15 minutes.

To revert to normal operation, depress the brake pedal and switch on the engine.

Parking brake ⇨ 143.

Deactivating the automatic operation of **P** mode for hybrid vehicles

The procedure for the deactivation of the automatic operation of **P** mode also deactivates the automatic operation of the electric parking brake.

For this procedure, refer to the description of the automatic parking brake.

Parking brake ⇨ 143

Automatic transmission

The automatic transmission permits automatic gearshifting (automatic mode) or manual gearshifting (manual mode).

Manual mode ⇨ 139.

Transmission display

The mode or selected gear is shown in the Driver Information Centre.

In automatic mode, the driving programme is indicated by **D**.

R indicates reverse gear.

N indicates neutral mode.

P indicates park mode.

M indicates manual mode. The number of the selected gear is indicated.

Gear selection

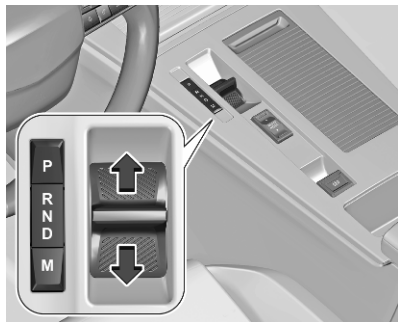

Move the selector or press the respective buttons.

- P** : park position, front wheels are blocked, engage only when the vehicle is stationary
- R** : reverse gear, engage only when the vehicle is stationary
- N** : neutral
- D** : automatic mode
- M** : manual mode

Shifting

Shifting always starts from a centre position and is operated by moving the selector. Once operated, the

selector will return to the centre position. The selected mode is indicated in the Driver Information Centre.

Park position P

⚠ Warning

Do not leave the vehicle when the propulsion system is running, the vehicle may move suddenly. You or others can be injured. To be sure the vehicle will not move, even if you are on even ground, make sure the parking brake is applied and **P** is selected.

To shift into **P**, press button **P**.

To shift out of **P**, depress the brake pedal and select the desired mode.

The vehicle will not shift into **P** if it is moving too fast. Stop the vehicle and shift into **P**.

The vehicle automatically shifts into **P** when

- the ignition is switched off
- the driver's door is opened while the vehicle's speed is below 3 mph

If the ignition is switched off while **N** is selected, the vehicle shifts into **P** after a delay of approx. five seconds.

To avoid that the vehicle shifts from **N** into **P**, enable free wheeling:

With the vehicle stationary and the engine running, depress the brake pedal and select **N**.

Within 5 seconds do the following:

1. Depress and hold the brake pedal.
2. Switch off the ignition and move the selector forwards or backwards.
3. Take your foot off the brake pedal and switch on the ignition.
4. Depress and hold the brake pedal and push the electric parking brake to release it.
5. Take your foot off the brake pedal and switch off the ignition.

A message is displayed in the Driver Information Centre indicating that the wheels are unblocked for the next 15 minutes.

To revert to normal operation, depress the brake pedal and switch on the engine.

Parking brake ⇨ 143.

Reverse gear R

To shift into and out of **R**, the vehicle must be at standstill and the brake pedal has to be depressed.

Neutral N

In this mode, the propulsion system does not transfer torque to the wheels. To restart the propulsion system when the vehicle is already moving, use **D** only.

When **N** is selected, **P** is engaged after a short time.

If the driver's door is opened while **N** is selected, an audible signal is given and **P** is engaged. The audible signal stops when the driver's door is closed.

Automatic mode D

Notice

In slippery conditions, operate the vehicle in **D** for enhanced riding and handling performance.

Manual mode M

In this mode, it is possible to change gears manually using steering wheel paddles.

Manual mode ⇨ 139.

Engine braking

To utilise the engine braking effect, select a lower gear in good time when driving downhill.

Manual mode ⇨ 139.

Deactivation of the automatic operation of park position P and of electric parking brake

For this procedure, refer to the description of the automatic parking brake.

Parking brake ⇨ 143

Manual mode

Manual mode **M** can be activated in each driving situation and speed when **D** is selected.

The selected gear is indicated in the Driver Information Centre.

If a higher gear is selected when vehicle speed is too low, or a lower gear when vehicle speed is too high, the shift is not executed. This can cause a message in the Driver Information Centre.

In manual mode, no automatic shifting to a higher gear takes place at high engine revolutions.

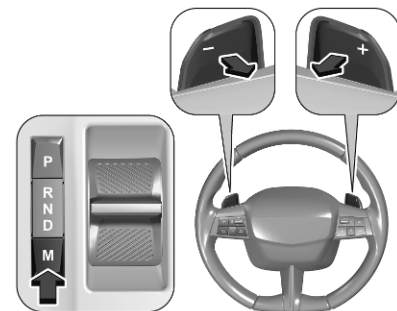

Press button **M**.

Pull steering wheel paddles to select gears manually.

Pull right paddle **+** to shift to a higher gear.

Pull left paddle **-** to shift to a lower gear.

Multiple pulls allow gears to be skipped.

Gear shift indication

The symbol ▲ or ▼ with a number beside it is indicated when gearshifting is recommended for fuel saving reasons.

Shift indication appears only in manual mode.

Electronic driving programmes

Following a cold start, the operating temperature programme increases engine speed to quickly bring the catalytic converter to the required temperature.

Special programmes automatically adapt the shifting points when driving up inclines or down hills.

In snowy or icy conditions or on other slippery surfaces, the electronic transmission control enables the driver to select manually first, second or third gear for starting off.

Kickdown

Pressing down the accelerator pedal beyond the kickdown detent will lead to maximum acceleration independent of selected driving mode. The transmission shifts to a lower gear depending on engine speed.

Fault

In the event of a fault,  illuminates a message is displayed in the Driver Information Centre.

Vehicle messages ⇨ 89.

Electronic transmission control enables only third gear. The transmission no longer shifts automatically.

Do not drive faster than 62 mph.

Have the cause of the fault remedied by a workshop.

Interruption of power supply

In the event of an interruption of power supply, it is not possible to select another mode when **P** is selected.

Towing the vehicle ⇨ 230.

If the vehicle battery is discharged, start the vehicle using jump leads ⇨ 228.

If the vehicle battery is not the cause of the fault, seek the assistance of a workshop.

Manual transmission

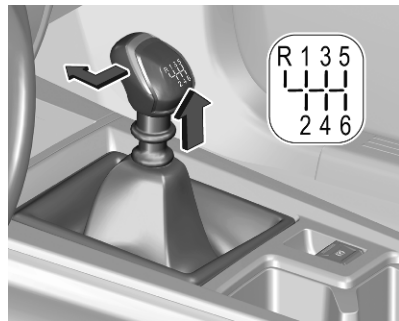

To engage reverse, with the vehicle stationary and engine at idle depress the clutch pedal, pull the ring under the selector lever and engage the gear.

If the gear does not engage, set the selector lever to neutral, release the clutch pedal and depress again. Then repeat gear selection.

Do not slip the clutch unnecessarily.

When operating, depress the clutch pedal completely. Do not use the pedal as a foot rest.

When clutch slip is detected for a specific time, the engine power will be reduced. A warning is displayed in the Driver Information Centre. Release the clutch.

Caution

It is not advisable to drive with the hand resting on the selector lever.

Gear shift indication ⇨ 82.

Stop-start system ⇨ 127.

Drive systems

Drive modes

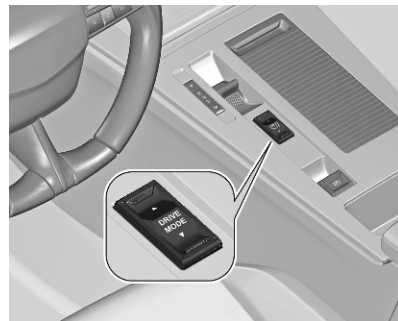

To select the respective drive mode, use the shown toggle switch.

Internal combustion engine

The following drive modes are selectable.

Normal mode

The settings in this mode are set by default. Everytime the ignition is switched on, this mode is selected.

Sport mode

Vehicles with manual transmission:
This mode allows to obtain a more dynamic driving with action on the power steering, accelerator and the possibility of displaying the vehicle's dynamic settings on the instrument panel.

Vehicles with automatic transmission:
This mode allows to obtain a more dynamic driving with action on the power steering, accelerator and gear changes. Depending on version, it is possible to display the vehicle's dynamic settings on the instrument panel and activate / deactivate the display colour.

Eco mode

This mode reduces the fuel consumption by optimising the operation of the heating and air conditioning.

While coasting the vehicle, the engine is idling with reduced engine brake.

Hybrid

The following drive modes are selectable.

Electric mode

This mode allows 100% electric driving.

The maximum speed is approx. 84 mph.

This mode is selected by default when the vehicle is started. If the conditions do not allow this mode, a message is displayed and hybrid mode is selected.

Hybrid mode

This mode optimises the vehicle's fuel consumption by simultaneous or alternation operation of internal combustion engine and electrical engine depending on driving conditions and driving style.

In this mode, driving 100% electrically is possible if the charge level of the high voltage battery is sufficient and acceleration requirements are modest.

Sport mode

This mode allows more dynamic driving. Electric energy is used to support the internal combustion

engine as long as there is enough electric energy in the high voltage battery left.

Brakes

Antilock brake system

Antilock brake system (ABS) prevents the wheels from locking.

ABS starts to regulate brake pressure as soon as a wheel shows a tendency to lock. The vehicle remains steerable, even during hard braking.

ABS control is made apparent through a pulse in the brake pedal and the noise of the regulation process.

For optimum braking, keep the brake pedal fully depressed throughout the braking process, despite the fact that the pedal is pulsating. Do not reduce the pressure on the pedal.

When braking in an emergency, the hazard warning flashers are switched on automatically depending on the force of deceleration. They are switched off automatically the first time you accelerate.

After starting off, the system performs a self-test which may be audible.



Control indicator (ABS) ⇨ 82.

Fault

⚠ Warning

If there is a fault in the ABS, the wheels may be liable to lock due to braking that is heavier than normal. The advantages of ABS are no longer available. During hard braking, the vehicle can no longer be steered and may swerve.

Have the cause of the fault remedied by a workshop.

Parking brake

⚠ Warning

Before leaving the vehicle, check parking brake status. Control indicator (P) illuminate constantly when electric parking brake is applied.

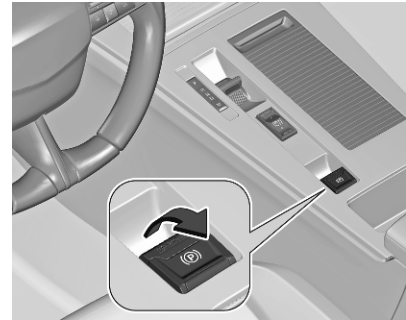

Applying when vehicle is stationary

Pull the switch (P). If the control indicator (P) illuminates, the electric parking brake is applied.

Control indicator (P) ⇨ 81.

The electric parking brake can always be activated, even if the ignition is off.

Do not operate electric parking brake system too often without the engine running as this will discharge the vehicle battery.

Releasing

Switch on ignition. Keep the brake pedal depressed and then push the switch (P). If the control indicator (P) extinguishes, the electric parking brake is released.

Drive away function

Vehicles with manual transmission: Depressing the clutch pedal and then slightly releasing the clutch pedal and slightly depressing the accelerator pedal releases the electric parking brake automatically. This is only possible if the automatic operation of the electric parking brake is activated. It is not possible when switch (P) is pulled at the same time.

Vehicles with automatic transmission: Engaging **R**, **D** or **M** and then depressing the accelerator pedal releases the electric parking brake automatically. This is only possible if the automatic operation of the electric parking brake is activated. It is not possible when switch (P) is pulled at the same time.

Braking when vehicle is moving

When the vehicle is moving and the switch (P) is kept pulled, the electric parking brake system will decelerate the vehicle. As soon as the switch (P) is released, braking will be stopped.

The antilock brake system and the Electronic Stability Control stabilise the vehicle while the switch (P) is kept pulled. If an error of the electric parking brake occurs, a warning message is displayed in the driver information centre. If the antilock brake system and the Electronic Stability Control fail, one or both indicators (ABS) and  illuminate in the Driver Information Centre. In this case, stability during deceleration of

the vehicle can only be maintained with repeated short pulls of the switch until the vehicle is immobilised.

Automatic operation

Automatic operation includes automatic application and automatic release of the electric parking brake.

The electric parking brake can also be applied or released manually by using the switch (P).

Automatic application:

- The electric parking brake is automatically applied when the vehicle is stationary and the ignition is switched off.
- (P) illuminates in the Driver Information Centre and message is displayed to confirm the application.

Automatic release:

Notice

The automatic release of the electric parking brake is inhibited as long as the driver's door is open.

- Parking brake releases automatically on driving off.
- (P) extinguishes in the Driver Information Centre and a display message pops up to confirm the release.

Deactivation of automatic operation

In certain situations, e.g. in extreme cold weather conditions or when towing, it may be necessary to deactivate the automatic operation of the electric parking brake.

1. Start the engine.
2. If the parking brake is released, pull the switch (P) to apply the parking brake.
3. Take your foot off the brake pedal.
4. Press the switch (P) for at least ten seconds and maximum 15 seconds.
5. Release the switch (P).
6. Depress and hold the brake pedal.
7. Pull the switch (P) for two seconds.

The deactivation of the automatic operation is confirmed by the illumination of  in the Driver Information Centre. Now, the electric parking brake can only be applied and released manually.

To reactivate the automatic operation, repeat the steps described above.

The automatic operation can also be deactivated temporarily, i.e. until the next ignition cycle:

1. With the vehicle stationary and the engine running, depress the brake pedal and move the gear selector to the neutral position.
2. While depressing the brake pedal, switch off the ignition.
3. Take your foot off the brake pedal and switch on the ignition.
4. Depress and hold the brake pedal and push the electric parking brake to release it.
5. Take your foot off the brake pedal and switch off the ignition.

To revert to normal operation, depress the brake pedal and switch on the engine.

Gear selection ⇨ 138.

Manual transmission ⇨ 141.

Fault

Failure mode of electric parking brake is indicated by a control indicator ! and by a message displayed in the Driver Information Centre.

Vehicle messages ⇨ 89.

Control indicator  flashes: electric parking brake is not fully applied or released. When continuously flashing, release electric parking brake and retry applying.

Brake assist

If the brake pedal is depressed quickly and forcefully, maximum brake force is automatically applied.

The operation of the brake assist might become apparent by a pulse in the brake pedal and a greater resistance when depressing the brake pedal.

Maintain steady pressure on the brake pedal as long as full braking is required. Maximum brake force is automatically reduced when brake pedal is released.

Hill start assist

The system helps prevent unintended movement when driving away on inclines.

When releasing the brake pedal after stopping on an incline, brakes remain on for further two seconds. The brakes release automatically as soon as the vehicle begins to accelerate.

The system is active if the following conditions are met:

- vehicle stationary
- brake pedal depressed
- driver's door closed

Regenerative braking

Warning

In the case of extreme temperatures or if the high voltage battery is almost fully charged, the brake force of the engine braking may be temporarily reduced. If the braking force is not sufficient, the driver has to be prepared to use the brake pedal.

Warning

Depending on the engine braking force the brake lights are illuminated.

Regenerative braking generates electrical energy resulting from engine braking to charge the high voltage battery.

Automated transmission electrified
⇨ 135.

Ride control systems

Electronic Stability Control and Traction Control system

Electronic Stability Control improves driving stability when necessary, regardless of the type of road surface or tyre grip.

As soon as the vehicle starts to swerve (understeer / oversteer), engine output is reduced and the wheels are braked individually.

Electronic Stability Control operates in combination with the Traction Control system. It prevents the driven wheels from spinning.

The Traction Control system is a component of the Electronic Stability Control.

The Traction Control system improves driving stability when necessary, regardless of the type of road surface or tyre grip, by preventing the driven wheels from spinning.

As soon as the driven wheels starts to spin, engine output is reduced and the wheel spinning the most is braked individually. This considerably improves the driving stability of the vehicle on slippery road surfaces.



Electronic Stability Control and the Traction Control system are operational after each engine start as soon as the control indicator  extinguishes.

When Electronic Stability Control or the Traction Control system operates,  flashes.

On some occasions, e.g. after disconnecting the vehicle battery, the control indicator  may illuminate during some seconds accompanied by a message in the Driver Information Centre. This may be caused by the reset of the steering angle sensor.

⚠ Warning

Do not let this special safety feature tempt you into taking risks when driving.

Adapt speed to the road conditions.

Control indicator  ⇨ 83.

Deactivation / Reactivation

Press  and deactivate / reactivate **Traction Control** in the Info Display.

Deactivation is confirmed by the illumination of  and a message in the Driver Information Centre.

Fault

If there is a fault in the system, the control indicator  illuminates continuously, a message appears in the Driver Information Centre and a warning chime sounds. The system is not operational.

Have the cause of the fault remedied by a workshop.

Driver assistance systems

⚠ Warning

Driver assistance systems are developed to support the driver and not to replace the driver's attention.

The driver accepts full responsibility when driving the vehicle.

When using driver assistance systems, always take care regarding the current traffic situation.

⚠ Warning

The usage of a license plate support on the front bumper may affect the proper radar unit functionality.

When using a license plate support, follow the markings and indications on the front bumper.

Cruise control

The cruise control can store and maintain speeds above 25 mph. For vehicles with manual transmission, any gear has to be selected. For vehicles with automatic transmission, position **D** or the second or a higher gear in position **M** must be selected.

Deviations from the stored speeds may occur when driving uphill or downhill.

The system maintains the vehicle speed at the preset speed by the driver, without any action on the accelerator pedal.

The preset speed can be exceeded temporarily by pressing the accelerator pedal firmly.

The status and preset speed is displayed in the Driver Information Centre.

Do not use the cruise control if it is not advisable to maintain a constant speed.

Switching on the system



Press .





The cruise control screen is displayed.  is grey indicating that the system is still not active.

Activation of the functionality

If all operating conditions are met, **OK?** is displayed.

Press **OK** to store the current vehicle speed as speed setting and activate the cruise control.  changes from grey to green indicating that system is active. The accelerator pedal can be released.

Alternatively, move the thumb wheel to  to increase or  to decrease the speed and store this speed as speed setting. Cruise control is immediately activated if the thumbwheel is moved upwards or downwards.  changes from grey to green.

Setting speed by the driver



If the system is active, the preset speed can be changed by moving the thumb wheel to \curvearrowright + to increase or \curvearrowright - to decrease the speed. Move thumb wheel repeatedly to change speed in small steps, move and hold to change speed in large steps.

Adopting speed by the speed limit recognition

A detected speed limit can be used as new set speed for the cruise control. To detect speed limit sign, the traffic sign assistant has to be activated.

Traffic sign assistant \curvearrowright 175.

When passing the speed limit sign
OK? is automatically displayed.

Press **OK** on the steering wheel to store the suggested speed.

The suggested speed is shown as new speed setting.

After passing the speed limit sign

Press **OK** on the steering wheel.

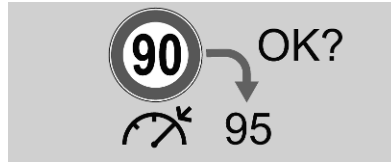

OK? is displayed

Press **OK** to store the suggested speed.

The suggested speed is shown as new speed setting.

Exceeding the set speed

It is always possible to drive faster than the set speed by depressing the accelerator pedal. When the accelerator pedal is released, the vehicle returns to the stored speed.

While the set speed is exceeded, the set speed setting flashes.

Deactivation of the functionality

Press **||▶**. The vehicle is driven without cruise control.

Cruise control is deactivated, but not switched off. Last stored speed remains in memory for later speed resume.

The cruise control may be deactivated automatically in the following cases:

- brake pedal depressed
- traction control system or electronic stability control is operating
- reverse gear engaged, **N** selected or no gear engaged
- clutch pedal depressed for more than five seconds
- electric parking brake engaged

Resume stored speed

Press **||▶**

Switching off the system

Press \curvearrowright X, the cruise control mode is deselected and the cruise control screen is hidden from the Driver Information Centre.

System limitations

Never use the system in the following situations:

- In an urban area with the risk of pedestrians crossing the road.
- In heavy traffic (except versions with the Stop & Go function).
- On winding or steep roads.
- On slippery or flooded roads.
- In poor weather conditions.
- In the event of restricted visibility for the driver.
- Driving on a speed circuit.
- Driving on a rolling road.
- When using snow chains, non-slip covers or studded tyres.

When driving down a steep hill, the system cannot prevent the vehicle from exceeding the set speed. Brake if necessary.

When driving up a steep hill or when towing, the set speed may not be reached or maintained.

Fault

The speed limit recognition may not operate correctly if traffic signs do not comply with the Vienna Convention on Road Signs and Signals.

In the event of a cruise control fault, the speed is cleared resulting in flashing of the dashes.

Have the system checked by a workshop.

Speed limiter

The speed limiter prevents the vehicle from exceeding a preset maximum speed.

The maximum speed can be set at speeds above 18 mph.

The driver can accelerate the vehicle up to the preset speed. Deviations from the limited speed may occur when driving downhill.

Switching on the system



Press .





The speed limiter screen is displayed.  is grey indicating that the system is still not active.

Activation of the functionality

Press **OK** or **||▶** to activate the speed limiter and store the current vehicle speed as speed setting.  is illuminated in green.

Setting speed by the driver



The preset speed can be changed by moving the thumb wheel to + to increase or - to decrease the speed. Move thumb wheel repeatedly to change speed in small steps, move and hold to change speed in large steps.

Adopting speed by the speed limit recognition

A detected speed limit can be used as new set speed for the speed limiter. To detect speed limit signs, the traffic sign assistant has to be activated.

Traffic sign assistant  175.

When passing the speed limit sign **OK?** is automatically displayed.

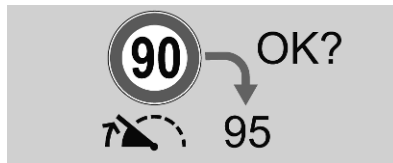

Press **OK** on the steering wheel to store the suggested speed.

The suggested speed is shown as new speed setting.

After passing the speed limit sign

Press **OK** on the steering wheel.

OK? is displayed.

Press **OK** to store the suggested speed.

The suggested speed is shown as new speed setting.

Exceeding the speed limit

In the event of an emergency, it is possible to exceed the speed limit by depressing the accelerator pedal firmly to the final point. In this case, the preset speed value flashes.

Release the accelerator pedal and the speed limiter function is reactivated once a speed lower than the limit speed is obtained.

When exceeding the preset speed is not caused by depressing the accelerator pedal, e.g., when driving down a steep slope, an audible signal is given.

Warning

On a steep descent or in the event of sharp acceleration, the speed limiter will not be able to prevent the vehicle from exceeding the preset speed. If necessary, depress the brake pedal to control the vehicle's speed.

Deactivation of the functionality

Press **II▶**, speed limiter is in pause mode and a message is displayed. The vehicle is driven without speed limiter.

Speed limiter is deactivated, but not switched off. Last stored speed remains in memory for later speed resume.

Resume limit speed

Press **II▶**, the stored speed limit will be obtained.

Switching off the system

Press  the speed limiter mode is deselected and the speed limiter screen is hidden from the Driver Information Centre.

Fault

The speed limit recognition may not operate correctly if traffic signs do not comply with the Vienna Convention on Road Signs and Signals.

In the event of a speed limiter fault, the speed is cleared resulting in flashing of the dashes.

Have the system checked by a workshop.

Adaptive cruise control

The adaptive cruise control is an enhancement of the cruise control with the additional feature of maintaining a certain following distance to the vehicle ahead.



It uses a camera located at the top of the windscreen and a radar unit located in the front bumper to detect the vehicles ahead. If no vehicle is detected in the driving path, the adaptive cruise control behaves like a conventional cruise control.

The adaptive cruise control automatically decelerates the vehicle when approaching a slower moving vehicle. It then adjusts the vehicle speed to follow the vehicle ahead at the selected following distance. The vehicle speed increases or decreases to follow the vehicle ahead, but will not exceed the set speed. It may apply limited braking with activated brake lights.

If the vehicle ahead accelerates or changes lane, the adaptive cruise control progressively accelerates the vehicle to return to the stored set speed. If the driver operates the turn lights to overtake a slower vehicle, the adaptive cruise control allows the vehicle to temporarily approach the vehicle ahead to help passing it. However, the set speed will never be exceeded.

If the vehicle ahead is moving too slowly and the selected following distance cannot be maintained anymore, a warning chime is given and a message is displayed. The message prompts the driver to take back control of the vehicle. On

vehicles with manual transmission, the system can brake the vehicle until 19 mph. On vehicles with automatic transmission, the system can brake the vehicle until a full stop. Depending on version, the system can automatically accelerate the vehicle after a full stop.

⚠ Warning

The brake lamps come on if the vehicle is slowed down by active emergency braking.
If the brake lights fail, the system does not operate.

Switching on the system

Press  and make sure the **Drive Assist** is activated in the Info Display.



Press  successively until the adaptive cruise control mode is selected.

The adaptive cruise control screen is displayed. The system is still not activated.

Operation conditions

The system can be activated if the following conditions are met:

- vehicle speed between 19 mph and 112 mph for vehicles with manual transmission, between 0 mph and 112 mph for vehicles with automatic transmission
- driver's door closed



- driver's seat belt fastened
- **D** selected or second or higher gear engaged
- parking brake released
- brake pedal depressed if vehicle stationary

Activation of the functionality

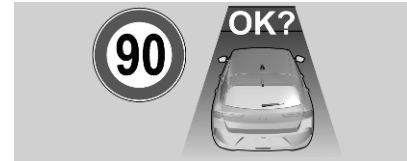
If all operating conditions are met, **OK?** is displayed.



Press **OK** to store the current vehicle speed and activate the cruise control. On the adaptive cruise control screen, the set speed and a road element are displayed in green. The accelerator pedal can be released.

Alternatively, move the thumb wheel to  to increase or  to decrease the speed and store this speed. The cruise control is immediately activated if the thumbwheel is moved

upwards or downwards. On the adaptive cruise control screen, the set speed and the road element are displayed in green.

Setting speed by the driver



The set speed can be changed by moving the thumb wheel to to increase or to decrease the speed. Move thumb wheel repeatedly to change speed in small steps, move and hold to change speed in large steps.

Adopting speed by the speed limit recognition

A detected speed limit can be used as new value for the adaptive cruise control.

When passing the speed limit sign **OK?** is automatically displayed.

Press **OK** on the steering wheel to store the suggested speed.

The suggested speed is shown as new speed setting.

After passing the speed limit sign

Press **OK** on the steering wheel.

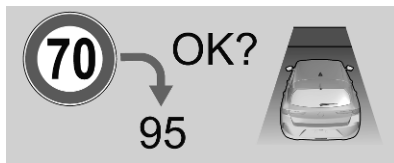

OK? is displayed

Press **OK** to store the suggested speed.

The suggested speed is shown as new speed setting.

Traffic sign assistant 175.

Exceeding the set speed

It is always possible to drive faster than the set speed by depressing the accelerator pedal. When the accelerator pedal is released, the vehicle returns to the stored speed. If a slower moving vehicle is ahead, the following distance selected by the driver is restored.

While the set speed is exceeded, the set speed flashes on the adaptive cruise control screen.

Warning

Accelerating by the driver deactivates automatic braking by the system. This is indicated as a pop-up warning in the Driver Information Centre.

Resuming stored speed

Press **||▶** or **OK** to reactivate the adaptive cruise control at the stored speed.

Adaptive cruise control on vehicles with automatic transmission

For vehicles with automatic transmission, the adaptive cruise control allows to maintain the selected distance behind a braking vehicle until a complete stop is reached.

If the system has stopped your vehicle behind another vehicle, the green control indicator (A) is displayed to the left of the set speed setting. This symbol notifies, that the vehicle is hold automatically in stop position.

While the vehicle is hold in stop position, the following recommendations should be followed:

- Do not leave the vehicle.
- Do not open the load compartment.
- Do not engage the reverse gear.
- Do not drop off or pick up passengers.

Within three seconds after the vehicle has been stopped by the system, the vehicle slowly moves again. After three seconds, accelerate or depress (A) to drive away. Pay attention to the surroundings of the vehicle when driving away.

If the vehicle stays stopped for more than five minutes without any action of the driver, the electric parking brake is applied. Control indicator (P) will illuminate. To release electric parking brake, press the accelerator pedal.

Electric parking brake ⇨ 143.

Warning

When the system is deactivated or cancelled, the vehicle will no longer be held at a stop and can start moving. Be always prepared to manually apply the brake to hold the vehicle stationary.

Do not leave the vehicle while it is being held at a stop by adaptive cruise control. Always move

selector lever to park position P and switch off the ignition before leaving the vehicle.

Setting the following distance

When the adaptive cruise control detects a slower moving vehicle in the driving path, it will adjust the vehicle speed to maintain the following distance selected by the driver.

The following distance can be set to close (1 bar), normal (2 bars) or far (3 bars).

If the engine is running and the adaptive cruise control is switched on (grey) or active (green), you can modify the following distance setting:



Press the button to display the current following distance setting in the Driver Information Centre.

Press the button successively to select the required following distance setting. The selected following distance is indicated by full bars on the adaptive cruise control screen.

Warning

The driver accepts full responsibility for the appropriate following distance based on traffic, weather and visibility conditions. Following distance must be

adjusted or the system switched off when required by the prevailing conditions.

Detecting the vehicle ahead



If the system detects a vehicle in the driving path, the adaptive cruise control screen changes accordingly.

Deactivation of the functionality

Press **||▶**.

The adaptive cruise control is deactivated, but not disabled. The last stored set speed remains in memory for later usage.

The adaptive cruise control is deactivated automatically in the following cases:

- brake pedal depressed
- traction control system or electronic stability control is operating
- reverse gear engaged, **N** selected or no gear engaged
- speed falls below 19 mph for a vehicle with manual transmission
- risk of engine stalling in case of a vehicle with manual transmission
- clutch pedal depressed for more than ten seconds
- electric parking brake engaged
- seat belt unfastened
- driver's door opened

Switching off the system

Press **ASSIST** successively until the desired mode to switch off assistance is selected.

Driver's attention

- Use the adaptive cruise control carefully on bends or mountain roads, as it can lose the vehicle ahead and needs time to detect it again.
- Do not use the system on slippery roads as it can create rapid changes in tyre traction (wheel spinning), so that you could lose control of the vehicle.
- Do not use the adaptive cruise control during rain, snow or heavy dirt, as the radar sensor can be covered by a water film, dust, ice or snow. This reduces or suppresses completely the visibility. In case of sensor blockage, clean the sensor cover.
- Do not use the system when the spare wheel is in use.

System limits

⚠ Warning

The system's automatic brake force does not permit hard braking and the braking level may not be sufficient to avoid a collision.

- After a sudden lane change, the system needs a certain time to detect the next preceding vehicle. So if a new vehicle is detected, the system may accelerate instead of braking.
- The adaptive cruise control does ignore the oncoming traffic.
- The adaptive cruise control does not consider pedestrians, cyclists and animals for braking and driving off.
- The adaptive cruise control does not consider stationary vehicles.

As the radar's field of detection is quite narrow, it is possible that the system may not detect:

- vehicles of reduced width, e.g. motorcycles, scooters
- vehicles not running in the middle of the lane
- vehicles entering a corner
- vehicles suddenly pulling out

Deactivate the system in the following situations:

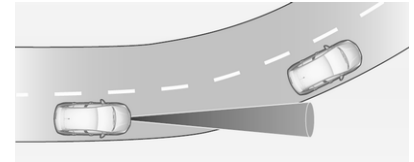

- when driving in a tight bend
- when approaching a roundabout
- when following a vehicle not detected by system, e.g., a motorcycle
- when the vehicle ahead sharply decelerates
- when a vehicle cuts in sharply between your vehicle and the vehicle ahead

Hill considerations

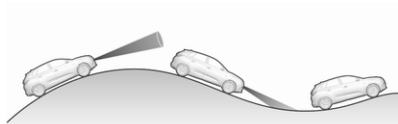

⚠ Warning

Do not use the adaptive cruise control on steep hill roads.

System performance on hills depends on vehicle speed, vehicle load, traffic conditions and the road gradient. It may not detect a vehicle in your path while driving on hills. On steep hills, you may have to use the accelerator pedal to maintain your vehicle speed. When going downhill you may have to brake to maintain or reduce your speed.

Note that applying the brake deactivates the system.

Radar unit



The radar unit is located in the middle of the front bumper.

⚠ Warning

The radar unit was aligned carefully during manufacture. Therefore, in the event of a front-end impact, do not use the system. The front bumper may appear to be intact, however the sensor behind may be affected and react incorrectly. After an accident, consult a workshop to verify and adjust the radar unit position.

⚠ Warning

The usage of a license plate support on the front bumper may affect the proper radar unit functionality.

When using a license plate support, follow the markings and indications on the front bumper.

Fault

In the event of an adaptive cruise control fault, a warning light is illuminated in the Driver Information Centre and a warning message is displayed in the Driver Information Centre accompanied by an audible signal.

The speed limit recognition may not operate correctly if traffic signs do not comply with the Vienna Convention on Road Signs and Signals.

Have the system checked by a workshop.

As a safety measure, do not use the system if the brake lights are faulty. Do not use the system if the front bumper is damaged.

Active emergency braking

Active emergency braking can help to reduce the damage and injury from a crash with a preceding vehicle, with a cyclist or with a pedestrian when the driver does not actively take action either by manual braking or by steering. Before active emergency braking applies, the driver is warned by the forward collision alert.

The system includes the following functions:

- forward collision alert
- smart brake assist
- automatic emergency braking

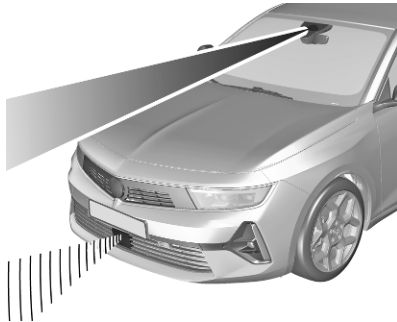

The system uses a camera located at the top of the windscreen and depending on version a radar unit located in the front bumper to calculate the probability of a frontal collision.

Warning

This system is not intended to replace the driver responsibility for driving the vehicle and looking ahead. Its function is limited to supplemental use only to reduce the vehicle speed before a collision.

The system may not react to animals. After a sudden lane change, the system needs a certain time to detect the next preceding vehicle.

The driver must always be ready to take action and apply the brakes and steer to avoid collisions.

Activating / deactivating the system

Active emergency braking is activated / deactivated in the Info Display.



Press  and activate / deactivate the system in the Info Display.

Info Display  86.

If deactivated,  illuminates in the Driver Information Centre. When ignition is switched on next time, the system is activated by default.

Functionality

When a moving vehicle has been detected, active emergency braking operates from 6 mph to 53 mph for vehicles with camera, from 6 mph to 87 mph for vehicles with camera and radar.

When a stationary vehicle, a cyclist or a pedestrian has been detected, active emergency braking operates if the vehicle speed does not exceed 50 mph.

Forward collision alert

The forward collision alert warns the driver if there is a risk of collision with the vehicle ahead, with a cyclist or a pedestrian.

Alerting the driver

The driver is warned by following alerts:

- Level 1: A warning message is displayed in the Driver Information Centre, when the distance to the vehicle ahead gets too small.

- Level 2: A warning message is displayed in the Driver Information Centre and a warning chime sounds, when a collision is imminent and immediate driver's action is required.
- Level 3: Depending on version, the vehicle may produce a short brake jerk to confirm the risk of collision. The immediate driver's action is required.

Warning

When approaching a vehicle ahead too rapidly, a level 2 alert may be displayed without a level 1 alert before.

Level 1 alerts depend on the alert sensitivity set. This alert type is only displayed in case of moving vehicles. At lower speed it is disabled.

Selecting the alert sensitivity

Notice

If the alert sensitivity setting with the longest distance is set, the system warns earlier. This increases the

safety, but increases the amount of alerts if the legal safety distance is not kept. To reduce the number of alerts, select a shorter alert sensitivity setting.

Three alert sensitivities can be selected in the driver assistance systems menu.

Vehicle personalisation ⇨ 91.

The chosen setting will be memorised when the ignition has been switched off. The alert sensitivity will vary based on selected alert setting.

Smart brake assist

If the driver brakes, but not sufficiently to avoid a collision, this system will supplement the braking. This assistance will only be provided if the driver presses the brake pedal.

Smart brake assist will automatically disengage when the brake pedal is released.

Automatic emergency braking

This function intervenes after the warning chime if the driver does not operate the brake pedal quickly

enough. The system tries to reduce the impact speed of the collision or to avoid a collision if the driver fails to react.

If automatic emergency braking is applied,  flashes in the Driver Information Centre.

Below a speed of 19 mph, automatic emergency braking may slow down the vehicle to a complete stop. Else, the speed will be reduced by a maximum of 16 mph. For versions with camera and radar, the speed reduction may be extended to 31 mph if both sensors are able to detect the hazard.

The driver must apply the brake to come to a complete stop.

- Automatic transmission: If the vehicle comes to a complete stop, automatic emergency braking is maintained for a

certain time. Keep the brake pedal depressed to prevent the vehicle from starting off again.

- Manual transmission: If the vehicle comes to a complete stop, the engine may stall. Keep the brake pedal depressed to prevent the vehicle from rolling.

Cruise control and adaptive cruise control will be deactivated when an emergency automatic braking occurs.

Warning

Do not rely on the system to brake the vehicle. Automatic emergency braking will not brake outside of its operating speed range and only responds to detected vehicles and pedestrians.

- the corresponding turn light is activated in advance
- the vehicle speed is between 3 mph and 12 mph
- the vehicle is about to cross the driving path of another vehicle

- the vehicle speed is between 3 mph and 50 mph
- the pedestrian has been enough time in the capturing fields of the sensors
- visibility is sufficient for the sensors to detect the pedestrian

Operation conditions

The system requires the following operating conditions:

- vehicle moving forward without trailer
- brake system operational
- Electronic Stability Control and Traction Control activated
- seat belts fastened on all seats
- constant speed on roads with no or low curvature

System limitations

The system is automatically deactivated in the following situations:

- diameter of the spare wheel too small
- fault with the brake pedal or with a brake light detected
- fault in the sensors, in the electronic or in the brake system detected
- trailer with an electrical plug connection detected
- following an impact (e.g. collision). Have the system checked by a workshop.

We recommend to deactivate the system in any situation in which the ignition is switched on and active emergency braking represents a risk such as:

- carrying long objects on roof bars
- using an automatic car wash
- placing the vehicle on a roller bench in a workshop
- towing the vehicle

- following an impact to the windscreen close to the camera
- following a front bumper deformation, e.g. during parking
- attaching a trailer, particularly trailers without own braking system
- driving with snow chains



Fault



If the system is not available due to system limits or operating conditions,  illuminates in the Driver Information Centre.

In certain cases,  illuminates accompanied by a message that the sensor is blind. For vehicle equipped only with camera, the system is deactivated. For systems equipped with camera and radar, the system may operate in a degraded mode. This may be caused by reduced visibility due to weather conditions or by an actual blockage of the sensor. In this case, verify whether the camera or the radar unit are blocked by dirt or other foreign objects.

In rare cases such as sensor initialisation, board voltage out of regular range etc., the system may not be available or may operate in a degraded mode. This is not indicated to the driver.

If a fault occurs,  illuminates, a message indicating the fault is displayed and an audible signal is given. Seek the assistance of a workshop.

If  and  are displayed after having the engine switched off and restarted, seek the assistance of a workshop.

If at least one seat belt of the front seats is not fastened,  and  illuminate. The system is deactivated until all seat belts are fastened.

Vehicle messages ⇨ 89.

Automatic post collision braking

If an accident is detected, the vehicle requests automatic post collision braking. The goal of this function is to reduce the risk of further collisions if

the driver does not react. The automatic post collision braking is not operational if the capability of the vehicle to trigger and execute the automatic post collision braking is unavailable, as it can occur in destructive accidents or in other specific accident scenarios.



It is possible to override the automatic braking by pressing the accelerator pedal or the brake pedal.

System limitations

The system operates if the following conditions are fulfilled:

- airbags or seat belt pretensioners have been deployed by the collision
- braking system and electric functions remain continuously operational during and after collision
- driver has not depressed brake pedal or accelerator pedal

Fault

If automatic post collision braking is not available, the control indicator  or  illuminates continuously, a corresponding message appears in the Driver Information Centre and a warning chime sounds.

Have the cause of the fault remedied by a workshop.

Curve speed adaptation

The system adapts the vehicle speed within its lane before entering a curve or when already driving in the curve. The vehicle speed is only adapted if it is too fast for the angle of the curve. If a vehicle is ahead, the following distance to this vehicle is maintained.

The driver can overrule the system by depressing the brake pedal or the accelerator pedal:

- Depressing the accelerator pedal temporarily pauses the function.
- Depressing the brake pedal deactivates the function.

Warning

The system does not adapt the vehicle speed in curves which are too tight, e.g. hairpin curves.

Operation conditions

Curve speed adaption is ready to operate if the following conditions are met:

- The vehicle speed is between 43 mph and 112 mph.
- The **Drive Assist** is activated.
- The vehicle is driving on road with separate carriageways a such as a motorway or expressway.

Activation

Curve speed adaption is activated via **Drive Assist**.



Press  and activate **Drive Assist** in the Info Display.



Press  at the steering wheel successively until the **Drive Assist** mode is selected.

The **Drive Assist** screen is displayed in the Driver Information Centre.

Info Display ⇨ 86.

Operation

The system monitors the curves. If it detects that the current vehicle speed is not compatible with the angle of the curve, it adapts the speed gradually.

Deactivation

Press  successively until the mode to switch off assistance is selected.

Parking assist

General information

Warning

The driver bears full responsibility for the parking manoeuvre.

Always check the surrounding area when driving backwards or forwards while using parking assist system.

Front-rear parking assist

The front-rear parking assist measures the distance between the vehicle and obstacles in front and behind the vehicle. It warns of objects in the vehicle's direction and in the detection zone of the sensors by giving acoustic signals and display indication.

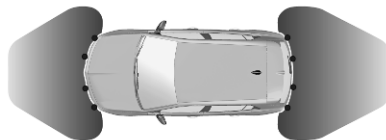

The system operates with ultrasonic parking sensors in the rear and front bumper.

Activation



Press  and activate **Close Obstacle Detection**.

Once activated, the system is ready to operate when P_{OFF}^{PWA} is not shown in the Driver Information Centre.

The front parking assist is triggered when an obstacle is detected in front and the speed of the vehicle is below 6 mph. The rear parking assist is triggered, when the reverse gear is engaged.

Indication

As soon as an obstacle gets closer to the vehicle, you will hear acoustic warning signals.

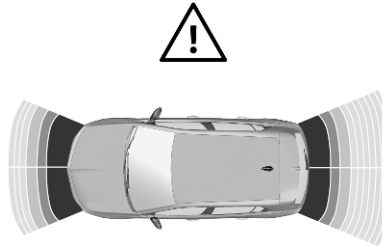

The interval between the sounds becomes shorter as the vehicle gets closer to the obstacle in the driving direction. When the distance is less than approx. 30 cm, the sound is continuous.

Deactivation

The system is deactivated automatically if vehicle speed exceeds 6 mph, the vehicle stops for

more than three seconds in a forward gear or the obstacle is no longer detected.

If the vehicle is electrically connected to a trailer, a bicycle carrier etc., the rear assist is automatically deactivated. In this case, the outline of a trailer is displayed at the rear part of the vehicle in the Driver Information Centre.

To manually deactivate the system, press  and deactivate the system in the Info Display. P_{OFF}^{PWA} will illuminate in the Driver Information Centre.

System limitations

In the event of a fault or if the system does not work temporarily, e.g. because of high external noise level or other interference factors,  illuminates in the Driver Information Centre, P_{OFF}^{PWA} illuminates in the Driver Information Centre, a message is displayed and a warning chime sounds.

Notice

Make sure that the front number plate is properly mounted, vertically and horizontally centred and the sensors are firmly in place. The performance of the parking assist will be reduced if the license plate is bent or a license plate support is used.

⚠ Warning

Under certain circumstances, various reflective surfaces on objects or clothing as well as external noise sources may cause the system to fail to detect obstacles.

Special attention must be paid to low obstacles which can damage the lower part of the bumper.

Caution

Performance of the system can be reduced when sensors are covered, e.g. by ice or snow.

Performance of the parking assist system can be reduced due to heavy loading.

Special conditions apply if there are taller vehicles in the vicinity (e.g. off-road vehicles, mini vans, vans). Object identification and correct distance indication in the upper part of these vehicles cannot be guaranteed.

Objects with a very small reflection cross-section, e.g. objects of narrow size or soft materials, may not be detected by the system.

Parking assist systems do not detect objects outside the detection range.

Side blind spot alert

The side blind spot alert system detects and warns of vehicles approaching from the rear in neighbouring lanes up to 75 m or of another vehicle in the blind spot of the vehicle.

The system displays a visual alert in each exterior mirror when detecting objects that may not be visible in the interior and exterior mirrors.

Side blind spot alert uses two radar sensors located in the rear bumper on each side of the vehicle.

⚠ Warning

Damage or scratches on the vehicle surface near the radar sensors may affect the performance of the system. This can cause wrong warnings or the loss of warnings.

Seek the assistance of a workshop.

⚠ Warning

Side blind spot alert is only a lane changing aid and does not replace driver vision.

Side blind spot alert does not detect:

- Vehicles approaching very rapidly.
- Pedestrians or animals.
- Non-moving objects, e.g. stationary vehicles, street lights, road signs, etc.

Failure to use proper care when changing lanes may result in damage to the vehicle, injury, or death. Always check the outside and rearview mirrors, glance over your shoulder, and use the turn signal before changing lanes.

Activation



Press  and activate / deactivate the system in the Info Display.

When the system is activated and the engine is switched on, the LEDs in each exterior mirror come on to indicate the system's activation.

Info Display  86.

Functionality

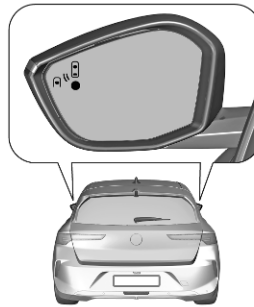

When the system detects a vehicle in the side blind zone while driving forwards, an LED will illuminate in the relevant exterior mirror. If the turn lights of the relevant side are activated, the LED will flash.

The LED comes on immediately when your vehicle is being passed.

The LED comes on after a delay when your vehicle is passing another vehicle slowly.

Operation conditions

The following conditions have to be fulfilled:

- all vehicles moving in the same direction and in adjacent lanes
- passing a vehicle with a speed difference of less than 9 mph
- normal traffic flow
- vehicle not pulling a trailer
- sensors not covered by mud, ice, snow etc.
- LEDs in the door mirrors or the rear radars not covered with stickers or other objects

No alert will be given in the following situations:

- non-moving objects, e.g. parked vehicles, barriers, street lamps, road signs
- in very dense traffic, when moving vehicles might be confused with a stationary object
- vehicles moving in the opposite direction
- passing too quickly

The function will not work properly due to adverse weather conditions such as heavy rain, damage of the surface near the radar sensor or when the sensors are covered with mud / dirt from the road.

Caution

If the rear bumper is to be repainted or repaired, contact a workshop. Certain types of paint could interfere with the operation of the radars.

Deactivation

Press  and deactivate the system in the Info Display.

The system is automatically deactivated when the vehicle is electrically connected to a trailer, bicycle carrier, etc.

Fault

In the event of a fault,  illuminates in the instrument panel and a message is displayed. Seek the assistance of a workshop.

Panoramic view system

This system allows views of the vehicle's surroundings to be displayed as a full 360° picture in the Info Display, like a bird's eye view.

Warning

The panoramic view system does not replace driver vision. It will not display children, pedestrians, cyclists, crossing traffic, animals, or any other objects outside of the

camera view area, e. g. below the bumper, or underneath the vehicle.

Do not drive or park the vehicle using only the panoramic view system.

Always check the surrounding of the vehicle before and during driving.

Displayed images may be further or closer than they appear. The area displayed is limited and objects that are close to either edge of the bumper or under the bumper are not displayed on the screen.

The system uses:



- rear camera



- front camera

- two side cameras in the exterior mirrors
- ultrasonic parking sensors in the bumpers

Visualisation on the Info Display

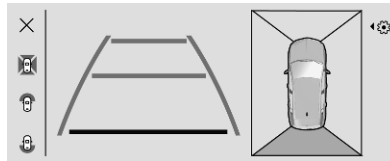

The screen is divided into four areas, from left to right:

- selectable views: standard, panoramic front, panoramic rear
- view visualisation
- top view including four selectable side views (in standard view only)
- settings ⚙️

The parking sensors complete the information on the view from above the vehicle.

Activation

The panoramic view system is activated by:

- engaging the reverse gear when the engine is switched on
- manual activation in the Info Display when the vehicle speed is below 10 mph

Info Display ⇨ 86.

Functionality

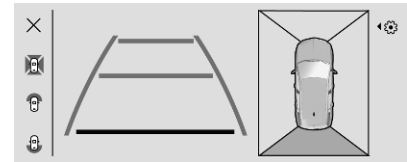

Different views can be selected in the left part of the display. Change the type of view at any time during a manoeuvre by selecting a view from the left side:

- standard view
- panoramic view
- side view

The display is immediately updated with the type of view selected.

By default, the zoom view is enabled. This setting can be changed in the settings of the panoramic view system in the Info Display.

The state of the system is kept in memory when the ignition is switched off.

Standard view

The standard view consists of a rear view and a front view.

Rear view

The area behind the vehicle is displayed in the screen. The vertical lines represent the width of the vehicle with mirrors unfolded. The direction of the lines changes with the steering angle.

The first horizontal line represents a distance of about 30 cm beyond the edge of vehicle's rear bumper. The upper horizontal lines represent distances of about 1 m and 2 m.

This view is available in auto mode or can be chosen from the left side of the screen.

Front view

The area in front the vehicle is displayed in the screen. The vertical lines represent the width of the vehicle with mirrors unfolded. The direction of the lines changes with the steering angle.

The first horizontal line represents a distance of about 30 cm beyond the edge of vehicle's front bumper. The upper horizontal lines represent distances of about 1 m and 2 m.

This view is displayed automatically or can be chosen from the left side of the screen.

Panoramic view

The panoramic view facilitates leaving a parking bay, making it possible to see the approach of vehicles, pedestrians and cyclists. This view is not recommended for carrying out a complete manoeuvre. This view can only be selected from the left side of the screen.

Side view

This view allows to view the surroundings, e.g. a pavement, a low wall, the vehicle parked to the next etc. on the left-hand or right-hand side of the vehicle.

Select the standard view and touch the required side of the vehicle. The selected side is highlighted and the side view is displayed.

Zoom view

The zoom view cannot be selected. It is only displayed if the distance between the vehicle and the obstacle is less than 60-80 cm.

The zoom provides a view from above the rear or the front of the vehicle in its near surroundings. Thus, the vehicle can be manoeuvred around obstacles nearby.

The automatic display of the zoom view can be disabled in the Info Display:

Press  below the Info Display and select **Panoramic camera**.

Press .

Activate **View Adaptation**.

The setting is memorised when the ignition is switched off.

Settings

The following settings can be adjusted:

- volume of the audible signal
- brightness
- contrast

Deactivation

Panoramic view system is deactivated when:

- driving faster than 10 mph in forward gear
- by pressing the icon **X** in the left upper corner of the touch screen

System limitations

Caution

For optimal operation of the system, it is important to keep the lenses of all cameras always clean. For the rear view camera,

there is a washer nozzle which will be activated when the rear window washer is operating.

If manually cleaning the lenses of the cameras, rinse the lenses with water and wipe with a soft cloth.

Do not clean the lenses with a steam-jet or high-pressure jet cleaner.

The panoramic view system may not operate properly when:

- The surrounding is dark.
- The sun or the beam of headlights is shining directly into the camera lenses.
- Weather limits visibility, such as fog, rain, or snow.
- The camera lenses are blocked by snow, ice, slush, mud, dirt.
- The vehicle is towing a trailer.
- The vehicle had an accident.
- There are extreme temperature changes.

Rear view camera

The rear view camera assists the driver when reversing by displaying a view of the area behind the vehicle. It allows views of the vehicle's surroundings to be displayed as a nearly 180° picture in the Info Display, like a bird's eye view.

Warning

The rear view camera does not replace driver vision. Note that objects that are outside the camera's field of view and the parking assist sensors, e.g. below the bumper or underneath the vehicle, are not displayed.

Do not reverse or park the vehicle using only the rear view camera.

Always check the surrounding of the vehicle before and during driving.

The system uses:



- rear view camera, mounted in the rear bumper above the number plate
- ultrasonic parking sensors in the rear bumper

The screen in the Info Display is divided into three parts:

- On the right side, there is a view from above the vehicle.
- The middle part consists of a contextual view.
- The left side consists of the view selection as well as the settings menu.

The parking sensors complete the information on the view from above the vehicle.

The area displayed by the rear view camera is limited. Displayed images may be further or closer than they appear.

The system automatically selects the best view to display according to the information from the parking sensors. The state of the system is not kept in memory when the ignition is switched off.

Activation

The rear view camera is activated when the reverse gear is engaged.

Functionality

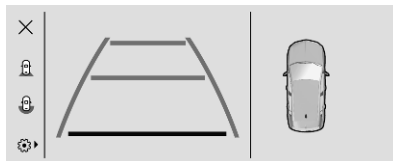

Different views can be selected in the left part of the display.

Change the type of view at any time during a manoeuvre by selecting the required view from the view selection in the left part of the Info Display:

- Standard view
- 180° view

The display is immediately updated with the type of view selected.

Using the camera, the vehicle's close surroundings are recorded during low speed manoeuvres. An image from above the vehicle in its close surroundings is created in real time (on the side of the screen), as the vehicle progresses. This view makes it easier to align the vehicle when parking and to perceive nearby obstacles. It is automatically deleted if the vehicle remains stationary for too long.

Standard view

The area behind the vehicle is displayed in the screen. The vertical lines represent the width of the vehicle with mirrors unfolded. The direction of the lines changes with the steering angle.

The first horizontal line represents a distance of about 30 cm beyond the edge of vehicle's rear bumper. The upper horizontal lines represent distances of about 1 m and 2 m.

This view is displayed automatically or can be chosen from the view selection.

Trajectory lane of the vehicle is shown in accordance with the steering angle.

180° view

The 180° view facilitates reversing out of a parking bay, making it possible to see the approach of vehicles, pedestrians and cyclists. This view is not recommended for carrying out a complete manoeuvre.

Zoom view

The rear view camera records the vehicle's surroundings during the manoeuvre in order to reconstruct a view from above the rear or the front of the vehicle in its near surroundings. An image from above the vehicle in its close surroundings is created as the vehicle progresses. Thus, the vehicle can be manoeuvred around obstacles

nearby. Zoom view cannot be manually selected. It is automatically activated if the distance between the vehicle and the obstacle is approx. 60-80 cm.

Settings menu

The settings menu allows to adjust the following settings:

- volume of the audible signal
- brightness
- contrast

Deactivation

The rear view camera is deactivated when:

- driving faster than 6 mph in a forward gear
- by pressing the icon **X** in the left upper corner of the touch screen

System limitations

Caution

For optimal operation of the system, it is important to keep the lense of the camera, which is located between the number plate lights, always clean. The rear view camera can be cleaned by a washer nozzle which is automatically activated when the rear window washer is operating. To wipe away water drops from the lense, use a soft cloth.

Do not clean the lense with a steam-jet or high-pressure jet cleaner.

The rear view camera may not operate properly when:

- surrounding is dark
- sun or beam of headlights is shining directly into camera lenses
- weather limits visibility, such as fog, rain, or snow

- camera lenses blocked by snow, ice, slush, mud, dirt. Clean the lense, rinse with water, and wipe with a soft cloth
- vehicle is electrically connected to a trailer, bicycle carrier, etc.
- vehicle had a rear end accident
- extreme temperature changes

Rear cross traffic alert

Caution

The driver must monitor the surroundings before and during the whole manoeuvre. Drive slowly and carefully in reverse gear in case of reduced or no visibility.

It is possible that warnings are not given, are given too late or seem unjustified. Be prepared to react at any time to avoid an accident.

Notice

If repainting the rear bumper, consult a qualified workshop since certain types of paint could interfere with the operation of the radar units.

Additional to the side blind spot alert ↻ 166, rear cross traffic alert warns of cross traffic from left or right side when driving rearwards at a speed up to 6 mph. It warns of approaching objects such as vehicles, trucks, pedestrians, cyclists and motorcycles.

To monitor the area left and right behind the vehicle, the system uses two radar sensors located in the rear bumper on each side of the vehicle.

Activation / deactivation



Press  and activate / deactivate the system in the Info Display.
Info Display ↻ 86.

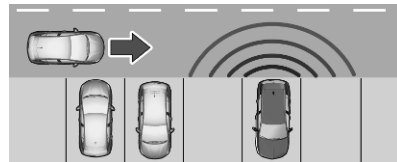

Detection zone

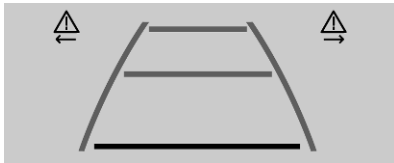

The system detects obstacles moving at speeds faster than 2 mph and at a maximum distance of 40 m.

Functionality



If an approaching obstacle is detected while the vehicle is in reverse gear,  or  flashes in the Driver Information Centre. In addition, an audible signal is given when the vehicle is moving backwards.

System limitations

The system may not operate properly in the following situations:

- towing trailer
- using a bicycle carrier on a towing device
- extreme temperature changes
- the rear bumper damaged
- accumulation or projection of external elements (e.g. mud, ice, snow), application of stickers.

Fault

In the event of a fault,  appears in the Driver Information Centre, accompanied by a message and a warning chime. Seek the assistance of a workshop.

Traffic sign assistant

Speed limit

Using the camera at the top of the windscreen and the speed limit information of the vehicle's navigation system, this system detects and reads speed limit signs and end of speed limit signs. Up to two speed limit signs including supplementary signs are displayed in the Driver Information Centre. If several speed limits are recognised, the vehicle may analyse and display the valid speed limit.

When a traffic sign for a certain area, e.g. city or motorway, is recognised and the vehicle is fitted with integrated navigation, the corresponding speed limit will also be displayed.

If the system is activated but does not detect a speed limit sign, the following sign is displayed:

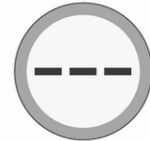

If a speed limit is detected and the vehicle exceeds it for the first time by more than 3 mph, the speed is displayed and flashes about ten seconds.

Speed limiter  150.

Cruise control  148.

Adaptive cruise control  152.

Activation

The speed limit function of the traffic sign assistant is activated via the **Drive Assist**.



Press  below the Info Display and activate **Drive Assist**.



Press  at the steering wheel successively until the **Drive Assist** mode is selected.

The **Drive Assist** screen is displayed in the Driver Information Centre.

Info Display ⇨ 86.

Deactivation



Press  successively until the mode to switch off assistance is selected.

Other traffic signs

The system recognises traffic signs and displays them in the Driver Information Centre.



Warning

The actual traffic sign always takes priority over the traffic sign displayed in the Driver Information Centre.

If the entry of a lane is forbidden by the corresponding traffic sign and the vehicle enters the lane in the wrong direction, the traffic sign and a message is displayed in the Driver Information Centre.

Activation / deactivation

Press  and activate / deactivate the system in the Info Display.

System limitations

Traffic sign assistant may not operate properly when:

- Driving on winding or hilly roads.
- During nighttime driving.
- Driving with snow chains.
- Driving with a trailer.
- The area of the windscreen, where the front camera is located, is not clean or affected by foreign items, e.g. stickers.
- Weather limits visibility, such as fog, rain, or snow.
- The sun is shining directly into the camera lens.
- Traffic signs are completely or partially covered or difficult to discern.
- Traffic signs are incorrectly mounted or damaged.
- Traffic signs do not comply with the Vienna Convention on Road Signs and Signals.
- The navigation map data is outdated.

Caution

The system is intended to help the driver within a defined speed range to discern certain traffic signs. Do not ignore traffic signs which are not displayed by the system.

The system does not discern any other than the conventional traffic signs that might give or end a speed limit.

Do not let this special feature tempt you into taking risks when driving.

Always adapt speed to the road conditions.

The driver assistance systems do not relieve the driver from full responsibility for vehicle operation.

Lane keep assist

Lane keep assist supports the driver to avoid unintended leaving of the lane. The front camera observes road edges, as well as the lane markings between which the vehicle is driving.

If the vehicle approaches a road edge or a lane marking, the steering wheel is gently turned to position so that the vehicle turns back into the lane. The driver will then notice a turning movement of the steering wheel. Turn steering wheel in same direction, if the system does not steer sufficiently. Turn steering wheel gently into opposite direction, if lane change is intended.

When the system steers to correct the trajectory of the vehicle,  flashes yellow in the Driver Information Centre.

Unintended lane departure is not assumed by the system when the turn lights are operated and during few seconds after turn lights have been switched off.

If the system detects that the steering wheel is not held permanently, it interrupts the correction. A warning message in the Driver Information Centre accompanied by a warning chime alerts when immediate driver's action is required.

Notice

The system may be switched off if it detects lanes which are too narrow, too wide or too curved.

Following preconditions have to be fulfilled:



- vehicle speed must be between approx. 43 mph and 112 mph
- the driver must hold the steering wheel
- the turn lights are not activated
- the electronic stability control is activated and not in operation
- the vehicle is not connected to a trailer or a bicycle carrier
- normal driving behaviour (system detects dynamic driving style, i.e. pressure on the brake or accelerator pedal)
- roads with good lane markings
- no spare wheel is used
- the vehicle is not driven in a tight corner

Activation / deactivation

The system is activated / deactivated in the vehicle settings  in the Info Display.

The system is automatically reactivated at the next vehicle start. Info Display  86.

Fault

In the event of a fault,  and  appear in the instrument panel, accompanied by a display message and a warning chime. Seek the assistance of a workshop.

System limitations

The system performance may be affected by:

- a dirty or foggy windscreen or if the windscreen is affected by foreign objects, e.g. stickers
- close vehicles ahead
- banked roads
- winding or hilly roads
- road edges
- sudden lighting changes

- adverse environmental conditions, e.g. heavy rain or snow
- vehicle modifications, e.g. tyres

Switch off the system if the system is disturbed by tar marks, shadows, road cracks, temporary or construction lane markings, or other road imperfections.

 Warning

Always keep your attention on the road and maintain proper vehicle position within the lane, otherwise vehicle damage, injury or death could occur.

Lane keep assist does not continuously steer the vehicle.

The system may not keep the vehicle in the lane or give an alert, even if a lane marking is detected.

The steering of the lane keep assist may not be sufficient to avoid a lane departure.

The system may not detect hands-off driving due to external influences like road condition and surface and weather. The driver has full responsibility to control the vehicle and is always required to keep the hands on the steering wheel while driving.

Using the system while towing a trailer or on slippery roads could cause loss of control of the vehicle and a crash. Switch the system off.

Advanced lane keep assist

Warning

The system assists the driver in managing the steering, acceleration and braking within the limits of the laws of physics and the capabilities of the vehicle. Some road infrastructure elements or vehicles present on the road may not be properly seen or may be poorly interpreted by the camera, which may lead to an unexpected change in direction, a

lack of steering correction and/or inappropriate management of the acceleration or braking.

Advanced lane keep assist is an enhancement of the lane keep assist system.



The activated system observes the lane markings by using the camera located at the top of the windshield. It steers the vehicle inside the detected lane. The driver will notice a turning movement of the steering wheel.

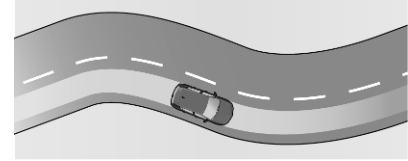

Thus, the current position of the vehicle within the lane is kept. This position is not necessarily the centre of the lane.

In the case that the vehicle is driving at the outer edge of the lane, the system corrects the trajectory smoothly towards the centre of the currently driven lane when a determined speed has been exceeded. Again, the driver will notice a turning movement of the steering wheel.

When the vehicle is steered by the system,  illuminates green in the Driver Information Centre.

However, the control of the vehicle can be taken over at any time by the driver. Therefore, the driver needs to apply some additional force when turning the steering wheel.

If the system detects that the driver is not holding the wheel firmly enough, it triggers a series of gradual alerts. If the interruption takes too long, the system will be deactivated.

 extinguishes in the Driver Information Centre. The system has to be reactivated again by the driver.

Advanced lane keep assist operates only in combination with adaptive cruise control.

Adaptive cruise control  152.

Required preconditions

- Adaptive cruise control must be activated.
- The driver must hold the steering wheel.
- The turn lights are not activated except when using with semi-automated lane change.
- The Electronic Stability Control is activated and not in operation.
- The vehicle is not connected to a trailer or a bicycle carrier.

- Normal driving behaviour is required (system detects dynamic driving style, i.e. pressure on the brake or accelerator pedal).
- Roads with good lane markings are required.
- No spare wheel is used.
- The vehicle is not driven in a tight corner.

Activation

Advanced lane keep assist is activated via the **Drive Assist**.



Press  and activate **Drive Assist** in the Info Display.



Press  successively until the **Drive Assist** mode is selected.

The **Drive Assist** screen is displayed in the Driver Information Centre.

Info Display  86.

Deactivation



Press  successively until the mode to switch off assistance is selected.

Pausing / suspending the system

Advanced lane keep assist may be paused or suspended in the following situations:

- The Electronic Stability Control is in operation or it has been deactivated.
- At least one of the lane markings is not detected by the system for several seconds. The system will be reactivated once the operating conditions are regained.
- The turn lights are not activated except when using with semi-automated lane change.
- Driving outside the lane limits.
- The steering wheel is held too tight or moved too dynamically.
- The brake pedal or the accelerator pedal is applied.
- The adaptive cruise control is paused.
- The road is too narrow or wide.
- The lateral acceleration in curves is too high.

Fault

In the event of a fault,  and  appear in the instrument panel, accompanied by a message and a warning chime. Seek the assistance of a workshop.

System limitations

The system performance may be affected by:

- dirty or foggy windscreen or if the windscreen is affected by foreign objects, e.g. stickers
- close vehicles ahead
- banked roads
- winding or hilly roads
- road edges
- sudden lighting changes
- adverse environmental conditions, e.g. heavy rain or snow
- vehicle modifications, e.g. tyres
- load condition of the vehicle, i.e., whether the vehicle heavily or lightly loaded

A warning message may appear when the vehicle is travelling in a long straight lane on a smooth road surface even if the driver is holding the steering wheel properly.

Deactivate the system if the system is disturbed by tar marks, shadows, road cracks, temporary or construction lane markings, or other road imperfections.

Warning

Always keep your attention on the road and maintain proper vehicle position within the lane, otherwise vehicle damage, injury or death could occur.

The system may not keep the vehicle in the lane or give an alert, even if a lane marking is detected.

The steering of the advanced lane keep assist may not be sufficient to avoid a lane departure.

The system may not detect hands-off driving due to external influences (road condition and surface, weather etc). The driver

has full responsibility to control the vehicle and is always required to keep the hands on the steering wheel while driving.

Using the system while towing a trailer or on slippery roads could cause loss of control of the vehicle and a crash. Switch the system off.

Semi-automated lane change

Semi-automated lane change assists the driver when changing lanes. It uses a camera at the top of the windscreen, a radar sensor located in the middle of the front bumper and four radar sensors located on the left and right side of the front and rear bumper.

⚠ Warning

Only initiate a semi-automated lane change if the traffic conditions allow a safe lane change.

Operation conditions

The following conditions have to be fulfilled:

- vehicle speed between 43 mph and 112mph
- adaptive cruise control activated
- advanced lane keep assist activated
- **Drive Assist** activated
- driving on a road with separate lanes
- lane markings can be clearly detected by the system
- traffic situation allows a safe lane change

Activation

Semi-automated lane change is activated via **Drive Assist**.



Press  and activate **Drive Assist** in the Info Display.



Press  at the steering wheel successively until the **Drive Assist** mode is selected.

The **Drive Assist** screen is displayed in the Driver Information Centre.

Info Display ⇨ 86.

To start a semi-automated lane change manoeuvre, activate the turn lights of required direction.

The semi-automated lane change can be interrupted by deactivating the turn light indicator or firmly holding the steering wheel.

Deactivation



Press  successively until the mode to switch off assistance is selected.

Functionality

If the turn light indicator has been set and the operation conditions are met, **OK?** is displayed in the Driver Information Centre and an audible signal is given.

Press **OK** on the steering wheel.

A message is displayed reminding the driver to be attentive. The vehicle is now steered to the target lane by small steering inputs.

Keep your hands at the steering wheel during the manoeuvre.

When the vehicle has been positioned in the target lane, the system is deactivated.

If the operation conditions are not met, the lane change manoeuvre is rejected. In this case, orange lines are displayed in the drive assist view and an audible signal is given.

A semi-automated lane change manoeuvre may be interrupted if the operating conditions are no longer met:

- If no wheel has crossed the lane marking, the system steers the vehicle back in its original lane.
- If the lane change manoeuvre is already in progress, the system prompts the driver to take back control of the vehicle.

In both situations, a message is displayed, an audible signal is given and the system is automatically deactivated.

System limitations

The system may not function in the following situations:

- driver wearing thick gloves
- poor visibility caused by insufficient road lighting, snowfall, rain, fog etc.
- dazzle (headlamps of an oncoming vehicle, low sun, reflections on a wet road surface, leaving a tunnel, alternating light and shade)

- windscreen area in front of the camera damaged or covered by dirt, stickers or other foreign objects
- lane markings eroded, partially hidden (snow, mud) or multiple (roadworks, surface joints)
- in a tight curve
- on winding roads
- road surface repairs

Never use the system in the following situations:

- towing or with a bicycle carrier on a towing device
- adverse weather conditions
- road with low grip (risk of aquaplaning, snow, ice)
- road works and toll areas
- on racing circuits
- on a rolling road

Driver alert

The driver alert system monitors the driving time and the vigilance of the driver. Monitoring the vigilance of the

driver is based on the trajectory variations of the vehicle compared to the lane markings.

The system cannot replace the need for vigilance on the part of the driver. Taking a break is recommended as soon as feeling tired or at least every two hours. Do not drive when feeling tired.

Activation or Deactivation

The system is activated / deactivated in the Info Display.



Press  and activate / deactivate the system in the Info Display .
Info Display ⇨ 86.

The system is automatically activated when ignition is switched on.

Driving time alert

The driver gets notified by a pop-up reminder symbol  in the Driver Information Centre simultaneously with an acoustic alert if the driver has not taken a break after two hours of driving at a speed above 43 mph. The alert is repeated hourly until the vehicle is stopped, no matter how vehicle speed evolves.

The counting of driving time alert is reset if one of the following conditions are met:

- The ignition has been switched off for a few minutes.
- The driver's seat belt is unfastened and the door at the driver's side is opened.

Driver drowsiness detection

The system monitors the driver's level of vigilance at speeds above 43 mph. A camera at the top of the windscreen detects variations in trajectory compared to the lane markings.

If the trajectory of the vehicle suggests a certain level of drowsiness or inattention by the driver, the system triggers the first level of alert. The driver is notified by a message and an audible signal is given.

After three first level alerts, the system triggers a new alert with a message, accompanied by a more pronounced audible signal.

In certain driving conditions such as poor road surface or strong winds etc., the system may give alerts independent of the driver's level of vigilance.

The driver drowsiness detection is reinitialised when the ignition has been switched off for a few minutes or the speed remains below 40 mph for a few minutes.

The system is also reinitialised when the driver's seat belt is unfastened and the door at the driver's side is opened.

System limitations

In the following situations, the system may not operate properly or even not operate at all:

- poor visibility caused by inadequate lighting of the roadway, falling snow, heavy rain, dense fog etc.
- dazzle caused by headlamps of oncoming vehicles, low sun, reflections on damp roads, leaving a tunnel, alternating shade and light etc.
- windscreen area in front of the camera covered by dirt, snow, stickers etc.
- no lane markings detected or multiple lane markings due to roadworks
- close vehicles ahead
- winding roads or narrow roads
- when advanced lane keep assist is active

Charging

General information

⚠ Warning

Persons with a pacemaker should consult a doctor for possible precautions.

Charging the vehicle's high voltage battery depends upon several factors:

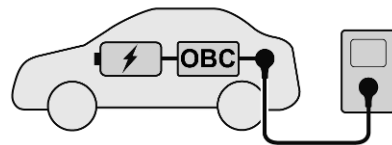

- high voltage battery of the vehicle
- internal onboard charger (OBC)
- external charging device
- charging cable

The charging cable connects the vehicle's high voltage battery with an external charging device providing electric power. This may be a

domestic electrical outlet, a Green'Up outlet, a wall box or a public charging station.

The high voltage battery can be charged with direct current (DC) only. When charging from a domestic electrical outlet, a wall box or an alternating current (AC) charging station, AC has to be converted into DC. This is done by the vehicle's onboard charger. The onboard charger (single-phase) is available with 3.7 kW or 7.4 kW.

The speed of charging the vehicle's high voltage battery depends upon the weakest element of the charging chain. To achieve the maximum charging speed, charging cable and charging device have to be attuned to each other.

Notice

Make sure that the charging cable used fits to the vehicle's onboard charger.

Charging types ⇨ 186.

Charging cable ⇨ 193.

Electric power consumption and range

The electric power consumption (combined under WLTP condition) is within a range of 15.6 to 14.6 kWh/100 km.

The all electric range is up to 38 miles.

For the values specific to your vehicle, refer to the EEC Certificate of Conformity provided with your vehicle or other national registration documents.

The determination of electric power consumption is regulated by directive R (EC) No. 715/2007 and No. 2017/1151 (in the latest applicable version).

Charging types

There are different types of charging the vehicle's high voltage battery. Charging times refers to charging an empty battery until it is completely charged.

Charging at wall boxes / AC charging stations

A wall box / AC charging station may or may not provide a charging cable which has to be connected to the vehicle's charging port.

Charging time takes approx. three hours and 25 minutes with the 3.7 kW onboard charger and 16 A. For the 7.4 kW onboard charger with 32 A, charging time takes approx. one hour and 40 minutes.

Charging at Green'Up outlets

The high voltage battery can be charged at a Green'Up outlet. Connect the charging cable to the vehicle's charging port and to the Green'Up outlet.

Charging time takes approx. three hours and 55 minutes.

Charging at domestic electrical outlets



The high voltage battery can be charged at a domestic electrical outlet. Connect the charging cable to the vehicle's charging port and to the domestic electrical outlet.

Charging time takes approx. seven hours and five minutes.

Charging cable

Depending on the charging type, different charging cables are used.

⚠ Warning

Improper use of portable charging cables may cause a fire, electrical shock, or burns, and may result in damage to property, serious injury, or death.

- Do not use extension cables, multi-outlet power strips, splitters, grounding adaptors, surge protectors, or similar devices.
- Do not use an electrical socket that is worn or damaged, or one that will not hold the plug firmly in place.
- Do not immerse the charging cable into any liquid.
- Do not use an electrical socket that is not properly grounded.
- Do not use an electrical socket that is on a circuit with other electrical loads.

⚠ Warning

Read all the safety warnings and instructions before using this product. Failure to follow the warnings and the instructions may result in electric shock, fire, and / or serious injury.

Never leave children unattended near the vehicle while the vehicle is charging and never allow children to play with the charging cable.

If the plug provided does not fit the electrical outlet, do not modify the plug. Arrange for a qualified electrician to inspect the electrical outlet.

Do not put fingers into the electric vehicle connector.

⚠ Danger

There is a risk of electric shock that may cause personal injury or death.

Do not use the charging cable if any part of the charging cable is damaged.

Do not open or remove the charging cable cover.

Service by qualified personnel only. Connect the charging cable to a properly grounded outlet with cables that are not damaged.

Basic domestic cable (mode 2) / enhanced domestic cable (mode 2)

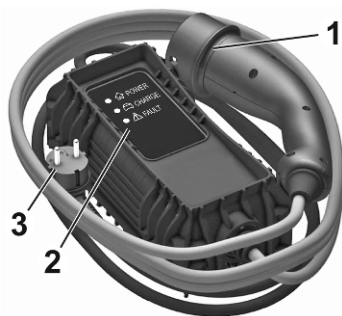

1. Vehicle plug
2. Status indicators
3. Wall plug

Basic domestic cables (mode 2) are used for charging at domestic electrical outlets. A basic domestic cable (mode 2) consists of a vehicle plug, a control box and a plug for the domestic electrical outlet. The control box has an intergrated charge controller and several LEDs indicating the charging status.

Enhanced domestic cables (mode 2) are similar to basic domestic cables (mode 2). However, the charging performance of enhanced domestic cables (mode 2 charging) is better than the charging performance of basic domestic cables (mode 2). Enhanced domestic cables (mode 2) are used at Green'Up sockets which have to be installed by a certified electrician at the customer's site.

Charging cable status indicators

After plugging in the charging cable, it will perform a quick self test and all status indicators illuminate for a moment. For the functions of the status indicators, refer to the manual of the charging cable manufacturer.

Important information about portable electric vehicle charging

- Charging an electric vehicle can stress a building's electrical system more than a typical household appliance.
- Before you plug in to any electrical outlet, have a qualified electrician inspect and verify the

electrical system (electrical outlet, wiring, junctions and protection devices) for heavy-duty service at a 10 A continuous load.

- Electrical outlets may wear out with normal usage or be damaged over time, making them unsuitable for electric vehicle charging.
- Check the electrical outlet / plug while charging and discontinue use if the electrical outlet / plug is hot, then have the electrical outlet serviced by a qualified electrician.
- When outdoors, plug into an electrical outlet that is weather-proof while in use.
- Mount the charging cable to reduce strain on the electrical outlet / plug.

Mode 3 charging cable



1. Vehicle plug
2. Plug for wall box / AC charging station

Mode 3 charging cables are used for charging at wall boxes and AC charging stations. A mode 3 charging cable provides a vehicle plug and a plug for the wall box / AC charging station. Wall boxes / AC charging stations may provide an integrated mode 3 charging cable. For more information on the mode 3 charging cable, refer to the manual of the charging cable manufacturer.

Charging

⚠ Warning

Persons with a pacemaker or similar devices should consult a doctor for possible precautions.

If in doubt, during charging do not remain inside or near the vehicle, near the charging cable or the charging unit.

In order to ensure the compatibility of plug and outlet, a label is used. The label is located on the inside of the vehicle's charging port flap. Make sure to connect only a cable of the same type.



Type 2 plug or outlet used for AC charging

When charging at a public AC charging station, follow the instructions for the use of the respective charging station. Public AC charging stations may not provide an integrated charging cable. In this case, a portable mode 3 charging cable is required.

⚠ Warning

When charging at a domestic electrical outlet, only use an outlet which is properly grounded and protected by a 30 mA differential switch.

Only use a domestic electrical outlet protected by a circuit breaker adapted to the amperage of the electrical circuit.

Have a qualified electrician check the electrical installation to be used. The installation has to be in compliance with national standards and compatible with the vehicle.

When using a dedicated domestic electrical outlet, have it installed by a qualified electrician.

Make sure that the electrical outlet, the plug and the cable do not support the weight of the control box.

⚠ Warning

The engine does not start if the charging cable is connected to the vehicle. A warning is displayed in the Driver Information Centre.

During the charging process, unlocking the vehicle will interrupt charging. If no action is taken on tailgate, the doors or the charging nozzle, the vehicle will lock again after 30 seconds and charging will resume automatically.

Do not work in the engine compartment. Some areas remain very hot, even an hour after charging and the fan may start at any time.

⚠ Warning

Make sure that the charging port flap is closed.

Do not leave the charging cable connected to the domestic electrical outlet.

1. Shift into **P** and switch off the vehicle.



2. Push the charging port flap to release it.
3. If necessary, take the charging cable out of the load compartment.

4. If necessary, plug in the plug of the charging cable into the corresponding port of the external power source.

Charging cable ⇨ 193.

5. If necessary, remove the protective cover from the vehicle plug of the charging cable.



6. Plug in the vehicle plug of the charging cable into the charging port of the vehicle.

Charging status ⇨ 192.

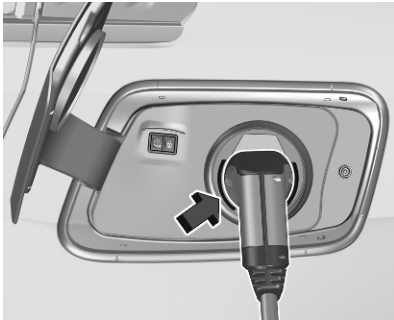

The start of charging is indicated by the green flashing of the status indicator at the charging port and at the control box of the charging cable if available.



Once charging, the vehicle plug will be locked to the charging port and cannot be disconnected while charging is active.  indicator illuminates.

Charging types ⇨ 186

Cancelling the charging process

Notice

At public charging stations, the cancelling and subsequent resuming of the charging process may cause additional costs.

Once the charging process has started, only the driver's door can be unlocked without cancelling the charging process. Therefore, activate the driver's door only function in the vehicle personalisation.

Press  on the remote control to cancel the charging process at any time.

Press  twice to cancel the charging process at any time if the function **driver's door only** is activated in the vehicle personalisation.

Central locking system ⇨ 10.

Vehicle personalisation ⇨ 91.

Stop charging

The high voltage battery is fully charged if the status indicator on the charging port permanently illuminates green.

1. Unlock the vehicle before removing the vehicle plug from the charging port.

If the vehicle is already unlocked, lock the vehicle and unlock it again.

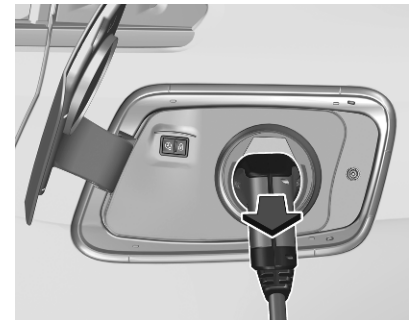

2. Disconnect the vehicle plug of the charging cable from the charging port within 30 seconds after unlocking.
3. Close the charging port flap by pressing firmly in the centre to latch properly.
4. Disconnect the charging cable from the external power source.
5. If necessary, store the charging cable in the load compartment.

While the charging cable is plugged into the vehicle, the vehicle cannot be driven.

Programmable charging

By default, charging starts as soon as the charging cable is connected to the charging port of the vehicle. It is also possible to schedule charging using the Info Display.

Programmable charging is only possible when charging at a domestic electrical outlet / Green'Up socket or a wall box.

Programmable charging is also available via the MyVauxhall App.



Notice

On vehicles without integrated navigation system, programmable charging can only be used via the MyVauxhall App.

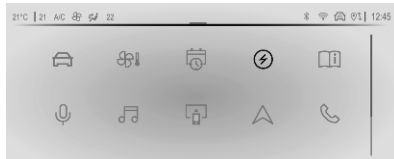

1. Press .



2. Touch .
3. Select **Charging**.
4. Touch .

5. Define the number of hours and minutes after which the loading process starts.
6. Touch **OK**.
7. Plug in the vehicle.



8. Within one minute, press  to activate programmable charging.
9. Depending on version, lock the vehicle.

The status indicator illuminates blue indicating that programmable charging is active.

Charging ⇨ 189.

Charging status ⇨ 193.

Charging status



If the vehicle is plugged in and the ignition is switched off, the charging status indicator indicates the following:

- Illuminates white: welcome lighting when charging port flap is opened
- Illuminates green: charging complete
- Flashes green: charging in process
- Illuminates blue: programmable charging active
- Illuminates red: malfunction

A malfunction may be caused by the vehicle or the electrical installation at the customer's site.

Further charging status indicators are located on the control box of the basic domestic cable (mode 2) / enhanced domestic cable (mode 2).

Charging cable ↗ 187.

Programmable charging ↗ 192.

Fuel

Fuel for petrol engines

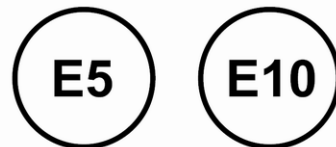

Only use unleaded fuel that complies with European standard EN 228 or E DIN 51626-1 or equivalent.

The engine is capable of running with fuel that contains up to 10% ethanol (e.g. named E10).

Use fuel with the recommended octane rating. A lower octane rating can reduce engine power and torque and slightly increases fuel consumption.

Notice

The only petrol additives authorised for use are those that meet the B715001 standard.

Caution

Do not use fuel or fuel additives that contain metallic compounds such as manganese-based additives. This may cause engine damage.

Caution

Use of fuel with a lower octane rating than the lowest possible rating could lead to uncontrolled combustion and engine damage.

The engine specific requirements regarding octane rating are given in the engine data overview ↗ 243. A country-specific label at the fuel filler flap can supersede the requirement. In certain countries, the use of a particular fuel, e.g. a specific octane rating, may be required to ensure proper engine operation.

Fuel for diesel engines

The Diesel engines are compatible with bio-fuels that conform to current and future European standards and can be obtained from filling stations:

B7

Diesel fuel that meets standard EN590 mixed with a biofuel that meets standard EN14214 (possibly containing up to 7% Fatty Acid Methyl Ester).

B10

Diesel fuel that meets standard EN16734 mixed with a biofuel that meets standard EN14214 (possibly containing up to 10% Fatty Acid Methyl Ester).

XTL

Paraffinic Diesel fuel that meets standard EN15940 mixed with a biofuel that meets standard EN14214 (possibly containing up to 7% Fatty Acid Methyl Ester).

B20**B30**

The use of B20 or B30 fuel meeting standard EN16709 is possible in your Diesel engines. However, this use, even occasional, requires strict

application of the special servicing conditions referred to as "Arduous conditions".

For more information, contact a workshop.

Caution

The use of any other type of (bio) fuel (vegetable or animal oils, pure or diluted, domestic fuel etc.) is strictly prohibited (risk of damage to the engine and fuel system).

Notice

The only Diesel additives authorised for use are those that meet the B715000 standard.

Low temperature operation

At temperatures below 0 °C, some diesel products with biodiesel blends may clog, freeze or gel, which may affect the fuel supply system. Starting and engine operation may not work properly. At ambient temperatures below 0 °C, use winter grade diesel fuel.

At temperatures below -15 °C, it is recommended to park the car in a heated garage.

Arctic grade diesel fuel can be used at extremely low temperatures below -20 °C. Using this fuel grade in warm or hot climates is not recommended and may cause engine stalling, poor starting or damage on the fuel injection system.

Refuelling

Danger

Before refuelling, switch off ignition and any external heaters with combustion chambers.

Follow the operating and safety instructions of the filling station when refuelling.

Danger

Fuel is flammable and explosive. No smoking. No naked flames or sparks.

If you can smell fuel in your vehicle, have the cause of this remedied immediately by a workshop.

A label with symbols at the fuel filler flap is indicating the allowed fuel types. In Europe the pump nozzles of the filling stations are marked with these symbols. Refuel only the allowed fuel type.

Caution

In case of misfuelling, do not switch on ignition.

The fuel filler flap is located at right rear side of vehicle.



The fuel filler flap can only be opened if the vehicle is unlocked. Release the fuel filler flap by pushing the flap.

To open the fuel filler flap of a hybrid vehicle, a depressurisation phase is required to avoid the emission of fuel vapour. This can take up to one minute.

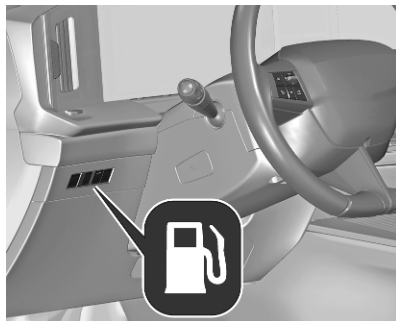

Press . After depressurisation the fuel filler flap is unlocked and bounces a bit.

Petrol and diesel refuelling

To open, turn the cap slowly anticlockwise.



The fuel filler cap can be attached to the hook on the fuel filler flap.

Place the nozzle in straight position to the filler neck and press with slight force to insert.

To refuel, switch on pump nozzle.

After the automatic cut-off, the tank can be topped up by operating the pump nozzle a maximum of two more times.

Caution

Wipe off any overflowing fuel immediately.

To close, turn the fuel filler cap clockwise until it clicks.

Close the flap and allow it to engage.

Fuel filler cap

Only use genuine fuel filler caps.

Diesel-engined vehicles have special fuel filler caps.

Fuel consumption - CO₂-Emissions

All values are combined values under WLTP condition.

Non-hybrid vehicle

The fuel consumption is within a range of 36 to 56 mpg.

The CO₂ emission is within a range of 148 to 111 g/km.

Hybrid vehicle

The fuel consumption is within a range of 196 to 235 mpg.

The CO₂ emission is within a range of 28 to 22 g/km.

General information

For the values specific to your vehicle, refer to the EEC Certificate of Conformity provided with your vehicle or other national registration documents.

The determination of fuel consumption is regulated by directive R (EC) No. 715/2007 and No. 2017/1151 (in the latest applicable version).

The specification of CO₂ emission is also a constituent of the directive.

The figures given must not be taken as a guarantee for the actual fuel consumption of a particular vehicle. Furthermore, fuel consumption is dependent on personal driving style as well as road and traffic conditions.

All values are based on the EU base model with standard equipment.

The calculation of fuel consumption takes into account the vehicle's kerb weight, ascertained in accordance with the regulations. Optional equipment may result in slightly

higher fuel consumption and CO₂ emission levels and a lower maximum speed.

Trailer hitch

General information

Caution
For new vehicles, only tow a trailer after having driven at least 620 miles.

Only use towing equipment that has been approved for your vehicle.

Entrust retrofitting of towing equipment to a workshop. It may be necessary to make changes that affect the cooling system, heat shields or other equipment.

Fitting of towing equipment could cover the opening of the towing eye. If this is the case, use the coupling ball bar for towing. Always keep the coupling ball bar in the vehicle to have it on hand if needed.

Driving characteristics and towing tips

Before attaching a trailer, lubricate the coupling ball. However, do not do so if a stabiliser, which acts on the coupling ball, is being used to reduce snaking movements.

During trailer towing do not exceed a speed of 50 mph. A maximum speed of 60 mph is only appropriate if an oscillation damper is used and the permissible gross trailer weight does not exceed the vehicle's curb weight.

For trailers with low driving stability and caravan trailers, the use of an oscillation damper is strongly recommended.

If the trailer starts snaking, drive more slowly, do not attempt to correct the steering and brake sharply if necessary.

When driving downhill, drive in the same gear as if driving uphill and drive at a similar speed.

Adjust tyre pressure to the value specified for full load ↗ 248.

Trailer towing

Trailer loads

The permissible trailer loads are vehicle and engine-dependent maximum values which must not be exceeded. The actual trailer load is the difference between the actual gross weight of the trailer and the actual coupling socket load with the trailer coupled.

The permissible trailer loads are specified in the vehicle documents. In general, they are valid for gradients up to 12%.

The permissible trailer load applies up to the specified incline and at sea level. Since engine power decreases as altitude increases due to the air becoming thinner, therefore reducing climbing ability, the permissible gross train weight also decreases by 10% for every 1000 m of altitude. The gross train weight does not have to be reduced when driving on roads with slight inclines (less than 8%, e.g. motorways).

The permissible gross train weight must not be exceeded. This weight is specified on the identification plate \rightarrow 240.

Vertical coupling load

⚠ Warning

If attaching accessories to the trailer hitch such as bicycle carriers, tow boxes etc., do comply with the maximum permissible vertical coupling load.

When using a bicycle carrier, do not transport more than four conventional bicycles or two electric bicycles. Make sure to place the heaviest bicycle as close as possible to the vehicle.

The vertical coupling load is the load exerted by the trailer on the coupling ball. It can be varied by changing the weight distribution when loading the trailer.

The maximum permissible vertical coupling load (55 kg) is specified on the towing equipment identification plate and in the vehicle documents.

Always aim for the maximum vertical coupling load, especially in the case of heavy trailers. The vertical coupling load should never fall below 25 kg.

Rear axle load

When the trailer is coupled and the towing vehicle fully loaded, the permissible rear axle load (see identification plate or vehicle documents) may be exceeded by 60 kg, the gross vehicle weight rating must not be exceeded. If the permissible rear axle load is exceeded, a maximum speed of 60 mph applies.

Towing equipment

Caution

When operating without a trailer, remove the coupling ball bar.

Stowage of coupling ball bar



The bag with the coupling ball bar is stowed on the rear floor cover in the load compartment.

Place the strap through the rear right lashing eye, wrap around twice and tighten the strap to secure the bag.

Fitting the coupling ball bar



Disengage and fold down the socket. Remove the sealing plug from the opening for the coupling ball bar and stow it.

Checking the tensioning of the coupling ball bar

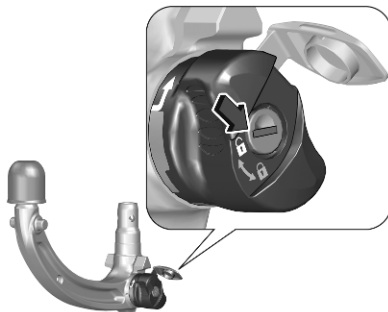

- Remove the protective flap of the lock of the rotary knob and verify whether the rotary knob is unlocked.

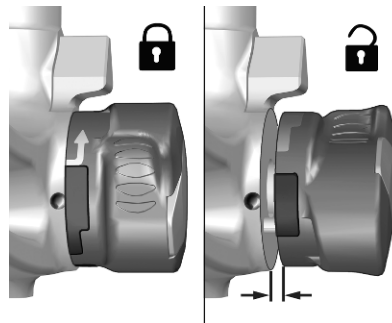

- Red marking on rotary knob must point towards white marking on coupling ball bar.
- The gap between the rotary knob and the coupling ball bar must be approx. 5 mm.

Otherwise, the coupling ball bar must be tensioned before being inserted:

- Unlock coupling ball bar by turning the key to position .

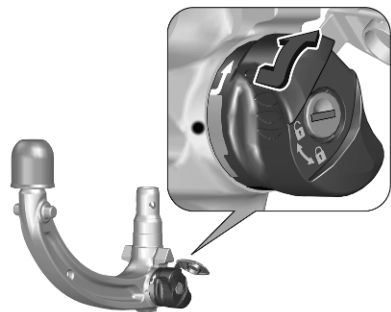

- Pull out the rotary knob and turn clockwise as far as it will go.

Inserting the coupling ball bar

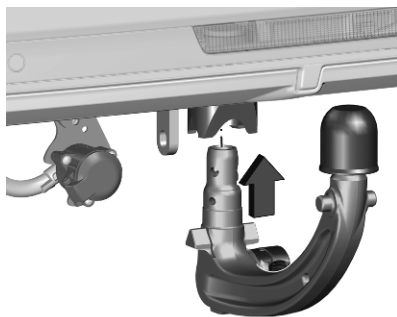

Insert the tensioned coupling ball bar in the opening and push firmly upwards until it audibly engages.

The rotary handle snaps back into its original position resting against the coupling ball bar without a gap.

⚠ Warning

Do not touch rotary handle during insertion.

Lock the coupling ball bar by turning the key to position . Remove the key and close the protective flap.

Eye for break-away stopping cable

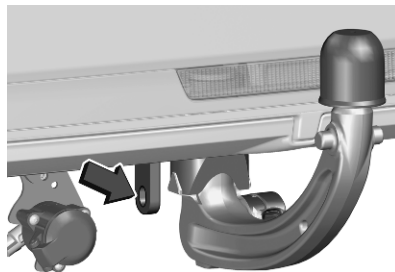

Attach the breakaway stopping cable to the eye.

Check that the coupling ball bar is correctly installed

- The green marking on the rotary knob must point towards the white marking on the coupling ball bar.
- There must be no gap between the rotary knob and the coupling ball bar.
- The coupling ball bar must be firmly engaged in the opening.
- The coupling ball bar must be locked and the key removed.

⚠ Warning

Towing a trailer is permitted only when a coupling ball bar is fitted correctly. If the coupling ball bar does not engage correctly, seek the assistance of a workshop.

Dismounting the coupling ball bar

Hold the plug of the trailer and disconnect it from the power outlet by performing a a quarter turn and pulling.

Disconnect the safety cable of the trailer from the safety eye of the carrier.

Remove the trailer from the coupling ball.

Put the protective cover over the towing ball.

Open the protective flap of the lock and turn the key to position  to unlock the coupling ball bar.

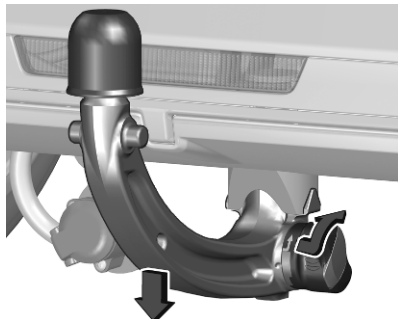

Pull out the rotary handle and turn clockwise as far as it will go. Pull out the coupling ball bar downwards.

Insert the sealing plug in opening. Fold away the socket.

Trailer stability assist

If the system detects snaking movements, engine power is reduced and the vehicle / trailer combination is selectively braked until the snaking ceases. While system is working keep steering wheel as still as possible.

The system operates from 37 mph to 99 mph.

Warning

In some situations, the system may not detect trailer snaking, e.g. when towing a light trailer. On slippery or poor surfaces, the system may not be able to prevent sudden trailer snaking.

Trailer stability assist is a function of the Electronic Stability Control  146.

Vehicle care

General Information	203
Accessories and vehicle modifications	203
Vehicle storage	204
End-of-life vehicle recovery	206
Vehicle checks	207
Performing work	207
Bonnet	207
Engine oil	208
Engine coolant	209
Washer fluid	210
Brakes	210
Brake fluid	210
Vehicle battery	211
High voltage battery	213
Diesel fuel system bleeding	213
Wiper blade replacement	214
Bulb replacement	214
Electrical system	215
Fuses	215
Vehicle tools	215
Tools	215
Wheels and tyres	216
Winter tyres	216

Tyre designations	216
Tyre pressure	217
Tyre deflation detection system	218
Tread depth	219
Changing tyre and wheel size ..	219
Wheel covers	219
Tyre chains	220
Tyre repair kit	220
Wheel changing	223
Spare wheel	225
Jump starting	228
Towing	230
Towing the vehicle	230
Towing another vehicle	231
Appearance care	232
Exterior care	232
Interior care	233
Floor mats	234

General Information

Accessories and vehicle modifications

We recommend the use of genuine parts and accessories and factory approved parts specific for your vehicle type. We cannot assess or guarantee reliability of other products - even if they have a regulatory or otherwise granted approval.

Any modification, conversion or other changes made to standard vehicle specifications (including, without limitation, software modifications, modifications of the electronic control units) may invalidate the warranty offered by Vauxhall. Furthermore, such changes may affect driver assistance systems, may impact fuel consumption, CO₂ emissions and other emissions of the vehicle and cause the vehicle to no longer conform to the operating permit, impacting the validity of your vehicle registration.

Caution

Access to the diagnostic socket associated with the on-board electronics is reserved for qualified technicians and approved tools.

Caution

When transporting the vehicle on a train or on a recovery vehicle, the mud flaps might be damaged.

Cold protection covers

It is recommended to have the cold protection covers installed by a workshop.

Caution

The cold protection covers must be removed when one of the following conditions occurs:

- The ambient temperature is above 10 °C.
- The vehicle is towing a trailer.
- The vehicle is driven at speeds above 75 mph.

Installation

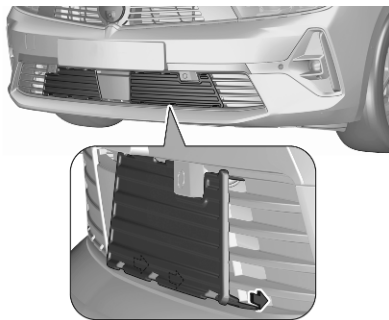

Press the protection covers against the slat of the grille. Ensure that the protection covers are fixed securely.

Deinstallation

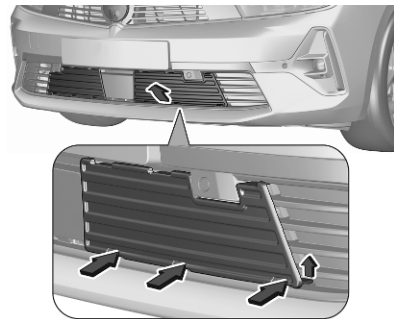

1. Move all lower flaps upwards to unclip the protection covers.
2. Pull the protection covers forwards and remove it.

Vehicle storage

Storage for a long period of time

If the vehicle is to be stored for several months:

- Wash the vehicle.
- Have the wax in the engine compartment and underbody checked.

- Clean and preserve the rubber seals.
 - Fill up fuel tank completely.
 - Change the engine oil.
 - Drain the washer fluid reservoir.
 - Check the coolant antifreeze and corrosion protection.
 - Adjust tyre pressure to the value specified for full load.
1. Park the vehicle in a dry, well ventilated place. Engage first or reverse gear or set selector lever to **P**. Prevent the vehicle from rolling.
 2. Do not apply the parking brake.
 3. Switch off ignition and all electrical consumers.
 4. Wait four minutes.
 5. Hybrid vehicle: Open the armrest.

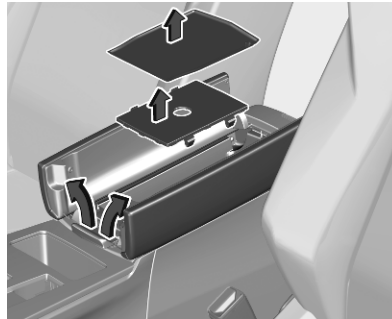

6. Hybrid vehicle: Detach the floor.

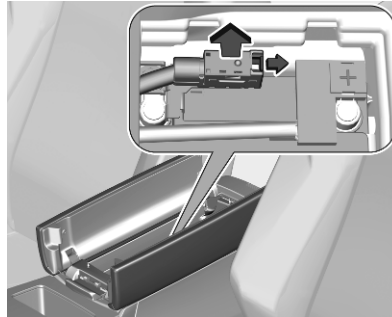

7. Hybrid vehicle: Release and remove connector from negative terminal.

8. Open the bonnet, close all doors and lock the vehicle.

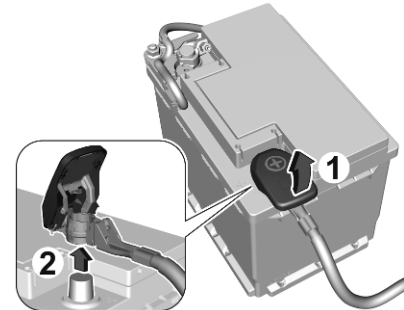

9. Lift the plastic cover of the vehicle battery's positive terminal in the engine compartment.
 10. Raise the lever fully and remove clamp from the terminal.
- Anti-theft alarm system ⇨ 21.

Storage hybrid vehicle up to four weeks

Plug in the charging cable.

Storage hybrid vehicle up to twelve months

- Discharge the high voltage battery until 30 percent remain on the battery range indicator (battery symbol) on the Driver Information Centre.
- Do not plug in the charging cable.
- Always store the vehicle in a place with temperatures between -10 °C and 30 °C.
- Vehicle storage at extreme temperatures may cause damage to the high voltage battery.
- Every three months, check the high voltage battery's state of charge. If the state of charge is below 30 percent, recharge the high voltage battery to 30 percent.

Putting back into operation

When the vehicle is to be put back into operation:

1. Connect the clamp to the positive terminal of the vehicle battery in the engine compartment.
2. Hybrid vehicle: Connect the clamp to the negative terminal of the vehicle battery under the armrest.
3. Initialise the power windows ⇨ 26.
 - Check tyre pressure.
 - Fill up the washer fluid reservoir.
 - Check the engine oil level.
 - Check the coolant level.
 - Fit the number plate if necessary.

End-of-life vehicle recovery

Information on end-of-life vehicle recovery centres and the recycling of end-of-life vehicles is available on our website, where legally required. Only entrust this work to an authorised recycling centre.

High voltage battery

The high voltage battery is designed for the life of the vehicle if the recommendations are followed. If it becomes necessary to replace the high voltage battery, contact a workshop for instructions on its disposal. Improper disposal carries the risk of severe burns, electric shock, and damage to the environment.

Recommendations ⇨ 213.

Vehicle checks

Performing work

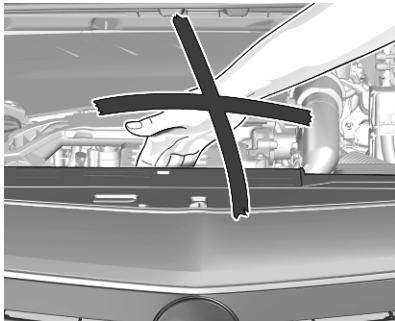

⚠ Warning

Only perform engine compartment checks when the ignition is off.
The cooling fan may start operating even if the ignition is off.

⚠ Danger

The ignition system uses extremely high voltage. Do not touch.

Hybrid vehicle



⚠ Danger

Never try to perform maintenance work on high voltage components yourself. You may be injured and the vehicle may be damaged. Service and repair of these high voltage components should only be performed by a trained service technician with proper knowledge and tools. Exposure to high voltage may cause shock, burns, and even death. The high voltage

components in the vehicle can only be serviced by technicians with special training.

High voltage components are identified by labels. Do not remove, open, take apart, or modify these components. High voltage cable or wiring has orange covering. Do not probe, tamper with, cut, or modify high voltage cable or wiring.

Caution

Even small amounts of contamination to the liquids can cause damage to vehicle systems. Do not allow contaminants to contact the fluids, reservoir caps, or dipsticks.

Bonnet

Opening

Open the left front door.

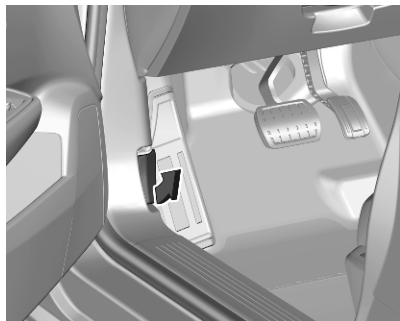

Pull the release lever and return it to its original position.

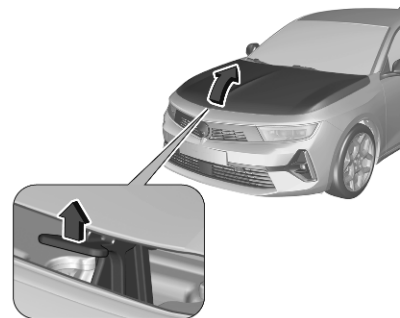

Push the safety catch upwards and open the bonnet.



Secure the bonnet support.

Closing

Before closing the bonnet, press the support into the holder.
Lower the bonnet and let it fall into the latch from a low height (20-25 cm).
Check that the bonnet is engaged.

Caution

Do not press the bonnet into the latch to avoid dents.

Engine oil

Check the engine oil level manually on a regular basis to prevent damage to the engine. Ensure that the correct specification of engine oil is used.

Recommended fluids and lubricants
↻ 238.

The maximum engine oil consumption is 0.6 l per 600 miles.

Check with the vehicle on a level surface. The engine must be at operating temperature and switched off for at least five minutes.

Caution

It is the owner's responsibility to maintain the proper level of an appropriate quality oil in the engine.

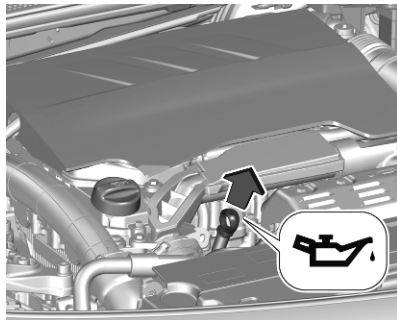

Different dipsticks are used depending on engine variant.

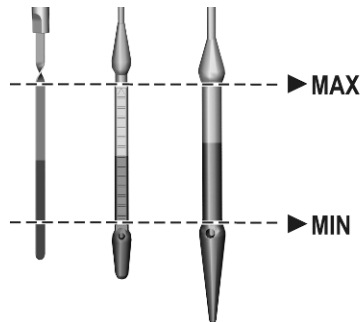

Pull out the dipstick, wipe it clean, reinsert it fully, pull out and read the engine oil level.

When the engine oil level has dropped to the **MIN** mark, top up the engine oil.

We recommend the use of the same grade of engine oil that was used at last change.

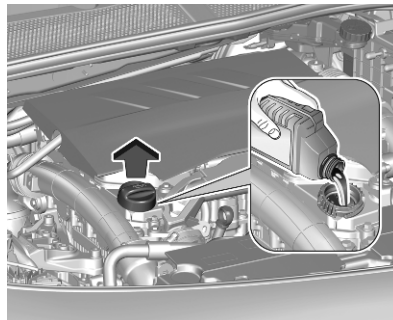

The engine oil level must not exceed the **MAX** mark on the dipstick.

Caution

Overfilled engine oil must be drained or suctioned out. If the oil exceeds the maximum level, do not start the vehicle and contact a workshop.

Fit the cap on straight and tighten it. Capacities ⇨ 247.

Engine coolant

The factory filled coolant provides freeze protection down to approx. -37 °C.

Caution

Only use approved antifreeze.

Coolant and antifreeze ⇨ 238.

Coolant level

Caution

Too low a coolant level can cause engine damage.

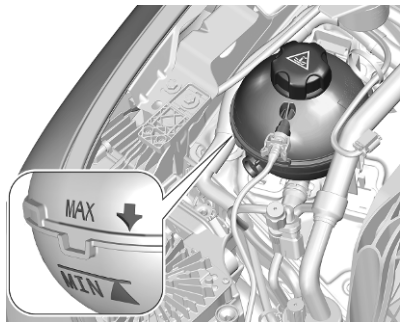

If the cooling system is cold, the coolant level should be above the **MIN** mark. Top up if the level is low.

⚠ Warning

Allow the engine to cool before opening the cap. Carefully open the cap, relieving the pressure slowly.

To top up, use a 1:1 mixture of released coolant concentrate mixed with clean tap water. If no coolant concentrate is available, use clean tap water. Install the cap tightly. Have

the coolant concentration checked and have the cause of the coolant loss remedied by a workshop.

Washer fluid

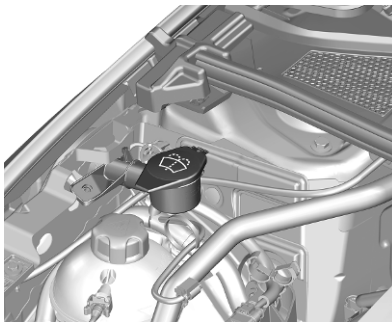

Fill with clean water mixed with a suitable quantity of approved windscreen washer fluid which contains antifreeze.

Caution

Only washer fluid with a sufficient antifreeze concentration provides protection at low temperatures or a sudden drop in temperature.

Washer fluid ⇨ 238.

Brakes

Depending on the driving style, the brake wear may vary significantly. The brake wear may increase when the vehicle is driven over short distances, e.g. in the city.

It may be necessary to have the condition of the brakes checked, even between vehicle services.

Unless there is a leak in the circuit, a drop in the brake fluid level indicates that the brake pads are worn.

Once new brake linings are installed, do not brake unnecessarily hard for the first few journeys.

Brake fluid

⚠ Warning

Brake fluid is poisonous and corrosive. Avoid contact with eyes, skin, fabrics and painted surfaces.

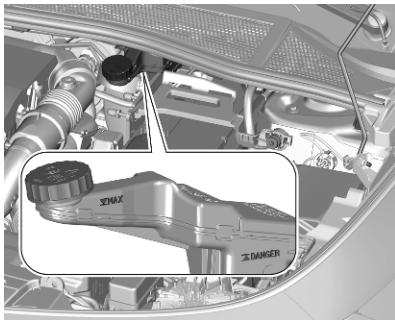

The brake fluid level must be between the **DANGER** and **MAX** marks.

If fluid level is below **DANGER** seek the assistance of a workshop.

Brake and clutch fluid ↻ 238.

Vehicle battery

The vehicle battery is maintenance-free provided that the driving profile allows sufficient charging of the battery. Short-distance-driving and frequent engine starts can discharge the battery. Avoid the use of unnecessary electrical consumers.



Batteries do not belong in household waste. They must be disposed of at an appropriate recycling collection point.

Laying up the vehicle for more than four weeks can lead to battery discharge. Disconnect the clamp from the positive terminal of the vehicle battery.

Ensure the ignition is switched off before connecting or disconnecting the vehicle battery.

Vehicle storage ↻ 204.

Battery discharge protection ↻ 102.

Replacing the vehicle battery

Notice

Any deviation from the instructions given in this section may lead to temporary deactivation or disturbance of the stop-start system.

When the vehicle battery is being replaced, please ensure that there are no open ventilation holes in the vicinity of the positive terminal. If a ventilation hole is open in this area, it must be closed off with a dummy cap, and the ventilation in the vicinity of the negative terminal must be opened.

Ensure that the battery is always replaced by the same type of battery.

The vehicle battery has to be replaced by a workshop.

Stop-start system ↻ 127.

Charging the vehicle battery

⚠ Warning

On vehicles with stop-start system, ensure that the charging potential does not exceed 14.6 V when using a battery charger. Otherwise the vehicle battery may be damaged.

Jump starting ↻ 228.

Discharge protection

Battery voltage

When the vehicle is being driven, the load reduction function temporarily deactivates certain functions, such as the air conditioning, the heated rear window, heated seats, heated steering wheel, etc.

The deactivated functions are reactivated automatically as soon as conditions permit.

Idle boost

If charging of the vehicle battery is required due to battery condition, the power output of the generator must be increased. This will be achieved by an idle boost which may be audible.

Power outlet

The power outlets are deactivated in the event of low vehicle battery voltage.

Warning label



Meaning of symbols:

- No sparks, naked flames or smoking.
- Always shield eyes. Explosive gases can cause blindness or injury.
- The vehicle battery contains sulphuric acid which could cause blindness or serious burn injuries.
- Keep the vehicle battery out of reach of children.

- See the Owner's Manual for further information.
- Explosive gas may be present in the vicinity of the vehicle battery.

Power saving mode

This mode deactivates electrical consumers to avoid excessive discharging of the vehicle battery. These consumers, such as the Infotainment system, windscreen wipers, low beam headlights, courtesy light, etc. can be used for a total maximum time of about 40 minutes after ignition is switched off.

Changing into power saving mode

When power saving mode is activated, a message appears in the Driver Information Centre.

An active telephone call using the hands-free option will be maintained for around ten minutes longer.

Deactivating power saving mode

Power saving mode is deactivated automatically when the engine is restarted. Run the engine for a sufficient charge:

- for less than ten minutes to use the consumers for approx. five minutes
- for more than ten minutes to use the consumers for up to approx. 30 minutes

High voltage battery

To preserve the range and the durability of the high voltage battery, the following is recommended:

- Whenever possible do not charge the high voltage battery more than 80%.
- Do not completely discharge the high voltage battery.
- Do not store the vehicle for a long period of non-use (more than twelve hours) when the high voltage battery has a low or high charge level. Prefer a charge level between 20 and 40%.

- Limit the use of fast charging.
- Do not expose the vehicle to temperatures below -30 °C and above 60 °C for more than 24 hours.
- Avoid charging the vehicle at low temperatures (except if the vehicle ran more than 20 minutes) or above 30 °C.
- Do not use the high voltage battery as a generator of energy.
- Do not use a generator to recharge the high voltage battery.

Vehicle storage ⇨ 204.

Leakage

Damage to the high voltage battery could result in the leakage of toxic gases or fluids either immediately or later. The following is recommended:

- Always inform the fire and emergency services in the event of an incident, that the vehicle is equipped with a high voltage battery.
- Never touch the liquids leaking from the high voltage battery.

- Do not inhale the gases emitted by the high voltage battery which are toxic.
- Move away from the vehicle in the event of incident or accident, the gases emitted being flammable and could cause a fire.
- Too low a coolant level must be topped up and the cause of the coolant loss remedied by a workshop.

Diesel fuel system bleeding

If the tank has been run dry, the diesel fuel system must be bled. Refuel at least five litres diesel. Switch on the ignition for about 60 seconds and switch off again. Then crank the engine. If the engine does not start directly, repeat this process a few times. If the engine then fails to start, seek the assistance of a workshop.

Wiper blade replacement

Windscreen

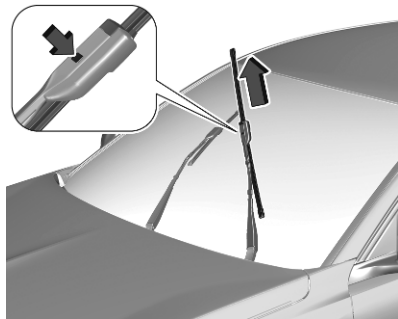

Switch off ignition.

Within one minute after switching off ignition, operate the wiper lever to position the wiper blades vertically on the windscreen.

Lift the wiper arm until it stays in the raised position, press button to disengage the wiper blade and remove.

Attach the new wiper blade to the wiper arm and push until it engages.

Lower wiper arm carefully.

To return the wiper arms to their original position, switch on the ignition and operate the wiper lever.

Rear window

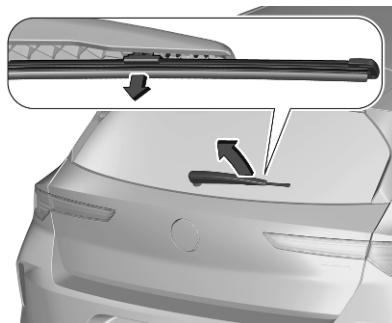

Lift wiper arm. Disengage wiper blade as shown in illustration and remove.

Attach the wiper blade to the inner position of the wiper arm and push until it engages.

Lower wiper arm carefully.

Bulb replacement

Exterior lights are designed as LEDs and cannot be changed.

Have exterior and interior lights repaired by a workshop in case of failure.

Electrical system

Fuses

A defective fuse must be replaced by a workshop.

Vehicle tools

Tools

Vehicles with spare wheel

Open the floor cover of the load compartment ⇨ 60.

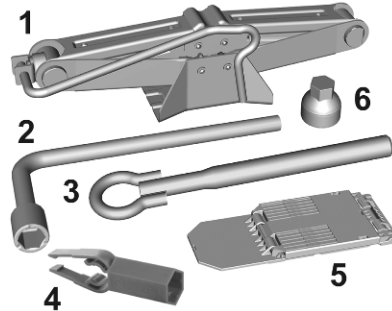

These tools are located in the toolbox:

- Jack (1)
- Wheel wrench (2)
- Towing eye (3)
- Wheel bolt cover remover (4)

- Chock (5)
- Adapter for the locking wheel nuts (6)

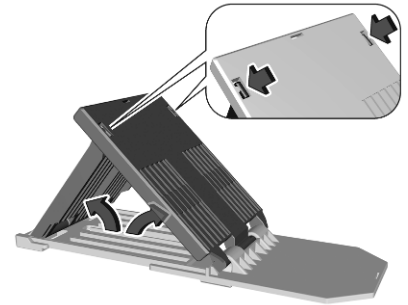

To use the chock, fold apart and stick together.

Vehicles without spare wheel

Open the floor cover of the load compartment ⇨ 60.



The towing eye is located in a bag.
Tyre repair kit ↗ 220.

Wheels and tyres

Tyre condition, wheel condition

Drive over edges slowly and at right angles if possible. Driving over sharp edges can cause tyre and wheel damage. Do not trap tyres on the kerb when parking.

Regularly check the wheels for damage. Seek the assistance of a workshop in the event of damage or unusual wear.

Winter tyres

Winter tyres improve driving safety at temperatures below 7 °C and should therefore be fitted on all wheels.

In accordance with country-specific regulations, affix the speed sticker in the driver's field of view, if the tyre speed code is below the maximum speed of the vehicle.

All tyre sizes are permitted as winter tyres ↗ 248.

Tyre designations

E.g. **225/55 R 18 98 V**

- 225** : tyre width, mm
- 55** : cross-section ratio (tyre height to tyre width), %
- R** : belt type: Radial
- RF** : type: RunFlat
- 18** : wheel diameter, inches
- 98** : load index e.g. 98 is equivalent to 750 kg
- V** : speed code letter

Speed code letter:

- Q** : up to 100 mph
- S** : up to 112 mph
- T** : up to 118 mph
- H** : up to 130 mph
- V** : up to 150 mph
- W** : up to 168 mph

Choose a tyre appropriate for the maximum speed of the vehicle.

The maximum speed is achievable at kerb weight with driver (75 kg) plus 125 kg payload. Optional equipment could reduce the maximum speed of the vehicle.

Directional tyres

Directional tyres should be mounted so that they rotate in the correct direction. The proper rotation direction is indicated by a symbol (e.g. an arrow) on the sidewall.

Tyre pressure

Check the pressure of cold tyres at least every 14 days and before any long journey. Do not forget the spare wheel. This also applies to vehicles with tyre deflation detection system.

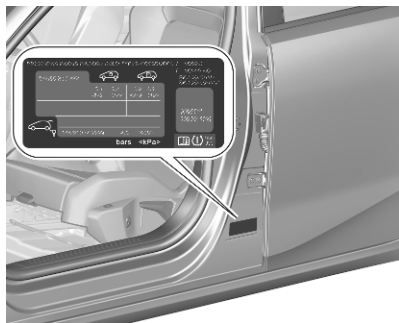

Tyre pressure ⇨ 248.

The tyre pressure information label indicates the original equipment tyres and the correspondent tyre pressures.

The tyre pressure data refers to cold tyres. It applies to summer and winter tyres.

Always inflate the spare tyre to the pressure specified for full load.

Incorrect tyre pressures will impair safety, vehicle handling, comfort and fuel economy and will increase tyre wear.

Tyre pressures differ depending on various options. For the correct tyre pressure value, follow the procedure below:

1. Identify the respective tyre.
2. Identify the engine identifier code.

Engine data ⇨ 243.

The tyre pressure tables show all possible tyre combinations ⇨ 248.

For the tyres approved for your vehicle, refer to the EEC Certificate of Conformity provided with your vehicle or other national registration documents.

The driver is responsible for correct adjustment of tyre pressure.

⚠ Warning

If the pressure is too low, this can result in considerable tyre warm-up and internal damage, leading to tread separation and even to tyre blow-out at high speeds.

⚠ Warning

For specific tyres the recommended tyre pressure as shown in the tyre pressure table may exceed the maximum tyre pressure as indicated on the tyre. Never exceed the maximum tyre pressure as indicated on the tyre.

Temperature dependency

The tyre pressure depends on the temperature of the tyre. During driving, tyre temperature and pressure increase. Tyre pressure values provided on the tyre

information label and tyre pressure chart are valid for cold tyres, which means at 20 °C.

The pressure increases by nearly 1.5 psi for a 10 °C temperature increase. This must be considered when warm tyres are checked.

Tyre deflation detection system

The tyre deflation detection system continually checks the rotation speed of all four wheels and warns on low tyre pressure condition once vehicle is driving. This is achieved by comparing tyre rolling circumference with reference values and further signals.

If a tyre loses pressure the control indicator (U) illuminates and a warning message is displayed in the Driver Information Centre.

Control indicator (U) ⇨ 84.

In this case reduce speed, avoid sharp cornering and strong braking. Stop at next safe opportunity and check tyre pressure.

After adjusting tyre pressure initialise system to extinguish the control indicator and restart system.

If the failure continues to be displayed, contact a workshop. The system is inoperable when the ABS or Electronic Stability Control has a malfunction or a temporary spare wheel is used. Once the tyre has been refitted, check the tyre pressure with cold tyres and initialise the system.

Caution

Deflation detection system warns just about low tyre pressure condition and does not replace regular tyre maintenance by the driver.

System initialisation

After tyre pressure correction or wheel change, the system must be initialised to learn new circumference reference values:

1. Always ensure that all four tyres have correct tyre pressure ⇨ 248.
2. Apply parking brake.
3. Initialise the system via the Info Display ⇨ 86.
4. Reset is confirmed by pop-up indication.

After initialisation system automatically calibrates to new tyre pressures during driving. After longer drive the system will adopt and monitor new pressures.

Always check tyre pressure with cold tyres.

System has to be reinitialised when:

- Tyre pressure has been changed
- Load condition has been changed
- Wheels have been swapped or exchanged

The system will not warn instantaneously on a tyre blow out or a rapid deflation. This is due to required calculation time.

Tread depth

Check tread depth at regular intervals.

For safety reasons, it is recommended that the tread depth of the tyres on one axle should not vary by more than 2 mm.



The legally permissible minimum tread depth (1.6 mm) has been reached when the tread has worn down as far as one of the tread wear indicators (TWI). Their position is indicated by markings on the sidewall.

If there is more wear at the front than the rear, swap round front wheels and rear wheels periodically. Ensure that the direction of rotation of the wheels remains the same.

Tyres age, even if they are not used. We recommend tyre replacement every six years.

Changing tyre and wheel size

If tyres of a different size than those fitted at the factory are used, it may be necessary to reprogramme systems and make other vehicle modifications.

Have the label with tyre pressures replaced.

⚠ Warning

The use of unsuitable tyres or wheels may lead to accidents and will invalidate the vehicle operating permit.

Wheel covers

Wheel covers and tyres that are factory approved for the respective vehicle and comply with all of the relevant wheel and tyre combination requirements must be used.

If the wheel covers and tyres used are not factory approved, the tyres must not have a wheel rim protection ridge.

Wheel covers must not impair brake cooling.

⚠ Warning

Use of unsuitable tyres or wheel covers could lead to sudden pressure loss and thereby accidents.

Vehicles with steel wheel rims: When using locking wheel nuts, do not attach wheel covers.

Temporary spare wheel: Do not use wheel covers.

Tyre chains

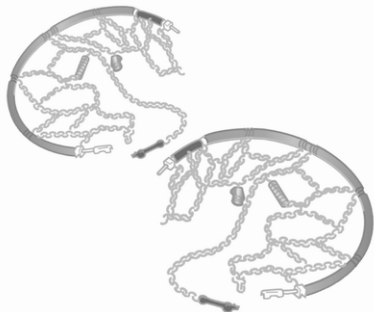

Tyre chains are only permitted on the front wheels.

Only use tyre chains designed to be used with tyre type of the vehicle:

- For 16 inch and 17 inch tyres, only use fine mesh tyre chains that add no more than 9 mm to the tyre tread and the inboard sides (including chain lock).
- For 18 inch tyres, only use Polaire PSGB 60 tyre chains.

Notice

The use of tyre chains and the maximum allowed speed is regulated by country-specific legislation.

⚠ Warning

Damage may lead to tyre blowout.

When fitting the tyre chains follow the instructions provided by the manufacturer of the tyre chains.

After having fitted the tyre chains, stop the vehicle after having driven a short distance and make sure that the tyre chains are correctly tightened.

Temporary spare wheel

The use of tyre chains is not permitted on the temporary spare wheel.

Tyre repair kit

Minor damage to the tyre tread can be repaired with the tyre repair kit.

Do not remove foreign bodies from the tyres.

Tyre damage exceeding 4 mm or that is at tyre's sidewall cannot be repaired with the tyre repair kit.

Depending on version, there are two different tyre repair kits (Type A and Type B).

⚠ Warning

Do not drive faster than 50 mph.
Do not use for a lengthy period.
Steering and handling may be affected.

In the case of a flat tyre:

Apply the parking brake and engage first gear, reverse gear or **P**.

The tyre repair kit is in the load compartment below the floor cover. Depending on version, the location of the tyre repair kit below the floor cover is different.

1. Remove the sealant bottle and the compressor.
2. Pull speed limit label from sealant bottle and place it in driver's visible area.

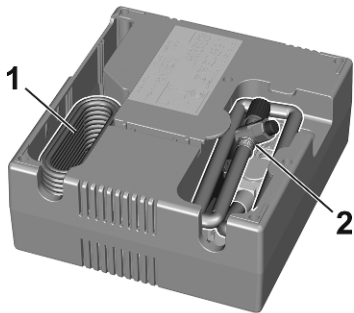

3. Remove the electrical connection cable (1) and air hose (2) from the stowage compartments on the underside of the compressor.

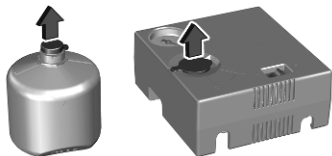

4. Type A: Open sealant bottle and lift the lid.

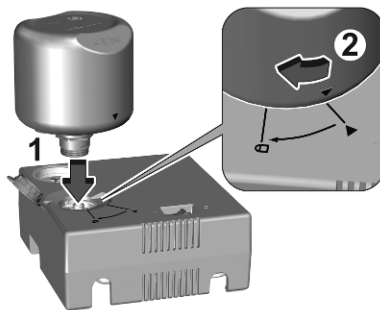

5. Type A: First, insert sealant bottle into the compressor and align the triangle symbols. Then, push down sealant bottle and turn it to the lock position.

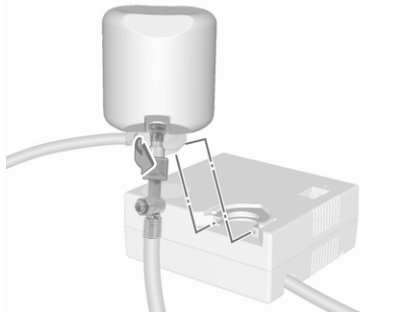

- Type B: Screw the compressor air hose to the connection on the sealant bottle.
6. Type B: Fit the sealant bottle into the bracket on the compressor.
7. Set the compressor near the tyre in such a way that the sealant bottle is upright.
8. Unscrew valve cap from defective tyre.

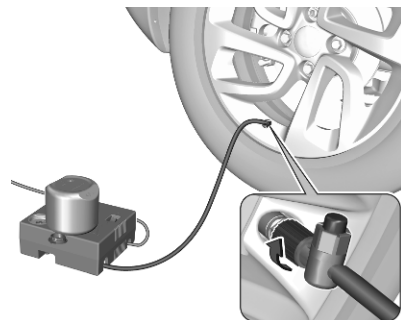

9. Screw the filler hose to the tyre valve.
10. The switch on the compressor must be set to O.

11. Connect the compressor plug to the power outlet or cigarette lighter socket.

The tyre repair kit may only be plugged in to the front 12 V power outlet, in order to work properly.

To avoid discharging the battery, we recommend running the engine.

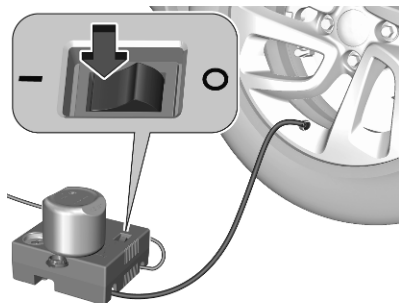

12. Set the rocker switch on the compressor to I. The tyre is filled with sealant.
13. The compressor pressure gauge briefly indicates up to 600 kPa (6 bar) whilst the sealant

bottle is emptying (approx. 30 seconds). Then the pressure starts to drop.

14. All of the sealant is pumped into the tyre. Then the tyre is being inflated.
15. The prescribed tyre pressure should be obtained within ten minutes.

Tyre pressure ⇨ 248.

When the correct pressure is obtained, switch off the compressor.

If the prescribed tyre pressure is not obtained within ten minutes, remove the tyre repair kit. Move the vehicle one tyre rotation. Reattach the tyre repair kit and continue the filling procedure for ten minutes. If the prescribed tyre pressure is still not obtained, the tyre is too badly damaged. Seek the assistance of a workshop.

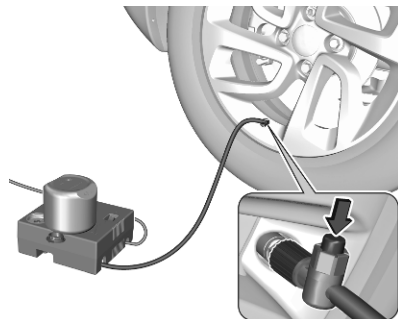

Drain excess tyre pressure with the button on the air hose.

Do not run the compressor longer than ten minutes.

16. Detach the tyre repair kit. Remove sealant bottle from bracket. Screw the filler hose to the free connection of the sealant bottle. This prevents sealant from escaping. Stow tyre repair kit in load compartment.
17. Remove any excess sealant using a cloth.

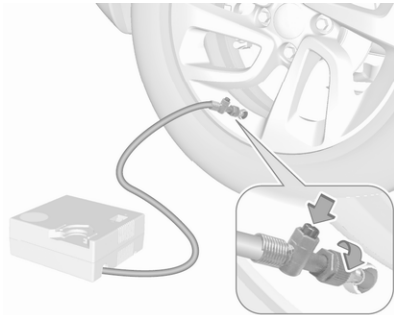

18. Continue driving immediately so that sealant is evenly distributed in the tyre. After driving approx. 3 miles but no more than ten minutes, stop and check tyre pressure. Screw compressor air hose directly onto tyre valve when doing this. Fill tyre as described before. Drain excess tyre pressure with the button on the air hose.

If tyre pressure hasn't decreased under 200 kPa (2.0 bar), set it to the correct value ↻ 248. Otherwise the vehicle must not be used. Seek assistance of a workshop.

Repeat the checking procedure once more after driving further 6 miles but no more than ten minutes to check that there is no more loss of pressure.

If the tyre pressure has fallen below 200 kPa (2.0 bar), the vehicle must not be used. Seek the assistance of a workshop.

19. Stow away tyre repair kit in load compartment.

Notice

The driving characteristics of the repaired tyre are severely affected, therefore have this tyre replaced.

If unusual noise is heard or the compressor becomes hot, turn compressor off for at least 30 min.

The built-in safety valve opens at a pressure of seven bar (102 psi).

Note the expiry date of the kit. After this date its sealing capability is no longer guaranteed. Pay attention to storage information on sealant bottle.

Replace the used sealant bottle. Dispose of the bottle as prescribed by applicable laws.

The compressor and sealant can be used from approx. -30 °C.

Wheel changing

Make the following preparations and observe the following information:

- Park the vehicle on a level, firm and non-skid surface. The front wheels must be in the straight-ahead position.
- Apply the parking brake and engage first gear, reverse gear or **P**.
- Place a chock under the wheel diagonally opposite the wheel to be changed.
- If the ground on which the vehicle is standing is soft, a solid board (approx. 1 cm thick) should be placed under the jack.
- Take heavy objects out of the vehicle before jacking up.
- No people or animals may be in the vehicle when it is jacked-up.

- Never crawl under a jacked-up vehicle.
- Do not start the vehicle when it is raised on the jack.
- Before screwing in the wheel bolts, clean them.

⚠ Warning

Do not grease wheel bolts.

Tightening torques

⚠ Warning

Ensure to use always the correct wheel bolts if changing the wheels. When installing the spare wheel for temporary usage, the bolts for alloy wheel rims can also be used.

Depending on the wheel rim material, two different bolts are available.

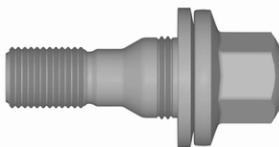

Tightening torque for alloy wheel rims is 115 Nm.

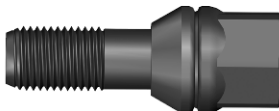

Tightening torque for steel wheel rims is 115 Nm.

Use the correct wheel bolts for the respective wheel rims.

Jacking positions

The jacking positions shown refer to the use of lifting arms and accessory jacks used for changing winter / summer tyres.

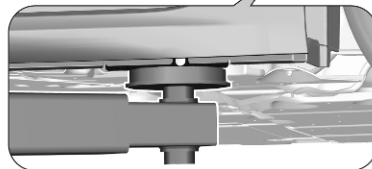

Rear arm position of the lifting platform centrally under the relevant vehicle jacking point.

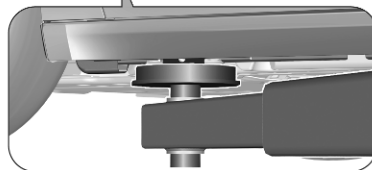

Front arm position of the lifting platform centrally under the relevant vehicle jacking point.

Spare wheel

The spare wheel can be classified as a temporary spare wheel depending on the size compared to the other mounted wheels and country regulations. In this case a permissible maximum speed applies, even though no label at the spare wheel indicates this.

Only mount one temporary spare wheel. Do not drive faster than 50 mph. Take curves slowly. Do not use for a long period of time.

Caution

The use of a spare wheel that is smaller than the other wheels or in combination with winter tyres could affect driveability. Have the defective tyre replaced as soon as possible.

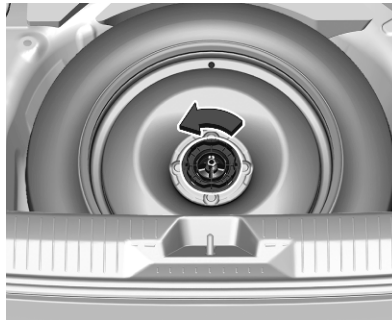

The spare wheel is located in the load compartment beneath the floor covering.

To remove:

1. Open the floor cover ⇨ 60.
2. The temporary spare wheel is secured with a wing nut. Unscrew nut and take out the spare wheel.
3. When, after a wheel change, no wheel is placed in the spare wheel well, tighten the wing nut and close floor cover.
4. After wheel change back to full size wheel, place the temporary spare wheel in the well and secure with the wing nut.

The permissible maximum speed on the label on the temporary spare wheel is only valid for the factory-fitted tyre size.

Fitting the spare wheel

Make the following preparations and observe the following information:

- Park the vehicle on a level, firm and non-skid surface. The front wheels must be in the straight-ahead position.
- Apply the parking brake and engage first gear, reverse gear or **P**.
- Place a chock under the wheel diagonally opposite the wheel to be changed.
- Remove the spare wheel.
- Never change more than one wheel at once.
- Use the jack only to change wheels in case of puncture, not for seasonal winter or summer tyre change.
- The jack is maintenance-free.

- If the ground on which the vehicle is standing is soft, a solid board (approx. 1 cm thick) should be placed under the jack.
- Take heavy objects out of the vehicle before jacking up.
- No people or animals may be in the vehicle when it is jacked-up.
- Never crawl under a jacked-up vehicle.
- Do not start the vehicle when it is raised on the jack.
- Before screwing in the wheel bolts, clean them.

⚠ Warning

Do not grease wheel bolts.

⚠ Warning

Ensure to use always the correct wheel bolts if changing the wheels. When installing the spare wheel for temporary usage, the bolts for alloy wheel rims can also be used.

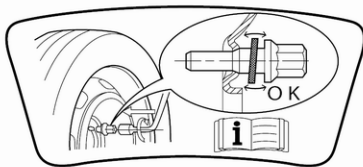

- Note that the spare wheel is secured by the conical contact of each bolt if the wheel bolts for the alloy wheel rims are used. In this case, the washers do not come into contact with the spare wheel.

1. Disengage wheel bolt caps with the wheel bolt cover remover.

Vehicle tools ⇨ 215.

Steel wheel rims with cover: Pull off the wheel cover.



2. Attach the wheel wrench and loosen each wheel bolt by half a turn.

The wheels might be protected by locking wheel nuts. To loosen these specific nuts first attach the adapter onto the head of the nut before installing the wheel wrench. The adapter is located in the tool bag ⇨ 215.

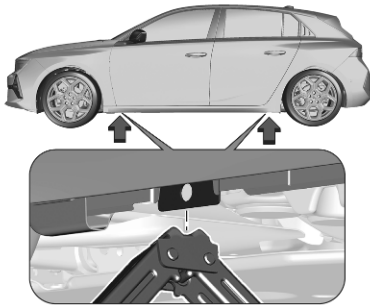

3. Ensure the jack is correctly positioned under the relevant vehicle jacking point.

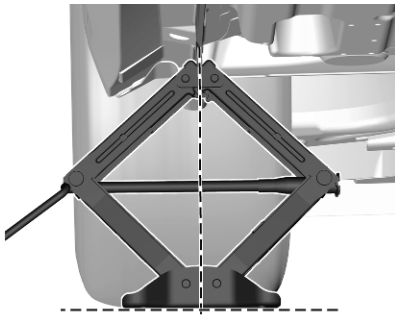

4. Set the jack to the necessary height. Position it directly below

the jacking point in a manner that prevents it from slipping.

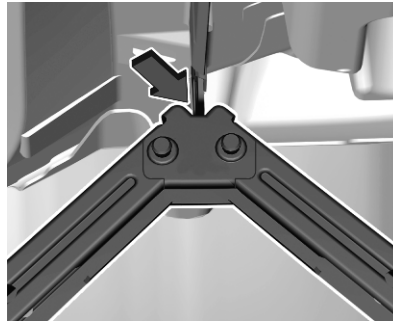

Ensure that the edge of the body fits into the notch of the jack.



With the jack correctly aligned rotate wheel wrench until wheel is clear of the ground.

5. Unscrew the wheel nuts.
6. Change the wheel.
7. Screw on the wheel nuts.
8. Lower the vehicle and remove jack.
9. Install the wheel wrench ensuring that it is located securely and tighten each bolt in a crosswise sequence.
Tightening torque is 115 Nm.
10. Stow the replaced wheel, the vehicle tools and the adapter for the locking wheel nuts ↗ 215.
11. Check the tyre pressure of the installed tyre and the wheel bolt torque as soon as possible.

Stowing a damaged full size wheel in the load compartment

The spare wheel well is not designed for other tyre sizes than the spare wheel. A damaged full size wheel must be stowed in the load compartment and secured properly.

Loading information ⇨ 63.

Jump starting

Do not start with quick charger.

A vehicle with a discharged vehicle battery can be started using jump leads and the vehicle battery of another vehicle.

Caution

Never jump start another vehicle with a hybrid vehicle.

⚠ Warning

Be extremely careful when starting with jump leads. Any deviation from the following instructions can lead to injuries or damage caused by battery explosion or damage to the electrical systems of both vehicles.

⚠ Warning

Avoid contact of the battery with eyes, skin, fabrics and painted surfaces. The fluid contains sulphuric acid which can cause injuries and damage in the event of direct contact.

Caution

Connect the jump lead terminals in a way that they do not come in contact with control units. Select a suitable terminal position.

- Never expose the vehicle battery to naked flames or sparks.
- A discharged vehicle battery can already freeze at a temperature of 0 °C. Defrost the frozen battery before connecting jump leads.
- Wear eye protection and protective clothing when handling a battery.

- Use a booster battery with the same voltage (12 V). Its capacity (Ah) must not be much less than that of the discharged vehicle battery.
- Use jump leads with insulated terminals and a cross section of at least 16 mm² (25 mm² for diesel engines).
- Do not disconnect the discharged vehicle battery from the vehicle.
- Switch off all unnecessary electrical consumers.
- Do not lean over the vehicle battery during jump starting.
- Do not allow the terminals of one lead to touch those of the other lead.
- The vehicles must not come into contact with each other during the jump starting process.
- Apply the parking brake, transmission in neutral, automatic transmission in **P**.

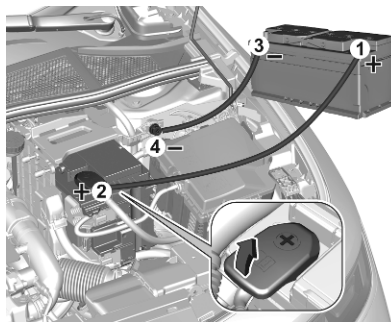

Lead connection order:

1. Connect the red lead to the positive terminal of the booster battery.
2. Connect the other end of the red lead to the positive terminal of the discharged battery.
3. Connect the black lead to the negative terminal of the booster battery.
4. Connect the other end of the black lead to a vehicle grounding point of your vehicle in the engine compartment.

Route the leads so that they cannot catch on rotating parts in the engine compartment.

To start the engine:

1. Start the engine of the vehicle providing the jump.
2. After five minutes, start the other engine. Start attempts should be made for no longer than 15 seconds at an interval of one minute.
3. Allow both engines to idle for approx. three minutes with the leads connected.
4. Switch on electrical consumers e.g. headlights, heated rear window.
5. Reverse above sequence exactly when removing leads.

Towing

Towing the vehicle



Remove the cap.

The towing eye is stowed with the vehicle tools ⇨ 215.



Screw in the towing eye as far as it will go until it stops in a horizontal position.

Attach the tow rod to the towing eye.

The towing eye must only be used for towing and not for recovering the vehicle.

Switch on ignition to release steering wheel lock and to permit operation of brake lights, horn and windscreen wiper.

Caution

Deactivate the driver assistance systems like active emergency braking ⇨ 159, otherwise the vehicle may automatically brake during towing.

Switch the selector lever to neutral.
Release the parking brake.

Caution

Drive slowly. Do not drive jerkily. Excessive tractive force can damage the vehicle.

When the engine is not running, considerably more force is needed to brake and steer.

To prevent the entry of exhaust gases from the towing vehicle, switch on the air recirculation and close the windows.

When towing a vehicle equipped with an automatic transmission, transport the vehicle on a platform or tow it with the front wheels lifted.

After towing, unscrew the towing eye.
 Insert cap with the flange into the recess and fix cap by pushing.

Towing another vehicle



Remove the cap.
 The towing eye is stowed with the vehicle tools ⇨ 215.

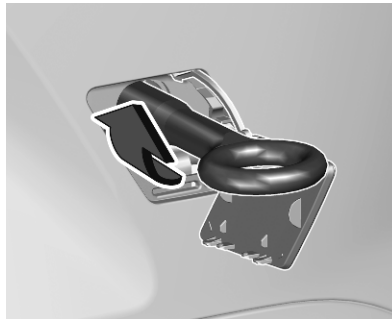

Insert cap with the upper flange into the recess and fix cap by pushing.

Screw in the towing eye as far as it will go until it stops in a horizontal position.

Attach a tow rope – or better still a tow rod – to the towing eye.

The towing eye must only be used for towing and not for recovering a vehicle.

Caution
<p>Drive slowly. Do not drive jerkily. Excessive tractive force can damage the vehicle.</p>

After towing, unscrew the towing eye.

Appearance care

Exterior care

Locks

The locks are lubricated at the factory using a high quality lock cylinder grease. Use a de-icing agent only when absolutely necessary, as this has a degreasing effect and impairs lock function. After using a de-icing agent, have the locks regreased by a workshop.

Washing

The paintwork of your vehicle is exposed to environmental influences.

Bird droppings, dead insects, resin, pollen and the like should be cleaned off immediately, as they contain aggressive constituents which can cause paint damage.

If using a vehicle wash, comply with the vehicle wash manufacturer's instructions. The windscreen wiper and rear window wiper must be

switched off. Remove antenna and external accessories such as roof racks etc.

If you wash your vehicle by hand, make sure that the insides of the wheel housings are also thoroughly rinsed out.

Clean edges and folds on opened doors and the bonnet as well as the areas they cover.

Clean bright metal mouldings with a cleaning solution approved for aluminium to avoid damages.

Caution
<p>Always use a cleaning agent with a pH value of 4 to 9.</p> <p>Do not use cleaning agents on hot surfaces.</p>

Do not clean the engine compartment with a steam-jet or high-pressure jet cleaner.

Thoroughly rinse and leather-off the vehicle. Rinse leather frequently. Use separate leathers for painted and glass surfaces: remnants of wax on the windows will impair vision.

Have the door hinges of all doors greased by a workshop.

Exterior lights

Headlight and other light covers are made of plastic. Do not use any abrasive or caustic agents, do not use an ice scraper, and do not clean them dry.

Polishing and waxing

Polishing is necessary only if the paint has become dull or if solid deposits have become attached to it.

Plastic body parts must not be treated with wax or polishing agents.

Windows and wiper blades

Switch off wipers before handling in their areas.

Use a soft lint-free cloth or chamois leather together with window cleaner and insect remover.

When cleaning the rear window from inside, always wipe in parallel to the heating element to prevent damage.

For mechanical removal of ice, use a sharp-edged ice scraper. Press the scraper firmly against the glass so that no dirt can get under it and scratch the glass.

Clean smearing wiper blades with a soft cloth and window cleaner. Also make sure to remove any residues such as wax, insect residues and similar from the window.

Ice residues, pollution and continuous wiping on dry windows will damage or even destroy the wiper blades.

Wheels and tyres

Do not use high-pressure jet cleaners.

Clean rims with a pH-neutral wheel cleaner.

Rims are painted and can be treated with the same agents as the body.

Paintwork damage

Rectify minor paintwork damage with a touch-up pen before rust forms. Have more extensive damage or rust areas repaired by a workshop.

Underbody

Some areas of the vehicle underbody have a PVC undercoating while other critical areas have a durable protective wax coating.

After the underbody is washed, check the underbody and have it waxed if necessary.

Bitumen / rubber materials could damage the PVC coating. Have underbody work carried out by a workshop.

Before and after winter, wash the underbody and have the protective wax coating checked.

Towing equipment

Do not clean the coupling ball bar with a steam-jet or high-pressure jet cleaner.

Interior care

Interior and upholstery

Only clean the vehicle interior, including the instrument panel fascia and panelling, with a dry cloth or interior cleaner.

Clean the leather upholstery with clear water and a soft cloth. In case of heavy soiling, use leather care.

The Driver Information Centre and the displays should only be cleaned using a soft damp cloth. If necessary use a weak soap solution.

Clean fabric upholstery with a vacuum cleaner and brush. Remove stains with an upholstery cleaner.

Clothing fabrics may not be colourfast. This could cause visible discolourations, especially on light-coloured upholstery. Removable stains and discolourations should be cleaned as soon as possible.

Clean seat belts with lukewarm water or interior cleaner.

Caution

Close Velcro fasteners as open Velcro fasteners on clothing could damage seat upholstery.

The same applies to clothing with sharp-edged objects, like zips or belts or studded jeans.

Plastic and rubber parts

Plastic and rubber parts can be cleaned with the same cleaner as used to clean the body. Use interior cleaner if necessary. Do not use any other agent. Avoid solvents and petrol in particular. Do not use high-pressure jet cleaners.

Floor mats**⚠ Warning**

If a floor mat has the wrong size or is not properly installed, it can interfere with pedals, what can

cause unintended acceleration or increased stopping distance which can cause a crash and injury.

Use the following guidelines for proper floor mat usage.

- The original equipment floor mats were designed for this vehicle. If the floor mats need to be replaced, it is recommended to buy certified floor mats which fit properly and are fixed by the retainers on the driver side. Always check that the floor mats do not interfere with the pedals.
- Use the floor mat with the correct side up. Do not turn it over.
- Do not place anything on top of the driver side floor mat.
- Use only a single floor mat on the driver side.

Inserting and removing the floor mats

The driver side floor mat is held in place by two retainers.

To install the floor mat:

1. Move the seat backwards as far as possible.

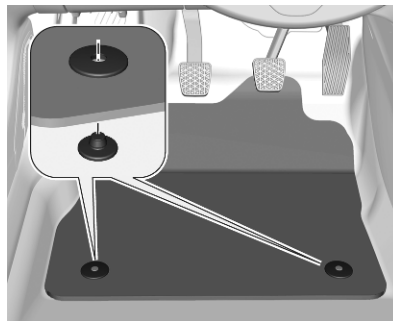

2. Align slots in the mat with the retainers, as shown.
3. Push the mat to the floor.

Removing

1. Move the seat backwards as far as possible.
2. Remove the mat.

Service and maintenance

General information	235
Service information	235
Recommended fluids, lubricants and parts	238
Recommended fluids and lubricants	238

General information

Service information

In order to ensure economical and safe vehicle operation and to maintain the value of your vehicle, it is of vital importance that all maintenance work is carried out at the proper intervals as specified.

The detailed, up-to-date service schedule for your vehicle is available at the workshop.

Severe operating conditions exist if one or more of the following circumstances occur frequently: Cold starting, stop and go operation, e.g. for taxis and police vehicles, trailer operation, mountain driving, driving on poor and sandy road surfaces, increased air pollution, presence of airborne sand and high dust content, driving at high altitude and large variations of temperature.

Under these severe operating conditions, certain service work may be required more frequently than the regular service interval indicated in

the service display. Contact a workshop for customised service schedules.

Service display ⇨ 76.

Service intervals

Engine code	EB2ATD, EB2ADTS, EB2ADTSM	DV5RC	EP6FADTXHPD (Hybrid version)
Country group 1	12,500 miles / 1 year	20,000 miles / 1 year ¹⁾	20,000 miles / 1 year

1) Unless otherwise indicated in the service display.

Country Group 1:

Andorra, Austria, Belgium, Cyprus, Denmark, Finland, France, Germany, Greece, Iceland, Italy, Liechtenstein, Luxembourg, Malta, Monaco, Netherlands, Norway, Portugal, Republic of Ireland, San Marino, Spain, Sweden, Switzerland, United Kingdom.

Country Group 2:

Bosnia-Herzegovina, Bulgaria, Croatia, Czech Republic, Estonia, Hungary, Latvia, Lithuania, North Macedonia, Poland, Romania, Slovakia, Slovenia.

Country Group 3:

Albania, Kosovo, Montenegro, New Zealand, Serbia.

Country Group 4:

Israel, Lesotho, South Africa, Swaziland, Turkey.

Country Group 5:

Russia.

Country Group 6:

All other countries which are not listed in the previous country groups.

Confirmations

Confirmation of service is recorded in the Service and warranty booklet. The date and mileage is completed with the stamp and signature of the servicing workshop.

Make sure that the Service and warranty booklet is completed correctly as continuous proof of service is essential if any warranty or goodwill claims are to be met, and is also a benefit when selling the vehicle.

Recommended fluids, lubricants and parts

Recommended fluids and lubricants

Only use products that meet the recommended specifications.

Warning

Operating materials are hazardous and could be poisonous. Handle with care. Pay attention to information given on the containers.

Engine oil

Engine oil is identified by its quality and its viscosity. Quality is more important than viscosity when selecting which engine oil to use. The oil quality ensures e.g. engine cleanliness, wear protection and oil aging control, whereas viscosity grade gives information on the oil's thickness over a temperature range.

Select the appropriate engine oil based on its quality and on the minimum ambient temperature.

Topping up engine oil

Caution

In case of any spilled oil, wipe it up and dispose it properly.

Engine oils of different manufacturers and brands can be mixed as long as they comply with the required engine oil quality and viscosity.

Use of engine oils for all petrol engines with only ACEA quality is prohibited, since it can cause engine damage under certain operating conditions.

Select the appropriate engine oil based on its quality and on the minimum ambient temperature.

Additional engine oil additives

The use of additional engine oil additives could cause damage and invalidate the warranty.

Engine oil viscosity grades

The SAE viscosity grade gives information of the thickness of the oil.

Multigrade oil is indicated by two figures, e.g. SAE 5W-30. The first figure, followed by a W, indicates the low temperature viscosity and the second figure the high temperature viscosity.

Select the appropriate viscosity grade depending on the minimum ambient temperature.

All of the recommended viscosity grades are suitable for high ambient temperatures.

Coolant and antifreeze

Use only Lobrid antifreeze approved for the vehicle. Consult a workshop.

The system is factory filled with coolant designed for excellent corrosion protection and frost protection down to approx. -28 °C. In cold regions with very low temperatures the factory filled coolant provides frost protection down to approx. -37 °C. This concentration should be maintained all year round.

The use of additional coolant additives that intend to give additional corrosion protection or seal against minor leaks can cause function problems. Liability for consequences resulting from the use of additional coolant additives will be rejected.

Washer fluid

Use only washer fluid approved for the vehicle to prevent damage of wiper blades, paintwork, plastic and rubber parts. Consult a workshop.

Brake and clutch fluid

Over time, brake fluid absorbs moisture which will reduce braking effectiveness. The brake fluid should therefore be replaced at the specified interval.

Use only brake fluid approved for the vehicle. Consult a workshop.

AdBlue

Only use AdBlue to reduce the nitrogen oxides in the exhaust emission ↗ 132.

Technical data

Vehicle identification	240
Vehicle identification number ..	240
Identification plate	240
Engine identification	241
Vehicle data	242
Recommended fluids and lubricants	242
Engine data	243
Vehicle dimensions	245
Capacities	247
Tyre pressures	248

Vehicle identification

Vehicle identification number

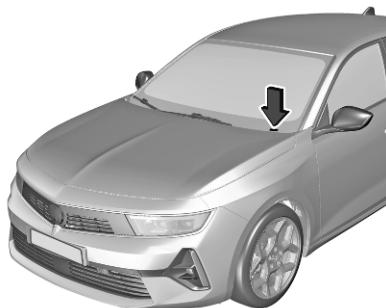

The Vehicle Identification Number may be embossed on the instrument panel, visible through the windscreen, or in the engine compartment on the right body panel.

Identification plate

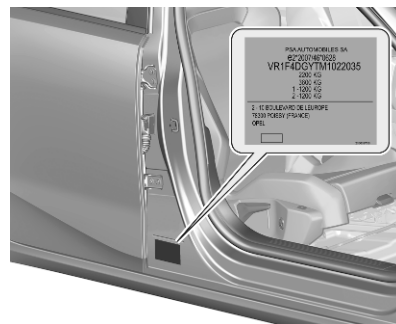

The identification plate is located on the front right door frame. The layout and position differ for some export countries.

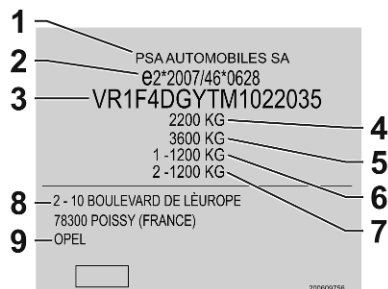

Information on identification label:

- 1** : manufacturer
- 2** : type approval number
- 3** : vehicle identification number
- 4** : permissible gross vehicle weight rating in kg
- 5** : permissible gross train weight in kg
- 6** : maximum permissible front axle load in kg
- 7** : maximum permissible rear axle load in kg
- 8** : manufacturer address, vehicle-specific or country-specific data
- 9** : vehicle brand

The combined total of front and rear axle loads must not exceed the permissible gross vehicle weight.

Vehicle's kerb weight depends on the specification of the vehicle, e.g. optional equipment and accessories. Refer to the EEC Certificate of Conformity provided with your vehicle or other national registration documents.

The technical data is determined in accordance with European Community standards. We reserve the right to make modifications. Specifications in the vehicle documents always have priority over those given in this manual.

Engine identification

The technical data tables show the engine identifier code.

Engine data ↗ 243.

To identify the respective engine, refer to the engine power in the EEC Certificate of Conformity provided with your vehicle or other national registration documents.

Vehicle data

Recommended fluids and lubricants

Required engine oil quality

Country groups ⇨ 235

Countries included in country groups 1 to 3 and 5

all engines

Vauxhall Original engine oil

B71 2010 / B71 2312

Engine oil viscosity grades

	B71 2010	B71 2312	B71 2302	B71 2297
Engine oil viscosity grade	SAE 0W-20	SAE 0W-30	SAE 0W-30	SAE 5W-30

Engine data

Engine identifier code	EB2ADT	EB2ADTS	EB2ADTSM	DV5RC	EP6FADTXHPD	EP6FADTXHPE
Sales designation	1.2 T	1.2 T	1.2 T	1.5 D	–	–
Piston displacement [cm ³]	1199	1199	1199	1498/1499	1598	1598
Engine power [kW]	81	96	96	96	133	110
at rpm	5500	5500	5500	3750	6000	6000
Torque [Nm]	205	230	230	300	250	250
at rpm	1750	1750	1750	1750	1750	1750
Fuel type	Petrol	Petrol	Petrol	Diesel	Petrol	Petrol
Octane rating RON ¹⁾²⁾						
recommended	95	95	91	–	95	95
possible	98	98	95	–	98	98
possible	91	91	–	–	91	91

1) A country specific label at the fuel filler flap can supersede the engine specific requirement.

2) In certain countries, the use of a particular fuel, e.g. a specific octane rating, may be required to ensure proper engine operation.

244 Technical data

Engine identifier code

Electric engine

Engine power [kW]

81.2

at rpm

2500

Torque [Nm]

320

at rpm

500-2500

Vehicle dimensions

	5-door Hatchback
Length [mm]	4374
Width with two exterior mirrors folded [mm]	1860
Width with two exterior mirrors [mm]	2062
Height (without antenna) [mm]	1441-1470 1442-1472 ³⁾
Length of load compartment floor [mm]	795 770 ³⁾
Length of load compartment with folded second row [mm] ⁴⁾	1589
Load compartment width between wheel arches [mm]	1020
Wheelbase [mm]	2675
Turning circle diameter [m]	10.51

3) hybrid vehicle

4) with front seat in middle longitudinal position

	Sports Tourer
Length [mm]	4642
Width with two exterior mirrors folded [mm]	1860
Width with two exterior mirrors [mm]	2062
Height (without antenna) [mm]	1443-1480 1443-1481 ⁵⁾
Length of load compartment floor [mm]	1026
Length of load compartment with folded second row [mm] ⁶⁾	1850
Load compartment width between wheel arches [mm]	1032
Wheelbase [mm]	2732
Turning circle diameter [m]	10.7

5) hybrid vehicle

6) with front seat in middle longitudinal position

Capacities

Engine oil

Engine	EB2ADT, EB2ADTS	EB2ADTSM	DV5RC	EP6FADTXHPE, EP6FADTXHPD
including filter [l]	3.5	3.6	3.8	4.3
between MIN and MAX [l]	1.1	1.1	1.6	1.2

Fuel tank

Petrol, refilling quantity [l]	52 42 ⁷⁾
Diesel, refilling quantity [l]	52

7) hybrid vehicle

AdBlue tank

AdBlue, refilling quantity [l]	13
--------------------------------	----

High voltage battery

Battery capacity [kWh]	12.4
------------------------	------

Tyre pressures

Tyres	Engine	Vehicle with up to 3 people		With full load	
		front [kPa/bar] ([psi])	rear [kPa/bar] ([psi])	front [kPa/bar] ([psi])	rear [kPa/bar] ([psi])
205/55 R16 94V	EB2ADT, EB2ADTS, EB2ADTSM, DV5RC	230/2.3 (33)	230/2.3 (33)	240/2.4 (35)	320/3.2 (46)
205/55 R16 91V NL	EB2ADT	230/2.3 (33)	210/2.1 (30)	240/2.4 (35)	310/3.1 (45)
205/60 R16 96H XL	EB2ADT, EB2ADTS, EB2ADTSM	220/2.2 (32)	220/2.2 (32)	240/2.4 (35)	320/3.2 (46)
	DV5RC	240/2.4 (35)	240/2.4 (35)	250/2.5 (36)	320/3.2 (46)
225/45 R17 94V XL	EB2ADT, EB2ADTS, EB2ADTSM	240/2.4 (35)	220/2.2 (32)	250/2.5 (36)	310/3.1 (45)
	DV5RC	240/2.4 (35)	230/2.3 (33)	250/2.5 (36)	310/3.1 (45)
	EP6FADTXHPE, EP6FADTXHPD	280/2.8 (41)	270/2.7 (39)	270/2.7 (39)	330/3.3 (48)

Tyres	Engine	Vehicle with up to 3 people		With full load	
		front	rear	front	rear
		[kPa/bar] ([psi])	[kPa/bar] ([psi])	[kPa/bar] ([psi])	[kPa/bar] ([psi])
225/40 R18 92Y XL	EB2ADT, EB2ADTS, EB2ADTSM	230/2.3 (33)	210/2.1 (30)	230/2.3 (33)	300/3.0 (44)
	DV5RC	230/2.3 (33)	220/2.2 (32)	230/2.3 (33)	300/3.0 (44)
	EP6FADTXHPE, EP6FADTXHPD	260/2.6 (38)	250/2.5 (36)	260/2.6 (38)	310/3.1 (45)

Customer information

Customer information	250
Declaration of conformity	250
REACH	250
Software update	250
Registered trademarks	252
Vehicle data recording and privacy	252
Event data recorders	252
Radio Frequency Identification (RFID)	255

Customer information

Declaration of conformity

Radio transmission systems

This vehicle has systems that transmit and / or receive radio waves subject to Directive 2014/53/EU and The Radio Equipment Regulations 2017 by the United Kingdom. The manufacturers of the systems declare conformity with

Directive 2014/53/EU and The Radio Equipment Regulations 2017. The full text of the EU declaration of conformity and information about operation frequency with maximum power for each system are available at the following internet address:
www.opel.com/conformity.

Importer is Vauxhall Motors Limited, MP UK 1-101-135, Chalton House, Luton Road, Chalton, Luton, Bedfordshire, LU4 9TT, United Kingdom.

REACH

Registration, Evaluation, Authorisation and Restriction of Chemicals (REACH) is a European Union regulation adopted to improve the protection of human health and the environment from the risks that can be posed by chemicals. Visit www.opel.com for further information and for access to the Article 33 communication.

Software update

The Infotainment system can download and install selected software updates over a wireless connection.

Notice

The availability of these over-the-air vehicle software updates varies by vehicle and country. Find more information on our website.

Remote device management and remote software and firmware updates

As an integral part of the service related to the performance of subscribed connected service contracts, necessary device management and necessary software and firmware updates related to the software and firmware for the named connected service will be performed remotely, in particular by using over-the-air technology.

For this, a secure radio network connection between the vehicle and the device management server will be established when ignition is switched on and a mobile network is available. Depending on the equipment of the vehicle, connection configuration must be set to **Connected vehicle** to allow the establishment of the radio network connection.

Irrespective of a valid connected service subscription, remote product security or product safety related device management and software and firmware updates will be performed when the processing is

necessary for the compliance with a legal obligation to which the manufacturer is subject (e.g. applicable product liability law, emergency call regulation) or when the processing is necessary in order to protect the vital interests of the respective vehicle users and passengers.

The establishment of a secure radio network connection and the related remote updates are not affected by privacy settings and will be performed in principal after an initiation by the vehicle user following a respective notification.

The system is able to notify receipt of an update as soon as it is connected to an exterior Wi-Fi network or a mobile network. Large updates are downloaded only via the Wi-Fi network.

The availability of an update is notified on the Info Display at the end of a trip with an option of immediate installation or postponement of installation.

The installation time is variable and can take several minutes with a maximum of about 30 minutes. A notification will give an estimate of the duration and a description of the update.

Updates can be checked manually via the Info Display. Follow the on-screen prompts in the respective menu.

Info Display ⇨ 86.

Notice

Steps for downloading and installing updates may vary by vehicle.

For safety reasons and because it requires sustained attention by the driver, the installation must be carried out with the ignition on without starting the engine. The installation cannot be carried out in the following cases:

- engine running
- emergency call in progress
- insufficient vehicle battery charge
- charging the vehicle's high voltage battery

Notice

During the installation process, the vehicle may not be operational.

If the update has failed, seek the assistance of a workshop.

Registered trademarks

Apple Inc.

Apple CarPlay™ is a trademark of Apple Inc.

App Store® and iTunes Store® are registered trademarks of Apple Inc.

iPhone®, iPod®, iPod touch®, iPod nano®, iPad® and Siri® are registered trademarks of Apple Inc.

Bluetooth SIG, Inc.

Bluetooth® is a registered trademark of Bluetooth SIG, Inc.

DivX, LLC

DivX® and DivX Certified® are registered trademarks of DivX, LLC.

Google Inc.

Android™ and Google Play™ Store are trademarks of Google Inc.

Velcro Companies

Velcro® is a registered trademark of Velcro Companies.

Verband der Automobilindustrie e.V.

AdBlue® is a registered trademark of the VDA.

Vehicle data recording and privacy

Event data recorders

Electronic control units are installed in your vehicle. Control units process data which is received by vehicle sensors, for example, or which they generate themselves or exchange amongst themselves. Some control units are necessary for the safe functioning of your vehicle, others assist you while you drive (driver assistance systems), while others provide comfort or infotainment functions.

The following contains general information about data processing in the vehicle. You will find additional information as to which specific data is uploaded, stored and passed on to third parties and for what purpose in your vehicle under the key word Data Protection closely linked to the references for the affected functional characteristics in the relevant owner's manual or in the general terms of sale. These are also available online.

Operating data in the vehicle

Control units process data for operation of the vehicle.

This data includes, for example:

- vehicle status information (e.g. speed, movement delay, lateral acceleration, wheel rotation rate, "seat belts fastened" display)
- ambient conditions (e.g. temperature, rain sensor, distance sensor)

As a rule such data is transient and is not stored for longer than an operational cycle, and only processed on board the vehicle itself. Often control units include data storage (including the vehicle key). This is used to allow information to be documented temporarily or permanently on vehicle condition, component stress, maintenance requirements and technical events and errors.

Depending on technical equipment levels, the data stored is as follows:

- system component operating states (e.g. fill level, tyre pressure, battery status)
- faults and defects in important system components (e.g. lights, brakes)
- system reactions in special driving situations (e.g. triggering of an airbag, actuation of the stability control systems)
- information on events damaging the vehicle
- for electric vehicles the amount of charge in the high-voltage battery, estimated range

In special cases (e.g. if the vehicle has detected a malfunction), it may be necessary to save data that would otherwise just be volatile.

When you use services (e.g. repairs, maintenance), the operating data saved can be read together with the vehicle identification number and used where necessary. Staff working for the service network (e.g. garages, manufacturers) or third parties (e.g.

breakdown services) can read the data from the vehicle. The same applies to warranty work and quality assurance measures.

Data is generally read via the OBD (On-Board Diagnostics) port prescribed by law in the vehicle. The operating data read documents the technical condition of the vehicle or individual components and assists with fault diagnosis, compliance with warranty obligations and quality improvement. This data, in particular information on component stress, technical events, operator errors and other faults, is transmitted to the manufacturer where appropriate, together with the vehicle identification number. The manufacturer is also subject to product liability. The manufacturer potentially also uses operating data from vehicles for product recalls. This data can also be used to check customer warranty and guarantee claims.

Fault memories in the vehicle can be reset by a service company when carrying out servicing or repairs or at your request.

Comfort and infotainment functions

Comfort settings and custom settings can be stored in the vehicle and changed or reset at any time.

Depending on the equipment level in question, these include

- seat and steering wheel position settings
- chassis and air conditioning settings
- custom settings such as interior lighting

You can input your own data in the infotainment functions for your vehicle as part of the selected features.

Depending on the equipment level in question, these include

- multimedia data such as music, videos or photos for playback in an integrated multimedia system
- address book data for use with an integrated hands-free system or an integrated navigation system

- input destinations
- data on the use of online services

This data for comfort and infotainment functions can be stored locally in the vehicle or be kept on a device that you have connected to the vehicle (e.g. a smartphone, USB stick or MP3 player). Data that you have input yourself can be deleted at any time.

This data can only be transmitted out of the vehicle at your request, particularly when using online services in accordance with the settings selected by you.

Smartphone integration, e.g. Android Auto or Apple CarPlay

If your vehicle is equipped accordingly, you can connect your smartphone or another mobile device to the vehicle so that you can control it via the controls integrated in the vehicle. The smartphone image and sound can be output via the multimedia system in this case. At the same time, specific information is transmitted to your smartphone. Depending on the type of integration,

this includes data such as position data, day / night mode and other general vehicle information. For more information, please see the operating instructions for the vehicle / infotainment system.

Integration allows selected smartphone apps to be used, such as navigation or music playback. No further integration is possible between smartphone and vehicle, in particular active access to vehicle data. The nature of further data processing is determined by the provider of the app used. Whether you can define settings, and if so which ones, is dependent on the app in question and your smartphone's operating system.

Online services

If your vehicle has a radio network connection, this allows data to be exchanged between your vehicle and other systems. The radio network connection is made possible by means of a transmitter device in your vehicle or a mobile device provided by you (e.g. a smartphone). Online functions can be used via this radio network connection. These include online services and applications / apps provided to you by the manufacturer or other providers.

Proprietary services

In the case of the manufacturer's online services, the relevant functions are described by the manufacturer in an appropriate location (e.g. Owner's Manual, the manufacturer's website) and the associated data protection information is provided. Personal data may be used to provide online services. Data exchange for this purpose takes place via a protected connection, e.g. using the manufacturer's IT systems provided for the purpose. Collection,

processing and use of personal data for the purposes of preparation of services take place solely on the basis of legal permission, e.g. in the case of a legally prescribed emergency communication system or a contractual agreement, or by virtue of consent.

You can activate or deactivate the services and functions (which are subject to charges to some extent) and, in some cases, the vehicle's entire radio network connection. This does not include statutory functions and services such as an emergency communication system.

Third party services

If you make use of online services from other providers (third parties), these services are subject to the liability and data protection and usage conditions of the provider in question. The manufacturer frequently has no influence over the content exchanged in this regard.

Therefore, please note the nature, scope and purpose of the collection and use of personal data within the scope of third party services provided by the service provider in question.

Radio Frequency Identification (RFID)

RFID technology is used in some vehicles for functions such as tyre pressure monitoring and immobiliser. It is also used in connection with conveniences such as radio remote controls for door locking / unlocking and starting. RFID technology in Vauxhall vehicles does not use or record personal information or link with any other Vauxhall system containing personal information.

Index

A

Accessories and vehicle modifications	203
Active emergency braking....	85, 159
Adaptive cruise control	152
AdBlue.....	83, 132
Adjustable air vents	119
Advanced lane keep assist..	82, 179
Airbag and belt tensioners	80
Airbag deactivation	45, 80
Airbag label.....	40
Airbag system	40
Air conditioning regular operation	121
Air intake	120
Air vents.....	119
Antilock brake system	143
Antilock brake system (ABS)	82
Anti-theft alarm system	21
Anti-theft locking system	20
Appearance care.....	232
Apply footbrake	84
Armrest.....	36
Ashtrays	73
Audio.....	109
Audio settings.....	109
Automatic anti-dazzle	25
Automatic crash notification.....	92
Automatic light control	95
Automatic locking	15

Automatic operation of electric parking brake off.....	82
Automatic post collision braking.	162
Automatic transmission	137
Automatic transmission electrified.....	135
Autostop.....	85, 127
Auxiliary heater.....	118

B

Basic operation.....	104
Battery discharge protection	102
BlueInjection.....	132
Bluetooth connection.....	111
Bonnet	207
Brake and clutch fluid.....	238
Brake and clutch system	81
Brake assist	145
Brake fluid	210
Brakes.....	210
Breakdown.....	230
Brightness.....	104
Bulb replacement	214

C

Capacities	247
Car wash mode.....	135
Catalytic converter	131
Central locking system	10
Centre console lighting	102
Centre console storage	55

Changing tyre and wheel size ...	219
Charging.....	189
Charging cable.....	187
Charging cable connected.....	84
Charging status.....	193
Charging system	80
Charging types.....	186
Child locks	15
Child restraint installation locations	50
Child restraints.....	46
Child restraint systems	46
Clock.....	71
Cold protection covers.....	203
Connected services.....	104
Connecting a phone.....	111
Connectivity.....	104
Control elements.....	103
Control elements overview.....	103
Control indicators.....	77
Control of the vehicle	123
Controls.....	68
Convex shape	23
Coolant and antifreeze.....	238
Cruise control	148
Cupholders	53
Curtain airbag system	45
Curve lighting.....	96
Curve speed adaptation.....	163

D

Danger, Warnings and Cautions ...	4
Daytime running lights	96
Declaration of conformity.....	250
DEF.....	132
Deflation detection system.....	84
Diesel exhaust fluid.....	132
Diesel fuel system bleeding	213
Display operation.....	104
Door open	85
Door panel storage.....	55
Doors.....	16
Drive modes.....	141
Driver alert.....	184
Driver assistance systems.....	147
Driver Information Centre.....	86
Driving characteristics and towing tips	198
Driving hints.....	123

E

Electric adjustment	23
Electrical system.....	215
Electric drive unit.....	135
Electric parking brake.....	143
Electric parking brake fault.....	82
Electronic climate control system	114
Electronic driving programmes ..	140
Electronic key system.....	9

Electronic Stability Control and Traction Control system....	83, 146
Emergencies.....	123
Emergency call.....	92
End-of-life vehicle recovery	206
Engine coolant	209
Engine coolant temperature	83
Engine coolant temperature gauge	76
Engine data	243
Engine exhaust	131
Engine identification.....	241
Engine oil	208, 238, 242
Engine oil level monitor.....	76
Engine oil pressure	84
Entry lighting	102
e-SAVE.....	86
Event data recorders.....	252
Exhaust filter.....	131
Exit lighting	102
Exterior care	232
Exterior light	85
Exterior lighting.....	94
Exterior mirrors.....	23
F	
Fault	140
First aid.....	62
First aid kit	62
Fixed air vents	120

Floor mats.....	234
Folding mirrors	24
Free wheeling.....	138
Front airbag system	43
Front fog lights	99
Front seats.....	31
Front storage.....	54
Fuel.....	193
Fuel consumption - CO ₂ - Emissions	197
Fuel for diesel engines	194
Fuel for petrol engines	193
Fuel gauge	75
Fuses	215

G

Gauges.....	74
Gear selection	138
Gear shifting.....	82
General information.....	185, 198
Glovebox	53

H

Hand brake.....	143
Hazard warning flashers	99
Headlight flash	96
Headlight range adjustment	96
Headlights.....	94
Headlights when driving abroad ..	96
Head restraints	30
Head-up display.....	88

Heated mirrors	24
Heated rear window	27
Heated steering wheel	68
Heated windscreen.....	28
Heating	36, 37
High beam	85, 95
High beam assist.....	85, 95
High voltage battery.....	206, 213
High voltage battery gauge.....	75
Hill start assist	146
Horn	69
Hybrid system active.....	81
Hybrid system fault.....	81

I

Identification plate	240
Ignition switch positions	124
Immobiliser	23
Indicators.....	77
Inductive charging.....	72
Info Display.....	86, 103
Instrument panel illumination control	101
Instrument panel overview	66
Interior care	233
Interior lighting.....	101, 104
Interior lights	101
Interior mirrors.....	25
Interruption of power supply	140
Introduction	3, 103

J

Jump starting	228
---------------------	-----

K

Keys	6
Keys, locks.....	6

L

Lane keep assist.....	82, 177
Lashing eyes	60
Lighting features.....	102
Light switch	94
Load compartment	16, 56
Load compartment cover	57
Loading information	63
Low beam.....	85
Low fuel	84

M

Malfunction indicator light	80
Manual anti-dazzle	25
Manual mode	139
Manual seat adjustment.....	32
Manual transmission	141
Massage.....	37
Matrix-LED headlights.....	96
Misted light covers	101
Mobile phones and CB radio equipment	112

N			
Navigation system	110	Power indicator gauge.....	75
New vehicle running-in	124	Power outlets	71
O		Power seat adjustment	34
Object detection systems.....	164	Power steering.....	82
Odometer	74	Power windows	26
Oil, engine.....	238, 242	Preheating	83
Outside temperature	71	Privacy settings.....	104
Overrun cut-off	127	Profiles.....	108
P		Programmable charging.....	192
Pairing a phone.....	111	Puncture.....	225
Panoramic sunroof.....	28	Q	
Panoramic view system.....	168	Quickheat.....	118
Parking	130	R	
Parking assist	83, 164	Radio.....	109
Parking brake.....	81, 143	Radio Frequency Identification (RFID).....	255
Parking lights	100	Radio remote control	7
Particulate filter.....	131	REACH.....	250
Pedestrian safety alert.....	69	Reading lights	101
Pedestrian safety alert fault.....	85	Rear cross traffic alert.....	174
Performing work	207	Rear floor storage cover	60
Personalisation.....	107	Rear fog light	85, 100
Phone		Rear view camera	171
Bluetooth connection.....	111	Rear window wiper and washer . .	71
Phone projection.....	112	Recommended fluids and lubricants	238, 242
Playing audio.....	109	Refuelling	195
Post collision braking.....	162	Regenerative braking.....	146
Power button.....	124	Registered trademarks.....	252
Powerflow.....	86	Reversing lights	100
		Ride control systems.....	146
		Roadside assistance.....	92
		Roof.....	28
		Roof load.....	63
		Roof rack	62
		Route guidance.....	110
		S	
		Safety net	61
		Seat belt reminder	79
		Seat belts	38
		Seat heating.....	36, 37
		Seat position	31
		Seat ventilation.....	36
		Selective catalytic reduction.....	132
		Selector lever.....	138
		Semi-automated lane change... .	182
		Service	121, 235
		Service display	76
		Service information	235
		Service vehicle soon	81
		Side airbag system	44
		Side blind spot alert.....	166, 174
		Sidelights.....	94
		Smart access.....	10, 124
		Smartphone	
		Phone projection.....	112
		Software update.....	250
		SOS.....	92

Sound settings.....	109
Spare wheel	225
Speech recognition.....	111
Speed limiter.....	150
Speed limit recognition	148, 150, 152
Speedometer	74
Starting and operating.....	124
Starting the engine	126
Status bar.....	104
Steering.....	123
Steering wheel adjustment	68
Steering wheel controls	68, 103
Stop engine.....	81
Stop-start system.....	127
Storage.....	53
Storage compartments.....	53
Sunroof	28
Sunvisor lights	101
Sun visors	28
Symbols	4
System settings.....	104
System updates.....	104
T	
Tachometer	74
Tailgate.....	16
Temperature preconditioning.....	118
Three-point seat belt	39
Tools	215
Total vehicle range.....	76

Tow bar.....	198
Towing.....	198, 230
Towing another vehicle	231
Towing equipment	199
Towing the vehicle	230
Traffic sign assistant.....	175
Trailer coupling.....	198
Trailer stability assist	202
Trailer towing	198
Transmission display	137
Tread depth	219
Trip computer	90
Turn lights	79, 99
Tyre chains	220
Tyre deflation detection system ..	218
Tyre designations	216
Tyre pressure	217
Tyre pressures	248
Tyre repair kit	220

U

Ultrasonic parking assist.....	164
Updates.....	104
Upholstery.....	233
USB port.....	71
User profiles.....	108
Using smartphone applications. .	112
Using this manual	3

V

Vauxhall Connect.....	92
Vehicle battery	211
Vehicle checks.....	207
Vehicle data.....	242
Vehicle data recording and privacy.....	252
Vehicle dimensions	245
Vehicle identification number ..	240
Vehicle jack.....	215
Vehicle locator lighting.....	102
Vehicle messages	89
Vehicle personalisation	91
Vehicle security.....	20
Vehicle specific data	3
Vehicle storage.....	204
Vehicle tools.....	215
Ventilating.....	36
Voice assistant.....	111
Voice recognition.....	111

W

Warning chimes	90
Warning lights.....	77
Warning triangle	62
Washer fluid	210
Wheel changing	223
Wheel covers	219
Wheels and tyres	216
Wi-Fi.....	104

Windows.....	26
Windscreen.....	26
Windscreen wiper and washer	69
Winter tyres	216
Wiper blade replacement	214

Copyright by Vauxhall Motors Ltd.

The information contained in this publication is effective as of the date indicated below. Vauxhall Motors Ltd. reserves the right to make changes to the technical specifications, features and design of the vehicles relative to the information contained in this publication, as well as changes to the publication itself.

Edition: April 2022, Vauxhall Motors Ltd.

Printed on chlorine-free bleached paper.

ID-VASLORIE2204-en

