



Owner's Manual

ASTRA

Operation, Safety and Maintenance



ASTRA

Contents

Commitment to customer satisfaction:

Our aim: to keep you happy with your vehicle. All Vauxhall Authorised Repairers offer first-class service at competitive prices. Experienced, factory-trained technicians work according to factory instructions. Your Authorised Repairer can supply you with GENUINE VAUXHALL-APPROVED PARTS, which have undergone stringent quality and precision checks, and of course useful and attractive VAUXHALL-APPROVED ACCESSORIES.

Our name is your guarantee!

For details of the

Vauxhall Authorised Repairer Network, please ring this number; 0845 090 2044

In brief	2
Keys, doors, windows, TwinTop	30
Seats, interior	64
Instruments, controls	112
Lighting	143
Infotainment system	151
Climate control	154
Driving and operation	176
Self-help, vehicle care	241
Service, maintenance	294
Technical data	308
Index	352

In brief

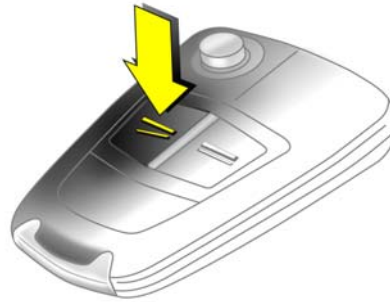

16968 T

**To unlock and open the vehicle:
Press button , pull door handle**

► Door locks – see page 49,
keys – see page 30,
electronic immobiliser – see page 31,
remote control – see page 32,
central locking system – see page 40,
anti-theft locking system * – see page 41,
Vauxhall alarm system * – see page 46,
TwinTop roof operation * – see page 56,
child safety locks – see page 49.



S 12071

**To unlock and open the vehicle
with the Open&Start System *:
Bring electronic key into the
reception area of the vehicle,
pull handle**

► Open&Start System * – see page 34.

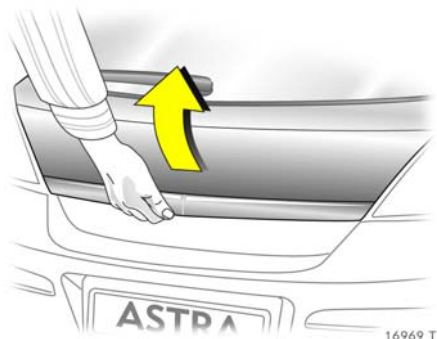

To unlock and open the luggage compartment:
**Press button \geq on remote control, or for the Open&Start System \ast :
 Bring electronic key into the reception area of the vehicle, pull button below handle**

► Open&Start-System \ast – see page 34,
 remote control – see page 32,
 central locking system – see page 40,
 Vauxhall alarm system \ast – see page 46.



S 11510

To adjust front seat:
Pull handle, slide seat, release handle

► Seat – see page 64,
 seat position – see page 67.

Warning

Important: Do not sit nearer than 10 inches (25 cm) from the steering wheel, to permit safe airbag deployment.



S 11511

Adjust front seat backrests:
Turn handwheel

Move backrest to suit seating position.

Do not lean on seat backrest whilst adjusting it.

► Seats – see page 64,
 seat position – see page 67,
 fold front passenger seat backrest – see pages 66, 75.

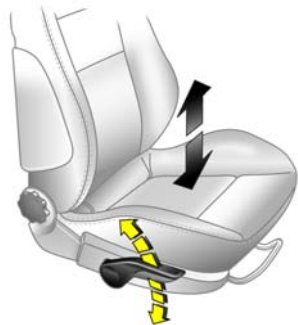

S 11512

**To adjust front seat height *:
Operate lever on outboard side
of seat**

Pump action on lever

Up: Seat higher

Down: Seat lower

► Seat – see page 64,
seat position – see page 67.

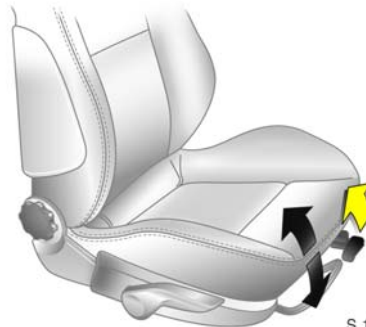

S 11513

**To adjust front seat inclination *:
Pull inner lever on front of seat,
adjust inclination, release lever,
engage seat in position**

Adjust the inclination by distributing body weight.

► Seat – see page 64,
seat position – see page 67.

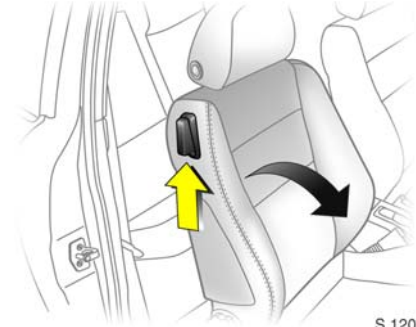

S 12057

**Tip the front seat backrests
forward *:
Lift release lever,
tilt backrest forward,
lower release lever,
seat back is engaged
in tilted position *,
slide seat forwards ***

To straighten the seat, slide back and it engages in its original position *. Raise release lever *, straighten backrest, lower release lever, backrest engages.

The backrest can only be tipped forwards from an upright position.

Panoramic windscreen *: before folding the seat, push the head restraints down and close the sun visors.

► Seats – see page 64,
fold front passenger seat backrest –
see pages 66, 75.

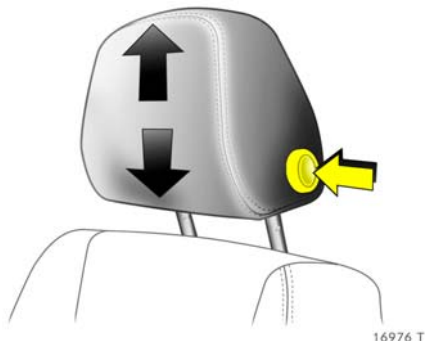

16976 T

To adjust head restraint height of front and rear outboard seats: Press button to release, adjust height, engage in position

► Head restraints – see page 68, head restraint position – see page 69, adjust rear centre head restraint – see page 68, head restraint removal – see page 69.



18533 T

To fit seat belt: Draw seat belt smoothly from inertia reel, guide over shoulder and engage in buckle

The entire length of the seat belt must be twist-free. The lap belt must lie closely against the body. The seat backrests must not be tilted too far backwards (maximum recommended tilting angle approx. 25°).

To release belt, press red button on belt buckle.

► Three-point seat belts – see page 85, airbag system – see page 92, seat position – see page 67.

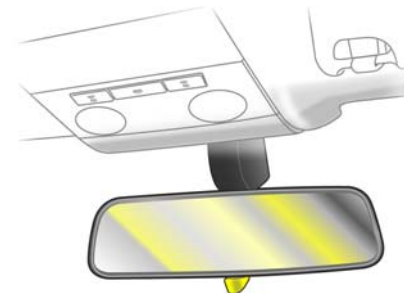

S 11514

Adjusting interior mirror: Swivel mirror housing

Swivel lever on underside of mirror housing to reduce dazzle at night.

► Mirrors – see page 49, automatic dipping interior mirror – see page 51.



**To adjust exterior mirrors manually:
From inside, swivel lever in required direction**

► Mirrors – see page 49,
aspherically curved exterior mirror – see page 49,
folding exterior mirror – see page 50,
heated exterior mirror – see page 157.

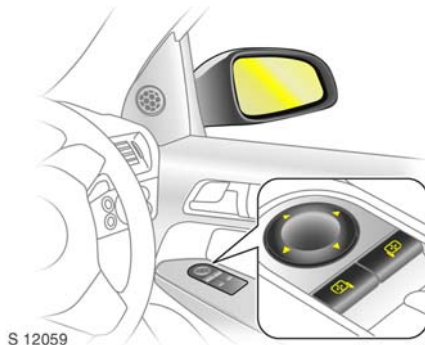

**Electrical exterior mirrors *
adjust:
Four-way switch in driver's door**

Press right or left mirror switch: four-way switch controls the appropriate mirror.
Centre position: no adjustment.

► Mirrors – see page 49,
aspherically curved exterior mirror – see page 49,
folding exterior mirror – see page 50,
heated exterior mirror – see page 157.

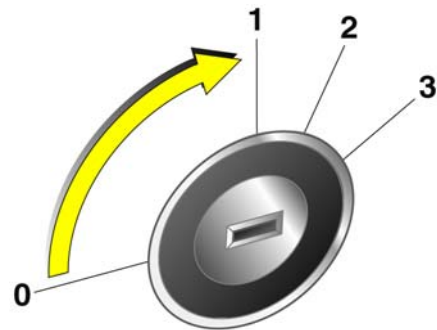

**Steering column lock and ignition:
Turn key to position 1;
disengage steering column lock
by moving steering wheel slightly**

Positions:

- 0 = Ignition off
- 1 = Steering free, ignition off
- 2 = Ignition on, with diesel engine: preheating
- 3 = Starting

► Starting – see page 17,
electronic immobiliser – see page 31,
parking the vehicle – see page 18.

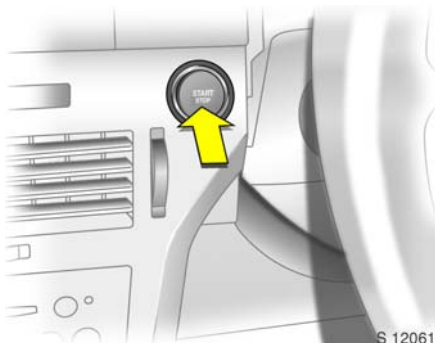

S 12061

Steering column lock and ignition on vehicles with Open&Start system *:
Make sure electronic key is in the interior reception range and press the Start/Stop button;
disengage the steering column lock by moving the steering wheel slightly

To start the vehicle, also operate brake or clutch pedal.

To activate the steering column lock, switch ignition off by pressing the Start/Stop button, open driver's door and engage steering wheel. Do not allow vehicle to move while doing this.

► Starting – see page 17,
 electronic immobiliser – see page 31,
 parking the vehicle – see page 18.

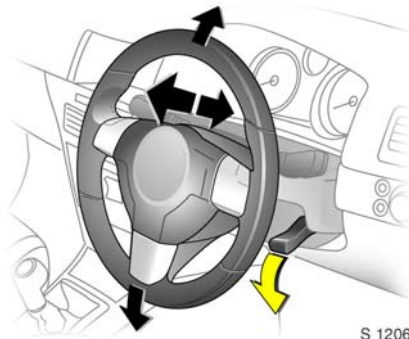

S 12062

Steering wheel adjustment:
Move lever down,
adjust height and distance,
move lever up, engage

Adjust steering wheel only when vehicle is stationary and steering column lock is released.

► Airbag System – see page 92.



16986 T

Turn light switch:

- 0** = Off
- D** = Parking lights
- D** = Dipped beam or main beam
- AUTO** = Automatic dipped beam activation *

Press button:

- D** = Fog lights *
- D** = Fog tail light





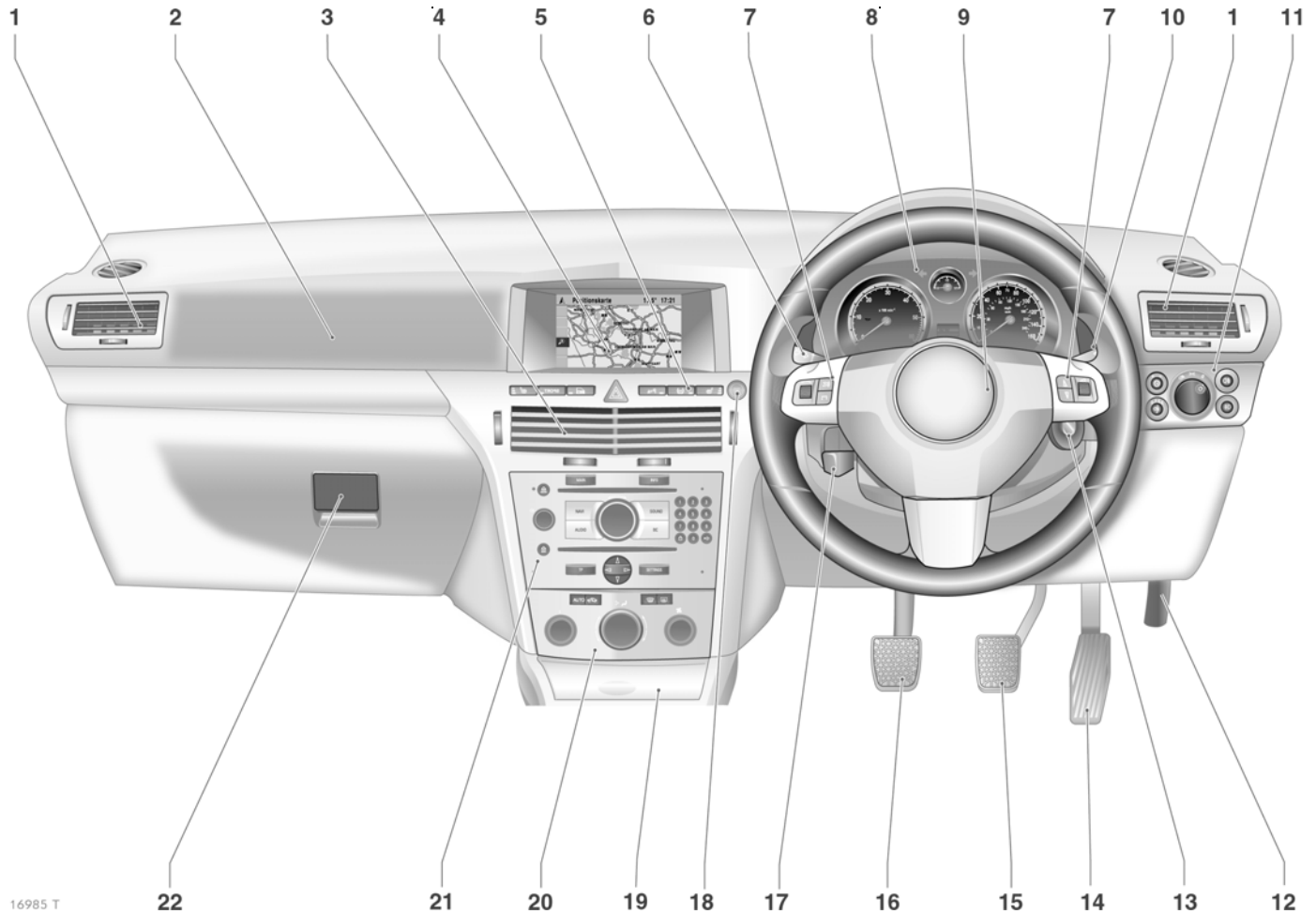























► Lighting – see page 143,
 headlight control indicator –
 see pages 18, 140.

8 In brief



	Page		Page		Page	
1	Side air vents	156	7	Remote control on steering wheel *	151	
2	Front passenger airbag	93	8	Instruments	112	
3	Centre air vents	156	9	Horn	12	
4	Central information display for time, date, outside temperature, Infotainment system *, Check control *	138		Driver's Airbag	93	
	Trip computer *	128, 134	10	Windscreen wiper, windscreen wash system, headlight wash system * and rear window wash system	12, 13, 141	
	Climate control system *	168	11	Parking lights, dipped beam	143	
5	Heated seat (left) *	157		Instrument illumination	148	
	Deflation detection system *	218		Fog tail light	145	
	Tyre pressure monitoring system *	219		Fog lights *	145	
	Parking distance sensor *	215		Headlight range adjustment *	146	
	Hazard warning lights	11	12	Unlocking the bonnet	241	
	Central locking system	42	13	Starter switch with immobiliser	6 and sensor panel for emergency operation Open&Start system *	37
	SPORT mode *	212				
	Heated seat (right) *	157				
6	Turn signal light	11				
	Headlight flash, Dipped beam, high beam	11				
	Door-to-door light function *	148				
	Cruise control *	213				
			14	Accelerator pedal	198, 199	
			15	Brake pedal	199, 223	
			16	Clutch pedal *	199	
			17	Steering wheel adjustment	7	
			18	Start/stop button *	17, 34	
			19	Ashtray *	108	
				Cigarette lighter *	107	
			20	Climate control	154	
			21	Infotainment system *	151	
			22	Glove compartment	37, 110, 156	

Control indicators

-  **Open&Start system, fault,**
see pages 34, 112.
-  **Engine oil pressure,**
see page 113.
-  **Brake system, clutch system,**
see pages 114, 223, 302.
-  **Airbag systems, belt tensioners,
deployable anti-roll bars ***
see pages 87, 98, 104.
-  **Electronic Stability Programme
(ESP[®] Plus) ***
see page 210.
-  **Seat belt ***
see pages 88, 114.
-  **Open doors and luggage
compartment,**
see page 115.
-  **Alternator,**
see page 115.
-  **Coolant temperature,**
see pages 115, 300.
-  **Engine electronics, gearbox
electronics *, immobiliser,
diesel fuel filter *, fault,**
see pages 31, 115, 182, 188,
196, 206.
-  **Easytronic *, start engine *,**
see pages 115, 177.
- IDS+** **Continuous Damping Control *,
SPORT mode *,**
see pages 212, 213.
-  **Engine oil level *,**
see pages 116, 298.
-  **Exterior lights,**
see pages 116, 143.
-  **Parking distance sensor *,**
see page 215.
-  **Turn signal lights,**
see pages 11, 116.
-  **Fuel level,**
see pages 116, 119, 202.
-  **Fog lights *,**
see pages 117, 145.
-  **Main beam,**
see pages 11, 117.
-  **Fog tail light,**
see pages 117, 145.
-  **Winter programme of
automatic transmission * or
Easytronic *,**
see pages 180, 186, 193.
-  **SPORT mode of automatic
transmission * or Easytronic *,**
see pages 179, 185, 192.
-  **Seat occupancy recognition *,**
see page 99.
-  **Exhaust emission *,**
see pages 117, 206.
-  **Anti-lock Brake System,**
see page 225.
-  **Preheating system *,
diesel particle filter *,**
see page 118.
-  **Deflation detection system *,
tyre pressure monitoring
system *,**
see pages 118, 219, 221.
-  **Adaptive Forward Lighting
(AFL) *, fault,**
see pages 147, 150.
-  **Cruise control *,**
see page 214.

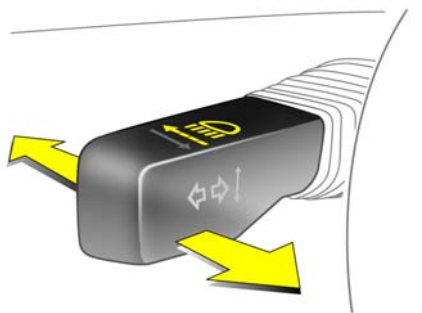

16987 T

Headlight flash, main beam and dipped beam:

Headlight flash = Pull stalk toward steering wheel

Main beam = Push stalk forward

Dipped beam = Push stalk forward again or pull toward steering wheel

► Main beam, headlight flash – see page 144.

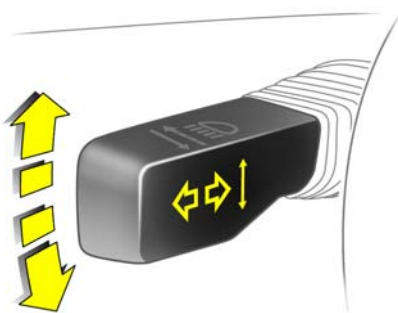

16989 T

Switch on turn signal lights:

Right = Move stalk up

Left = Move stalk down

► Turn signal lights – see page 144.

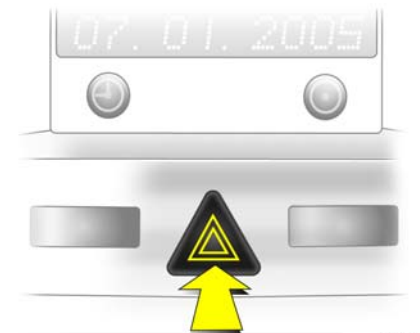

16991 T

Hazard warning lights:

On = Press ▲

Off = Press ▲ again

► Hazard warning lights – see page 146.

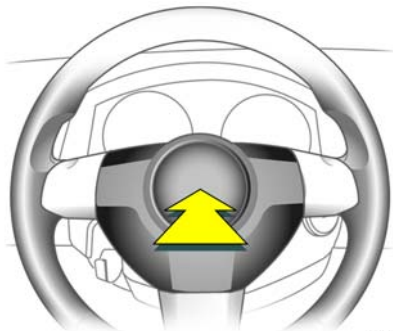

16992 T

Activate horn:
 Press  in centre of steering wheel

► Airbag system – see page 93, remote control on steering wheel  – see page 151.

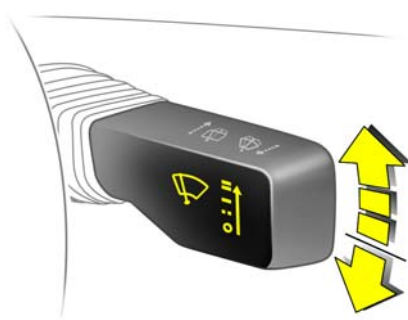

16993 T

Windscreen wiper:
 Move stalk up slightly

- = Off
- = Timed interval wipe
- = Slow
- ≡ = Fast

Move stalk down from position ○: Single swipe.

► Windscreen wiper – see page 141, adjustable wiper interval  – see page 141, wiper blades – see pages 303, 304, vehicle care – see page 291.

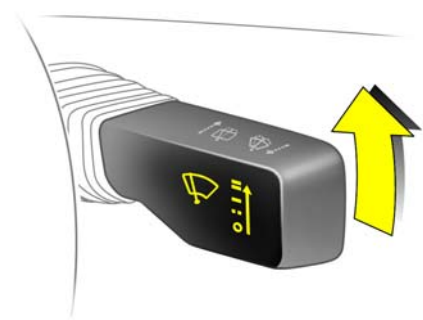

16995 T

Automatic wiping with rain sensor :

- Move stalk up slightly
- = Automatic wiping with rain sensor
- = Off

► Windscreen wiper – see page 141, wiper blades – see pages 303, 304, vehicle care – see page 291.

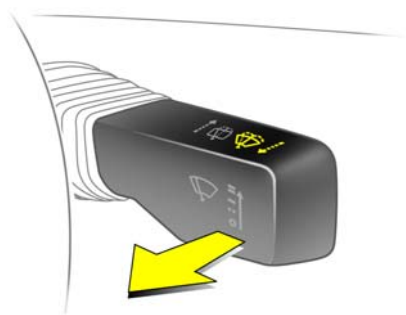

16996 T

Operating windscreen and headlight wash systems *: Pull stalk toward steering wheel

► Windscreen and headlight wash systems – see page 142, further notes – see pages 291,303

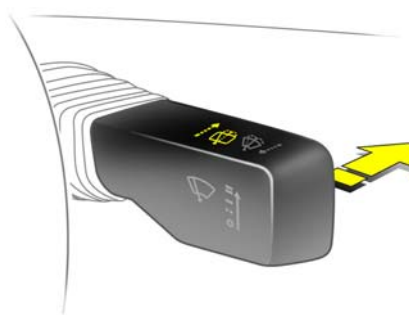

16997 T

Activate rear screen wiper * and wash system *:

- Wiper on** = Push stalk forward
- Wiper off** = Push stalk forward again
- Wash** = Hold stalk pushed fully forward

► Rear screen wiper and wash system – see page 142, further notes – see pages 291, 303.



16998 T

Heated rear window, heated exterior mirrors:

- On** = Press 
- Off** = Press  again

► Air conditioning – see page 154, heated rear window – see page 157.



To demist or defrost windows:

Set air distribution to , rotary switch for temperature and air flow clockwise;

Air conditioning system : also press button ;

Automatic air conditioning system :

press buttons  and ,

turn rotary switch for temperature clockwise, air flow to A;

Climate control system :

press button 

► Climate control system  – see page 154.



Set automatic mode on climate control system :

Press AUTO,

pre-select temperature with rotary switch, open air vents

► Climate control system  – see page 168.



S 11521

Manual transmission:

Reverse: with the vehicle stationary, 3 seconds after de-clutching pull the button up on the selector lever and engage gear.

If the gear does not engage, set the lever in neutral, release the clutch pedal and depress again; then repeat gear selection.

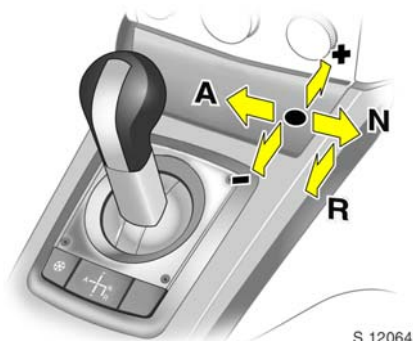

S 12064

Easytronic *:

- N** = Idling
- = Drive position
- +** = Higher gear
- = Lower gear
- A/M** = Switch between Automatic and Manual mode
- R** = Reverse gear (with selector lever lock)

Always move selector lever as far as it will go in the chosen direction.

It automatically returns to the centre position after every operation. Observe gear/mode indicator in transmission display.

The footbrake must be depressed when starting.

► Easytronic * – see page 176.

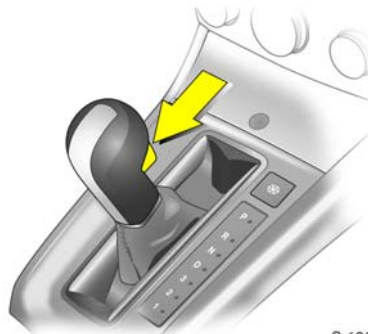

S 12065

Automatic transmission *:

- P** = Park position.
- R** = Reverse gear.
- N** = Neutral (idle)
- D** = Automatic gear selection
- 3** = 1st to 3rd gear
- 2** = 1st and 2nd gear
- 1** = 1st gear

P or N must be engaged when starting.

To exit **P**, switch ignition on, operate footbrake and press button on selector lever.

Press button on selector lever to engage **P** or **R**.

P Only when vehicle is stationary, first apply handbrake

R Only when vehicle is stationary

► Automatic transmission * – see page 184.



S 12066

Automatic transmission with ActiveSelect *:

P = Park position

R = Reverse gear

N = Neutral (idle)

D = Automatic gear selection

Selector lever in D to left: Manual mode

+ = Higher gear

- = Lower gear

P or N must be engaged when starting.

To move from **P** or **N**, switch on ignition, depress footbrake and press button on selector lever.

To select **P** or **R**, press button on selector lever.

P Only when vehicle is stationary, first apply handbrake

R Only when vehicle is stationary

► Automatic transmission with ActiveSelect * – see page 190.

Before starting off, check:

- Tyre pressure and tyre condition – see pages 227, 337.
- Engine oil level and fluid levels in engine compartment – see pages 298 to 305.
- All windows, mirrors, exterior lighting and number plates are free from dirt, snow and ice and operational.
- Do not place any objects in front of the rear window, on the instrument panel or in the area in which the airbags inflate.
- Seats, seat belts and mirrors are correctly adjusted.
- Brake function.

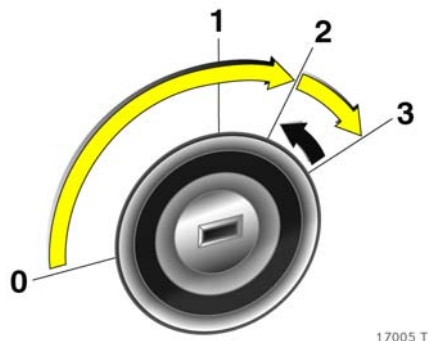

17005 T

To start engine:

Operate clutch and brake,
automatic transmission *
in P or N,

Easytronic *: Depress brake,
do not accelerate;

Petrol engine: Turn key to 3;

Diesel engine: Turn key to 2,

when control indicator 

goes out¹⁾ turn key to 3;

release key once engine
is running

Before restarting or switching off the
engine, turn key back to 0.

To switch on the ignition, only turn the
key to 2.

► Electronic immobiliser – see page 31,
diesel fuel system – see page 242.

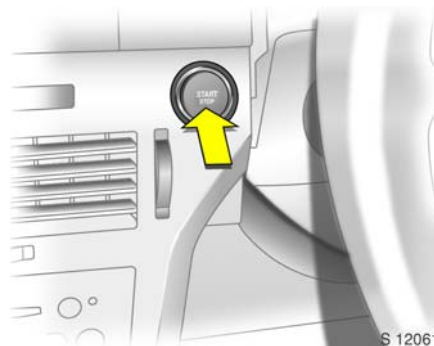

S 12061

To start engine with Open&Start system *:

The electronic key must be inside
reception area inside the car,

operate clutch or brake,
automatic transmission *
in P or N,

Easytronic *: Depress brake,

do not accelerate;

Petrol engine: Press button;

Diesel engine: Briefly press
button, when control indicator 

goes out¹⁾ press button again
for 1 second;

release button once engine
is running

Press button again to repeat the starting
procedure or switch off the engine.

To turn on the ignition, do not press the
brake or clutch pedal; just press the button
briefly.

Do not start unless vehicle is stationary.

► Open&Start-System * – see page 34,
electronic immobiliser – see page 31,
diesel fuel system – see page 242.

¹⁾ Preheating system switches on only if outside
temperature is low.

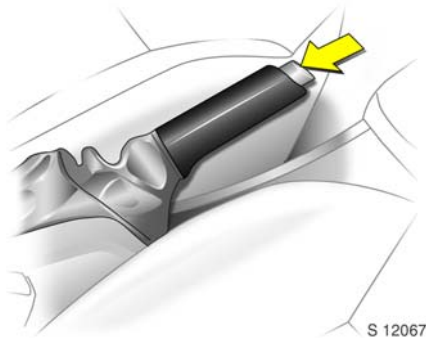

S 12067

**Releasing the handbrake:
Raise lever slightly,
press release button,
lower lever fully**

► Handbrake – see page 224.

Parking the vehicle

- Always apply handbrake without pressing release button. Apply as firmly as possible on a downhill slope or uphill slope. Operate footbrake at same time to reduce operating force.
- Switch engine off by turning ignition key to 0. Remove ignition key and turn steering wheel until steering lock is felt to engage (anti-theft protection). With Open&Start system * switch ignition off and open driver's door.

In vehicles with Open&Start system * the engine can only be switched off when the vehicle is stationary.

In vehicles with automatic transmission * the key can only be withdrawn when the selector lever is in position P. With the Open&Start System *, "P" flashes in the gear display for several seconds if P is not selected or the handbrake is not applied.

- If the vehicle is on a level surface or an incline, with manual transmission or Easytronic * select first gear before switching the ignition off, with automatic transmission * move selector lever to P. Also turn wheels away from kerb on an uphill slope.

If the vehicle is on a downhill slope, with manual transmission or Easytronic * select reverse gear before turning the ignition off, with automatic transmission * move selector lever to P. Also turn front wheels toward kerb.

- Lock doors and luggage compartment using button = on remote control and with Open&Start system * touch sensor in door handle of front door.

To activate the anti-theft locking system * and the Vauxhall alarm system * press button = twice or with Open&Start system * touch sensor in one of the front door handles twice.

Advice when parking:

- Do not park the vehicle on an easy flammable surface. The high temperature of the exhaust system could ignite the surface.
- On vehicles with Easytronic * control indicator (D) flashes for a few seconds after the ignition is switched off if the handbrake has not been applied – see page 182.
- Close the windows and sunroof * or TwinTop *.
- The engine cooling fans may run after the engine has been switched off – see page 297.
- ▶ Remote control – see page 32,
Open&Start system – see page 34,
central locking system – see page 40,
Vauxhall alarm system * – see page 46,
TwinTop roof operation * – see page 56,
parking up the vehicle – see page 307.

That was the most important information in brief for your first drive in your vehicle.

The other pages of this chapter contain a summary of the noteworthy functions of your vehicle.

The remaining chapters of the Owner's Manual contain important information on operation, safety and maintenance as well as a complete index.

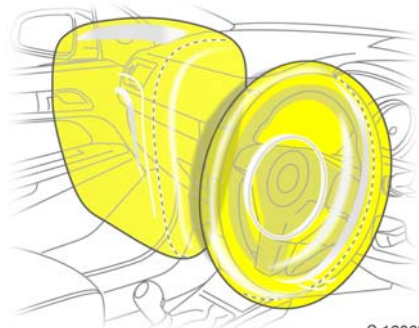

S 12069

Vauxhall Full Size airbag system

The Vauxhall Full Size airbag system consists of several separate systems.

Front airbag system

The front airbag system will be triggered in the event of a serious accident involving a frontal impact and forms safety cushions for the driver and front passenger. The forward movement of the driver and front passenger is checked and the risk of injuries to the upper body and head thereby substantially reduced.

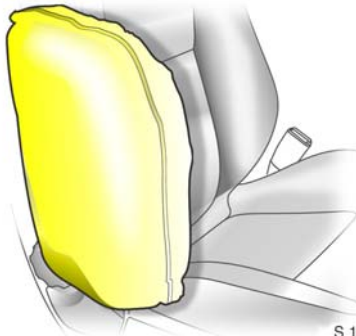

S 11546

Side airbag system ❄

The side airbag is triggered in the event of a side-on collision to form a safety cushion for the driver or front passenger in the respective door area. This substantially reduces the risk of injury to the upper body and pelvis.

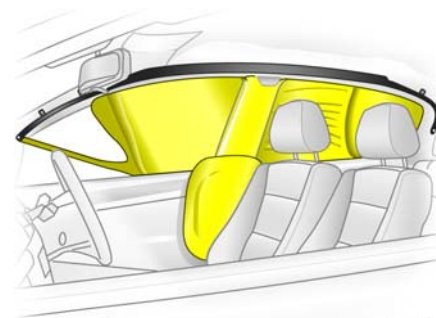

S 12070

Curtain airbag system ❄

The curtain airbag system triggers in case of a side-on collision and provides a safety barrier in the head area on the respective side of the vehicle. This reduces the risk of injury to the head considerably in case of a side-on collision.

► Vauxhall Full Size airbag system – see page 92.

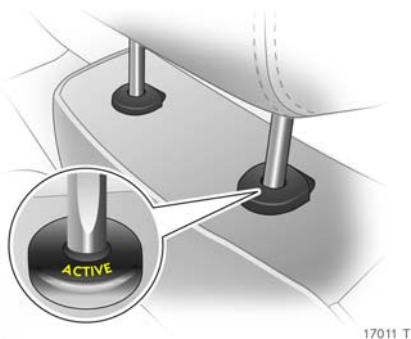

17011 T

Active headrests * on front seats

In the event of a rear-end impact, the active head restraints tilt forward a little. The head is more effectively supported by the head restraint and the danger of whiplash in the neck area is reduced.

Active head restraints are identified by the lettering **ACTIVE** on the head restraint guide sleeves.

► Headrests – see page 68.

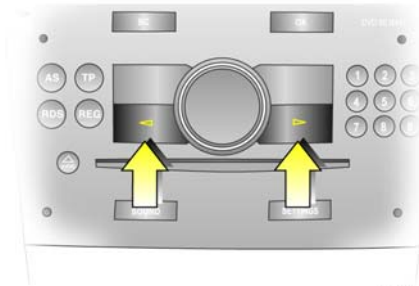

S 13209

Operating menus in the information display *

Menu options are selected using menus and the arrow keys or the multi-function button on the Infotainment system * or the left-hand adjuster wheel * on the steering wheel. The selected menu options are shown on the display.

Selection using arrow keys *: Operate left or right arrow key.



17013 T

Selection using multi-function button *: rotate and press multi-function button.

To exit a menu, turn the multi-function button left or right to **Return** or **Main** and select.



17014 T

Selection with left adjuster wheel on steering wheel ✱: rotate adjuster wheel and press.

► Information Display – see page 122.

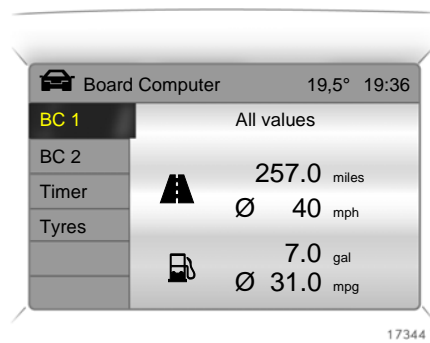

17344 T

Trip computer ✱

The trip computers provide information on driving data, which is continually recorded and evaluated electronically.

Functions:

- Range
- Instantaneous consumption
- Distance travelled
- Average speed
- Effective consumption
- Average consumption
- Stop watch
- Tyre pressure ✱

► Trip computer ✱ – see pages 128, 134.

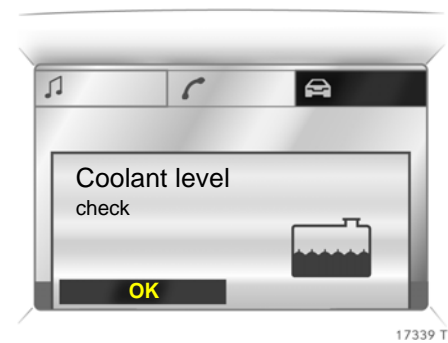

17339 T

Check control ✱

The check control software monitors

- Fluid levels
- Tyre pressure ✱
- Remote control battery
- Vauxhall alarm system ✱
- Important exterior lights, including cables and fuses

► Check Control ✱ – see page 138.

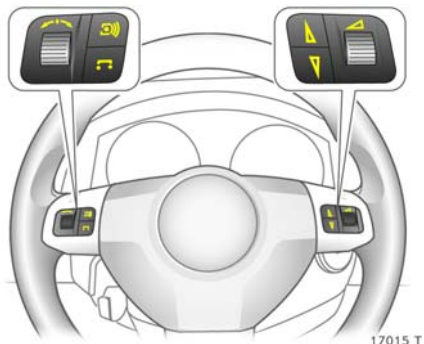

17015 T

Remote control on steering wheel *

The functions of the infotainment system and the information display can be operated with the buttons and adjuster wheels on the steering wheel.

Further information is available in the infotainment system operating instructions.

► Remote control on steering wheel * – see page 151, Infotainment System – see page 151.



17026 T

Twin Audio *

Twin Audio allows rear seat occupants the choice between the audio source played on the infotainment system or a separate audio source.

Only an audio source that is not currently active on the infotainment system can be controlled using Twin Audio.

Two headphone connections are available, with separate volume controls.

Further information is available in the infotainment system operating instructions.

► Twin Audio * – see page 152.



S 12071

Open&Start system with electronic key and remote control *

The Open&Start system allows the vehicle to be locked and unlocked, including anti-theft locking system * and the Vauxhall alarm system * without a mechanical key and the engine to be started and stopped using a start/stop button. All the driver has to do is carry the electronic key around with him.

► Open&Start System * – see page 34.

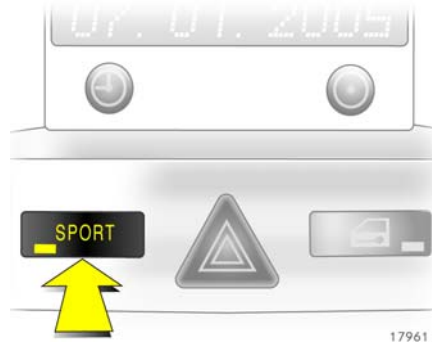

17961 T

Sport mode *

To activate

Press the **SPORT** button. The LED in the button illuminates.

SPORT mode is used to change damping *, steering *, throttle application and the shift point for Easytronic * and automatic transmission * while driving.

Damping and steering become more direct and provide better contact with the road surface. The engine reacts more quickly to accelerator movements.

With Easytronic * and automatic transmission *, the shift times are shortened and shifting takes place at higher revs (not with cruise control enabled *).

► Sport mode * – see page 212.



17018 T

Deflation Detection System (DDS) *

The deflation detection system continuously monitors the speed of all wheels while driving. If a tyre loses pressure, it grows smaller and therefore rotates more quickly than the other wheels. If the system detects a difference in speed, the control indicator (⚠) illuminates in red.

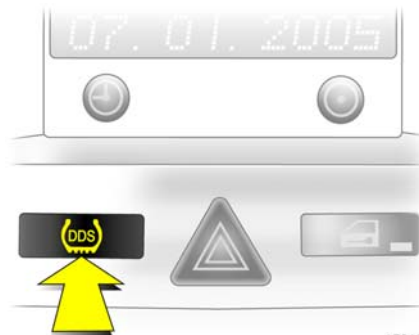

17019 T

After tyre pressure is corrected or a tyre or wheel is changed, the system must be initialised by pressing the DDS button.

► Tyre deflation detection system * – see page 218.

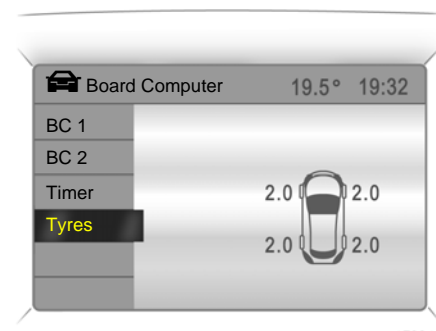

17334 T

Tyre pressure monitoring system *

The tyre pressure monitoring system continually checks the pressure and speed of all four wheels while driving.

A pressure sensor is installed in each wheel. The inflation pressures of the individual wheels are transmitted to a controller, where they are compared.

The current tyre pressures can be displayed on the graphical information display or the colour information display *.

Deviating tyre pressures are displayed in the form of messages on the information display whilst driving.

► Tyre pressure monitoring system * – see page 218.

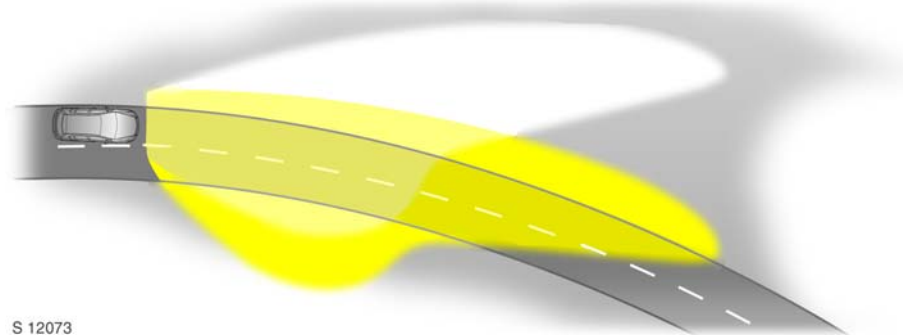

S 12073

Adaptive Forward Lighting (AFL) *

improves lighting in curves (curve lighting) on vehicles with Bi-Xenon headlight system.

Curve lighting

The Xenon light beam pivots based on steering wheel position and speed (from approx. 6 mph/10 km/h).

Motorway lighting

At higher speeds and continuous straight ahead travel, the dipped beam automatically raises slightly, thereby increasing headlight range.

► Adaptive driving lights * – see page 147.

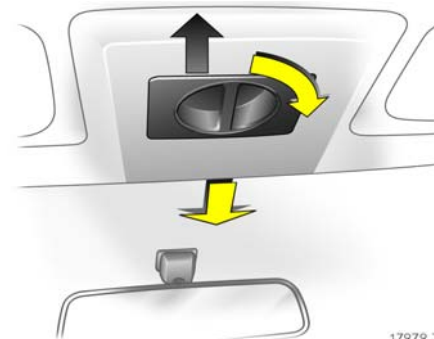

Panoramic windscreen *

To open:

Turn the handle to the right and move the roof lining rearward to a suitable position.

To close:

Move the roof lining forward to a suitable position. When moved all the way forward, the roof lining engages in position.

► Panoramic roof * – see page 53.



17203 T

Parking distance sensor *

When reverse gear is selected, the parking distance sensor switches itself on automatically.

The parking distance sensor can also be activated at speeds of less than 15 mph (25 km/h) by pressing the **P** button on the instrument panel.

If the vehicle approaches an obstacle when reversing, a series of signals can be heard in the vehicle interior. The interval between the signals becomes shorter as the distance is reduced. If the distance is less than 30 cm, the signal will be continuous.

► Parking distance sensor * – see page 215.

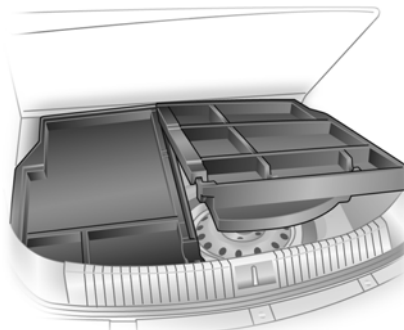

17092 T

Cargo box *

Collapsible box to divide the luggage compartment.

The cargo box may only be loaded when the backrests are engaged in an upright position.

When removing, start with the right half.

► Cargo Box * – see page 81.

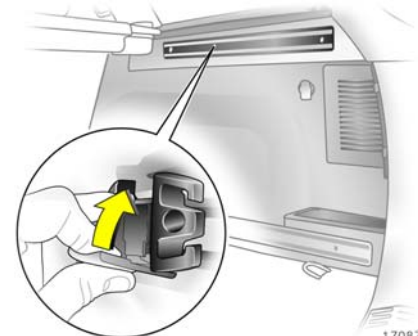

17087 T

FlexOrganizer *

The side walls contain retaining strips, where various components can be attached to divide the luggage compartment or fasten loads.

The system consists of

- Adapters
- Variable partition net
- Mesh pockets for the side walls
- Hooks in the luggage compartment

► FlexOrganizer * – see page 80.

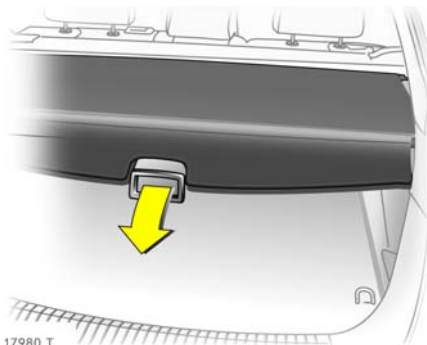

Luggage compartment cover, Estate

To open:

Press handle on luggage compartment cover down. The cover automatically unrolls.

► Luggage compartment cover ✱ – see page 76.

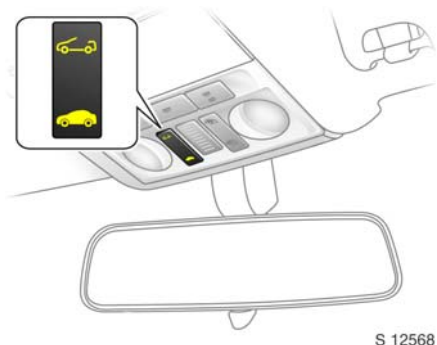

Astra TwinTop

With TwinTop, a convertible hardtop, Astra unites the benefits of a coupe with those of a convertible.

To optimise safety, the Astra TwinTop is equipped with a rollover protection system with reinforced windscreen frame and the choice of fixed or deployable anti-roll bars in addition to the front and side airbag systems.

The roof is operated with the buttons on the roof console above the mirror or with the remote control.

To improve luggage compartment accessibility, the electric loading aid makes it possible to raise the open roof when it is stowed in the luggage compartment.

► TwinTop – see page 56.

Diesel particle filter *

The diesel particle filter system removes polluting soot particles out of the engine exhaust gases. The system includes a self-cleaning function that operates automatically while driving. The filter is cleaned by burning the trapped soot particles at a high temperature. There may be an increase in fuel consumption, exhaust smell, and engine cooling fan operation * during the self-cleaning operation.

The self-cleaning function cannot operate automatically during certain driving situations where the engine does not reach its normal operating temperature. An example of this would be short distance driving in cold weather.



If the filter needs cleaning and recent driving situations did not allow the function to automatically operate, then the control indicator  will flash. If this occurs, then you may continue to drive the vehicle normally. The vehicle will not be damaged and does not require service.

The self-cleaning function will automatically operate while driving after the engine has reached its normal operating temperature. The control indicator  will continue to flash until the self-cleaning operation is complete. This may take up to 20 minutes of driving. The time will be shorter at higher vehicle speeds.

► diesel particle filter – page 207.

Keys, doors, windows, TwinTop

Replacement keys	30
Car Pass.....	30
outboardKey with foldaway key section *.....	30
Electronic immobiliser.....	31
Store personal vehicle settings in the vehicle key *.....	32
Remote control * with mechanical key.....	32
Open&Start system *.....	34
Central locking system	40
Fault when locking or unlocking.....	43
Luggage compartment.....	44
Vauxhall alarm system *.....	46
Child safety locks *.....	49
Exterior mirrors.....	49
Interior mirror	51
Electric windows *.....	51
Panoramic windscreen *.....	53
Sunroof *.....	54
TwinTop.....	56

Replacement keys

The key number is specified in the vehicle documents and in the Car Pass *.

The key is a constituent of the electronic immobiliser. Ordering keys from a Vauxhall Authorised repairer guarantees problem-free operation of the electronic immobiliser.

When electronic keys of the Open&Start system are being replaced, all keys must be handed to the dealer for programming.

Keep the spare key in a safe spot.

Locks – see page 291,
Open&Start system, electronic keys – see page 34.

Car Pass

The Car Pass contains all of the vehicle’s data and should therefore not be kept in the vehicle.

Have your Car Pass on hand when consulting a Vauxhall Authorised repairer.

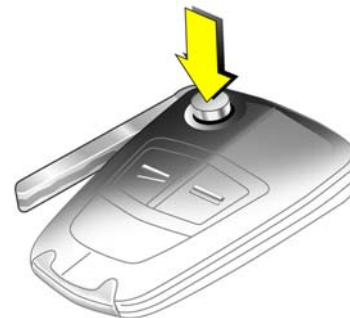

17027 T

outboardKey with foldaway key section *

Press button to extend. Press button to retract; key section engages audibly.

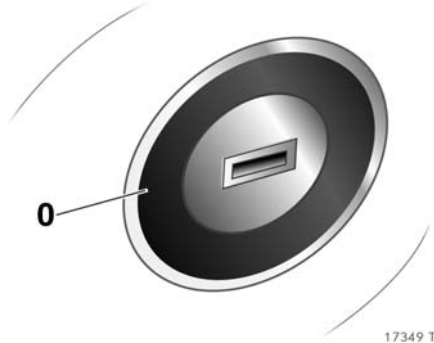

Electronic immobiliser

The system checks whether the vehicle may be started with the mechanical key or electronic key of the Open&Start system * that is being used. If the key is recognised as "authorised" the vehicle can be started. The check takes place via a transponder in the key.

The electronic immobiliser activates itself automatically after the key has been removed from the ignition or, with the Open&Start system *, when the engine is switched off by pressing the Start/Stop button.

The code number of the electronic immobiliser is given in the Car Pass.

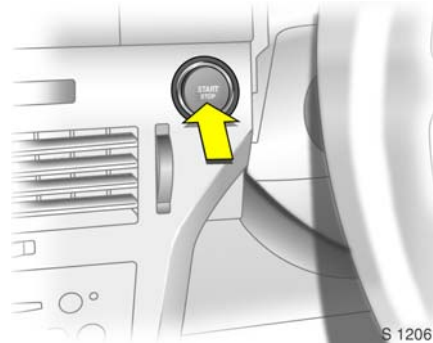

Control indicator for immobiliser

Control indicator  illuminates briefly when the ignition is switched on.

If the control indicator flashes when the ignition is on, there is a fault in the system; the engine cannot be started. Switch off the ignition and then repeat the start attempt.

If the control indicator  continues to flash, try to start the engine using the second key and contact a workshop for assistance.



If control indicator  illuminates after the engine is started, there is a fault in the engine electronics or transmission electronics * (see pages 182, 188, 196, 206) or there is water in the diesel fuel filter * (see page 300).

Note

The immobiliser does not lock the doors. Therefore, after leaving the vehicle always lock it and switch on the Vauxhall alarm system * – see pages 40, 46.

Store personal vehicle settings in the vehicle key *

The last settings selected

- instrument illumination,
- information display *,
- Infotainment system *,
- for the climate control system *

are stored automatically depending on the vehicle key used.

Different settings stored for each vehicle key are retrieved automatically on use of the vehicle key concerned.

Each time the vehicle is locked, the settings are saved again.

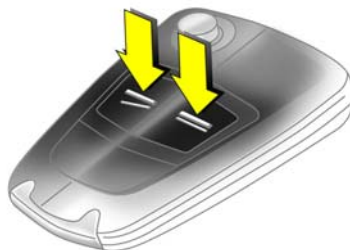

17029 T

Remote control * with mechanical key

Depending on vehicle equipment level, one of the remote controls shown on this page will be used.

Remote control in version with Open&Start system * – see page 34.

The remote control is integrated in the key.

Used to operate:

- central locking system,
- mechanical anti-theft locking system *,
- Vauxhall alarm system *.

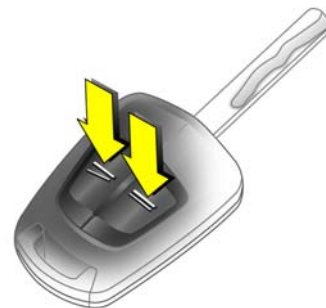

17030 T

On the Astra TwinTop, the roof can be opened or closed using the remote control *.

The remote control has a range of approx. 5 metres. This range can be affected by outside influences. Aim the remote control at the vehicle to operate.

Handle the remote control with care, protect it from moisture and high temperatures and avoid unnecessary operation.

The hazard warning lights come on to indicate that the remote control is operational.

Central locking system,
see page 40.

Mechanical anti-theft locking system ✱,
see page 41.

Vauxhall alarm system ✱,
see page 46.

Electric windows ✱,
see page 51.

Astra TwinTop,
see page 56.

Fault

If the central locking system cannot be operated with the remote control, it may be due to the following:

- The range of the remote control has been exceeded.
- Remote control battery voltage is too low. Battery replacement – see next page.
- Frequent, repeated operation of the remote control outside the reception range of the vehicle (e.g. too far from vehicle, remote control is then no longer recognised). Remote control synchronisation – see next column.

- If the central locking system is overloaded as a result of repeated operation at short intervals. The power supply is cut off for a brief period.

- Interference from higher-power radio waves from other sources.

To eliminate the cause of a fault, we recommend contacting a workshop for assistance.

Open driver's door with key – see page 43.

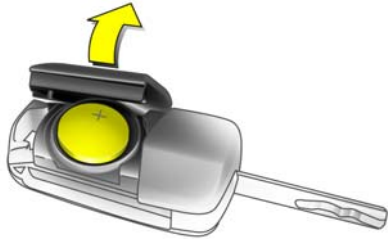

17031 T

Remote control battery replacement

Replace the battery as soon as the range of the remote control begins to shrink.

Key with foldaway key section

Fold out key bit, see page 30.

Open remote control. Replace battery, battery type, see page 345, paying attention to installation position. Close remote control.

Make sure that you dispose of old batteries in accordance with environmental protection regulations.

Key with fixed key section

Have the battery changed by a workshop.

Remote control synchronisation

After replacing the battery, unlock door with key in lock, see page 43. The remote control is synchronised by switching the ignition on.



S 12071

Open&Start system *

The Open&Start system allows the vehicle to be locked and unlocked, including operation of the anti-theft locking system * and the Vauxhall alarm system *, and also allows the engine to be switched on and off without a mechanical key. All the driver has to do is carry the electronic key around with him.

On the Astra TwinTop, the roof can also be opened or closed with the remote control * of the electronic key.

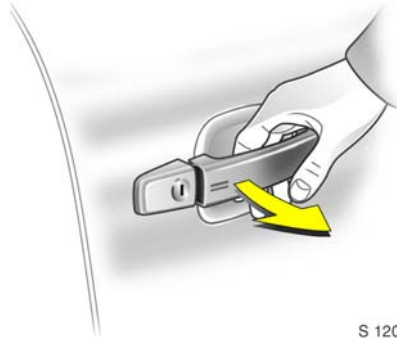

S 12076

The electronic key must be within the external reception range about 1 metre from the vehicle in order to lock and unlock the vehicle.

If the electronic key is recognized as "authorised", the vehicle can be unlocked by pulling a door handle or the knob beneath the tailgate handle and the doors and the tailgate can be opened.

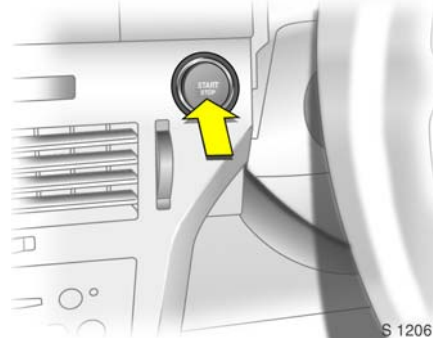

S 12061

When the Start/Stop button is pressed, the system re-checks the authorisation. The electronic key has to be recognised in the interior in order to do this. After the key has been authorised the ignition switches on. At the same time, the electronic immobiliser is switched off and the electro-mechanical steering column lock is deactivated. Pressing the Start/Stop button again with the brake or clutch pedal depressed or in **P** or **N** with automatic transmission * starts the engine. Press the button for at least one second with the vehicle stationary or hold until the engine starts.

If the brake or clutch pedal is depressed, the engine can be started right away with a single press on the Start/Stop button.

Releasing the Start/Stop button interrupts the starting procedure.

The engine and the ignition are switched off by pressing the Start/Stop button again. The vehicle must be stationary. The immobiliser is activated at the same time.

If the ignition has been switched off and the vehicle is stationary, the steering wheel lock activates automatically when the driver's door is opened or closed.

The electronic key must be within the interior reception in order to switch the ignition on or off. We recommend that the driver carries the electronic key on his or her person. If the electronic key is not recognised, try a different position for the key.

Do not put the electronic key in the luggage compartment or in front of the information display.



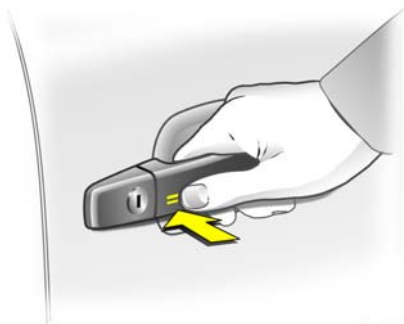

S 11527

The vehicle is locked from the outside with the doors closed by touching the sensor panel in the door handle of one of the front doors. The electronic key must be within the external reception range of approximately one metre from the vehicle.

The Open&Start system * does not lock the vehicle automatically if the electronic key is outside the external reception range of approximately 1 metre from the vehicle.

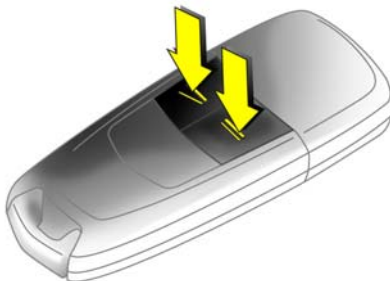

17035 T

Remote control

The vehicle can be locked and unlocked by in the usual way using the remote control with the buttons on the electronic key.

In addition, the anti-theft locking system and Vauxhall alarm system can be armed and disabled using the remote control.

The remote control has a range of approx. 5 metres. This range can be affected by outside influences. Aim the remote control at the vehicle to operate.

Handle the remote control with care, protect it from moisture and high temperatures and avoid unnecessary operation.

The hazard warning lights come on to indicate that the remote control is operational.

Central locking system,
see page 40.

Mechanical anti-theft locking system *,
see page 41.

Vauxhall alarm system *,
see page 46.

Electric windows *,
see page 51.

Astra TwinTop,
see page 56.



17036 T

Control indicator for Open&Start system

If the control indicator flashes  with the ignition switched on or with the engine running an operating error has occurred, e.g. the electronic key is no longer within the reception range of the vehicle interior. During the next starting procedure the engine may not be able to be started. Press Start/Stop key slightly longer to switch the ignition off.

Flashing of the  can also be an indication of complete failure of the electronic key. In this case operation is only possible using the emergency facility, see page 37.

InSP3 in the service display or an appropriate message in the information * display indicates that the battery of the electronic key needs replacing, see page 39.

If the control indicator  illuminates continuously, an error has occurred in the system. Lock or unlock vehicle using the remote control or the emergency key if necessary, see page 43, or try using the spare key.

If  illuminates, this can also mean that the steering column lock is still locked: move steering wheel to and fro a little and press Start/Stop button again.

If  illuminates while driving, there is a system fault. Contact a workshop immediately.

Emergency operation, see page 37.

Lockable glovebox, Astra TwinTop with Open&Start system *

In addition to the electronic key of the Open&Start system, there is a standard key without remote control for the glove compartment lock.

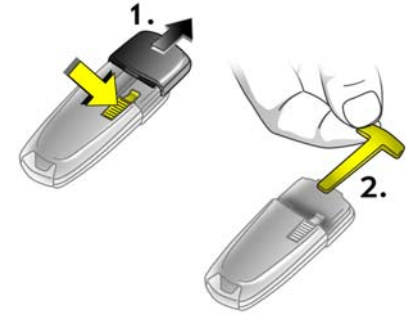

17037 T

Emergency operation

If the Open&Start system fails or the electronic key (control indicator ) flashes or illuminates continuously) the driver's door can be locked or unlocked with the emergency key in the electronic key: press locking mechanism on underside and remove cap toward the front by applying gentle pressure to the cap. Push emergency key towards the outside over the detent and remove.



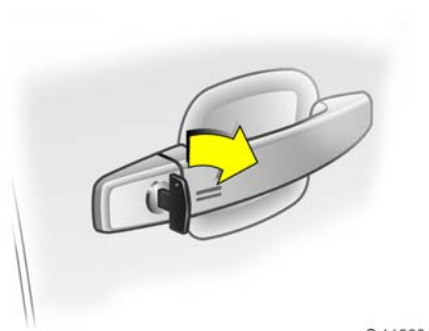

S 11528

Only the driver's door can be locked and unlocked using the emergency key. Unlock the entire vehicle as described on page 43. In the version with Vauxhall alarm system * the alarm may be triggered when the vehicle is unlocked. Switch ignition on to deactivate alarm and release the steering column lock: hold electronic key at marked position on the steering column panelling and press the Start/Stop button. Repeat procedure if necessary.

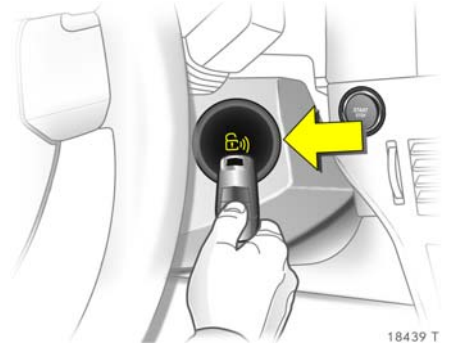

18439 T

To start the engine, hold electronic key in marked position, operate brake or clutch pedal or with automatic transmission * operate brake pedal and select **P** or **N**.

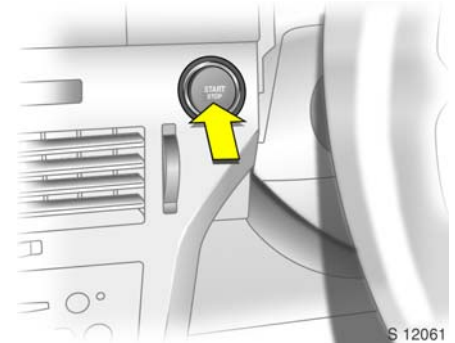

S 12061

The press start/stop button.

Press start/stop button for at least 1 second to switch the engine off. Lock all doors except driver's door as described on page 43. Unlock driver's door with emergency key.

This facility is for emergency use only. Replace the battery of the electronic key as soon as possible or have the system repaired. Contact a workshop for assistance.



17040 T

Replacing battery in electronic key

Replace the battery immediately if the system is no longer working properly or the range of the remote control is reducing. The need for a battery change is indicated via InSP3 in the service display or, in vehicles with check control , by an appropriate message in the display. See page 120.

To replace the battery, operate lock on underside of electronic key and remove cover by pushing gently forwards, see Fig. 17037 T on page 37.



17041 T

Push off cover with emblem on side towards the outside using the buttons.

Replace battery, for battery type, see page 345, pay attention to installation position. Engage caps.

Remote control synchronisation

The remote control synchronises itself automatically during every starting procedure.

Fault in Open&Start system or remote control.

If the central locking cannot be operated or the engine cannot be started, the cause may be one of the following:

- Electronic key out of reception range, or out of range of remote control,

- Remote control battery voltage too low – refer to text in previous columns for instructions on how to change battery.
- Frequent, repeated operation of the remote control outside the reception range (e.g. too far from vehicle, remote control is then no longer recognised).
- If the central locking system is overloaded as a result of repeated operation at short intervals. The power supply is cut off for a brief period.
- Interference from higher-power radio waves from other sources.

To eliminate the fault, change the position of the electronic key or remote control or change the battery in the remote control. If the fault persists, contact a workshop for assistance.

Emergency operation, see page 37.

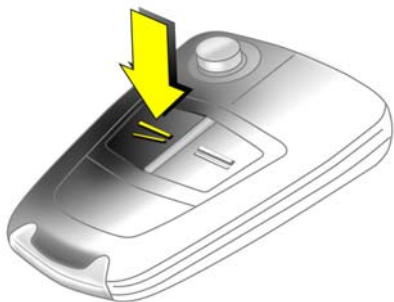

16968 T

Central locking system

For doors, boot lid/tailgate and tank flap.

To unlock

Remote control with mechanical key

Press button  on remote control.

To open the door, pull the handle. Open the luggage compartment by pulling the knob under the tailgate handle.

If the door or the luggage compartment is open,  illuminates in the instrument panel.

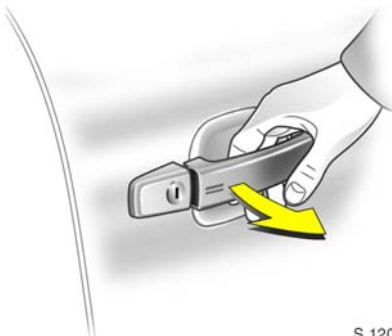



S 12076

Open&Start system with electronic key *

The electronic key must be within the outside reception range of the vehicle. Unlock the vehicle by pulling a door handle or the knob below the tailgate handle.

– or –

Press button  of the electronic key's remote control.

If the door or the luggage compartment is open,  illuminates in the instrument panel.

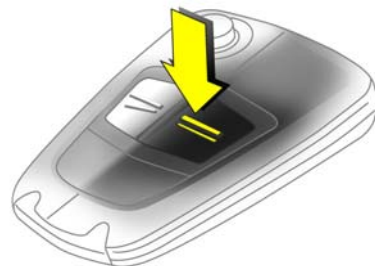

17042 T

To lock

Close doors, luggage compartment and tank flap.

Remote control with mechanical key

Press button  on remote control.

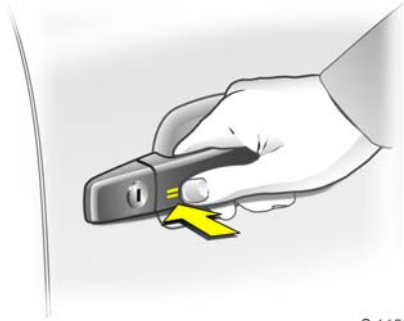

S 11527

Open&Start system with electronic key *

The electronic key must be within the outside reception range of the vehicle. There must be no electronic keys inside the vehicle. Touching the sensor in the door handle of the driver's or front passenger's door locks all doors and the luggage compartment.

– or –

Press button  of the electronic key's remote control again.

Mechanical anti-theft locking system *

Warning

Do not use the system if there are people in the vehicle! The doors cannot be unlocked from inside.

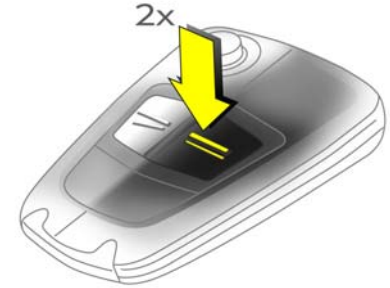

17043 T

Remote control with mechanical key

All doors must be closed. At the latest 15 seconds after locking, press button  on the remote control again.

Lock buttons on all doors are positioned such that doors cannot be opened.

If the ignition was on, the driver's door must be opened and closed once so that the vehicle can be secured.

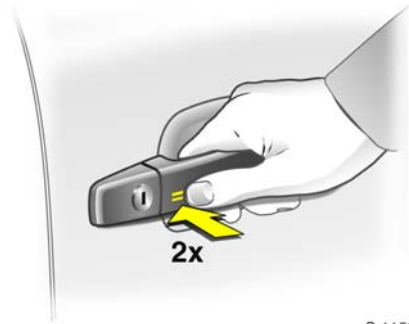

S 11530

Open&Start system with electronic key *

All doors must be closed. The electronic key must be within the outside reception range of the vehicle. Touch the sensor in the door handle of the driver's or front passenger's door again within 15 seconds after locking.

– or –

Press button  of the electronic key's remote control again.

All doors are secured against opening.

If the ignition was on, the driver's door must be opened and closed once so that the vehicle can be secured.

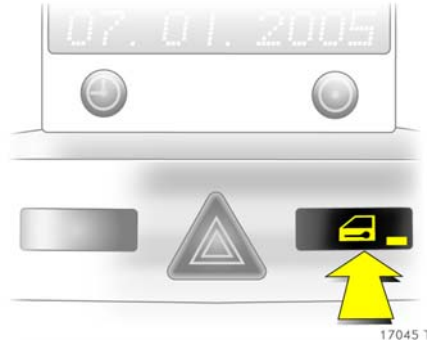

17045 T

Central locking button for locking and unlocking the doors from inside the vehicle

Press button  in the centre console: doors are locked or unlocked.





The LED in the central locking button  illuminates for around 2 minutes after locking with the remote control.

If the doors are locked from the inside during the journey using the central locking button, the LED  illuminates continuously.

If the key is in the ignition, locking is only possible if all doors are closed.

When the mechanical anti-theft locking system * is active – see previous page – the doors cannot be unlocked with this button.

Note

- The central locking system will not lock if the driver's door is not properly closed.  illuminates in the instrument panel as an indication.
- If the front passenger door, the rear doors * or the luggage compartment is not correctly closed, the LED in the central locking button  flashes for 10 seconds when the central locking system is operated, and  illuminates in the instrument panel at the same time.
- To lock the doors from within (e.g. to prevent unwanted entry from outside), press central locking switch  in the centre console.
- When the vehicle is unlocked with the key in the driver's door lock, the other doors do not unlock until the driver's door is opened.
- Doors that have been locked using the central locking system can also be opened by pulling the handle on the inside of the doors. The central locking is also unlocked at the same time (not possible with Astra TwinTop if roof is open).
- Locked doors unlock automatically in the event of an accident of a certain severity (to allow external help to gain access). The hazard warning lights and courtesy light also come on. For this to occur, the key must be in the ignition switch.

- With the Open&Start system * the vehicle cannot be unlocked until 2 seconds after locking. Within this time, a door handle can be pulled or the button beneath the tailgate handle operated to check whether the vehicle is locked.
- The Open&Start system * does not lock the vehicle automatically if the electronic key is outside the reception range of the vehicle (more than 1 metre away from the vehicle).
- When using the Open&Start system *, there must not be an electronic key inside the vehicle when locking.
- The locking sensors in the door handles must be kept clean to ensure unrestricted functionality of the Open&Start system *.

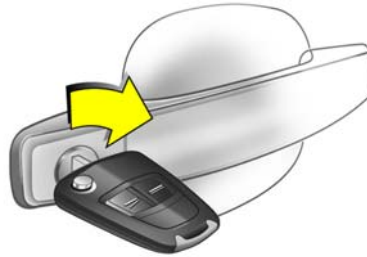

S 11532

Fault when locking or unlocking

Fault in remote control or Open&Start system. *

To unlock

Turn key or emergency key for Open&Start system * (see page 37) forwards in the driver's door lock as far as it will go. Return key to a vertical position and remove. The entire vehicle is unlocked when the driver's door is opened.

For Astra TwinTop with open roof - after opening the driver's door, press the central locking button  in the centre console. The vehicle will then be unlocked, provided the anti-theft locking system * is not engaged. Switch on the ignition to deactivate the Vauxhall alarm system *. Emergency operation of the Open&Start system *, see page 37.

To lock

Open passenger door, close driver's door, press central locking button  in centre console. Central locking system locks all doors. Close passenger door.

Malfunction in central locking system

To unlock

Turn key or emergency key with Open&Start system *, see page 37, forwards in driver's door lock as far as it will go. Turn key back to a vertical position and remove. The other doors can be opened by pulling the handle on the inside of the doors (not possible if anti-theft locking system * enabled beforehand). The luggage compartment and the fuel filler cap remain locked. To deactivate the anti-theft locking system * switch ignition on, see page 46.



To lock

Insert the key or emergency key for Open&Start system * (see page 37) into the opening above the lock on the inside of the door and press until the lock audibly engages. Then close the door. The procedure must be repeated for each door. The driver's door can also be locked from outside using the lock. The unlocked fuel filler flap and tailgate/boot lid cannot be locked.

Emergency operation of Open&Start system *, see page 37.

Luggage compartment

To unlock

Remote control with mechanical key
Press button  on the remote control. The luggage compartment is unlocked together with the doors.

Open&Start system with electronic key *
Pulling the button below the handle unlocks and opens the luggage compartment and doors when the electronic key is detected within the outer reception range.

– or –
Press button  on the remote control of the electronic key, this unlocks the luggage compartment and the doors.

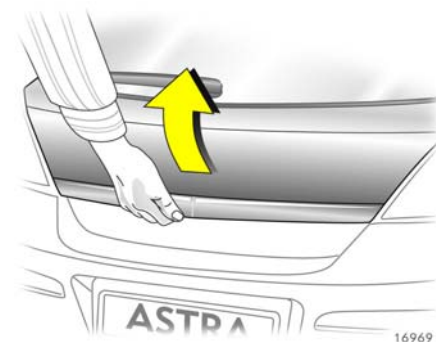

To open:

The luggage compartment is opened by operating the button beneath the handle.

 Warning
<p>Do not drive with the tailgate open or ajar, e.g. when transporting bulky objects, since toxic exhaust gas could penetrate the interior.</p>

Fitting of accessories on the tailgate will increase its weight. If it becomes too heavy, the tailgate will then not stay open.

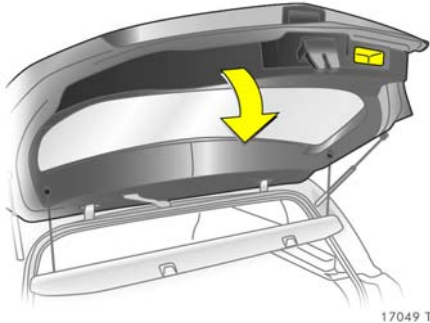

17049 T

To close:

Close luggage compartment using the handle on the inside of the tailgate.

Do not operate the button beneath the handle when closing. Otherwise the luggage compartment will once again be unlocked.

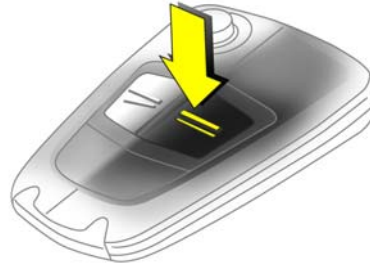

17042 T

To lock

Close doors, luggage compartment and tank flap.

Remote control with mechanical key

Press button  on remote control.

Open&Start system with electronic key *

Press button  of the electronic key remote control or touch sensor in handle of one of the front doors. The electronic key must be recognised in the external reception area. It is advisable for the driver to keep the electronic key on his person.

Vauxhall alarm system *

monitors

- the doors, luggage compartment, bonnet,
- the passenger compartment,
- vehicle tilt, e.g. if it is raised,
- the ignition.

Warning

Do not use the system if there are people in the vehicle! The doors cannot be unlocked from the inside.

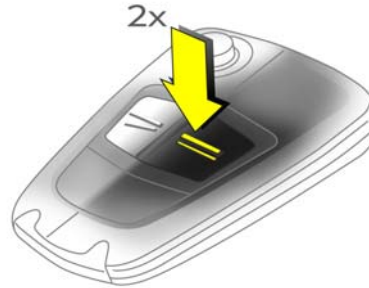

17043 T

To activate

Remote control with mechanical key

All doors, windows, the sun roof * and the bonnet must be closed. Within 15 seconds of locking, press button = on the remote control again.

If the ignition was switched on, the driver's door must be opened and closed once so that the Vauxhall alarm system can be switched on.

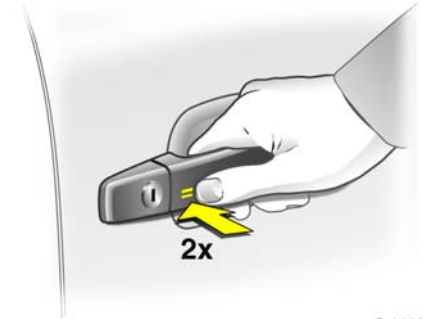

S 11530

Open&Start system with electronic key *

All doors, windows and bonnet must be closed. The electronic key must be in the outer reception range of the vehicle. No more than 15 seconds after locking, touch the sensor in the handle of the driver's or front passenger door again.

– or –
Press button = of the electronic key's remote control again.

If the ignition was switched on, the driver's door must be opened and closed once so that the Vauxhall alarm system can be switched on.

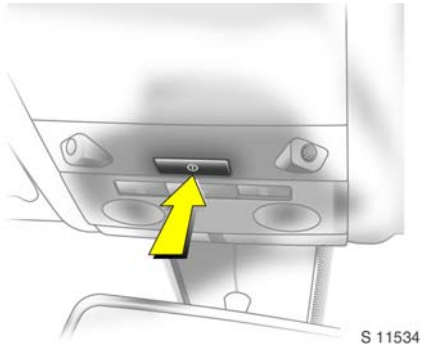

Activation without monitoring of passenger compartment and vehicle tilt

To activate e.g. if animals are left in the vehicle.

1. Close tailgate and bonnet.
2. Press button ① in the roof console.
The LED in button ① flashes (max. 10 seconds), see Fig. 17051 T.
3. Close doors.

4. Switch on Vauxhall alarm system. LED illuminates. After approx. 10 seconds the system is activated, without monitoring of the passenger compartment or vehicle tilt. LED flashes until system is switched off.

For Astra TwinTop, passenger compartment monitoring is deactivated if the roof is open to prevent false alarms.



Light emitting diode (LED)

During the first 10 seconds of Vauxhall alarm system activation:

- LED on = Test, activation delay
- LED flashes quickly = Door, luggage compartment or bonnet open, or system fault

After the first 10 seconds of Vauxhall alarm system activation:

- LED flashes slowly = System activated
- LED on after approx. 1 second = Deactivation function

If a system fault occurs, contact a workshop.

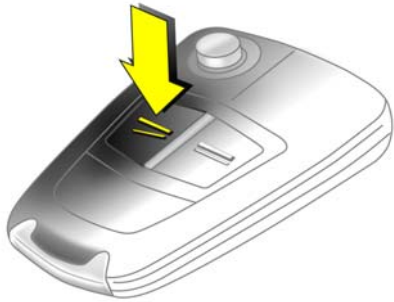

16968 T

To deactivate

Remote control with mechanical key

Press button  on remote control

– or –

Switch on ignition.

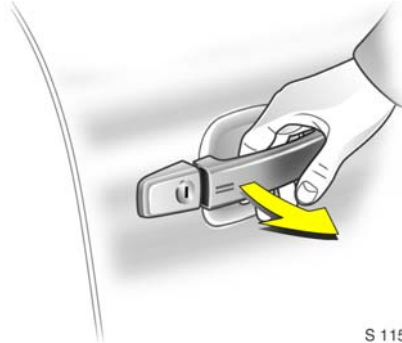

S 11526

Open&Start system with electronic key ✳

Pulling a handle or the button below the tailgate handle unlocks the vehicle and disables the Vauxhall alarm system when the electronic key is detected within the outer reception range.

– or –

Press button  of the electronic key's remote control.

In the event of a fault in the remote control or the Open&Start system, open the vehicle as described on page 43.

If the alarm is triggered when the driver's door is opened, deactivate the Vauxhall alarm system by switching on the ignition.

Note

Changes to the vehicle interior, such as the use of seat covers, could impair the function of passenger compartment monitoring.

Alarm

While the Vauxhall alarm system is switched on the alarm can be triggered:

- an acoustic signal (horn) and
- a visual signal (hazard warning lights).

The number and duration of the alarms are legally established.

The alarm can be silenced by pressing a button of the remote control or by switching on the ignition. The Vauxhall alarm system is deactivated at the same time.



17052 T

Child safety locks *

Warning

Use the child safety lock whenever children are occupying the rear seats. Disregard may lead to injuries or endanger life. Vehicle passengers should be informed accordingly.

Using key or screwdriver, turn knob on rear door lock from the vertical position: door cannot be opened from inside.



S 12058

Exterior mirrors

Manual adjustment with levers in the front doors or electric * switch in driver's door console.

Adjust exterior mirrors manually

Swivel lever in mirror base on front doors.

The mirror glass swivels in the same direction as the activation of the lever.

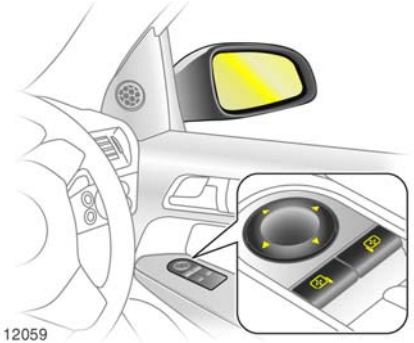

S 12059

Adjust exterior mirrors electrically *

Adjust with the four-way switch in driver's door: press mirror switch to left or right: four-way switch works on corresponding mirror.

The mirror glass swivels in the same direction as the activation of the four-way switch.

Aspherical exterior mirror *

The aspherical mirror glass reduces the blind spot. The curvature makes objects appear smaller, so it is more difficult to estimate the distance from following vehicles.

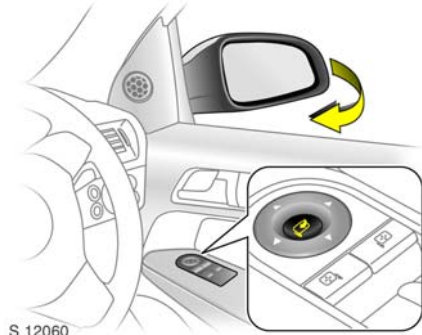



S 12060

Swing in exterior mirror:

Manual: The exterior mirrors can be swung in by pressing on the outside of the housing.

Electrically ✱: Press  and both mirrors will swing in.

Press button  again - both exterior mirrors swivel to the driving position.

If an electrical retracted mirror is extended manually, pressing button  will cause the mirror to move all the way forward. The other mirror will be electrically swiveled to the driving position. If button  is pressed again, both mirrors will be electrically retracted. Press again: both mirrors swivel to the driving position.

Fold mirrors back into driving position before moving away.

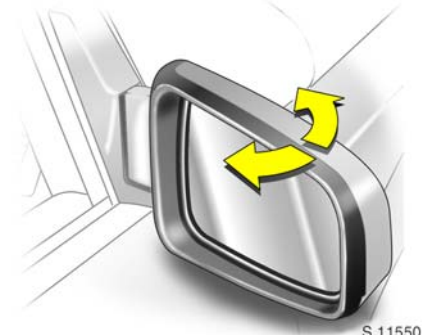

S 11550

For the safety of pedestrians, the exterior mirrors will swing out of their normal mounting position if they are bumped with sufficient force. Reposition the mirror by applying slight pressure to the mirror housing.

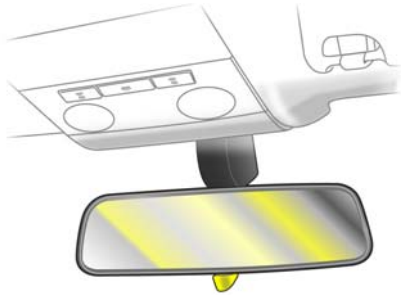

S 11514

Interior mirror

To adjust, swivel mirror housing.

To reduce dazzling at night, swivel lever on underside of mirror housing.



S 11551

Automatic anti-dazzle interior mirror*

Dazzling is automatically reduced at night.

With the ignition off, the mirror does not dim.

Electric windows*

Warning

Take care when operating the electric windows* and the sun roof*. Risk of injury, particularly to children. Vehicle passengers should be informed accordingly.

If there are children on the rear seat, switch on the child safety system* for the electric windows.

Keep a close watch on the windows and sun roof when closing them. Ensure that nothing becomes trapped in them as they move.

The electric windows can be used

- with ignition on,
- within 5 minutes of switching ignition off*,
- within 5 minutes of switching ignition key to position 1.

Stand-by after switching on the ignition ends when the driver's door is opened.

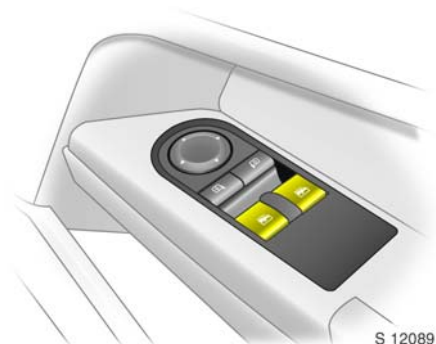

Operated via two or four ✱ switches in the driver's door handle. The front switches are for the driver and front passenger doors. The rear switches ✱ are for the rear doors. Additional switches are located in the front passenger door and rear doors ✱.

For incremental operation, briefly pull or press the switch. For automatic opening or closing, pull or press the switch longer. Pull or press the switch again to stop the movement.

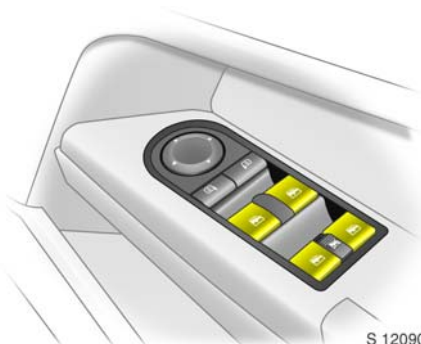

Safety function

If the window glass encounters resistance above the middle of the window during automatic closing, it is immediately stopped and the window opened again.

In the event of difficulty due to frost or the like, press the appropriate window switch several times until the window is closed.

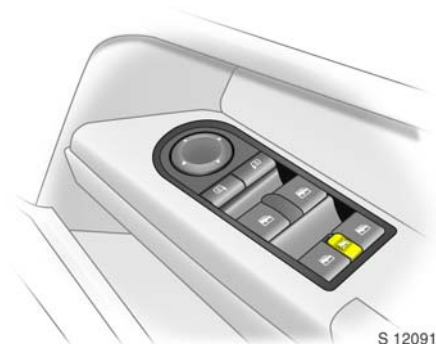



Child safety system for rear windows ✱

Switch ✱ between the rear switches in the driver's door handle

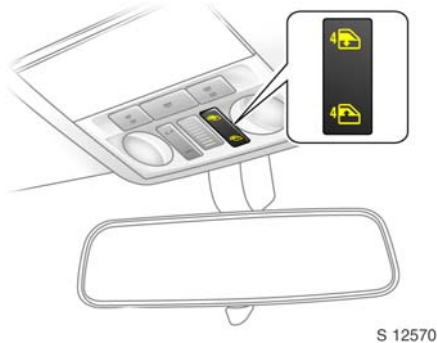
- Forward (red field visible): Rear door switches non-operational
- Rearward (green field visible): Rear door switches operational



**Central switch for electric windows,
Astra TwinTop**

Button  or  in the roof console.

Press button : all windows are closed.

Press button : all windows are opened.

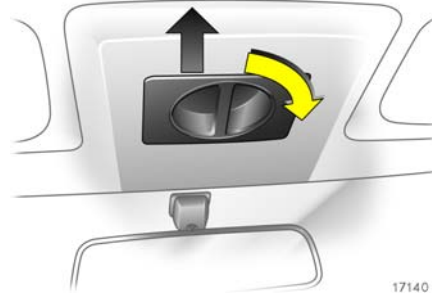

Panoramic windscreen *

Open the roof lining

Turn the handle to the right and move the roof lining rearward to a suitable position.

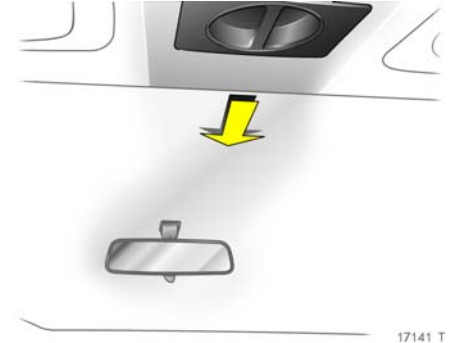

Close the roof lining

Move the roof lining forward to a suitable position. When moved all the way forward, the roof lining engages in position.

Note

Close the sun visors before sliding the roof lining.

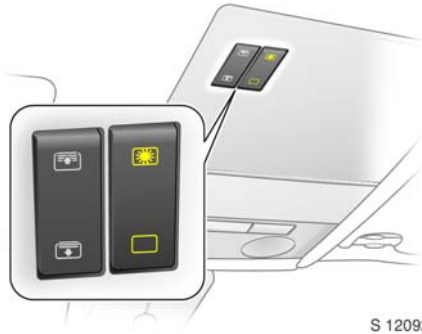

S 12092

Sunroof *

Operated via rocker switches in the roof console when the ignition is switched on.

For incremental operation, briefly press the button. For automatic opening or closing, press the button longer.

To raise:

When the roof is closed, press button ☀️. The roof is tilted in the rear.

To open:

Press button ☀️ again from the tilted position. The roof opens to its stop.

To close:

Press button ◻️.

For reasons of safety, the roof closes from its open position to approx. 20 cm. Hold button ◻️ depressed to close completely.



17139 T

Sunblind

Used to reduce sun penetration into the interior when the sunroof is closed.

The sunblind opens when the sun roof opens.

To open:

Press button ☀️. The sunblind opens to its stop.

To close:

Press button ◻️.

For reasons of safety, the roller blind closes from its open position to approx. 20 cm. Hold button ◻️ depressed to close completely.

Note

- If the top of the roof is wet, raise roof, allow water to run off and then open roof.
- When using a roof rack, check the clearance of the sun roof to avoid damage.

Overload

If the system is overloaded, the power supply is automatically cut off for a short time.

The system is protected by fuses in the fuse box, see page 262.

Fault

If the sun roof and sunblind do not operate properly, activate electronics as follows:

1. Switch on ignition.
2. Close the sun roof and hold button depressed at least 10 seconds.
3. Close sunblind and hold button  depressed at least 10 seconds.

TwinTop

With TwinTop, a convertible hardtop, Astra unites the benefits of a coupe with those of a convertible.

Warning

Take care when operating the convertible hardtop. Risk of injury.

Monitor the action zone above, to the side and to the rear of the vehicle during roof operation. Make sure that nothing could become pinched.

Make sure no one is in the action zone of the roof or boot lid during roof operation. Risk of injury.

Check the amount height, length and width of available space before operating the roof, e. g. in a garage, parking garage or when a bicycle rack is fitted.

Vehicle passengers should be informed accordingly.

Before leaving the vehicle, remove the ignition key in order to prevent unauthorised operation of the windows and sunroof.

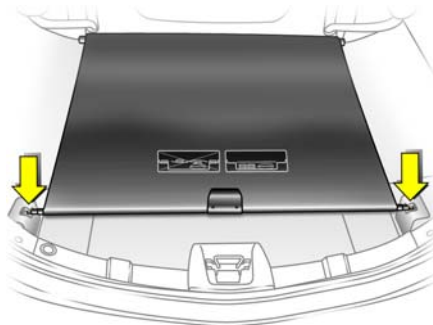

18024 T

Operating the convertible hardtop

Stand-by with ignition key in lock from position 1, or for Open&Start-System * switch on ignition.

Requirements:

- Vehicle is stationary or driving no more than 20 mph (30 km/h).
- Luggage compartment blind is closed and engaged - see Fig. 18024 T above and page 82.
- Boot lid is closed.

If any of the requirements are not fulfilled, a warning buzzer sounds when the switch is actuated and the roof does not open or close.

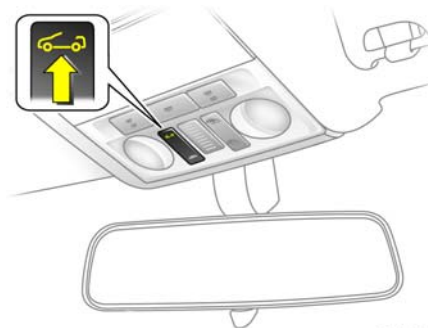

S 12571

To open the roof

There must be no objects in front of the rear window or in the pivot area of the roof and boot lid.

Hold button  in the roof console depressed until the roof is completely open and the boot lid is closed.

An acoustic signal sounds at the end of the opening procedure.

Open the door windows slightly before opening the roof. If button  is pressed again after the acoustic signal sounds, the door windows will close.

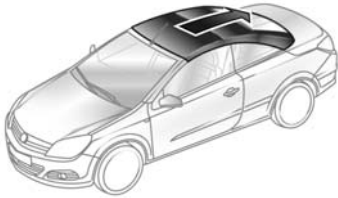

17970 T

With the vehicle stopped, the roof can be opened using the remote control . Unlock the vehicle. Press button again and keep pressed until the roof has opened fully and the boot lid has closed.

During operation with the remote control, the door windows are opened completely.

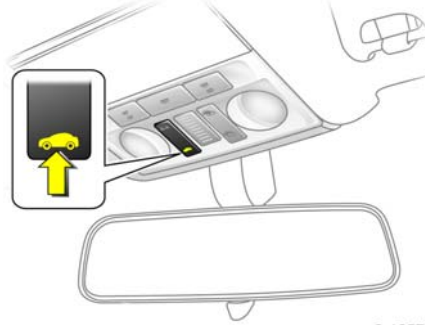

S 12572

To close the roof

There must be no objects in the pivot area of the roof and boot lid.

Hold button in the roof console depressed until the roof and boot lid are completely closed.

An acoustic signal sounds at the end of the closing procedure.

Open the door windows slightly before closing the roof. If button is pressed again after the acoustic signal sounds, the door windows will close.



17971 T

With the vehicle stopped, the roof can be closed using the remote control . Lock the vehicle. Press button again and keep pressed until the roof and boot lid have closed completely.



Indicator and warning buzzers

- Indicator buzzer upon completed opening or closing of the convertible hardtop.
- Indicator buzzer upon completed raising or lowering of the electric luggage compartment loading aid.
- Gong tone if the boot lid is not closed during roof operation.
- Gong tone if the boot lid is not fully opening during operation of the luggage compartment loading aid.
- Gong tone during roof operation if vehicle speed exceeds 20 mph (30 km/h).
- Gong tone when vehicle speed exceeds 20 mph (30 km/h) if the roof is not fully open or closed.
- Three gong tones during roof or loading aid operation if the luggage compartment blind is not attached.
- Three gong tones during roof operation if outside temperature is below -20 °C, vehicle battery voltage is too low or the system is overloaded.

- Continuous warning buzzer during roof operation if the anti-roll bars * have been triggered.
- Continuous warning buzzer starting one minute before the end of the 9-minute stand-by time with the roof in an intermediate position.
- Continuous warning buzzer starting one minute before the end of the 9-minute stand-by time with the loading aid in a raised position.
- Continuous warning buzzer when closing the boot lid if the lowering process of the electric load aid is not complete or was interrupted.

Note

- Do not open the luggage compartment until the acoustic signal indicating the end of the roof opening or closing procedure has sounded.
- The luggage compartment blind must always be closed during roof operation.
- There must be no one at the covers behind the rear head restraints.
- There must be no objects in the pivot area or the roof or on the covers behind the rear head restraints.
- The roof can only be operated at temperatures above -20 °C. If the temperature is below this limit, a gong will sound three times when roof operation is requested.
- Frequent operation of the roof with the engine off discharges the battery.
- Repeated operation of the roof without breaks can cause overloading and therefore malfunctions.

- The roof can be held in an intermediate position for 9 minutes to facilitate cleaning of roof spaces. This is done by disengaging the actuation switch. One minute before the end of this period, a continuous buzzer sounds as a warning that the hold period is almost over and the roof could start to move.
- Activating the roof on uneven ground can lead to malfunctions and damage.

Fault

The automatic drive of the roof is only operational if the roof is in the proper open or closed position.

Check if:

- The luggage compartment blind is engaged in the closed position
- The boot lid is completely closed
- Outside temperature is above -20°C
- There is sufficient battery voltage
- There is a system overload

If the automatic drive is not operational, two persons are required to manually close the roof. See the accompanying instructions for Astra TwinTop. We recommend that you seek professional assistance.

Rollover protection system

To optimise safety in the event of a rollover, the Astra TwinTop is equipped with reinforced windscreen frame and anti-roll bars behind the rear seat head restraints. The anti-roll bars are fixed or deployable depending on vehicle variant.

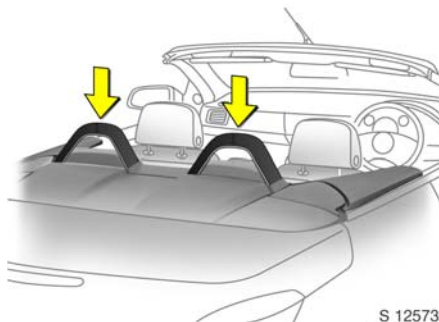

S 12573

Fixed anti-roll bars
are secured to the vehicle bodywork.

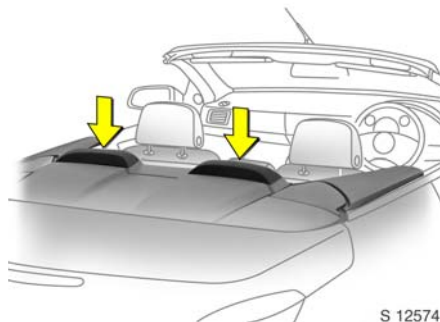

S 12574

Deployable anti-roll bars ☘
are located between the rear head restraints and the boot lid in such a way that they are out of sight. In the event of a rollover, head-on collision or side impact, the anti-roll bars deploy upwards within milliseconds. The convertible roof must not be operated if the anti-roll bars have been deployed. A continuous warning will sound if the switch is actuated. The airbag control indicator ☘ illuminates if the anti-roll bars have been deployed.

Manual retraction of the anti-roll bars – see page 104.

Further information, see page 106.

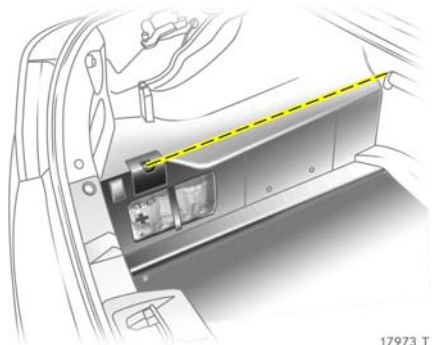

17973 T

Luggage compartment

The roof can only be opened if the load in the luggage compartment does not exceed the height of the luggage compartment blind or protrude sideways. The load height marked in the figure must not be exceeded. The luggage compartment blind must be flat; objects below it must not press it upwards. Otherwise the roof and load may be damaged.

Electrically operated loading aid for the luggage compartment – see page 82.

Luggage compartment blind – see page 82.

Blockage of boot lid on closure ❄

To avoid damage to the open roof, boot lid or load, the boot lid can only be closed if the electric load aid is in the lower end position, see page 82.

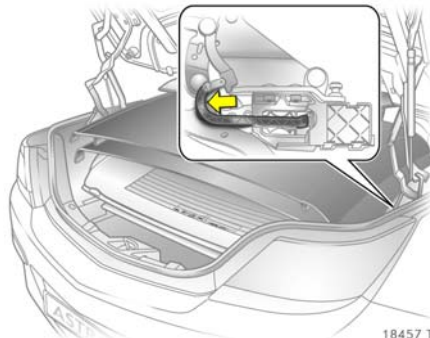
**Unblocking on failure of electric drive**

Push locking lever forward as shown in the figure.

Wind deflector ❄

With the wind deflector installed turbulence, draughts and noise in the passenger compartment are reduced when the roof is open.

The rear seats cannot be occupied when the wind deflector is in place.

Do not place any objects on the wind deflector.

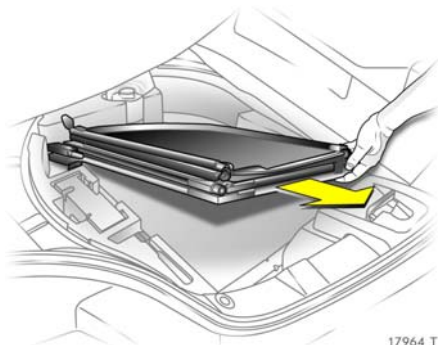

With tyre repair set ✱, the wind deflector is folded down into a storage compartment ✱ in the luggage compartment below the loading floor cover.

For the version with spare wheel ✱, the wind deflector is folded away in the luggage compartment

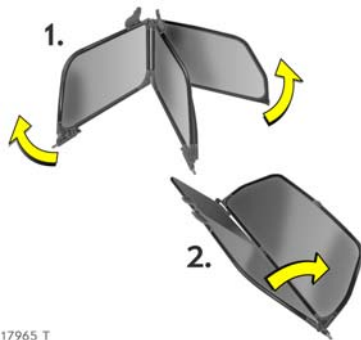

Fitting

Take the wind deflector from the luggage compartment.

Expand the collapsed wind deflector as illustrated.

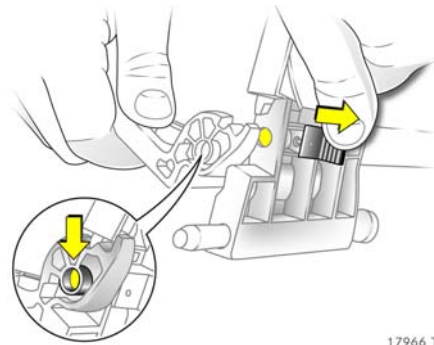

Join together the unfolded ends of the wind deflector: press in the pin at the slider, guide the hinge over the pin and release the slider so that the pin engages in the hinge.

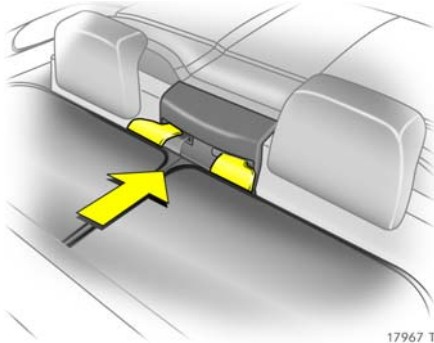

Insert the guide clips of the wind deflector in the seat belt recesses between the rear head restraints.

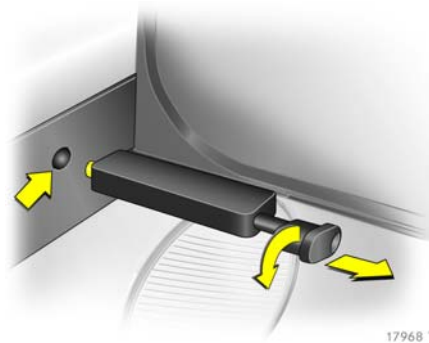

Pull the toggle of the right and left locking pin and turn to lock. Straighten out the wind deflector, turn the toggle back and engage the locking pin in the recess in the side trim.

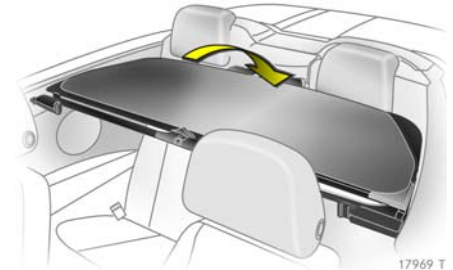

The wind deflector can be folded back when not in use.

If the wind deflector is folded and the rear seats are unoccupied, the wind deflector can remain mounted in the vehicle when the roof is closed.

Removing

Remove in reverse order, wind deflector is completely folded down in the luggage compartment:

- For tyre repair kit ✱ in the compartment below the loading floor cover.
- For version with spare wheel ✱, place in the luggage compartment.

The wind deflector must never protrude upwards or sideways from the luggage compartment, see marked loading height, see Fig. 17973 T on page 60.

Seats, interior

Front seats	64	Operating the seat belts.....	88
Head restraints	68	Child restraint system *.....	90
Armrest * at driver's seat.....	70	Vauxhall Full Size airbag system	92
Armrest * in back seat backrest.....	70	Rollover protection system *.....	104
Extending the luggage compartment, Hatch	71	Cigarette lighter *.....	107
Extending the luggage compartment, Estate	72	Accessory socket *.....	107
Extending the luggage compartment, Astra TwinTop.....	75	Ashtray *.....	108
Folding down the front passenger seat *.....	75	Foldaway tables *.....	110
Luggage compartment cover	76	Stowage compartments	110
Safety net *, Estate.....	78	Sun visors	111
Luggage compartment grille *, pick-up	79		
Lashing eyes *	80		
Rails and hooks in the luggage compartment *, Estate	80		
FlexOrganizer *.....	80		
Cargo box *.....	81		
Luggage compartment blind, Astra TwinTop.....	82		
Easy Load.....	82		
Notes on loading the vehicle.....	84		
Three-stage safety system.....	85		
Three-point seat belts	85		
Belt tensioners.....	86		

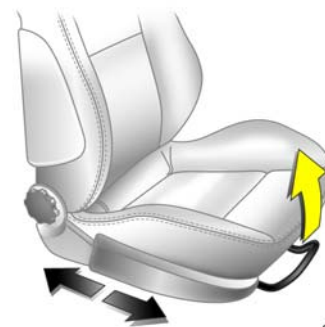

S 11510

Front seats

Warning

Never adjust seats while driving as they could move uncontrollably.

Adjust seat longitudinally

To adjust, pull the handle on the front seat, slide the seat and release the handle.

Warning

Important: Do not sit nearer than 10 inches (25 cm) from the steering wheel, to permit safe airbag deployment.



S 11511

Adjusting the backrest

To adjust, turn side handwheel on the seat while releasing the load on the backrest.

Move backrest to suit seating position.

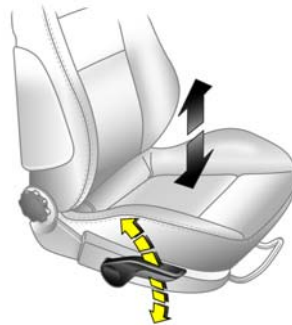

S 11512

Adjusting the seat height ✳

To adjust, operate lever on the outside of the seat.

Pump action on lever

Up: Seat higher

Down: Seat lower

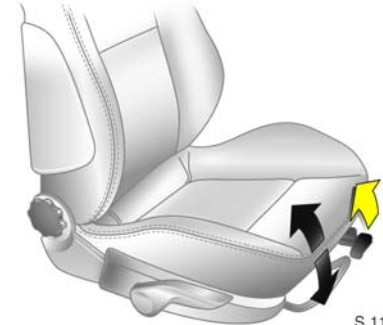

S 11513

Adjusting the seat angle ✳

To adjust, pull the lever on the front of the seat, adjust the angle and release the lever.

The seat should engage perceptibly.

Adjust the inclination by distributing body weight.

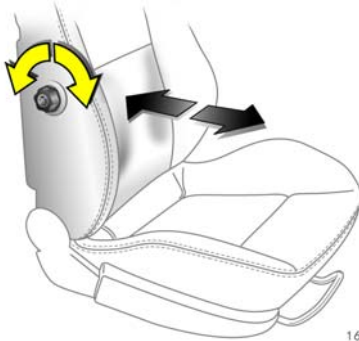

16972 T

Adjusting the lumbar support *

To adjust, turn side handwheel on backrest while relieving the load on the backrest.

Adjust lumbar support to suit personal requirements.

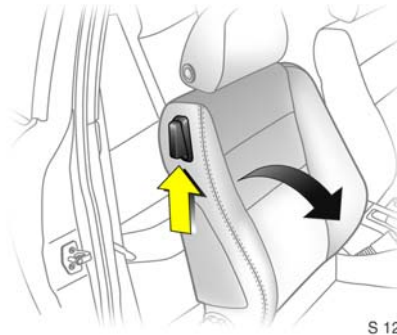

S 12057

Fold the seat backrest forwards *

To fold forwards, raise the release lever and fold the backrest forwards. Lower the release lever and the backrest engages in the forward-folded position *. Slide seat forwards *.

To straighten the seat, slide back and it engages in its original position *. Raise release lever *, straighten seat back, lower release lever, seat back engages.

For seat without memory function *: engage seat in desired position.

The seat back can only be tipped forwards from an upright position.

When the backrest is folded forward, do not activate the handwheel for backrest adjustment.

In vehicles with a panoramic window *: to tilt seats forward, push head restraints down and lift up sun visors.

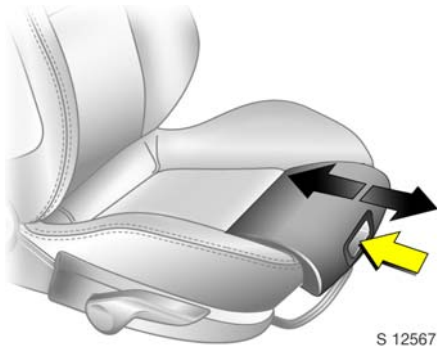

S 12567

Adjusting the thigh support * on the sports seats *

To adjust, press the button on the front of the adjustment padding and slide the thigh support.

Adjust thigh support to suit personal requirements.

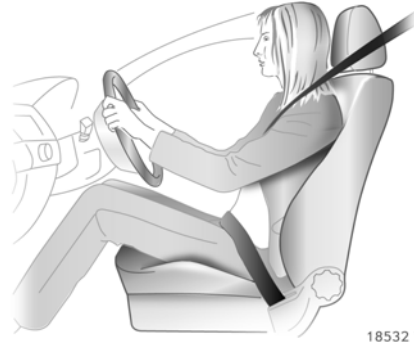

18532 T

Seat position

Adjust driver's seat such that with the driver sitting upright the steering wheel is held in the area of its upper spokes with the driver's arms slightly bent.

Push passenger seat as far back as possible.

The seat backrests must not be tilted too far back (recommended maximum tilting angle approx. 25°).

Warning

Failure to observe the descriptions could lead to injuries which could be fatal. Vehicle passengers should be informed accordingly before starting off.

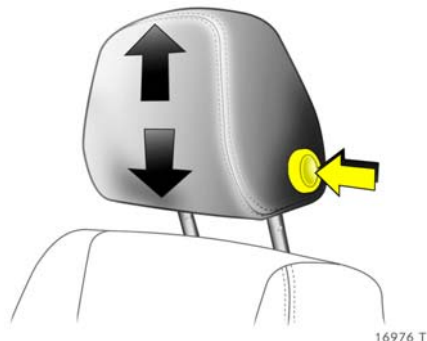

Head restraints

Adjusting the front head restraints and rear outboard head restraints *

To adjust, press button on side and adjust height.

To fold down the backrests (see page 71) or improve visibility when the rear seats are not occupied, remove the head restraints or push them all the way down.

If the seats are occupied, set height according to body size.

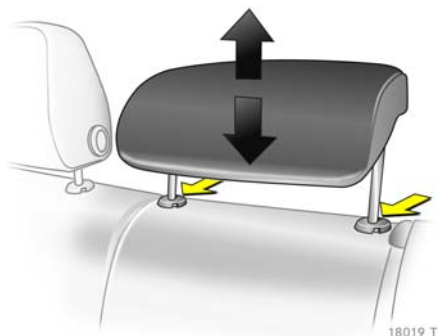

Adjusting the rear, centre head restraint *

To adjust, pull the head restraint up or press the catch to release. Then push the head restraint down.

To fold down the backrest (see page 71) or improve visibility when the centre rear seat is not occupied, remove the head restraint or push it all the way down.

If the seat is occupied, set height according to body size.



Adjusting the rear head restraints *, Astra TwinTop

To adjust, pull the head restraint up or press the two catches to release. Then push the head restraint down.

To improve visibility when the rear seats are not occupied, push the head restraints all the way down.

If the seats are occupied, set height according to body size.

Do not place any objects on the cover behind the head restraints or between the head restraints and the anti-roll bars *.

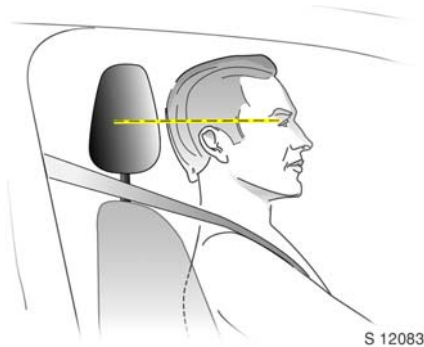

S 12083

Head restraint position

The middle of the head restraint should be at eye level. If this is not possible for extremely tall persons, set to highest position, and set to lowest position for small persons.

Warning

Failure to observe the descriptions can lead to injuries which could be fatal. Vehicle passengers should be informed accordingly before moving away.

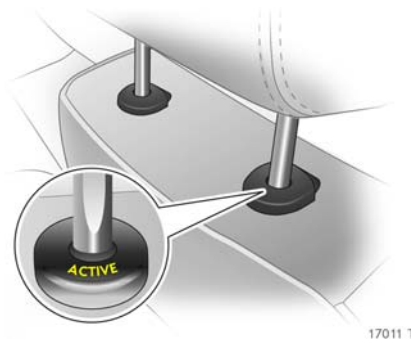

17011 T

Active head restraints *

In the event of a rear-end impact, the active head restraints tilt forwards slightly. The head is more effectively supported by the head restraint and the danger of whiplash in the neck area is reduced.

Active head restraints are identified by the lettering **ACTIVE** on the head restraint guide sleeves.

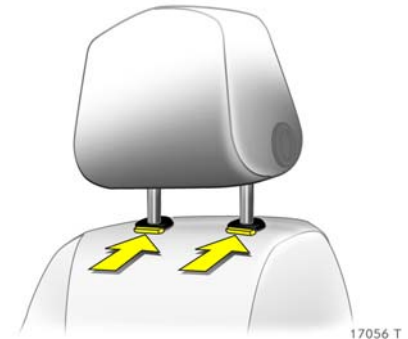

17056 T

Removing the head restraints

Press and release the two catches. Pull and remove the head restraint.

To fold down the backrests * (see page 71), push the rear head restraints all the way down or remove.

Note

Only approved objects or components should be attached to the head restraint of the unoccupied front passenger seat.

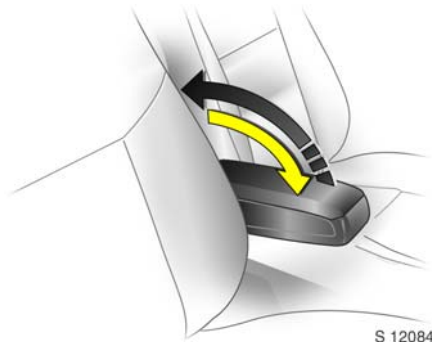

Armrest * at driver's seat

Push raised armrest backward against resistance and fold down.

The armrest can be moved to different positions in stages by lifting it.

If the armrest is not required it can be raised.

Stowage compartment in armrest – see page 110.

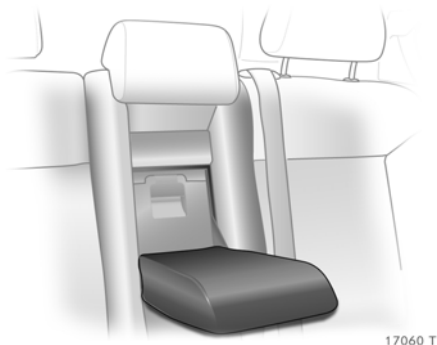

Armrest * in back seat backrest

Fold down the armrest, pulling the strap obliquely down (45°).

When the centre rear seat is in use or the rear backrests are folded, fold the armrest up.

A flap located behind the armrest facilitates transport of long, narrow objects – see page 71.



Astra TwinTop

Pull the armrest by the strap, pivot it down and position on the seat with the flat side up.

The armrest is held in place on the backrest with a retaining strap. To fully remove the armrest, disengage the bracket at the retaining strap.

A flap located behind the armrest facilitates transport of long, narrow objects – see page 75.

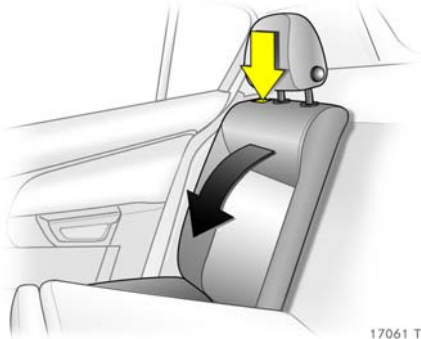

17061 T

Extending the luggage compartment, Hatch

Folding the rear seat backrests

Pushing rear head restraints all the way down or removing, see pages 68, 69.

Slide front seat forward slightly.

Disengage the backrest (single or split *) using the pushbutton and fold it down onto the seat cushion.

Return front seat to desired position.

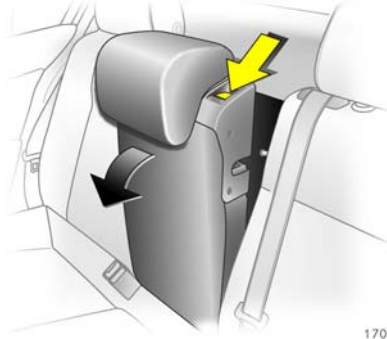

17062 T

Fold down centre backrest *

Push head restraint all the way down – see page 68.

Disengage backrest using lever and fold onto seat cushion.

Folding down the centre seat backrest makes it possible to load longer objects. The outer seats can still be used for occupants.

Warning

The load must not obstruct the operation of the pedals, handbrake or transmission or restrict the driver's freedom of movement. Do not place loose objects in the interior. Pay attention to notes on page 84.

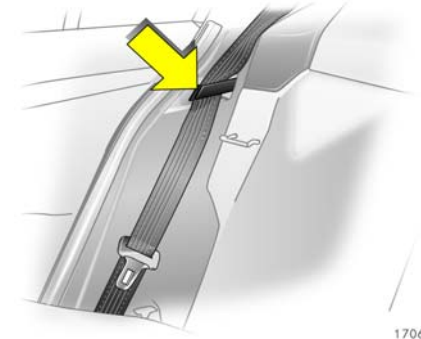

17063 T

Restoring backrest to an upright position

Guide the seat belt through the side bracket to protect against damage.

Catches must audibly engage when rear seat backrests are raised.

The three-point seat belt for the centre rear seat can only be pulled from its inertia reel if the backrest is properly engaged.

Notes on loading

See page 84.

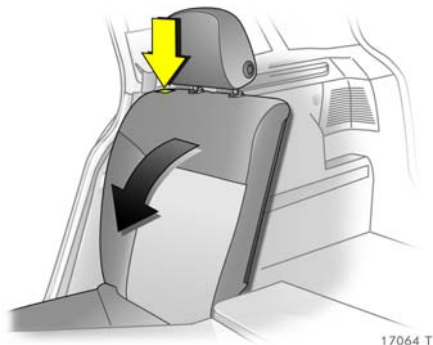

Extending the luggage compartment, Estate

Folding the rear seat backrests onto the seat cushion

Push the rear head restraints all the way down or remove, see pages 68, 69. To detach hooks of luggage compartment cover from head restraints, see page 77.

Slide front seat forward slightly.

Disengage the backrest (single or split *) using the pushbutton and fold it down onto the seat cushion.

Return front seat to desired position.

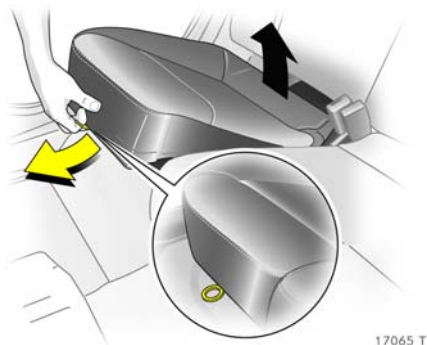

Raise the seat cushion and fold the backrest

Pull the strap on the seat cushion and raise the backrest towards the front (split * or one-piece).

Detach the hooks of the luggage compartment cover from the head restraints – see page 77.

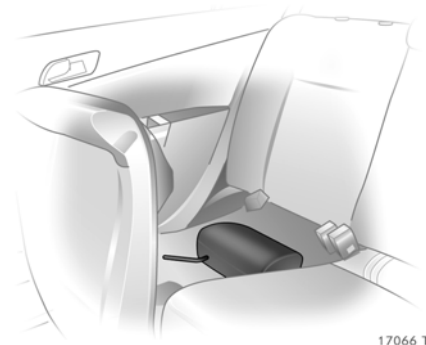

Remove rear outer head restraints. Push centre head restraint all the way down – see pages 68, 69.

Stow the removed head restraints in the cavity below the raised seat cushions.



Disengage backrest (one-piece or split ✱) using pushbuttons, fold forward and engage.

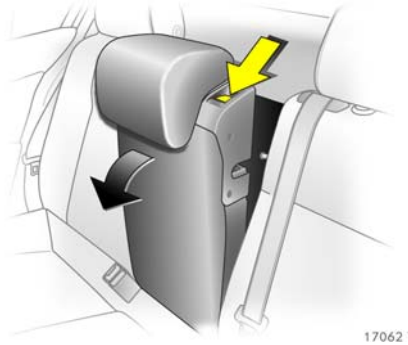

Fold down centre backrest ✱

Push head restraint all the way down – see page 68.

Disengage backrest using lever and fold onto seat cushion. If the seat cushion is raised, fold it forward until it engages.

Folding the centre seat backrest makes it possible to load longer objects. The outer seats can still be used for occupants.

⚠ Warning

The load must not obstruct the operation of the pedals, handbrake or transmission or restrict the driver's freedom of movement. Do not place loose objects in the interior. Pay attention to notes on page 84.

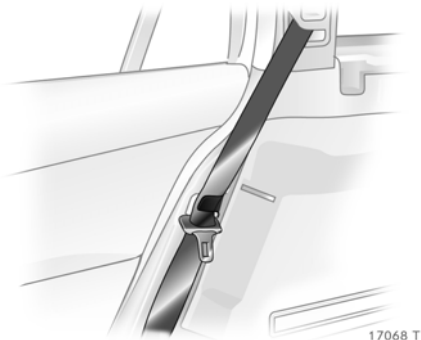

Restoring the backrests or seat cushions ❄ to their original position

Guide the seat belt through the side bracket to protect against damage.

To restore the backrest to an upright position, fold up, pressing the button on the backrest. Audibly engage the backrest in an upright position.

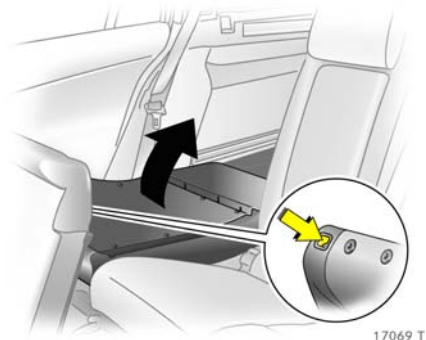

Raised seat cushions: Insert and adjust head restraints in backrests – see pages 68, 69. Fold back seat cushions, making sure the belt buckles are properly positioned.

Attach the hooks of the luggage compartment cover to the head restraints – see page 77.

The three-point seat belt for the centre rear seat can only be pulled from its inertia reel if the backrest is properly engaged.

Safety net ❄

See page 78.

Notes on loading

See page 84.

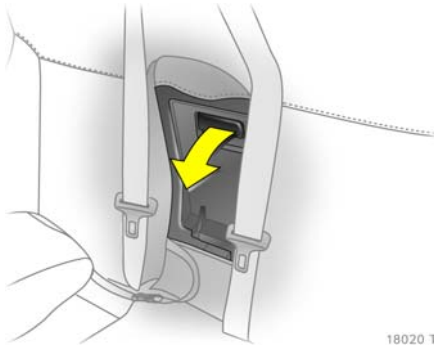

18020 T

Extending the luggage compartment, Astra TwinTop

Loading area between rear seats

Pull out the armrest by the strap.

The armrest is held in place on the backrest with a retaining strap. To fully remove the armrest, disengage the bracket at the retaining strap.

Pull the handle and fold down the cover.

Warning

The load must not obstruct the operation of the pedals, handbrake or transmission or restrict the driver's freedom of movement. Do not place loose objects in the interior. Pay attention to notes on page 84.

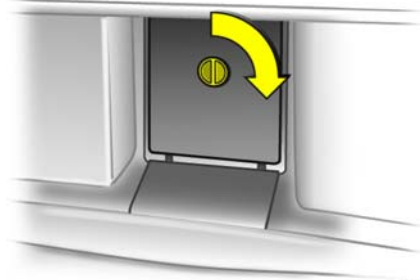

17984 T

Cover behind armrest can be locked from luggage compartment ✱: turn button 90°:

Locked = Horizontal button

Unlocked = Vertical button

Notes on loading

See page 84.



S 11569

Folding down the front passenger seat ✱

To push down and remove front passenger seat head restraint, see pages 68, 69.

Push front passenger seat back.

Fold front passenger seat forward by raising release lever.

To raise the backrest, push release lever forwards, raise front passenger seat backrest and audibly engage.

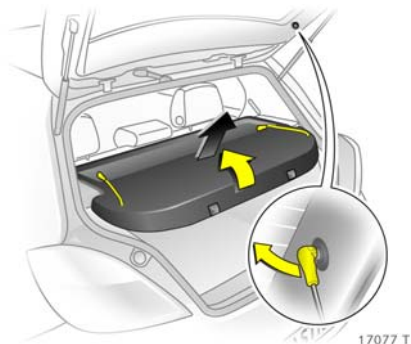

Luggage compartment cover

Hatch

Removing

Unhook retaining straps from tailgate.

Pull cover from the side guides.

Fitting

Engage cover in side guides and fold downwards. Attach retaining straps to tailgate.

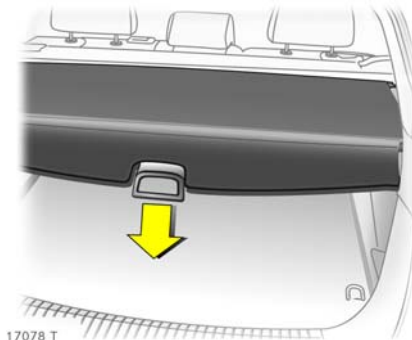

Estate

To open

Press handle on luggage compartment cover down. The cover automatically unrolls.

To close

Press handle on luggage compartment cover rearwards; the cover automatically engages in its end position.

Do not place any heavy or sharp-edged objects on the cover.

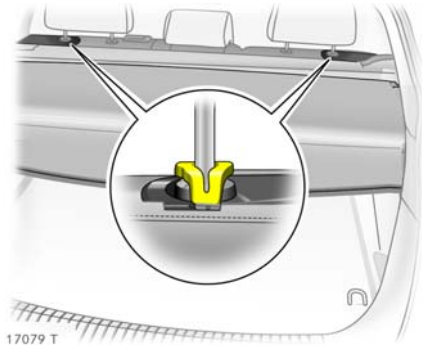

To cover the gap between the luggage compartment cover and the rear backrests, there is a cover on the cartridge. Attach the two hooks of the cover to the head restraint guide rods. If the safety net is mounted, run the hooks through the net mesh.

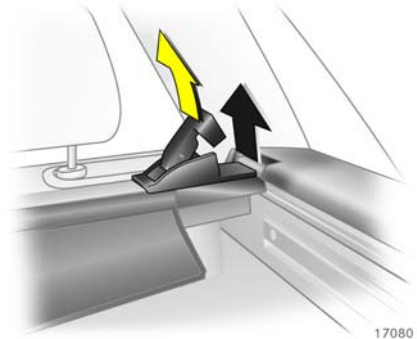

Removing

Open the luggage compartment cover and detach the hooks from the head restraints.

Raise release lever at right side of luggage compartment cover. Lift right side of cover first, then pull left side out of recess.

Fitting

Insert luggage compartment cover into recess on left, raise release lever on right side, insert cover into recess on right, engage and push lever down.

Attach the hooks on the head restraints - see Fig. 17079 T.

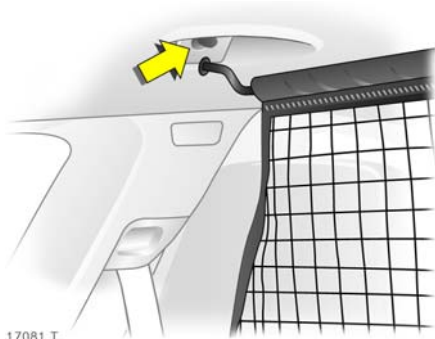

Safety net ✳, Estate

The safety net can be mounted behind the rear seats or, if the rear seat backrests are folded and the seat cushions raised, behind the front seats.

Passengers must not be carried behind the safety net.

Fitting behind the rear seats

Remove luggage compartment cover, see page 76

Unroll the safety net.

There are two brackets in the roof frame. Hook the net rods into the brackets on one side and then the other. Slide forward to engage.



Adjust strap length on safety net by attaching the upper hook to the eye of the strap, see Fig. 17085 T on page 79, and attach to eyes in the right and left of the floor.

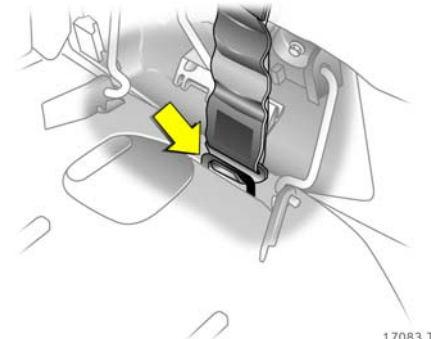

Fitting behind front seats

Raise the rear seat cushions, see page 72.

Unroll the safety net.

There are two brackets in the roof frame above the front seats. Hook the net rods into the brackets on one side and then the other. Slide forward to engage.

Adjust strap length on safety net by attaching the upper hook to the eye of the strap, see Fig. 17085 T on page 79, and attach to eyes in the right and left of the floor.

Remove rear outer head restraints and fold backrests forward, see pages 68, 69, 72.

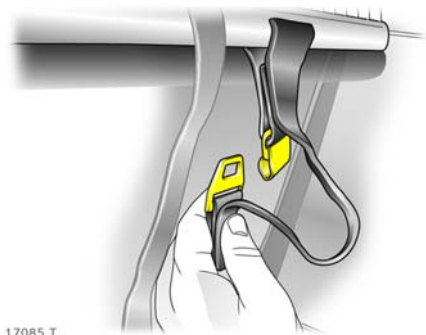

17085 T

Removing

Detach the safety net belt straps by tipping up the length adjuster.

Unhook the safety net rods from the brackets in the roof frame. Roll up the net and secure with a strap.

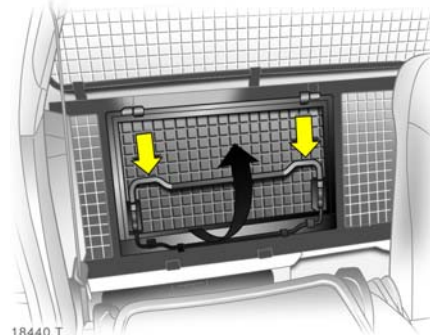

18440 T

Luggage compartment grille ✳, pick-up

To transport long objects, part of the luggage compartment grille behind the passenger seat can be opened:

Release passenger seat back and fold forward.

Press bracket down and fold grille section up.

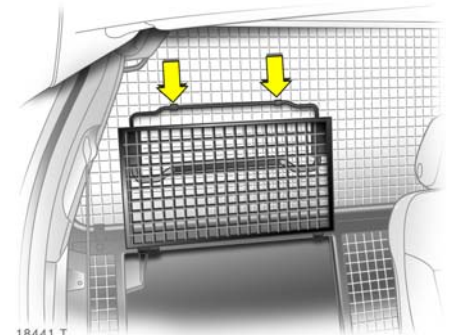

18441 T

Lock grille in open position.

Warning

The load must not obstruct the operation of the pedals, handbrake or transmission or restrict the driver's freedom of movement. Do not place loose objects in the interior. Pay attention to notes on page 84.

To close the grille section from the open position, push bracket down, fold down grille and engage, see Fig. 18441 T.

Check that the closed grille is properly locked.

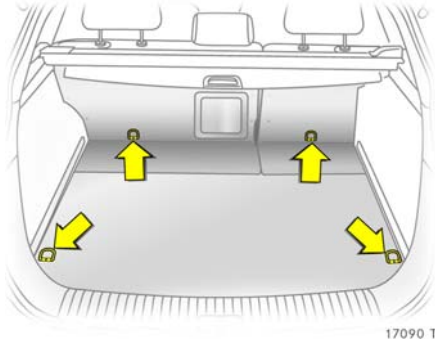

Lashing eyes *

in the luggage compartment are used to secure lashing straps * or a luggage net * to prevent objects that are being transported from sliding.

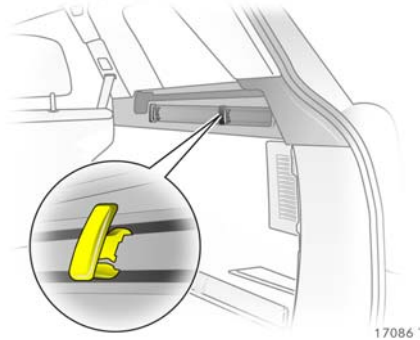

Rails and hooks in the luggage compartment *, Estate

The side walls of the luggage compartment house two rails. Insert the hooks in the desired position in the rails: insert the hook in the upper groove on the rail and press in the lower groove.

Pull off the hook to remove.

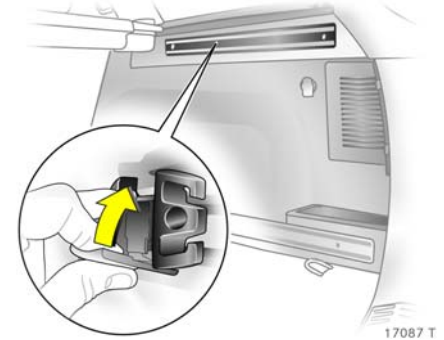

FlexOrganizer *

Flexible system for dividing the luggage compartment or securing loads in an Estate.

The system consists of

- Adapters
- Variable partition net
- Mesh pockets for the side walls
- Hooks in the luggage compartment

Components are mounted in the two guide rails in the side walls of the luggage compartment by means of adapters or hooks.

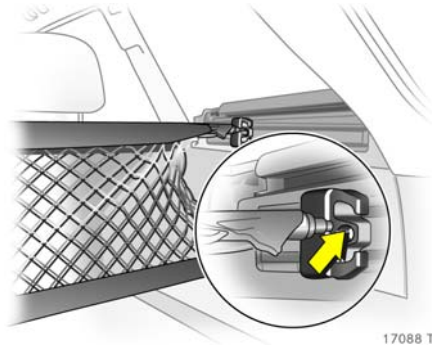

Variable partition net

Insert an adapter in each rail: Fold up handle plate, insert adapter in upper and lower groove of rails, move to desired position. To lock the adapter, swivel the handle plate up. Compress the rods of the partition net slightly and insert in corresponding openings of the adapter. The longer rod must be inserted in the upper adapter.

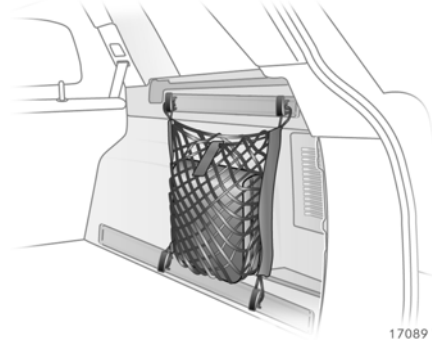

Hooks and mesh pockets for side walls

Insert hooks in rails in desired position: insert hook in upper groove in rail and push into lower groove. The mesh pocket can be suspended from the hooks.

Removing

Press the partition net rods together and remove from the adapters.

Adapter: fold open the retainer, release the adapter from the lower groove and remove from the upper groove.

Release the hooks from the rails.

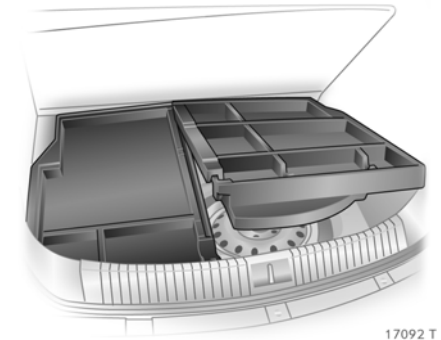

Cargo box *

Foldable box under the floor cover used to divide the luggage compartment.

The cargo box may only be loaded when the backrests are engaged in an upright position.

To remove the cargo box floor cover, remove first the right half then the left half. For models with towing equipment, first release the coupling ball bar fixing strap and thread this through the eye – see page 237. Installation in the reverse order.

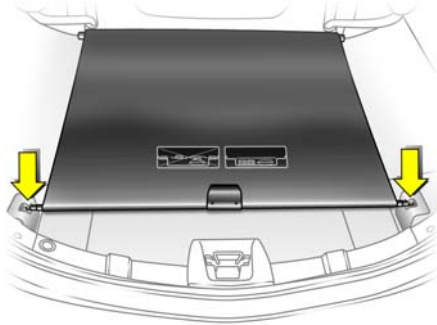

18024 T

Luggage compartment blind, Astra TwinTop

To open:

Release luggage compartment blind from recesses on left and right, blind rolls up automatically.

To close:

Grasp the handle, pull the blind towards the rear of the vehicle and engage in the recess on the right and left.

Do not place any objects on the luggage compartment blind.

There must be no objects outside of or on top of the luggage compartment blind when the roof is open or in the process of opening.

The roof can only be operated with the luggage compartment blind engaged in the recess.

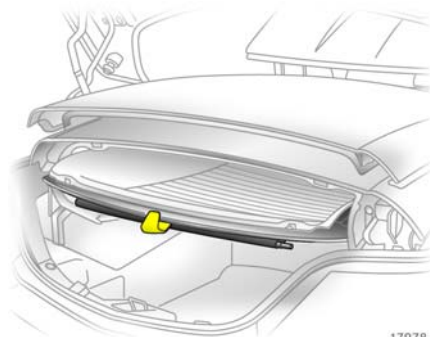

17978 T

Easy Load (Electronically operated loading aid for the luggage compartment of the Astra TwinTop)

The loading aid makes it possible to comfortably load the luggage compartment when the roof is open. The press of a button will raise the roof folded up in the luggage compartment 25 cm. This enlarges the load opening of the luggage compartment.

- Open the boot lid.
- Unhook luggage compartment blind and attach to rear window frame with holder, see Fig. 17978 T>

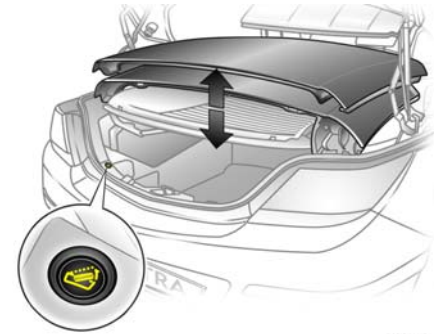

17977 T

- Briefly press button : The folded roof is raised. The roof remains in this end position for approx. 9 minutes.

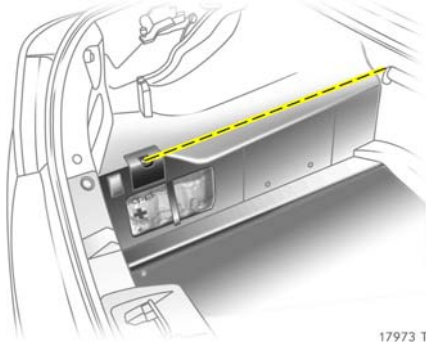

17973 T

- Load luggage compartment at most to marked load height, otherwise the roof and load could be damaged.
- Suspend the luggage compartment blind from the rear window frame, and engage in recesses on right and left. The luggage compartment blind must be flat; objects underneath it must not push it upwards.
- Briefly press button : The folded roof is lowered.
- Close the boot lid only after the confirmation signal has sounded. Otherwise the roof could be damaged.

Warning

Take care when operating the loading aid. Risk of injury.

Make sure that nothing could be pinched.

Make sure no one is in the action zone during operation. Risk of injury.

This is especially important for children. Inform passengers accordingly.

Note

- Do not place objects on or near the luggage compartment blind.
- The folded roof can only be lowered when the blind is closed. Otherwise, a warning buzzer will sound three times.
- The movement of the tilted roof can be stopped by pressing button  and another longer press reverses the direction of the movement.
- A confirmation buzzer is heard in the upper and lower roof end positions when the roof is tilted.

- Only close the boot lid once the confirmation signal has sounded to indicate that the loading aid is in its lower end position.
- If the loading aid is not in its lower end position when the boot lid is closed, a warning tone sounds or the boot lid is blocked mechanically , see page 61.
- Do not touch moving parts.
- One minute before the end of the hold time for the raised loading aid, a warning buzzer will sound to remind you to lower the roof.
- The loading aid is only operable when the vehicle is unlocked.
- Frequent operation of the loading aid with the engine off runs the battery down.
- Repeated operation of the loading aid without breaks can cause overloading and therefore malfunctions.

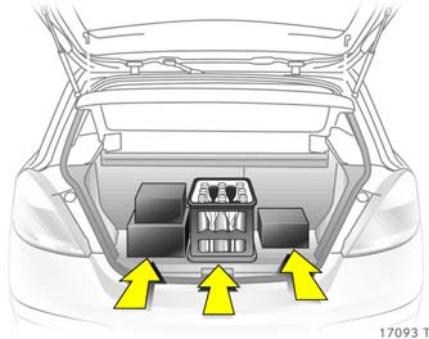

Notes on loading the vehicle

- Heavy objects in the luggage compartment should be placed against the engaged rear seat backrests * or, if the rear seat backrests are folded down, against the front seat backrests. If objects are to be stacked, the heavier objects should be placed at the bottom. Unsecured objects in the luggage compartment would be thrown forward with great force in the event of heavy braking, for example.
- Secure objects with lashing straps * attached to lashing eyes, see page 80. If heavy loads slip when the vehicle is braked heavily or driven around a bend, the handling of the vehicle may change.
- Estate: mount the safety net * when transporting objects in the luggage compartment – see page 78.
- Estate: close luggage compartment cover – see page 76.
- If the backrests are not folded down when transporting objects in the luggage compartment, they must be engaged in their upright position * – see pages 71, 74.
- Do not allow the load to protrude above the upper edge of the rear seat backrests, or above the upper edge of the front seat backrests if the rear seat backrests * are folded down.
- Astra TwinTop: pay attention to maximum loading height with roof open, see Fig. 17973 T on page 82. Do not place objects on top of or next to the luggage compartment blind.
- The warning triangle * and first-aid kit (cushion) * must always be freely accessible.
- Do not place any objects in front of the rear window or on the instrument panel. They are reflected in the glass, obstruct the driver's view and will be thrown through the vehicle, for instance in the event of heavy braking.
- The load must not obstruct the operation of the pedals, the handbrake or the gears or restrict the driver's freedom of movement. Do not place loose objects in the interior.
- Astra TwinTop: Do not place any objects on the cover of the deployable anti-roll bars *, behind the rear head restraints or in the luggage compartment outside of, on or next to the luggage compartment cover.
- Do not place objects in the expansion range of airbags or extending anti-roll bars *, since this poses a risk of injury if the systems are actuated.
- Do not drive with luggage compartment open when transporting bulky objects, for example, since toxic exhaust fumes could penetrate the interior.
- Weights, payload and roof load – see page 325.
- Driving with a roof load – see pages 198, 200, 232 – increases the sensitivity of the vehicle to crosswinds and has a detrimental effect on vehicle handling owing to the vehicle's higher centre of gravity.

Warning

Failure to observe these descriptions can lead to injuries which may be fatal. Vehicle passengers should be informed accordingly.

Three-stage safety system

Comprising:

- Three-point seat belts
- Belt tensioners at the front seats
- Airbag systems for driver, front seat passenger and rear outboard seats ✱. On Astra TwinTop ✱, roll-over bar behind rear seats.

The three stages are activated in sequence depending on the severity of the accident:

- The automatic seat belt locking devices prevent the belt strap from being pulled out and thus ensure that the vehicle occupants are retained in their seats.
- The front seat belts are pulled down at the belt buckles. This means the belts fit snugly, the occupants are decelerated early with the vehicle and the body loading is reduced.
- In the event of a severe accident, the airbag systems and deployable anti-roll bars ✱ also deploy, forming safety cushions for the occupants. The front airbags are inflated in two stages based on the severity of the collision.

⚠ Warning

The airbag systems and anti-roll bars ✱ serve to supplement the three-point seat belts and belt tensioners. The seat belts must therefore always be worn. Disregard of these instructions could lead to injuries or endanger life. Vehicle passengers should be informed accordingly.

Read the instructions supplied with the child restraint system!



18533 T

Three-point seat belts

The vehicle is equipped with three-point seat belts with automatic retractors and locking devices, allowing freedom of body movement although the spring tensioned seat belts always ensure a snug fit.

For information on correct seating position, see pages 67, 88, 94.

The seat belts are locked during heavy acceleration or deceleration of the vehicle.

Warning

Always wear your seat belt, and that means also in urban traffic and when you are a rear seat passenger. It can save your life!

Pregnant women must always wear a seat belt, see page 88.

In the event of an accident, persons not wearing seat belts endanger their fellow occupants and themselves.

Control indicator  for the seat belt – see page 114.

Seat belts are only intended for one person. They are not suitable for anyone under 12 years of age or under 150 cm tall.

For children up to 12 years of age, we recommend the Vauxhall child restraint system, see page 90.

Belt force limiters

on the front seat safety belts, reduce the stress on the body by damping the release of the seat belt during a collision. The forward movement of the body is therefore controlled.

Checking the seat belts

Check all parts of the belt system periodically for damage and function. Replace damaged components. After an accident, have the seat belts and deployed belt tensioners replaced by a workshop.

Do not modify the seat belts, their anchorages, the automatic retractors or the belt buckles in any way.

Make sure that seat belts are not damaged or trapped by sharp-edged objects.

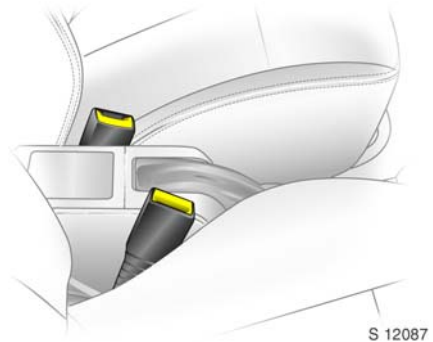

Belt tensioners

The front seat belts are fitted with belt tensioners. The seat belts are pulled down at the buckles in the event of a front or rear-impact above a certain severity. This tightens the seat belts.

Actuation of belt tensioners

is indicated by illumination of control indicator , see following page.



If the belt tensioners are triggered, they must be replaced by a workshop.

Important information, see page 87.



17105 T

Control indicator for belt tensioners

The function of the belt tensioners is monitored electronically together with the airbag systems and the deployable anti-roll bars . Their operational readiness is indicated by control indicator  in the instrument panel. When the ignition is switched on, the control indicator illuminates for approx. 4 seconds. If it does not illuminate, does not go out after 4 seconds or illuminates whilst driving, there is a fault in the belt tensioner or and airbag systems or in the deployable anti-roll bars , see page 98. The systems may fail to trigger in the event of an accident.

Deployment of the belt tensioners is indicated by continuous illumination of .

Warning

Have the cause of the fault eliminated immediately by a workshop.

The system's integrated self-diagnostics allows faults to be quickly remedied.

Important

- Affixing or placing accessories and other objects not specifically approved for your vehicle type within the action zone of the belt tensioners (near the belt buckles) is not permitted, since this could result in injury if the belt tensioners are actuated.
- Do not make any modifications to the components of the belt tensioners, as this will render the vehicle unroadworthy.

Warning

Incorrect handling (e.g. removal or fitting of seat belts or belt buckles) can actuate the belt tensioners, with risk of injury.

- The belt tensioner and airbag system control electronics can be found in the centre console area. In order to avoid malfunctions, do not store magnetic objects in this area.
- When the rear seats are being used, please ensure that the components of the front seat belts are not damaged by shoes or other objects. Do not allow dirt to penetrate the automatic retractors of the seat belts.
- We recommend that you have the front seats removed by a workshop.
- The belt tensioners trigger once only, indicated by illumination of control indicator . Belt tensioners when triggered must be replaced by a workshop.
- When disposing of the vehicle, the safety instructions given for this must be observed. Take the vehicle to a recycling company for disposal.

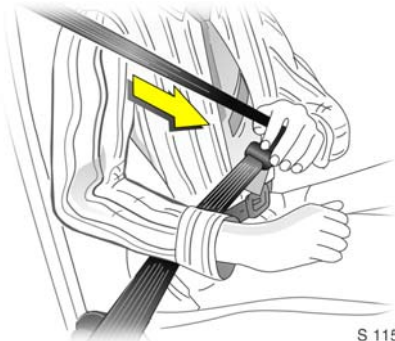

S 11541

Operating the seat belts

Fitting seat belts

Pull seat belt out of retractor and guide across the body, making certain that it is not twisted.

Insert the latch plate into the buckle. The front seat backrest must not be tilted back too far or the seat belt will not operate properly. The recommended angle of inclination is 25°. Make sure that the lap belt is not twisted and that it fits snugly across the body. Tension the belt frequently while driving by tugging the diagonal part of the belt.



17107 T

Warning

On pregnant women in particular, the lap belt must be positioned as low as possible across the pelvis so as not to put too much pressure on the abdomen.

Loose clothing affects the snug fit of the seat belt. The seat belt must not be routed over hard or breakable objects in the pockets of your clothing (e.g. ballpoint pens, keys, glasses) because this can cause injuries. Do not place objects (e.g. handbags, mobile phones) between the seat belt and your body.

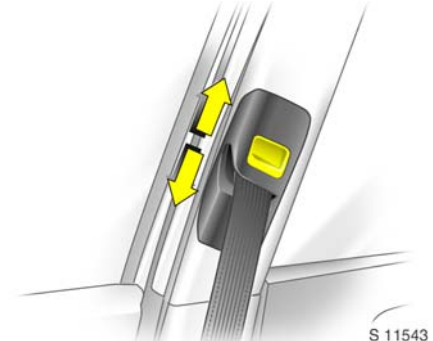

S 11543

Height adjustment *

Adjusting the height of the upper deflection point of the front seat belts:

1. Pull out seat belt a little way.
2. Press down button on adjuster slide.
3. Move adjuster slide up or down.
4. Allow sliding adjuster to audibly latch.

Do not adjust height while driving.



18533 T

Adjust height such that seat belt passes over wearer's shoulder and rests against the shoulder. It must not pass over the neck or upper arm.

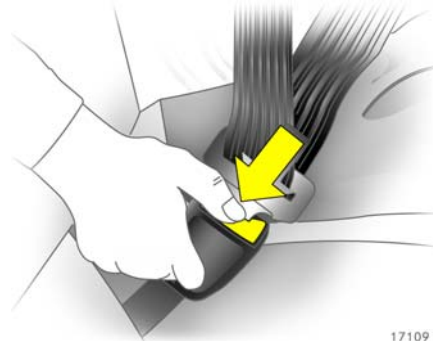

17109 T

Removing the belt

To remove seat belt, press red button on buckle and seat belt will retract automatically.

Three-point seat belts on rear outer seats
When not in use, pass seat belts through side holders * as shown in Fig. 17063 T on page 71.

Three-point seat belt of centre rear seat *
The seat belt can only be pulled from the inertia reel when the backrests are upright and properly engaged – see page 71.

Three-point seat belts of rear seats in Astra TwinTop

To prevent the seat belts from making flapping noise when the sunroof and/or the windows are open, the seat belts of unoccupied rear seats can be secured behind the armrest.

Child restraint system *

When a child restraint system is used, follow the instructions for use and installation.

The country in which you are travelling may not permit the use of child restraint systems on certain seats. Always comply with the local or national regulations.

Selecting the right system

Your child should travel facing backwards in the car for as long as possible. A child has a very weak cervical spinal column and in the event of an accident is less likely to suffer injury in a rearward-facing, semi-lying position than if seated upright.



Warning

Never carry child restraint systems on your lap, risk of fatal injury.

Permissible options for fitting a child safety seat¹⁾

Weight and age class²⁾	On front passenger seat	On outer rear seats	On centre rear seat³⁾
Group 0: up to 10 kg or approx. 10 months	B ¹ , +	U, +	U
Group 0+: up to 13 kg or approx. 2 years			
Group I: 9 to 18 kg or approx. 8 months to 4 years	B ² , +	U, +	U
Group II: 15 to 25 kg or approx. 3 to 7 years	X	U	U
Group III: 22 to 36 kg or approx. 6 to 12 years			

¹⁾ For reasons of safety, we recommend that the child safety seat be installed on one of the outer rear seats.

²⁾ We recommend the use of each system until the child reaches the upper weight limit.

³⁾ Not on Astra TwinTop.

B¹ = Limited, only with seat occupancy recognition and Vauxhall child restraint system with transponders.

If the child restraint system is being secured using a three-point seat belt, move seat height adjustment ✱ to uppermost position. Move front passenger seat as far back as possible and move front passenger seat belt anchorage point to lowest position.

B² = Limited, only with seat occupancy recognition and Vauxhall child restraint system with transponders.

If the child restraint system is being secured using a three-point seat belt, move seat height adjustment ✱ to uppermost position. Move front passenger seat as far back as possible so that vehicle safety belt runs from anchorage point towards the front.

U = Universal suitability in conjunction with three-point seat belt.

+ = Vehicle seat with ISOFIX fixings available. When using ISOFIX, only ISOFIX child restraint systems approved for the vehicle may be used.

X = No child restraint system permitted in this weight class.

Note

- Children under 12 years or less than 150 cm tall should always travel in an appropriate child restraint system.
- When transporting children, use the child restraint systems suitable for the child's weight.
- Ensure correct installation of child restraint system, see the instructions enclosed with the system.
- The covers of the Vauxhall child restraint system can be wiped clean.
- Do not stick anything on the child restraint systems and do not cover them with any other materials.
- Only allow the child to enter and exit on the side of the vehicle facing away from the road.
- A child restraint system which has been subjected to stress in an accident must be replaced.
- Secure or remove child restraint systems carried in the vehicle when not in use.

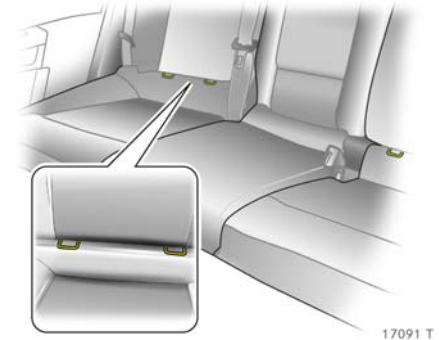

Mounting brackets ✱ for ISOFIX child restraint systems

The brackets located between the backrest and seat cushion are used for mounting ISOFIX child restraint systems.

Please follow the instructions accompanying the ISOFIX child restraint system.

Only ISOFIX child restraint systems approved for the vehicle may be used.

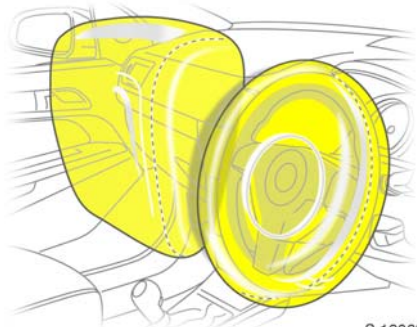

Vauxhall Full Size airbag system

The Vauxhall Full Size airbag system consists of several separate systems.

Front airbag system

The front airbag system will be triggered in the event of a serious accident involving a frontal impact and forms safety cushions for the driver and front passenger. The forward movement of the driver and front passenger is checked and the risk of injuries to the upper body and head thereby substantially reduced.

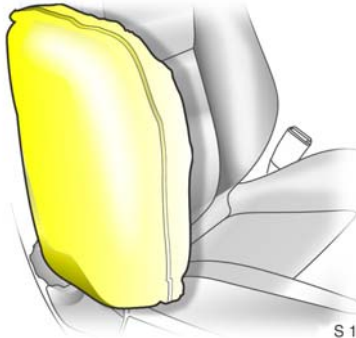

Side airbag system ❖

The side airbag is triggered in the event of a side-on collision to form a safety cushion for the driver or front passenger in the respective door area. This substantially reduces the risk of injury to the upper body and pelvis.

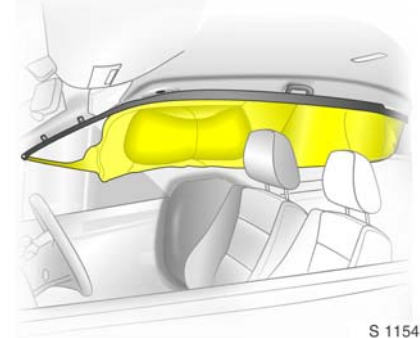

Curtain airbag system ❖

The curtain airbag system triggers in case of a side-on collision and provides a safety barrier in the head area on the respective side of the vehicle. This reduces the risk of injury to the head considerably in case of a side-on collision.



17111 T

Vauxhall Full Size airbag system

Front airbag



The front airbag system is identified by the word **AIRBAG** on the steering wheel and above the glove compartment.

The front airbag system comprises:

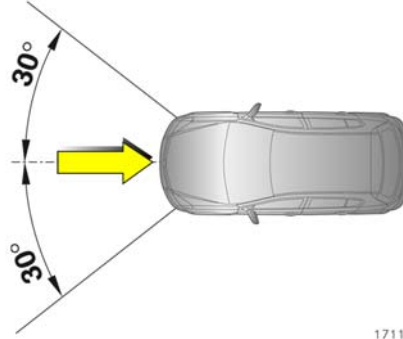

- an airbag with inflator in the steering wheel and a second one in the instrument panel,
- control electronics with impact sensors,
- control indicator for airbag systems  in instrument panel,







17112 T

- seat occupancy recognition ,
- the control indicator for Vauxhall child restraint systems  with transponders  in the instrument panel.

The front airbag system will be triggered:

- depending on the severity of the accident,
- depending on the type of impact,
- within the range shown in the illustration,
- independent of side airbag  and curtain airbag system .

Exception:

Passenger seat with seat occupancy recognition system . The seat occupancy recognition system deactivates the front and side airbags on the passenger side  if the front passenger seat is unoccupied or a Vauxhall child restraint system with transponders  has been fitted to the front passenger seat. Seat occupancy recognition, see page 99. Vauxhall child restraint system with transponders , see page 90.

Examples of events triggering the front airbag system:

- Impact against a non-yielding obstacle: the front airbags are triggered at low vehicle speed.
- Impact against a yielding obstacle (such as another vehicle): the front airbags are only triggered at a higher vehicle speed.

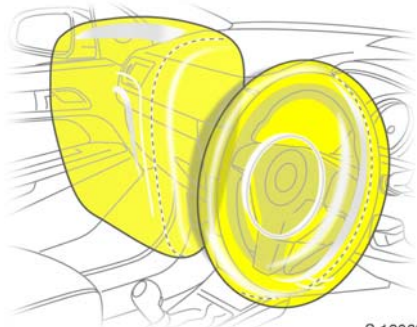

S 12069

When triggered, the front airbags inflate in milliseconds to form a safety cushion for the driver and front passenger. The forward movement of the front seat occupants is checked, thereby substantially reducing the risk of injury to the upper body and head.

No impairment of view will occur, because the airbags inflate and deflate so quickly that it is often not even noticed in an accident.

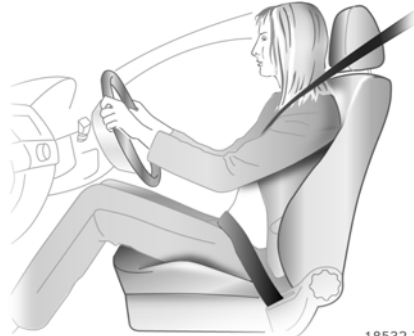

18532 T

⚠ Warning

The front airbag system provides optimum protection when the seat, backrest and head restraint are correctly adjusted: Adjust the driver's seat according to the occupant's height such that with the driver sitting upright the steering wheel is held in the area of its upper spokes with the driver's arms slightly bent. The passenger seat should be as far back as possible, with the backrest upright, see pages 3, 67. Do not place the head, body, hands or feet on the covers of the airbag systems.

Do not place any objects in the area in which the airbags inflate. Important information, see page 101.



18533 T

⚠ Warning

The three-point seat belt must be correctly fitted, see page 88.

The front airbag system will not be triggered in the event of

- the ignition is switched off
- minor frontal collisions
- accidents in which the vehicle overturns
- collisions involving a side or rear-impact

that is to say, if it would not be of benefit to the occupants.

Warning

Seat belts must therefore always be worn. The front airbag system serves to supplement the three-point seat belts. If you do not wear your seat belt you risk being seriously injured, or even thrown from the vehicle, in the event of an accident.

In the event of an accident the seat belt helps to keep you seated in the correct position, so that the front airbag system can provide you with effective protection.

In addition, the front airbag system will not be triggered for the front passenger in versions with seat occupancy recognition * if

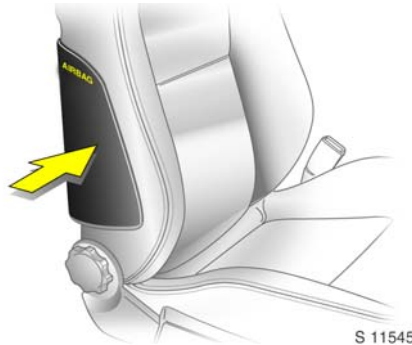

- the front passenger seat is unoccupied,
 - there is a properly fitted Vauxhall child restraint system with transponders *.
- Seat occupancy recognition, see page 99. Vauxhall child restraint system with transponders *, see page 90.



Side airbag *

The side airbag system is identified by the word **AIRBAG** on the outboard sides of the front seat backrests.

The side airbag system comprises:

- an airbag with inflator in the back of the driver's and front passenger seat respectively,
- the control electronics,
- the side-impact sensors,
- control indicator for airbag systems  in instrument panel,
- seat occupancy recognition *,
- the control indicator for Vauxhall child restraint systems  with transponders * in the instrument panel.

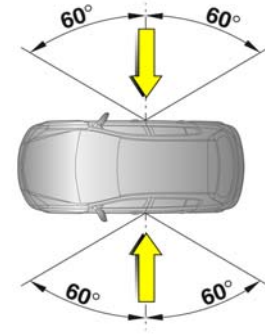

The side airbag system will be triggered:

- depending on the severity of the accident,
- depending on the type of impact,
- within the range shown in the illustration on the centre door pillar of the driver's or front passenger side,
- independently of the front airbag system.

Exception:

Passenger seat with seat occupancy recognition system *. The seat occupancy recognition system deactivates the front and side airbags on the passenger side * if the front passenger seat is unoccupied or a Vauxhall child restraint system with transponders * has been fitted to the front passenger seat. Seat occupancy recognition, see page 99. Vauxhall child restraint system with transponders *, see page 90.

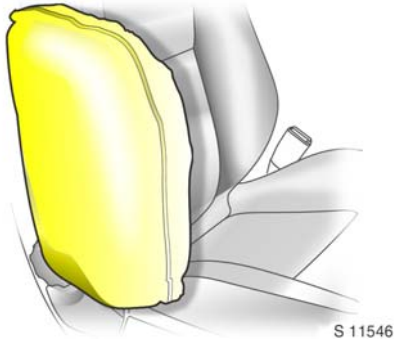

When triggered, the side airbag inflates within milliseconds to form a safety cushion for the driver or front passenger in the respective door area. This substantially reduces the risk of injury to the upper body and pelvis in the event of a side-on collision.

Warning

There must be no objects in the area in which the airbag inflates or in the area between the seat backs and the vehicle body. Do not place the hands or arms on the covers of the airbag systems. Important information, see page 101.

The three-point seat belt must always be correctly fitted, see page 88.

The side airbags will not be triggered in the event of

- the ignition is switched off
- frontal collisions
- accidents in which the vehicle overturns
- collisions involving a rear-impact
- side-on collisions outside the passenger cell.

In addition, the side airbag system * will not be triggered for the front passenger in versions with seat occupancy recognition * if

- the front passenger seat is unoccupied
- there is a properly fitted Vauxhall child restraint system with transponders *. Seat occupancy recognition, see page 99. Vauxhall child restraint system with transponders *, see page 90.



S 11547

Curtain airbag ✱

The curtain airbag system is identified by the word **AIRBAG** on the roof pillar trim.

The curtain airbag system comprises:

- an airbag with inflator in the roof frame on the driver's and front passenger side respectively,
- the control electronics,
- the side-impact sensors,
- control indicator for airbag systems ✱ in instrument panel.

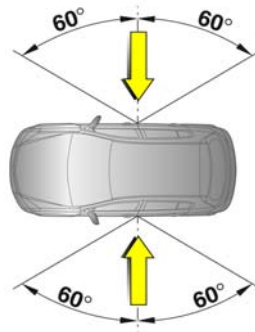

17114 T

The curtain airbag system will be triggered:

- depending on the severity of the accident,
- depending on the type of impact,
- within the range shown in the illustration on the centre door pillar of the driver's or front passenger side,
- together with the side airbag system ✱,
- irrespective of seat occupancy recognition ✱,
- independently of the front airbag system.

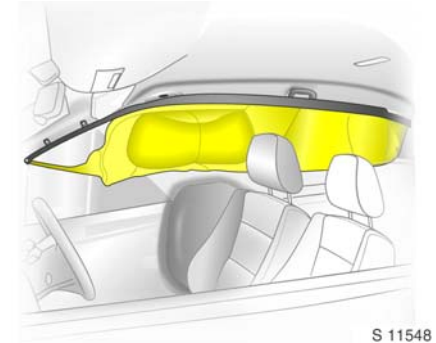

S 11548

When the curtain airbag is triggered it inflates within milliseconds and provides a safety barrier in the head area on the respective side of the vehicle. This reduces the risk of injury to the head considerably in case of a side-impact.

Warning

There must be no objects in the area in which the airbag inflates. Do not place the hands or arms on the covers of the airbag systems. Important information, see page 101.

The three-point seat belt must always be correctly fitted, see page 88.





The curtain airbags will not be triggered in the event of

- the ignition is switched off
- frontal collisions
- accidents in which the vehicle overturns
- collisions involving a rear-impact
- side-on collisions outside the passenger cell.



17105 T

Control indicator for airbag systems

The function of the airbag systems is monitored electronically together with the seat occupancy recognition  and belt tensioner systems and the deployable anti-roll bars . Their operational readiness is indicated by a control indicator . When the ignition is switched on, the control indicator illuminates for approx. 4 seconds. If it does not illuminate, does not go out after 4 seconds or illuminates whilst driving, there is a fault in the airbag systems, seat occupancy recognition  or belt tensioner systems, or in the deployable anti-roll bars , see page 87. The systems may fail to trigger in the event of an accident.

Deployment of the airbags is indicated by continuous illumination of .



Warning

Have the cause of the fault eliminated immediately by a workshop.

The system's integrated self-diagnostics allows faults to be quickly remedied.

Seat occupancy recognition*

The seat occupancy recognition system deactivates the front and side airbags* for the front passenger if the front passenger seat is not occupied or a Vauxhall child restraint system with transponders* is fitted on the front passenger seat. The curtain airbag system* remains activated.

The control indicator  for seat occupancy recognition is located in the instrument panel. If the control indicator  illuminates for approx. 4 seconds when the ignition is switched on, the vehicle is equipped with seat occupancy recognition, see Fig. 17117 T on page 100.

If a Vauxhall child restraint system with transponders* is fitted, the control indicator  illuminates continuously after the ignition is switched on as soon as the system has detected the child restraint system. Only then may the child restraint system with transponders* be used on the passenger seat.



17116 T

Vehicles with seat occupancy recognition are also identified by a sticker on the lower panel of the front passenger seats – see figure above.

Vauxhall child restraint systems with transponders* are automatically detected if correctly fitted to the front passenger seat. When this type of child restraint system is in use on the front passenger seat, the front and side airbag systems for the front passenger seat are deactivated. The curtain airbag system remains activated. Pay attention to control indicator  for seat occupancy recognition* see page 100.

Warning

Only Vauxhall child restraint systems with transponders* can be fitted on the front passenger seats. Use of systems without transponders poses a risk of fatal injury.

Vauxhall child restraint systems with transponders* can be identified by a sticker.

Note

On the Astra TwinTop, there may be interference in radio reception of certain frequencies in the medium waveband when the roof is open and the front passenger seat is unoccupied.

Control indicator  for Vauxhall child restraint systems with transponders *

The presence of a Vauxhall child restraint system with transponders * is indicated after the ignition has been switched on by continuous illumination of the control indicator  in the instrument panel, as soon as the seat occupancy recognition system has detected the child restraint system.

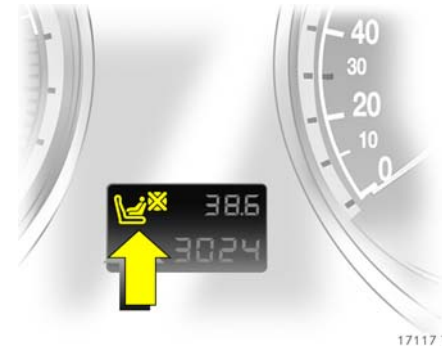

If the control indicator does not come on while driving, the front and side airbags * for the passenger are not deactivated and there is a risk of injury or death to the child. Fit child restraint systems on the rear seat. Have the cause of the fault eliminated by a workshop.

If the child restraint system is not correctly installed or the transponder is faulty, the control indicator flashes. Check for correct installation of child restraint system. To install the child restraint system with transponders *, see the instructions enclosed with the system.

If the control indicator flashes when the child restraint system with transponders * is correctly fitted, there is a fault with risk of injury to the child. Fit child restraint systems on the rear seat. Have the cause of the fault eliminated by a workshop.

If no Vauxhall child restraint system with transponders * is fitted, the control indicator must not illuminate or flash as the passenger airbag systems would not deploy. Have the cause of the fault eliminated by a workshop.

 Warning

If the Vauxhall child restraint system with transponders * has been fitted according to the instructions, the control indicator for Vauxhall restraint systems with transponders must illuminate in the instrument panel when the ignition is switched on.

If the control indicator does not come on while driving, the airbag systems for the passenger are not deactivated and there is a risk of fatal injury. In this case, fit child restraint systems on the rear seat. Have the cause of the fault eliminated by a workshop.

Important

- Do not affix or place accessories or other objects within the expansion range of airbag systems or extending anti-roll bars * is not permitted, since this could result in injuries if the components are actuated.
- Do not place any objects between the airbag systems/anti-roll bar covers * and the occupants. Risk of injury.

 Warning
Never carry child restraint systems or other objects on your lap – risk of fatal injury.

- Use the hooks in the roof frame only to hang up light articles of clothing or coat hangers. Do not place any objects in the pockets of the hanging items – risk of injury.
- The control electronics of the airbag systems, belt tensioners and deployable anti-roll bars * are located in the centre console area. Do not store any magnetic objects in the area as they could cause malfunction.
- Do not bond or use other material to cover the steering wheel, dashboard, front seat backrests and roof frame in the area of the airbags and the seat cushion of the passenger seat or the covers of the deployable anti-roll bars *.
- Use only a dry cloth or interior cleaner to clean the steering wheel, instrument panel, front seat backrests, roof frame and seat cushion of the front passenger seat. Do not use any aggressive cleaning agents.
- Only protective covers which are approved for your vehicle with side airbag * may be fitted on the front seats. When fitting the protective covers, make sure that the airbag units on the outboard sides of the front seat backrests are not covered.
- The airbag systems are triggered independently of each other based on the severity of the accident and the type of impact. The side airbag system * and the curtain airbag system * are triggered together.
- Astra TwinTop: The deployable anti-roll bars * are deployed together with the front and side airbag systems * depending on the severity of the impact.

- Each airbag or deployable roll-over bar * deploys once only. Have a workshop replace deployed airbags immediately.
- The speeds, directions of movement and deformation properties of the vehicles, and the properties of the obstacle concerned, determine the severity of the accident and triggering of the airbags. The degree of damage to your vehicle and the resulting repair costs alone are not indicative that the criteria for triggering of the airbags were met.
- Do not make any modifications to components of the airbag systems or the anti-roll bars * as this would render the vehicle unroadworthy.

 Warning
The systems can be triggered abruptly and cause injury if they are handled improperly.

- We recommend having the steering wheel, the instrument panel, all panelling parts, the door seals, the handles and the seats removed by a workshop.

- When disposing of the vehicle, the safety instructions given for this must be observed. Take the vehicle to a recycling company for disposal.
- Persons weighing less than 35 kg should only travel on the rear seats. This does not apply to children who are travelling in child restraint systems with transponders ✱.
- In vehicles with seat occupancy recognition ✱, do not place any heavy objects on the front passenger seat otherwise the airbag systems for the front passenger seat may be triggered in the event of an accident.
- In vehicles with seat occupancy recognition ✱, to prevent malfunctions do not use protective covers or seat cushions on the front passenger seat.

- In order to prevent malfunctions when using a Vauxhall child restraint system with transponders ✱ on the front passenger seat, no objects (e.g. plastic sheet, stickers or heated mats) may be placed under the child restraint system.

Warning

Child restraint systems as well as other objects must never be carried on the lap of passengers; risk of fatal injury. If carried in this way, child restraint systems with transponders ✱ in vehicles with seat occupancy recognition ✱ could lead to front passenger airbag systems not being triggered in the event of an accident.



17118 T

Use of child restraint systems ✱ on the front passenger seat in vehicles with airbag systems, but without seat occupancy recognition ✱

Warning

No child restraint system ✱ may be installed on front passenger seat. Danger to life.

Versions with front passenger airbag can be identified by the word **AIRBAG** over the glove compartment and the warning sticker on the side of the instrument panel, visible when the passenger door is open - see Fig. 17118 A.

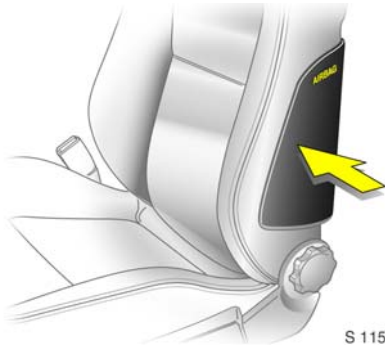

S 11549

Version with side airbag system * is indicated by **AIRBAG** text on outer side of front seat backrests.

Seat occupancy recognition *, see page 99.



17116 T



Use of child restraint systems * on front passenger seat in vehicles with airbag systems and seat occupancy recognition *



⚠ Warning

Only Vauxhall child restraint systems with transponders * can be fitted on the front passenger seats. Use of systems without transponders poses a risk of fatal injury.

Vehicles with seat occupancy recognition are identified by a sticker on the lower panel of the front passenger seat, see Fig. 17116 T.



Vehicles with seat occupancy recognition can also be identified by control indicator  in the instrument panel. If control indicator  illuminates for approx. 4 seconds when the ignition is switched on, the vehicle is equipped with seat occupancy recognition see page 99.

The seat occupancy recognition system detects Vauxhall child restraint systems with transponders  and deactivates the front and side airbag systems  for the front passenger seat. The curtain airbag system  remains activated. For seat occupancy recognition see page 99.



Vauxhall child restraint systems with transponders  are marked with a sticker or sew-on badge, see Fig. 17424 T.

Rollover protection system

The Astra TwinTop is equipped with rollover protection with reinforced windscreen frame and anti-roll bars behind the rear seat head restraints. Depending on the variant, the anti-roll bars are either fixed or deploy automatically in the event of an impact of a certain severity. The subsequent description only regards the variant with automatically deployed anti-roll bars .

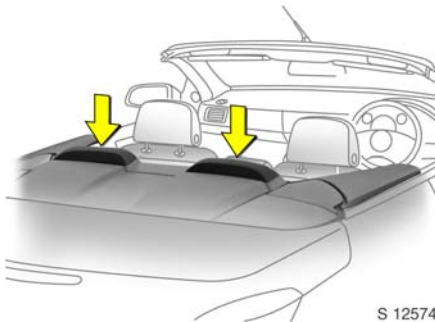

S 12574

In the event of a rollover, the anti-roll bars deploy upwards in a matter of milliseconds. They also deploy together with the front and side airbag systems ✱, helping to optimise occupant protection.

The system deploys with the roof open or closed. If the anti-roll bars are extended the roof must not be operated, see instructions in the following columns.



17105 T

Control indicator ✱ for extending anti-roll bars

The deployable anti-roll bars are monitored electronically together with the belt tensioners and the airbag systems. Their operational readiness is indicated by control indicator ✱ in the instrument panel. When the ignition is switched on, the control indicator illuminates for approx. 4 seconds. If it does not illuminate, does not go out after 4 seconds or illuminates whilst driving, there is a fault in or deployment of the anti-roll bars, belt tensioners and airbag systems - see page 87. The systems may fail to trigger in the event of an accident.

Actuation of the anti-roll bars is indicated by continuous illumination of ✱.

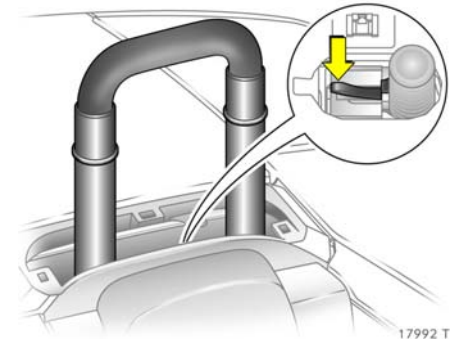

17992 T

Extended anti-roll bars

can be retracted (e.g. in order to close the roof after a collision).

Press the lever between the rods of an anti-roll bar to unlock the system. Push the anti-roll bar all the way down until it engaged. Fit the cover.

Repeat the procedure on the other anti-roll bar.

Control indicator ✱, however, will remain illuminated and the anti-roll bars will not deploy in the event of another collision.



Have the cause of the fault eliminated immediately by a workshop.

 **Warning**

The roof cannot be closed or opened if the anti-roll bars are extended. The anti-roll bars must first be retracted.

After deployment of the anti-roll bar, have the system repaired by a workshop immediately.

Manually retracted anti-roll bars will not deploy in the event of a collision.

Note

- Do not place any objects on the covers of the anti-roll bars behind the head restraints. They would be propelled through the vehicle in an uncontrolled fashion should the anti-roll bars deploy. Such objects could also prevent the anti-roll bars from extending.
- Do not operate the roof while the anti-roll bars are extended. Parts of the roof could be damaged during such operation.

- Deployment of the anti-roll bars is indicated by illumination of control indicator .
- If an attempt is made to operate the roof while the anti-roll bars are extended, a continuous signal will sound as a warning.

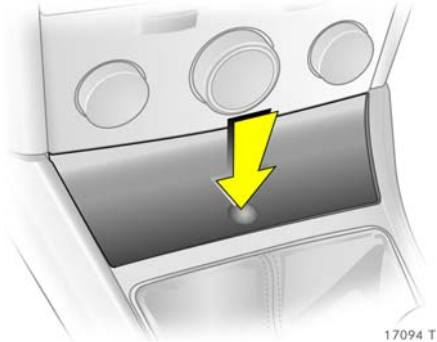

Cigarette lighter *

The cigarette lighter is in the front centre console, beneath the ashtray cover.

The ashtray cover opens when pressed at the point indicated.

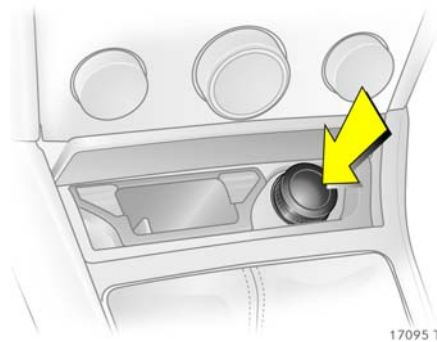

Press in cigarette lighter. Switches off automatically once the element is glowing. Pull out lighter.

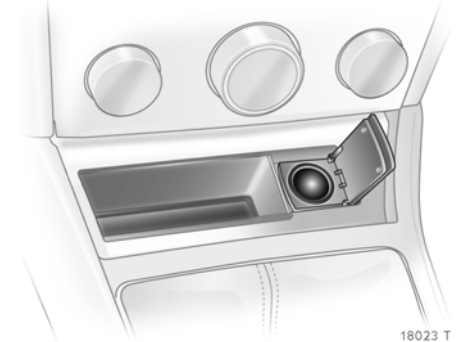

Accessory socket *

Some vehicles have an accessory socket for the connection of electrical accessories instead of a cigarette lighter. Use of the accessory socket while the engine is not running will discharge the battery.



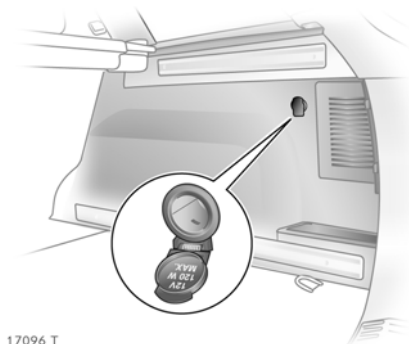

17096 T

Estates have an additional accessory socket * in the luggage compartment.

Do not damage the sockets by using unsuitable plugs.

The maximum power consumption of electrical accessories must not exceed 120 watts.

Do not connect any current-delivering accessories, e.g. electrical charging devices or batteries.

Electrical accessories connected to the socket must comply with the electromagnetic compatibility requirements laid down in DIN VDE 40 839, otherwise vehicle malfunctions may occur.

If the tyre repair set * is in operation, no consumers may be connected to the auxiliary socket.



17094 T

Ashtray *

To be used only for ash and not for combustible rubbish.

Warning

Failure to observe these descriptions can lead to injuries which may be fatal. Vehicle passengers should be informed accordingly.

Front ashtray

The ashtray is in the front centre console beneath a cover.

The cover opens when pressed at the point indicated.

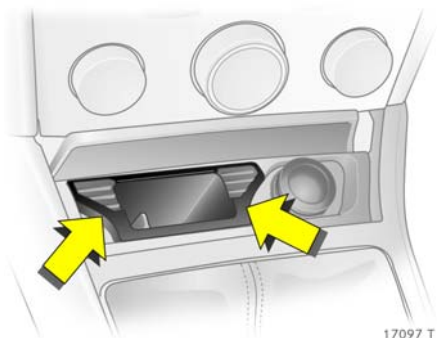

To empty, grip both sides of the ashtray insert at the spots illustrated and pull upwards.

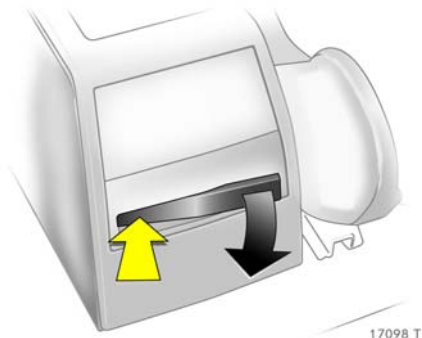

Rear ashtray *

The ashtray is in the rear centre console. Pull out the ashtray by pushing on one of the sides.



To empty, open the ashtray, press the spring (arrow) and pull the ashtray straight out rearwards.

Foldaway tables *

on the front seat backrests.

Open by pulling upward until it engages.

Fold away by pressing down past the resistance point.

Do not place any heavy objects on the table.

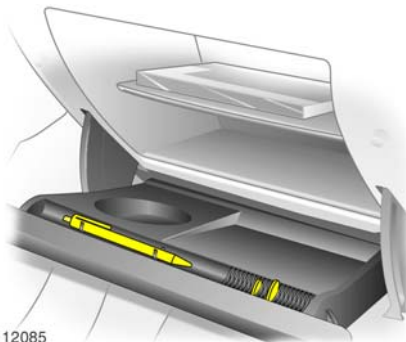

S 12085

Stowage compartments

Glove compartment

To open, pull handle upwards.

The glove compartment shelf * can be removed: Disengage the shelf by pulling on the front edge.

Refit the shelf by sliding it into the side guide strips and engage it in the rear panel by pushing.

The front of the open cover houses a pen holder and a coin compartment.

The glove compartment should be closed while driving.

Cooled glove compartment *, see page 156.

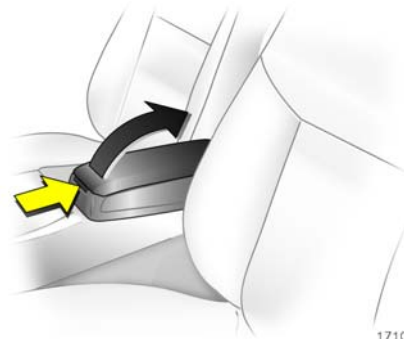

17103 T

Stowage compartment in front armrest *

To open, press button and open upper part of armrest.

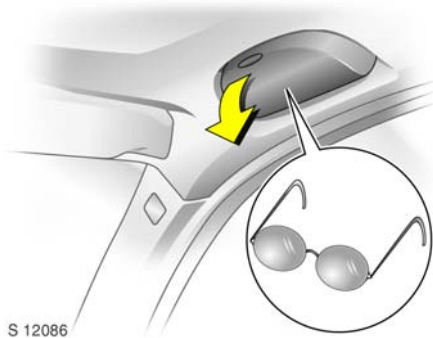

S 12086

Stowage compartment for glasses *

On driver's side: fold down to open.

Do not store heavy objects in the stowage compartment.

Cargo box *

See page 81.

Sun visors

Use the sun visor to protect from glare by pulling it down and swivelling it to the side *.

The covers of the mirrors in the sun visors should be closed while driving.

On vehicles with panoramic windscreen *, close the sun visors before moving the roof lining.

Instruments, controls

Control indicators 112
 Instrument display 119
 Information display 122
 Warning buzzers 140
 Windscreen wiper 141



18444 T

Control indicators

The control indicators described here are not present in all vehicles. The description applies to all instrument versions.

The control indicator colours mean:

- Red Danger, important reminder
- Yellow Warning, note, fault
- Green On confirmation
- Blue On confirmation



Open&Start system *

Control indicator illuminates or flashes yellow.

If it flashes

System has not detected electronic key in vehicle interior. The reasons for this may be:

- The electronic key is in the wrong location in the vehicle interior (do not put key in luggage compartment or in front of information display), or the electronic key is not in the vehicle interior, or influence from an external interference source (radio masts, interfering transmitters in the vicinity).
or
- Electronic key failure, for emergency operation, see page 37.

If the battery in the electronic key needs changing, **InSP3** appears in the service display or, in vehicles with check control *, by an appropriate message in the information display - see pages 39, 120.

Illuminates

Fault in Open&Start system.

Lock or unlock vehicle using remote control or emergency key if necessary, see page 43, or attempt to use the spare key.

Emergency operation, see page 44.

If  illuminates, this can also mean that the steering column lock is still locked: move steering wheel to and fro a little and press Start/Stop button again.

If  illuminates whilst driving a system error has occurred that may eventually lead to a complete failure.

If  illuminates or flashes: The Start/Stop button must be held depressed somewhat longer to switch off the ignition. It is possible that the vehicle will not start during the next start attempt.

If these flash continuously or if  illuminates, contact a workshop immediately.

**Engine oil pressure**

Control indicator illuminates red.

It illuminates when the ignition is switched on and goes out shortly after the engine starts.

Illuminates when the engine is running
Engine lubrication may be interrupted. This may result in damage to the engine and/or locking of the drive wheels:

1. Move out of the flow of traffic as quickly as possible without impeding other vehicles.
2. Depress clutch.
3. Shift manual transmission or Easytronic * into neutral; for automatic transmission *, set selector lever to **N**.
4. Switch off ignition.

 **Warning**

When the engine is off, considerably more force is needed to brake and steer.

Do not remove key until vehicle has come to a standstill, otherwise the steering column lock could engage unexpectedly.

Contact a workshop for assistance.



Brake system, clutch system

Control indicator illuminates or flashes red.

It illuminates after the ignition is turned on, when the handbrake is applied or if the brake or clutch fluid level is too low. For further information see pages 222, 302.

For vehicles with Easytronic ✱, the control indicator flashes for a few seconds when the ignition is turned off if the handbrake is not applied.

Warning

If it illuminates when the handbrake is released: stop vehicle immediately. Contact a workshop for assistance.



Airbag systems ✱, belt tensioners ✱, deployable anti-roll bars ✱

Control indicator illuminates red.

Illuminates when the engine is running
Fault in airbag system, belt tensioners or extending anti-roll bars, see pages 87, 98, 104



Electronic Stability Programme (ESP®^{Plus}) ✱

Control indicator flashes or illuminates yellow.

Flashing during driving

System actively engaged, see pages 210, 210, 239.

Illuminates while driving

System switched off or fault in system for Electronic Stability Programme, see page 210.



Seat belt ✱

Control indicator illuminates or flashes red.

Illuminates when the ignition is turned on, until the seat belt is fastened. After starting to drive, the control indicator flashes.

Fasten seat belt, see page 88.

**Doors and luggage compartment open**

Control indicator illuminates red.

It is illuminated when a door or the luggage compartment is open.

**Alternator**

Control indicator illuminates red.

It illuminates when the ignition is switched on and goes out shortly after the engine starts.

Illuminates when the engine is running

Stop, switch off engine. Battery is not charging. Cooling may be faulty. For diesel engines, the effect of the brake servo may be lost. Contact a workshop immediately.

**Coolant temperature**

Control indicator illuminates red.

Illuminates when the engine is running

Stop and switch off engine. Coolant temperature too high: Risk of engine damage. Check coolant level immediately – see page 300.

**Engine electronics, transmission electronics *, immobiliser, diesel fuel filter ***

Control indicator illuminates or flashes yellow.

It illuminates for a few seconds when the ignition is switched on.

Illuminates when the engine is running

Fault in engine or gearbox electronic system. Electronics have switched to emergency running programme fuel consumption may be increased and the vehicle's driveability reduced, see page 206. Contact a workshop immediately.

Illuminated together with InSP4 in the service display: Have the diesel fuel filter drained of water – see page 300.

Flashes when the ignition is on

Fault in the electronic immobiliser system; the engine cannot be started, see page 31.

**Easytronic *, start engine**

Control indicator illuminates yellow.

It illuminates if the footbrake is not operated. The indicator goes off as soon as the footbrake is operated. The engine can only be started with the footbrake operated, see page 182.

IDS+**Interactive Driving System *, Continuous Damping Control (CDC) *, SPORT mode ***

Control indicator illuminates yellow.

It illuminates for a few seconds when the ignition is switched on.

Illuminates while driving

Fault in system. Contact a workshop immediately.

IDS+ – see page 209,
CDC – see page 211,
SPORT mode – see page 212.



18444 T



Engine oil level ✱

Control indicator illuminates yellow.

The engine oil level is checked¹⁾ automatically.

Illuminates when the engine is running

Engine oil level too low. Check engine oil level and top up engine oil if necessary, see page 298.



Exterior lights

Control indicator illuminates green.

It is illuminated when the exterior lights are on – see page 143.



Parking distance sensor ✱

Control indicator illuminates yellow.

Fault in system. Contact a workshop immediately.

Parking distance sensor, see page 215.



Turn signal lights

Control indicator flashes green.

Control indicator flashes at the side concerned.

Both control indicators flash with the hazard warning lights on.

Fast flashing: failure of a turn signal light or associated fuse, failure of turn signal light on trailer ✱.

Change bulbs, see page 269. Fuses, see page 262.



Fuel level

Control indicator illuminates or flashes yellow.

Illuminates

Low fuel level, fuel gauge in reserve area.

Flashing

Fuel supply exhausted, refuel immediately.

Never let the tank run dry!

Erratic fuel supply can cause catalytic converter to overheat, see page 204.

Diesel engines: If the tank is run dry, bleed the fuel system as described on page 241.

¹⁾ Not on Z 14 XEP or Z 20 LEH engine. Sales designation – see page 310.

**Fog lights ***

Control indicator illuminates green.

It is illuminated when the fog lights are on – see page 145.

**Main beam**

Control indicator illuminates blue.

It is illuminated when main beam is on and during headlight flash – see pages 11, 144.

**Fog tail light**

Control indicator illuminates yellow.

It is illuminated when the fog tail lights are on – see page 145.

**Winter programme of automatic transmission * or Easytronic ***

Control indicator illuminates in gear display with Winter programme engaged.

Further information, see pages 180, 186, 193.

**SPORT mode of automatic transmission * or Easytronic ***

Control indicator illuminates in gear display with Sport programme engaged.

Further information, see pages 179, 185, 192.

**Seat occupancy recognition ***

Control indicator illuminates or flashes in odometer display.

Illuminates

Seat occupancy recognition has detected a child restraint system with transponders. Airbag systems for the passenger are deactivated, see page 99.

If it flashes

Fault in system or child seats with transponder incorrectly fitted, see page 99.

**Exhaust emission ***

Control indicator illuminates or flashes yellow.

It illuminates when the ignition is switched on and goes out shortly after the engine starts.

Illuminates when the engine is running

Fault in emission control system. The permitted emissions may be exceeded. Contact a workshop immediately.

If it flashes when the engine is running:

Fault which could lead to damage to the catalytic converter, see page 206. Contact a workshop immediately.

**Anti-lock Brake System (ABS) ***

Control indicator illuminates red.

Illuminates while driving

Fault in anti-lock brake system, see page 224.



18444 T



Preheating system ✱, diesel particle filter ✱

Control indicator illuminates or flashes yellow.

Illuminates

Preheating system active, switches on only if outside temperature is low.

Flashing

(on vehicles with diesel particle filter)

The driving situation is such that the diesel particle filter self-cleaning function can not operate automatically. You may continue to drive the vehicle normally. The vehicle will not be damaged and does not require service.

The self-cleaning function will automatically operate while driving after the engine has reached its normal operating temperature. The control indicator  will continue to flash until the self-cleaning operation is complete. This may take up to 20 minutes of driving. The time will be shorter at higher vehicle speeds.

Further information, see page 207.



Deflation detection system ✱, tyre pressure monitoring system ✱

Control indicator illuminates red
Tyre pressure loss – see page 218.

Control indicator illuminates yellow
Fault in system, see pages 218, 219.
Contact a workshop for assistance.



Adaptive Forward Lighting ✱ (AFL)

Control indicator flashes yellow.

Flashing

Fault in system. Contact a workshop immediately.

Flashes for 4 seconds when ignition switched on

System converted for driving abroad.

AFL, see page 147.



Cruise control ✱

Control indicator illuminates green.

It is illuminated when the system is on – see page 213.



17021 T

Instrument display

On some versions, the pointer of the tachometer, speedometer and fuel gauge briefly moves to its end position when the ignition is switched on.

Tachometer

Indicates engine speed.

Warning zone: Maximum permissible engine speed exceeded; danger to engine.

Speedometer Speed display.



17023 T

Fuel gauge

Pointer in left zone or illuminated = Reserve area

Pointer in right zone or flashing = Refuelling, see page 202

Never run the tank dry!

Diesel engines: If the tank is run dry, bleed the fuel system as described on page 241.

Because of the fuel remaining in the tank, the amount of fuel required to fill the tank may be less than the specified tank capacity.



Odometer display

Top line:

Trip odometer or clock display *

To switch between the trip odometer and the clock display *, press reset button briefly, see page 119.

Trip odometer

Display of miles covered since reset.

To reset, hold reset button down for around one second with the ignition turned on, see page 119.

If the clock display is activated, first switch to trip odometer.

Time display *

To adjust the time, setting button in instrument panel:

Press for approx. 2 seconds:

Hours flash

Press briefly

Set hours

Press for approx. 2 seconds

Minutes flash

Press briefly

Set minutes

Press for approx. 2 seconds

Clock is started.

Bottom line:

Odometer

Records the miles counted.



Service Display

InSP Service interval display. Shows distance remaining to next service. Further notes, see page 296.

InSP2 Faulty bulb *, see page 269.

InSP3 Battery voltage of remote control or electronic key in Open&Start system low *, see pages 34, 39.

InSP4 Drain water from diesel fuel filter *. Contact a workshop for assistance.

On vehicles with check control *, an appropriate message is shown on the info display instead of **InSP2** and **InSP3**.

ESPoff Electronic Stability Programme * off, see page 210.

ESPon Electronic Stability Programme * on, see page 210.



Transmission display *

Display of gear selected in automatic transmissions * or current gear or mode for Easytronic *:

- P** Part position on automatic transmission
- R** Reverse gear
- N** Neutral
- A** Automatic mode on Easytronic
- M** Manual mode on Easytronic
- D** Automatic mode on automatic transmission
- 1 - 4** Current gear on automatic transmission
- 1 - 5** Manual mode, current gear for
- 1 - 6 *** Easytronic

For Easytronic *, the display flashes for a few seconds if **A**, **M** or **R** is selected when the engine is running but the footbrake is not depressed.



Information display

Triple information display

Display of time, outside temperature and date/infotainment system (when it is on).

When the ignition is off, the time, date and outside temperature can be presented for 15 seconds by briefly pressing one of the two buttons below the display.

F in the display indicates a fault. Have the cause eliminated by a workshop.



Board information display *

Display of time, outside temperature and date/infotainment system (when it is on).

F in the display indicates a fault. Have the cause eliminated by a workshop.

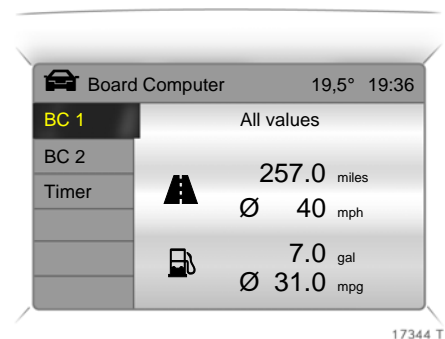

Graphical information display *, colour information display *

Display of time, outside temperature, date/infotainment system (when it is on) and climate control system *.

The graphical information display presents the information in monochrome. The colour information display presents the information in colour.

The type of information and how it is displayed depends on the equipment of the vehicle and the settings of the Infotainment system *, the trip computer * and the climate control system *.

Some information appears in the display in an abbreviated form.

Infotainment system, see Infotainment system instructions. Climate control system, see page 168.

F in the display indicates a fault. Have the cause eliminated by a workshop.



Outside temperature

A fall in temperature is indicated immediately and a rise in temperature after a time delay.

If outside temperature drops to 3 °C, the symbol * illuminates in the triple information display or the board information display * as a warning for icy road surfaces. * remains illuminated until temperatures reach at least 5 °C.



In vehicles with graphical information display * or colour information display *, a warning message appears the display as a warning for icy road surfaces. There is no message below -5 °C.

Warning

Caution: The road surface may already be icy even though the display indicates a few degrees above 0 °C.

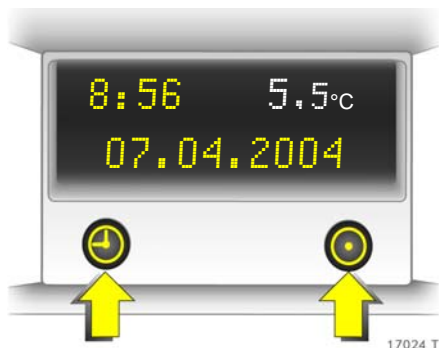

Triple information display

Set date and time

Infotainment system off: press and below the display as follows:

Press for approx. 2 seconds:

Day flashes

: Set day

: Month flashes

: Set month

: Year flashes

: Set year

: Hours flash

: Set hours

: Minutes flash

: Set minutes

: Clock is started.

Correcting time *

Some RDS transmitters do not send a correct time signal. If the incorrect time is continually displayed, switch off automatic time synchronisation * and set the time manually - see next column.

The automatic setting is indicated by in the display.

Deactivating/activating automatic time synchronisation: infotainment system off, press and below the display:

Hold down for approx. 2 sec., clock display is now in setting mode.

Press twice (until year flashes).

Press and hold down for approx. 3 seconds until flashes in display * and "RDS TIME" appears (years flash during this time).

Press , indication on display:
RDS TIME 0 = off.

Press , indication on display:
RDS TIME 1 = on.

Press three times.

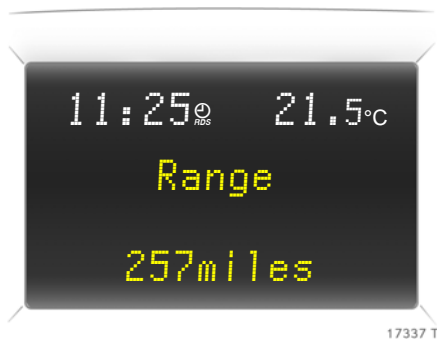

17337 T

Board information display *, selecting functions

Functions and settings of some equipment * can be accessed via the board information display.

This is done using the menus and buttons of the Infotainment System * or with the left adjuster wheel * on the steering wheel. The corresponding menu options then appear in the next line of the display.

If warning messages from Check-control * are shown, the display is blocked for other information. Confirm the warning message. If there are several warning messages, confirm these in succession.

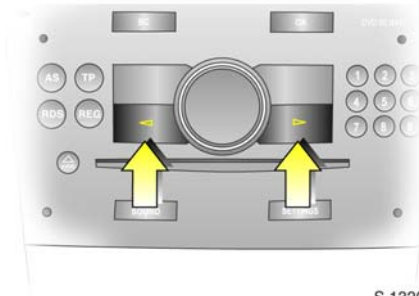

S 13209

Selection with arrow keys

Select the menu points using the buttons on the Infotainment system

OK button

Select marked point, confirm command.



17014 T

Select using the left adjuster wheel * on the steering wheel

Turn up

Previous menu point.

Turn down

Next menu point.

Press

Select marking, confirm commands.

System settings – see page 131.

Trip computer – see page 128.



17337 T

Board information display *, system settings

Press the **Settings** button of the infotainment system. Menu item **Audio** or **System** will appear.

Press left arrow key to access menu point **System**. Select menu point **System**. The first function of the menu **System** is shown.

Some information appears in the display in an abbreviated form.

The functions are displayed in the following order:

- Time synchronisation
- Time, setting hours
- Time, setting minutes
- Date, setting day
- Date, setting month
- Date, setting year
- Ignition logic
- Language selection
- Setting units of measure

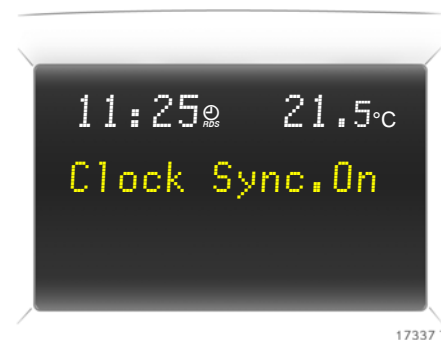

17337 T

Correcting time *

Some RDS transmitters do not send correct time signals. If the incorrect time is displayed often, deactivate automatic time synchronisation * and set the time manually.

The automatic setting is indicated by  in the display.

To correct time with the help of RDS, select the menu item for time synchronisation from the **Settings** menu.

Make the desired setting.

Setting date and time

Select the menu item for time and date setting from the **Settings** menu.

Make the desired setting.

The setting is saved when the menu item is exited.

Ignition logic *

Adjustment, see Infotainment system instructions.



Language selection

You can select the display language for some functions.

Select the menu item for language from the **Settings** menu and make the desired setting.

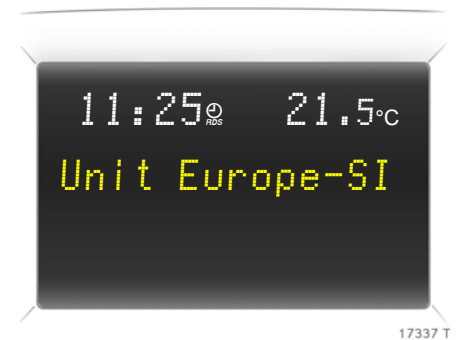

Setting units of measure

You can select which units of measure are to be used.

Select the menu item for units of measure from the **Settings** menu and confirm the desired setting.

Board information display *, trip computer *

The trip computer provides information on driving data, which is continually recorded and evaluated electronically.

Access trip computer vehicle data by pressing the **BC** button on the infotainment system or the left adjuster wheel * on the steering wheel.

Some information appears in the display in an abbreviated form.

Once an audio function has been selected, the subsequent rows of the trip computer function are displayed.

The functions are displayed in the following order:

- Instantaneous consumption
- Average consumption
- Effective consumption
- Average speed
- Distance travelled
- Range
- Stop watch



Instantaneous consumption

Display changes depending on speed:

Display in gal/h Below 8 mph (13 km/h)

Display in mpg Above 8 mph (13 km/h)

Average consumption

Average consumption display. The measurement can be reset to zero and restarted at any time, see "Resetting trip computer information to zero".

Effective consumption

Used fuel quantity display. The measurement can be reset to zero and restarted at any time, see "Resetting trip computer information to zero".

Average speed

Average speed display. The measurement can be reset to zero and restarted at any time, see "Resetting trip computer information to zero".

Stoppages in the journey with the ignition off are not included in the calculations.

Distance travelled

Driven mileage display. The measurement can be reset to zero and restarted at any time, see "Resetting trip computer information to zero".

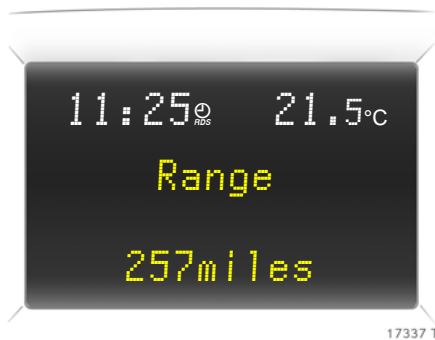

Range

Range is calculated from current fuel tank content and instantaneous consumption. The display shows average values.

After refuelling, the vehicle updates the range automatically after a brief delay.

If less than 30 miles (50 km) can be driven with the fuel remaining in the tank, the warning "Range" appears on the display.

If less than 20 miles (30 km) can be driven with the fuel remaining in the tank, the warning "Refuel!" * appears on the display.

Acknowledge the menu item as described on page 130.

Resetting trip computer information to zero (reset)

The following trip computer information can be reset (reset and restart measurements or calculations):

- Average consumption
- Effective consumption
- Average speed
- Distance travelled.

Select the desired trip computer information.

Reset by pressing the left adjuster wheel * on the steering wheel or the OK button on the Infotainment system.



Stop watch

Select function, operate with arrow keys:

- Select Start menu item using left arrow key, start/stop by pressing OK.
- Select Reset menu item using right arrow key, reset by pressing OK.

Operate using left adjuster wheel * on steering wheel:

- Press: start/stop.

Interruption of power supply

If the power supply has been interrupted or if the battery voltage has dropped too low, the values stored in the trip computer will be lost.

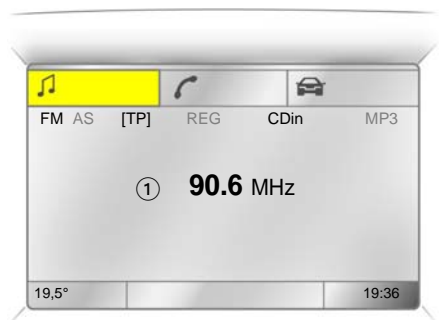

17331 T

Graphical information display * or colour information display *, selecting functions

The functions and settings of some equipment * can be accessed via the graphical information display or the colour information display.

These functions are marked on the menu on the display or performed using the arrow keys * on the Infotainment system, the multi-function button * on the Infotainment system or with the left adjuster wheel * on the steering wheel.

If warning messages from Check-control * are shown, the display is blocked for other information. Confirm the warning message. If there are several warning messages, confirm these in succession.

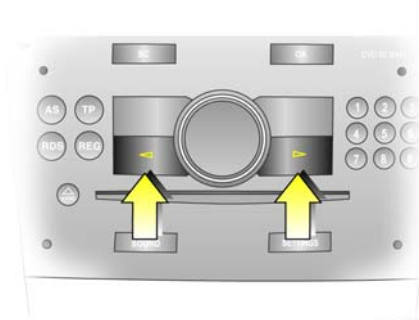

S 13209

Selection with arrow keys

Select menu options via menus and the keys on the Infotainment system.

OK button

Select marked point, confirm command.

To exit a menu, press the right or left arrow key to access **Return** or **Main**.



17013 T

To select using the multi-function button

Turn

Mark menu options or commands, select function ranges,

Press

Select marking, confirm commands.

To exit a menu, turn the multi-function button left or right to **Return** or **Main** and select.



17014 T

Select using left adjuster wheel * on steering wheel

Turn up

previous menu point.

Turn down

next menu point.

Press

Select marking, confirm commands.

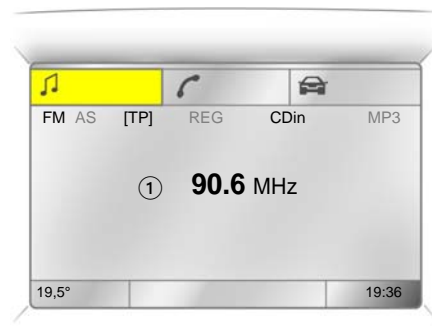

17331 T

Function ranges

For each functional area there is a main page (Main), which is selected at the top edge of the display (not with the Infotainment system CD 30 or the Mobile Phone Portal):

- Audio
- Navigation *
- Telephone *
- Trip computer *.

For Audio, Navigation * and Telephone * functions – see infotainment system instructions.

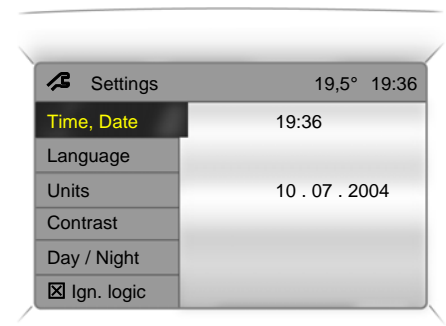

17332 T

System settings

The settings are accessed via the **Settings** menu.

Press the **Main** button * (not found on all infotainment systems) on the infotainment system (call up main display).

Press the **Settings** button of the infotainment system. On Infotainment System CD 30, make sure no menu has been selected.

The **Settings** menu is displayed.

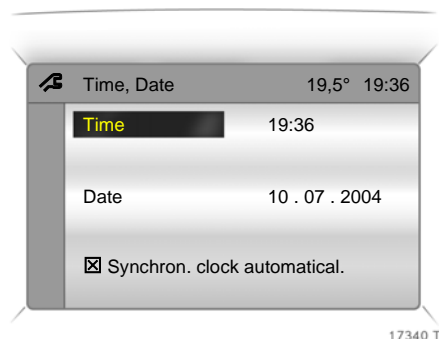

Setting the date and time ✱

Select menu item **Time, Date** from the **Settings** menu.

The menu for **Time, Date** is displayed.

Select the menu items required:

Make the desired setting.

Correcting time ✱

In systems with GPS receiver¹⁾, date and time are set automatically upon receipt of a GPS satellite signal. If the displayed time does not match local time, it can be corrected manually or automatically by receiving an RDS time signal²⁾ ✱.

Some RDS transmitters do not send correct time signals. If the incorrect time is displayed often, deactivate automatic time synchronisation ✱ and set the time manually.

To correct time with the help of RDS, select menu item **Synchron. clock automatical.** from the **Time, Date** menu.

The box in front of **Synchron. clock automatical.** will be ticked; see Fig. 17340 T.



Language selection

You can select the display language for some functions.

Select menu item **Language** from the **Settings** menu.

The available languages are displayed.

¹⁾ **GPS** = **G**lobal **P**ositioning **S**ystem, satellite system for world-wide positioning.

²⁾ **RDS** = **R**adio **D**ata **S**ystem.



Select the desired language.

Selections are indicated by a ► in front of the menu item.

In systems with voice output ✱, when the language setting of the display is changed the system will ask whether the announcement language should also be changed – see Infotainment system instructions.



Setting units of measure

You can select which units of measure are to be used.

Select menu item **Units** from the **Settings** menu.

The available units are displayed.

Select the desired unit.

Selections are indicated by a ● in front of the menu item.

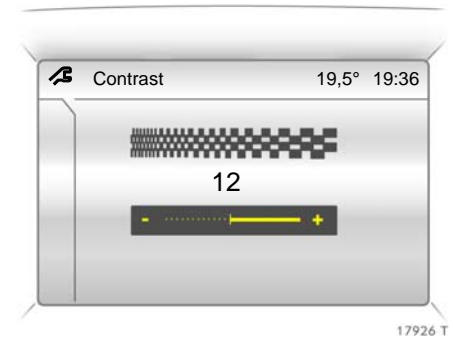

Adjusting contrast ✱

(graphical information display)

Select menu item **Contrast** from the **Settings** menu.

The menu for **Contrast** is displayed.

Confirm the required setting.

Setting display mode *

The display can be adjusted to suit the light conditions, black or coloured text on a light background or white or coloured text on a dark background.

Select menu item **Day / Night** from the **Settings** menu.

The options are displayed.

Automatic: adapted based on vehicle lighting.

Always day design: black or coloured text on light background.

Always night design: white or coloured text on dark background.

Selections are indicated by a ● in front of the menu item.

Ignition logic *

Adjustment, see Infotainment system instructions.

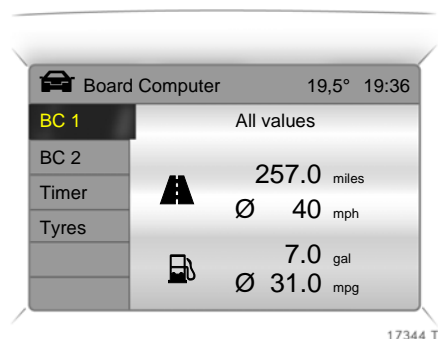
**Graphical information display * or colour information display *, trip computer ***

The trip computers provide information on driving data, which is continually recorded and evaluated electronically.

The trip computer main menu (Main) provides information about range, average consumption * and current consumption.

To display other trip computer data, press the **BC** button on the infotainment system *, select the trip computer menu front the display or press the left adjuster wheel * on the steering wheel.

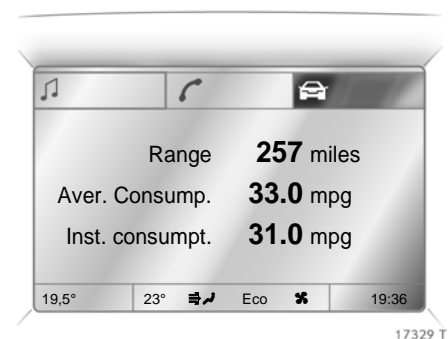
**Range**

Range is calculated from current fuel tank content and instantaneous consumption. The display shows average values.

After refuelling, the vehicle updates the range automatically after a brief delay.

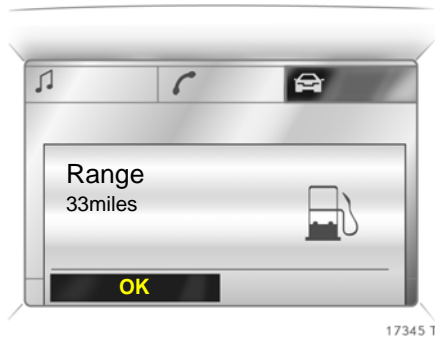

17345 T

If the fuel in the tank will allow less than 30 miles (50 km) of travel, the warning "Range" appears on the display.

If less than 20 miles (30 km) can be driven with the fuel remaining in the tank, the warning "Please refuel!" * appears on the display.

Acknowledge the menu item as described on page 130.

Instantaneous consumption

Display changes depending on speed:

Display in gal/h	Below 8 mph (13 km/h)
Display in mpg	Above 8 mph (13 km/h)

Distance travelled

Driven mileage display. The measurement can be reset to zero and restarted at any time, see "Resetting trip computer information to zero".

Average speed

Average speed calculation. The measurement can be reset to zero and restarted at any time, see "Resetting trip computer information to zero".

Stoppages in the journey with the ignition off are not included in the calculations.

Effective consumption

Used fuel quantity display. The measurement can be reset to zero and restarted at any time, see "Resetting trip computer information to zero".

Average consumption

Average consumption calculation. The measurement can be reset to zero and restarted at any time, see "Resetting trip computer information to zero".

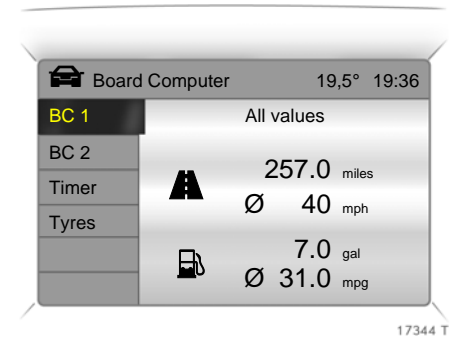

17344 T

Resetting trip computer information to zero (reset)

The following trip computer information can be reset (restart measurements):

- Distance
- Average speed
- Effective consumption
- Average consumption.

Select **BC 1** or **BC 2** from the trip computer menu.

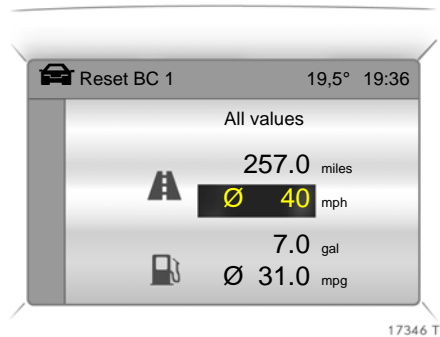

The information of the two trip computers can be reset separately, making it possible to evaluate data from different time periods.

Select the desired trip computer information.

The value for the selected function will be reset and recalculated.

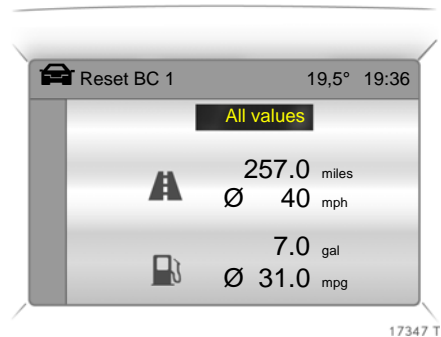

To reset all information of a trip computer, select menu item **All values**.

After resetting, "- - -" is displayed for the trip computer information selected. The recalculated values are displayed after a brief delay.

Interruption of power supply

If the power supply has been interrupted or if the battery voltage has dropped too low, the values stored in the trip computer will be lost.

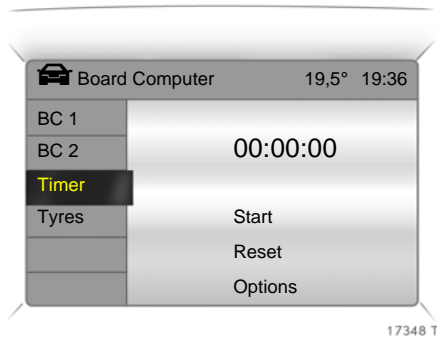

Stop watch

Select menu item **Timer** from the **Board Computer** menu.

The **Timer** menu is displayed.

To start, select menu item **Start**.

To reset, select menu item **Reset**.

The desired stop watch display can be selected from the **Options** menu *:

Driving Time excl. Stops

The time the vehicle is in motion is recorded. Stationary time is not included.

Driving Time incl. Stops

The time the vehicle is in motion is recorded. The time the vehicle is stationary with the key in the starter switch is included.

Travel Time

Measurement of the time from manual activation via **Start** to manual deactivation via **Reset**.

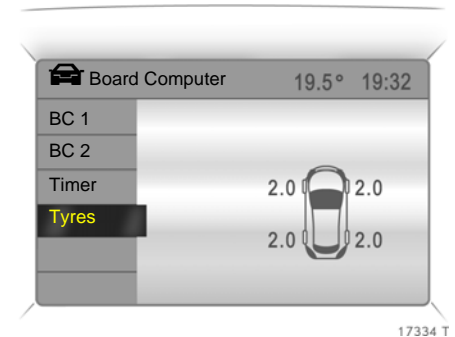

Display of current tyre pressure *

Select menu item **Tyres** from the **Board Computer** menu.

The current pressure of each tyre is displayed.

Further information, see page 219.

Check control *

Check control monitors some fluid levels, the tyre pressure *, battery of the remote control, the anti-theft warning system *, the brake light switch and important exterior lights, including cable and fuses. In trailer mode, the trailer lighting is monitored.

Warning messages appear on the display. If there are several warning messages, they are displayed one after the other.

Some of the warning messages appear on the display in an abbreviated form.

Examples of warning messages for the graphical information display * and colour information display * are depicted. On the board information display, messages appear in an abbreviated form.

Acknowledge warning messages as described on pages 125, 130. Unacknowledged warning messages can be re-displayed later.

Warning messages:

Remote Control Battery check

Battery voltage of remote control or electronic key in Open&Start system too low *, see page 34.

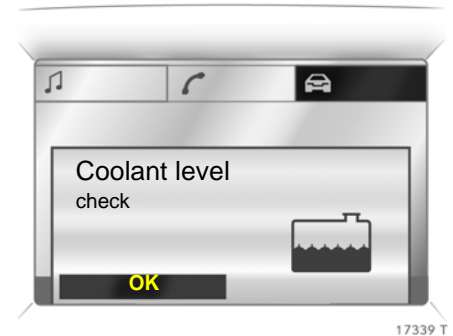

Brake light switch check

Fault. Brake light does not come on during braking. Have the cause of the fault eliminated immediately by a workshop.

Safeguard check

Fault. System fault in Vauxhall alarm system. Have the cause of the fault eliminated immediately by a workshop.

If there is a fault in the vehicle lighting, the respective fault source is displayed as text, e.g.:

**Brake light
check right**

In vehicles with tyre pressure monitoring system ✱, if tyre pressure is too low, the display indicates which tyre to check, e.g.:

**Tyre pressure
check rear
right
(value in bar)**

Check tyre pressure at next opportunity using suitable gauge. Tyre pressure monitoring system ✱, see page 219. Checking tyre pressure, see page 337.

In vehicles with tyre pressure control system ✱, if there is major loss of pressure in a tyre, the display indicates the tyre at fault, e.g.:

**Attention!
Rear left tyre
pressure loss
(value in bar)**

Stop immediately and check tyres and tyre pressures. Tyre pressure monitoring system ✱ see page 219.

**Wash
Fluid Level
check**

Fluid level in windscreen wash system too low. Topping up wash fluid, see page 305.

Rear window wash system and headlight wash system ✱ are deactivated if wash fluid level is low.

**Coolant level
check**

Fluid level in engine cooling system is low. Check coolant level immediately – see page 300.

Interruption of power supply

Stored warning messages appear on the display one after the other.

Warning buzzers

When starting the engine or whilst driving:

- If the electronic key of the Open&Start system * is not present or is not recognised.
- If seat belt * is not fastened.
- If a door or the tailgate is ajar when the vehicle starts off.
- Once you have reached a certain speed * if the handbrake is applied.
- If a specified maximum speed * is exceeded.
- With Easytronic * - if **A**, **M** or **R** is selected while the engine is running and the driver's door is opened but the footbrake is not depressed.

When the vehicle is parked and the driver's door is opened:

- When the key is in the starter switch *.
- With parking lights or dipped beam on.
- With Open&Start system * and automatic transmission if the selector lever is not in **P**.
- With Easytronic *, if the handbrake is not applied and no gear is engaged when the engine is off

Indicator and warning buzzers for Astra TwinTop *:

- Indicator buzzer upon completed opening or closing of the convertible hardtop.
- Indicator buzzer upon completed raising or lowering of the electric luggage compartment loading aid.
- Gong tone if the boot lid is not closed during roof operation.
- Gong tone if the boot lid is not fully opening during operation of the luggage compartment loading aid.
- Gong tone during roof operation if vehicle speed exceeds 20 mph (30 km/h).
- Gong tone when vehicle speed exceeds 20 mph (30 km/h) if the roof is not fully open or closed.
- Three gong tones during roof or loading aid operation if the luggage compartment blind is not attached.
- Three gong tones during roof operation if outside temperature is below -20 °C, vehicle battery voltage is too low or the system is overloaded.

- Continuous warning buzzer during roof operation if the anti-roll bars * have been triggered.
- Continuous warning buzzer starting one minute before the end of the 9-minute stand-by time with the roof in an intermediate position.
- Continuous warning buzzer starting one minute before the end of the 9-minute stand-by time with the loading aid in a raised position.
- Persistent warning buzzer when closing the luggage compartment lid, if the lowering process of the electric load aid is not complete or has been interrupted.

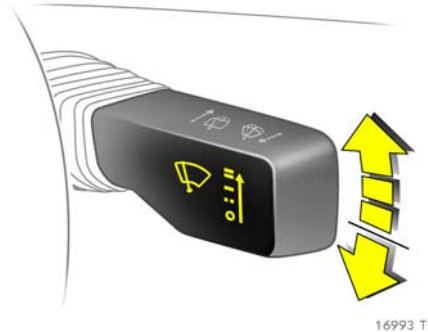

16993 T

Windscreen wiper

To activate, move stalk up lightly.

- = Off
- = Timed interval wipe
- = Slow
- ≡ = Fast

The stalk always moves back to starting position. Shift to next higher or lower level: move stalk slightly.

Move stalk past resistance point and hold: the windscreen wiper stages are run through; an acoustic signal sounds at position ○.

Move stalk down from position ○: Single swipe.

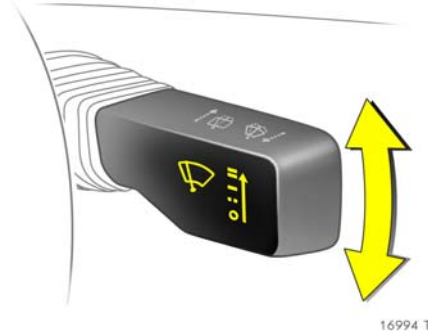

16994 T

Adjustable timed interval wipe *

Adjust wiper interval to a value between 2 and 15 seconds: switch ignition on, move stalk downwards from position ○, wait for required interval time and move stalk to interval wiping --.

The interval time selected remains stored until it is next changed or until the ignition is turned off.

After turning on the ignition and setting the stalk to --, the interval is set to 6 seconds.

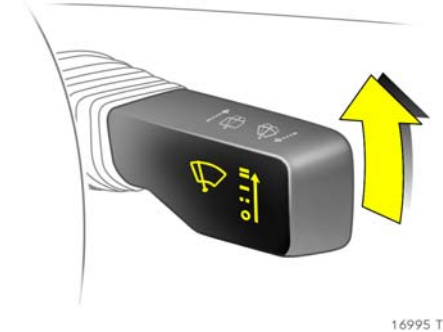

16995 T

Automatic wiping with rain sensor *

To activate, move stalk up lightly.

- = Automatic wiping with rain sensor
- = Off

The rain sensor detects the amount of water on the screen and automatically controls the wiper.

Keep the rain sensor detection field clear by activating the screen wash system.

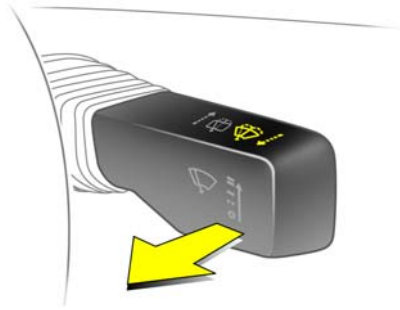

16996 T

Empty windscreen wash system and headlight wash system *

To activate, pull stalk toward steering wheel.

The wiper swipes for a few strokes. At low speeds, there is a single post-wash swipe.

The headlight wash system * is ready for operation when the headlights are switched on. Wash fluid is sprayed onto the headlights once. Then the headlight wash system is disabled for 2 minutes.

On vehicles fitted with rain sensor *, keep the sensor area clean.

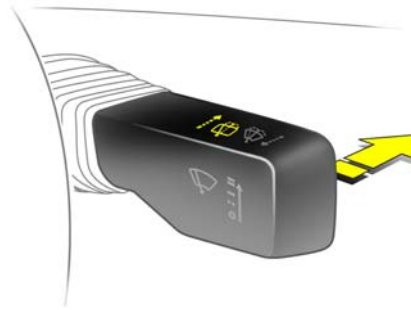

16997 T

Rear screen wiper and wash system

To activate, push stalk forward lightly.

The rear screen wiper swipes in timed interval mode.

To deactivate, push stalk forward lightly again.

If the stalk is held forwards, the rear screen wash system is activated.

Lighting

Exterior lights	143
Main beam, headlight flash	144
Automatic dipped beam activation *.....	144
Turn signal lights	144
Fog lights \mathcal{D} *.....	145
Fog tail light \mathcal{D}	145
Reverse lights	145
Hazard warning lights.....	146
Headlight range adjustment \mathcal{D}	146
Adaptive Forward Lighting * (AFL) ..	147
Door-to-door light function*.....	148
Instrument illumination, information display illumination.....	148
Courtesy light	148
Battery discharge protection.....	150
Light covers.....	150
Headlights when driving abroad	150

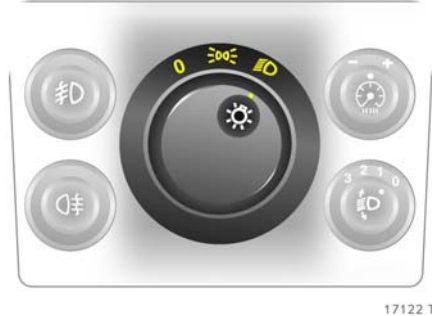

Exterior lights

Turn light switch:

- 0** = Off
- \mathcal{D} = Parking lights
- \mathcal{D} = Dipped beam or main beam

In positions \mathcal{D} and \mathcal{D} , the tail lights and number plate lights are also on.

Control indicator \mathcal{D} , see page 116.

If the ignition is switched off with the dipped beam or main beam on, the parking lights illuminate.

Versions with daytime running lights *: Parking lights are on when the ignition is switched on and the light switch is set to **0** or **AUTO**. Dipped beam is on when the engine is running.

The daytime running lights switch off when the ignition is switched off.

Follow the regulations of the country in which you are driving when using daytime running lights and fog lights *.

Driving abroad, see page 150.

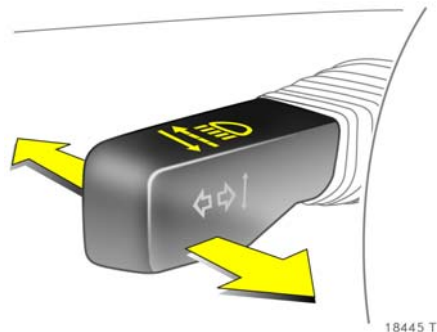

18445 T

Main beam, headlight flash

To switch from dipped beam to main beam, push stalk forward.

To switch back to dipped beam, push stalk forward again or pull toward steering wheel.

To activate the headlight flash, pull stalk toward steering wheel. Main beam is engaged for the duration of activation.

The blue control indicator  is illuminated when main beam or headlight flash is on.

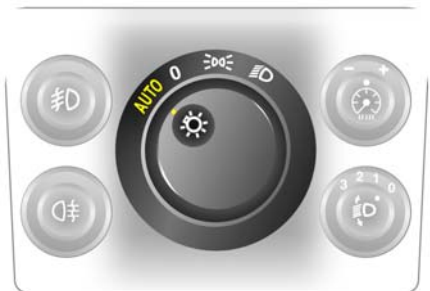

17123 T

Automatic dipped beam activation *

Light switch to **AUTO**: Dipped beam switches itself on or off automatically when the engine is running, depending on the external lighting conditions.

The exterior lights switch off when the ignition is switched off.

For reasons of safety, the light switch should always remain in the **AUTO** position.

Move light switch to  if visibility is poor because of fog, for example.

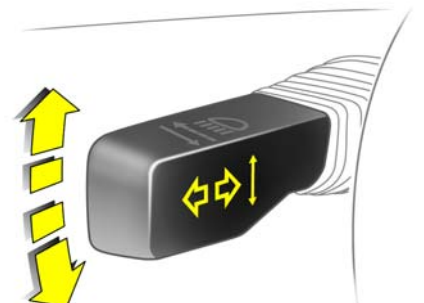

16989 T

Turn signal lights

To activate, move stalk up or down lightly.

- Stalk up = Right turn signal lights
- Stalk down = Left turn signal lights

After operation, the turn signal stalk returns to its starting position.

If the stalk is moved past the resistance point, the turn signal light remains on. When the steering wheel moves back toward the straight-ahead position, the turn signal light is automatically deactivated.

Tap signal: Move stalk to resistance point and release to activate three flashes from the turn signals when changing lanes or the like.

Move the stalk to the resistance point and hold for the turn signals to flash longer.

Switch the turn signal off manually by moving the stalk slightly.



17124 T

Fog lights D^*

The fog lights can only be switched on when both the ignition and lights are on.

- On = Press D^* , D^* illuminates in instrument panel
- Off = Press D^* again or turn off ignition or light off

Fog tail light $\text{D}^{\#}$

The fog tail light can only be switched on both the ignition and dipped beam/parking lights are on.

- On = Press $\text{D}^{\#}$, $\text{D}^{\#}$ illuminates in instrument panel
- Off = Press $\text{D}^{\#}$ again or turn off ignition or light off

The vehicle fog tail light are deactivated when towing.



Reverse lights

Come on when reverse gear is engaged and ignition is switched on.



16991 T

Hazard warning lights

To switch on, press button , to switch off, press button  again.

To aid location of the pushbutton, the red surface is illuminated when the ignition switched on. When the button is pressed, its control indicator flashes in time with the hazard warning lights.

The hazard warning lights switch on automatically when the airbags are triggered, and the central locking unlocks all doors. Switch off hazard warning lights with button .



17125 T

Headlight range adjustment

Manual headlight range adjustment *

With dipped beam switched on, adjust headlight range in four steps to suit vehicle load. Turn wheel against resistance and click it to the required position.

Correct adjustment of the headlight range reduces dazzle for other road users.

Automatic level control system , see page 217.

Vehicles without automatic level control system

- 0 = Front seats occupied
- 1 = All seats occupied
- 2 = All seats occupied and luggage compartment load
- 3 = Driver's seat occupied and luggage compartment load

Vehicles with automatic level control system

- 0 = Front seats occupied
- 1 = All seats occupied
- 1 = All seats occupied and luggage compartment load
- 2 = Driver's seat occupied and luggage compartment load

Automatic headlight range adjustment *

On vehicles with Xenon headlights, the range of the headlights is adjusted automatically based on vehicle load.

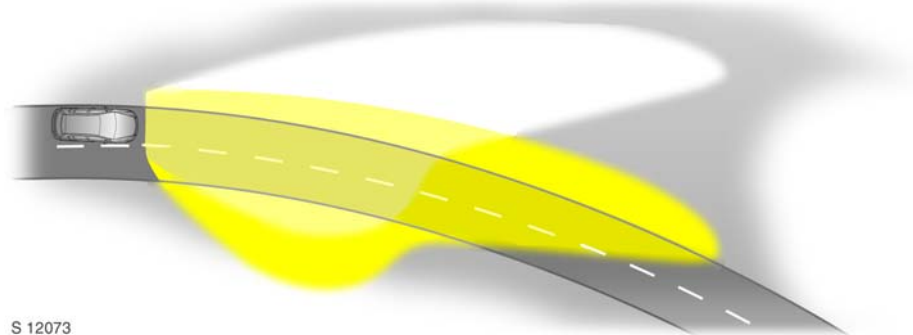

S 12073

Adaptive Forward Lighting * (AFL)

improves lighting in curves (curve lighting) on vehicles with Bi-Xenon headlight system.

Curve lighting

The Xenon light beam pivots based on steering wheel position and speed (from approx. 6 mph/10 km/h).

The headlights shine at an angle of up to 15° to the right or left of the direction of travel.

Motorway lighting

At higher speeds and continuous straight ahead travel, the dipped beam automatically raises slightly, thereby increasing headlight range.



17127 T

Control indicator for adaptive driving lights

Flashing: Fault in system. System not ready for operation.

If the cornering light swivelling device fails, the relevant dipped beam is switched off. The corresponding fog light is automatically switched on for reasons of safety.

Contact a workshop for assistance.

A flashing control indicator  for 4 seconds after the ignition is switched on is a reminder that the headlights have been adjusted, see "Headlights when driving abroad", page 150.

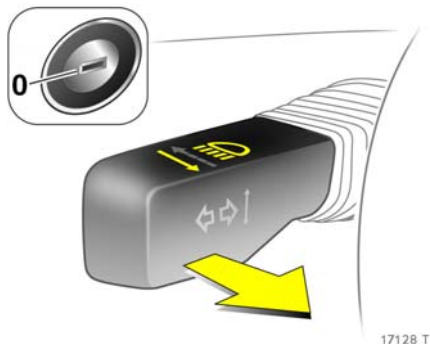

Door-to-door light function*

Dipped beam and reverse lights * illuminate for around 30 seconds after the driver exits the vehicle and closes his door.

To activate

1. Switch off ignition.
2. Remove ignition key *.
3. Open driver's door.
4. Pull turn signal stalk toward steering wheel.
5. Close driver's door.

If the driver's door is left open, the lights will go out after two minutes.

The light is switched off immediately by inserting the key into the ignition or pulling the turn signal stalk again with the driver's door open.



Instrument illumination, information display illumination

Comes on when ignition is switched on.

Brightness can be adjusted when the exterior lights are on: Push to release knob  and then turn it clockwise or anti-clockwise and hold until the desired brightness is obtained.

Display mode *, see page 134.

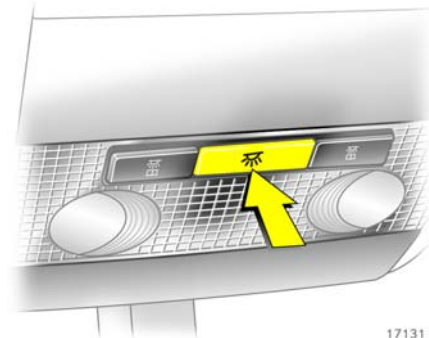

Courtesy light

Automatic interior light

Comes on automatically when the vehicle is unlocked with the remote control, when a door is opened or when the key is removed from the starter switch after the ignition is switched off.

Goes off automatically after a delay when the doors are closed or immediately when the ignition is switched on or the doors are locked.

Front courtesy light

To operate manually from inside when the doors are closed:

On = Press button 

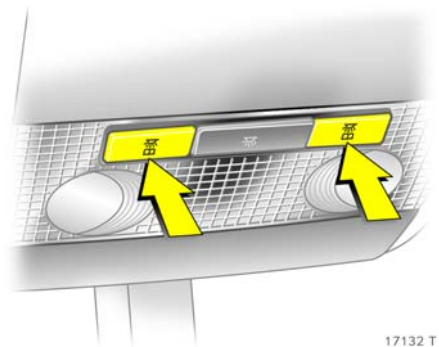

Off = Press button  again



17132 T

Front reading lights ✱

Left and right reading lights are individually operable. With ignition on:

- On = Press button 
- Off = Press button  again

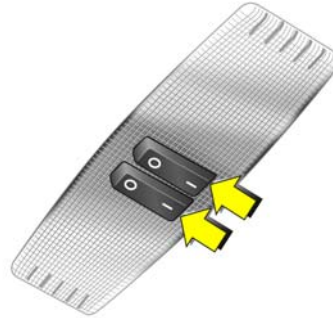

17133 T

Courtesy lights and rear reading lights ✱

Centre switch position: The rear courtesy light comes on together with the front one when a door is open.

The rear reading lights on the left and right can be switched on separately. With ignition on:

- On = Switch position I
- Off = Switch position 0

Entry lighting ✱

After unlocking the vehicle, the instrument and switch lighting come on for a few seconds.

Door handle lighting ✱

When the exterior lights are on, the interior front door handles are illuminated.

Illuminated mirror in the sun visors ✱

The lighting switches on when the cover is opened.

Glove compartment lighting

on when lid is open.

Cigarette lighter and ashtray illumination ✱

Comes on when ignition is switched on.

Luggage compartment lighting

Comes on when the boot lid/tailgate is opened.

Automatically regulated centre console lighting ✱

Spotlight in housing of interior mirror.

Daylight-dependent, automatically regulated centre console lighting with ignition switched on.

Battery discharge protection

To prevent the battery from becoming discharged, the courtesy light, reading lights, luggage compartment lighting and glove compartment lighting switch off automatically 10 minutes after the ignition is switched off.

Light covers

The inside of the light covers may mist up briefly in poor, wet and cold weather conditions, in heavy rain or after washing. The mist disappears quickly by itself; to help, switch on the lights.

Headlights when driving abroad

The asymmetrical dipped beam increases the field of vision on the passenger side of the lane.

This causes glare for oncoming traffic if the vehicle is driven in countries where traffic drives on the opposite side of the road.

Do as follows to prevent glare:

Vehicles with halogen headlight system or Xenon headlight system ✱

Have headlights adjusted in a workshop.

Vehicles with adaptive forward lighting ✱ (AFL)

1. Pull and hold stalk for main beam on steering wheel (headlight flash)
2. Switch on ignition.
3. After approx. 3 seconds, an acoustic signal sounds and then AFL control indicator  flashes approx. 4 seconds.

After the switch, AFL control indicator  flashes for 4 seconds each time the ignition is switched on.

To return to asymmetrical dipped beam, pull and hold the main beam stalk again, switch on the ignition and wait for the acoustic signal. AFL control indicator  will then discontinue flashing.

Control indicator , see pages 118, 147.

Infotainment system

Radio reception *	151
Infotainment system *	151
Remote control on steering wheel *..	151
Twin Audio *	152
AUX input *	152
Mobile telephones and radio equipment *	152

Radio reception *

Car radio reception differs from domestic radio reception:

As the vehicle antenna is relatively near the ground, the broadcasting companies cannot guarantee the same quality of reception as obtained with a domestic radio using an overhead antenna.

- Changes in distance from the transmitter,
 - multi-path reception due to reflection and
 - shadowing
- may cause hissing, noise, distortion or loss of reception altogether.

Infotainment system *

The infotainment system is operated as described in the operating instructions.

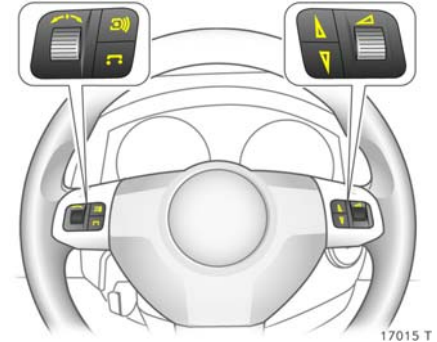

Remote control on steering wheel *

The functions of the Infotainment system * and the information display can be operated using the adjuster wheels and buttons on the steering wheel.

Further information – see pages 125, 131 and the relevant operating instructions.



17026 T

Twin Audio *

Twin Audio allows rear seat occupants the choice between the audio source played on the Infotainment system * or another audio source.

Only an audio source that is not currently active on the infotainment system can be controlled using Twin Audio.

Two headphone connections are available, with separate volume controls.

Further information is available in the infotainment system operating instructions.

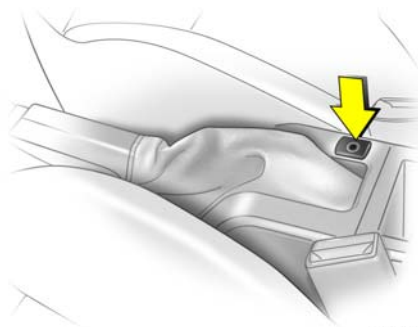

18505 T

AUX input *

The AUX input is in the centre console next to the handbrake.

An external audio source such as portable CD player can be connected using a 3.5 mm jack plug via the AUX input.

Keep AUX input clean and dry at all times.

Further information is available in the infotainment system operating instructions.

Mobile telephones and radio equipment *

The Vauxhall installation instructions and the operating guidelines provided by the telephone manufacturer must be observed when fitting and operating a mobile telephone. Failure to do so could invalidate the vehicle's operating permit (EU Directive 95/54/EG).

Recommended prerequisites for fault-free operation:

- Professionally installed exterior antenna to obtain the maximum range possible.
- Maximum transmission power 10 Watt.
- Installation of the telephone in a suitable spot (see information on page 106).

Obtain advice on predetermined installation locations for the external antenna and equipment holder and ways of using devices with transmission power of more than 10 Watts. We recommend that you consult your Vauxhall Authorised repairer, who will have brackets and various installation kits available as accessories and will install them in accordance with regulations.

A hands-free attachment without an external antenna in mobile phone standards GSM 900/1800/1900 and UMTS must only be operated if the maximum transmission power of the mobile phone does not exceed 2 Watts with GSM 900 and 1 Watt in other cases. The operating regulations stipulated by the manufacturer of the telephone and the hands-free attachment must be complied with.

For reasons of safety, we recommend that you do not use the phone while driving. Even use of a hands-free set can be a distraction while driving. Be sure to observe any country-specific regulations.

 **Warning**

Mobile phones and radio equipment may cause malfunctions in the vehicle electronics if they are operated in the vehicle without the external antenna unless the above-mentioned regulations are complied with.

Mobile phones that do not comply with the above-mentioned mobile phone standard and radio equipment must only be operated using an antenna that is attached to the exterior of the vehicle.

Climate control

Heating and ventilation system, air conditioning system *.....	154
Automatic air conditioning system *	155
Electronic climate control system *...	155
Air vents	156
Cooled glove compartment *.....	156
Heated rear window *, heated exterior mirrors *.....	157
Heated front seats *.....	157
Heating and ventilation system	158
Air conditioning system *.....	161
Automatic air conditioning system *	163
Electronic climate control system *...	168
Air intake.....	174
Pollen filter	174
Note	174
Maintenance	175



Heating and ventilation system, air conditioning system *

Ventilation, heating and cooling * are combined into one unit that is designed to provide comfort regardless of the season, weather or outside temperature.

When cooling * is activated, the air is cooled and dried.

The heating unit heats the air as required in all operating modes depending on the position of the temperature switch. The air supply can be adjusted to suit requirements by means of the fan.



The buttons for cooling ❄️ and air recirculation ↻ are only found on versions with optional air conditioning system *.

Air conditioning system * - see pages 161, 163.



Automatic air conditioning system ✳

Provides a comfortable interior regardless of the weather, outside temperature or season.

When an interior temperature is set with the temperature control, the temperature and amount of inflowing air are automatically regulated. A uniform, comfortable climate in the vehicle is thereby automatically obtained based on outside climate conditions.

Automatic air conditioning system - see page 163.



Electronic climate control system ✳

Offers the greatest comfort in the vehicle interior regardless of the conditions outside.

To ensure a uniform and comfortable climate in the vehicle, the temperature of inflowing air, air-flow rate and air distribution are automatically adapted based on the climate conditions outside the vehicle and the current temperature of the vehicle interior.

The set values appear on the information display.

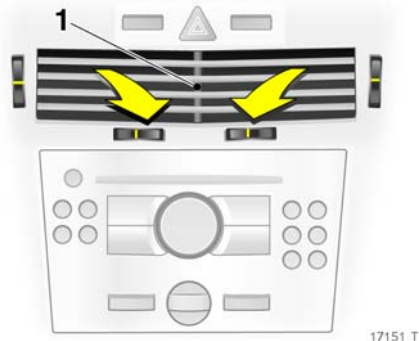

Electronic climate control system, see page 168.



17151 T

Air vents

The interior ventilation can be adjusted to a comfortable level by adjusting the temperature switch.

To increase the air supply, turn the fan all the way up and set the air distribution switch to  or .

Centre and side air vents (1)

Open nozzle: move vertical knurled wheel downwards.

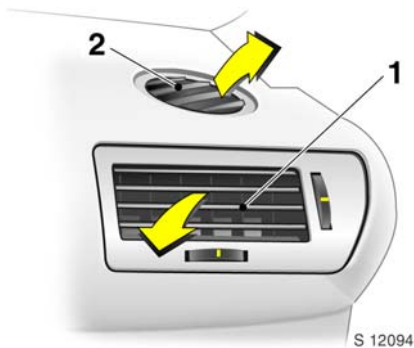

Adjust air flow direction by rotating the horizontal knurled wheel.



S 12094

To close the vent, turn the vertical adjuster wheel fully up. The symbol  appears. The slats of the vent remain open although the air supply is closed.

Windscreen defroster nozzles (2)

Air distribution switch to  or : Air flows onto windscreen and side windows.

Additional vents

below the windscreen and door windows and in the front footwell.

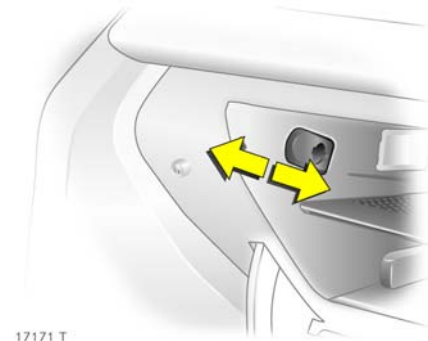

17171 T

Cooled glove compartment *

Cooled air is fed into the glove compartment through a nozzle.

If glove compartment cooling is not required, slide the slider forward.



Heated rear window *, heated exterior mirrors *

With the ignition on, the rear screen and exterior mirror heating is switched on by pressing button :

LED in  button illuminated: rear window and exterior mirror heating.

LED in  button not illuminated: rear window and exterior mirror heating is switched off.

Heating takes place with the engine running and is switched off automatically after several minutes.

Astra TwinTop: The heated rear window and heated exterior mirrors * are deactivated when the roof is open.

The heated rear window automatically switches on when the diesel particle filter is being cleaned * depending on the engine.

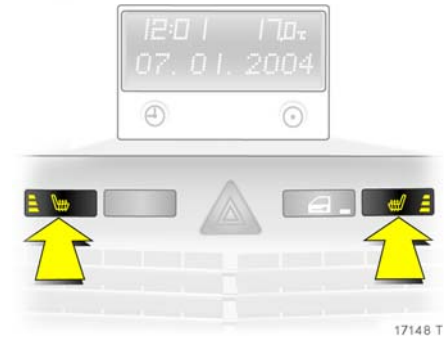

Heated front seats *

Two buttons above the centre air vents for left and right seat.

Operation with ignition switched on:

Press button  one or more times to set the desired heat output. The control indicator in the button indicates which of the three heating levels is active.

We do not recommend prolonged use of the highest level for people with sensitive skin.

To switch off: Press button  repeatedly until the control indicator in the button goes out.



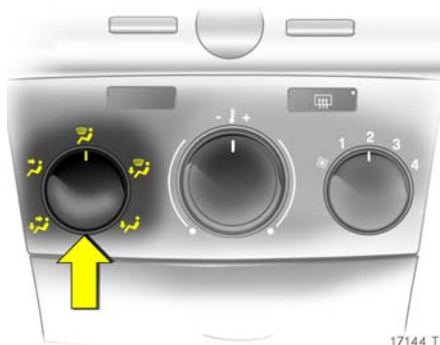

Seat heating is operational when the engine is running.





Heating and ventilation system

Air distribution

Adjust with left rotary switch.

-  To head area via adjustable vents, to footwell
-  To head area via adjustable vents
-  To windscreen and front door windows
-  To windscreen and front door windows, to footwell
-  To footwell

Intermediate settings are possible.

Open the air vents when the switch is set to  or .



Temperature

Adjust with centre rotary switch.

- Red area = Warm
- Blue area = Cold

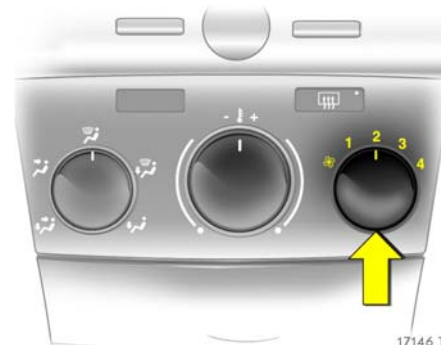

Air flow

Adjust with right rotary switch.



Four fan speeds:

-  Switched off
- 1-4** Selected fan speed

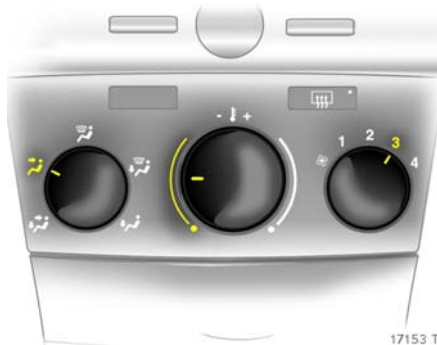
The rate of air flow is determined by the fan. The fan should therefore also be switched on during a journey.



Ventilation

- For maximum ventilation in head area: set air distribution switch to  and open all vents.
- For ventilation to footwell: Set air distribution switch to .
- For simultaneous ventilation to the head area and the footwell: set air distribution switch to .
- Set the temperature to the desired setting.
- Switch fan on, adjust as required.

Heating

The amount of heat is dependent on the coolant temperature and is thus not fully attained until the engine is warm.



For rapid warming of the passenger compartment:

- Set air distribution switch to desired position, preferably position , see page 158.
- Turn the temperature switch clockwise as far as it will go (warm).
- Set the fan to speed **3**.
- Open air vents.

Vehicles with Quickheat : depending on the outside temperature and the engine temperature the passenger compartment is heated up more quickly using an auxiliary electric heater.

The auxiliary electric heater switches itself on automatically.

The comfort and general well-being of the vehicle occupants are to a large extent dependent on a suitable ventilation and heating setting.

To achieve a stratification of temperature with the pleasant effect of "cool head and warm feet", turn the rotary switch for air distribution to  or , set temperature rotary switch to any position (in the mid-range with stratification of temperature).



Heating the footwell

- Set air distribution switch to .
- Move temperature switch to red zone.
- Switch on fan.





Window demisting and de-icing

Warning

Failure to follow the instructions could lead to misted or icy windows and accidents stemming from impaired visibility.

Misted or icy windows, e. g. due to damp weather, damp clothing or low outside temperatures:

- Move air distribution switch to .
- For simultaneous footwell heating, set air distribution switch to .

- Turn the temperature switch clockwise as far as it will go (warm).
- Set fan switch to 3 or 4.
- Activate heated rear window .
- Open side air vents as required and direct them towards the side windows.

Air conditioning system *

As a supplement to the heating and ventilation system, the air conditioning system cools and dehumidifies (dries) inflowing air.

If cooling or dehumidification is not desired, switch off cooling in order to save fuel.

Cooling switches off automatically at low outside temperatures.

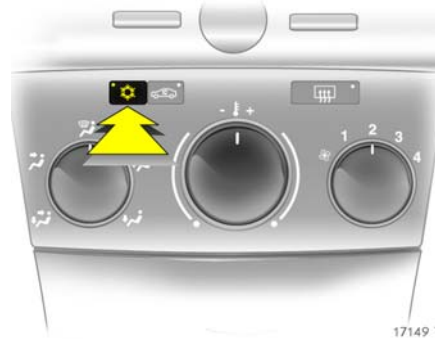

Cooling ☀

Operate only with the engine on and the fan running:

On = Press ☀

Off = Press ☀ again

Control indicator in the button.



Air recirculation system ↻

The recirculation switch ↻ is used to set the ventilation system to recirculation mode (control indicator in switch).

If fumes or unpleasant odours penetrate from outside: temporarily switch on air recirculation system ↻.





To increase the cooling power at high outside temperatures, temporarily switch on the air recirculation system.

The air recirculation system minimises the entry of outside air. The humidity increases, and the windows can mist up. The quality of the passenger compartment air deteriorates which may cause the vehicle occupants to feel drowsy.

Air distribution to : the air recirculation system is automatically switched off to speed up window demisting and prevent fogging.



Comfort setting



- Set cooling  as desired.
- Air recirculation system  off.
- Set air distribution switch to  or .
- Set temperature switch as desired.
- Switch on fan at desired speed.
- Open or adjust air vents as required.

Temperature switch in centre of adjustment range: warmer air will flow into the footwell and cooler air into the upper zone, with warmer air coming from the side air vents and cooler air from the centre vents.



Maximum cooling

Open windows and sunroof  briefly so that warm air can escape rapidly.

- Cooling  on.
- Air recirculation system  on.
- Set air distribution switch to .
- Turn the temperature switch anti-clockwise as far as it will go (cold).
- Set fan switch to 4.
- Open all air vents.





Window demisting and de-icing

Warning

Failure to follow the instructions could lead to misted or icy windows and accidents stemming from impaired visibility.

Misted or icy windows, e.g. due to damp weather, damp clothing or low outside temperatures:

- Cooling  on, the AC compressor switches off automatically at low exterior temperatures (icing).
- Move air distribution switch to .
- Turn the temperature switch clockwise.
- Set fan switch to 4.
- Open side air vents as required and direct them towards door windows.
- Switch on heated rear window .

Automatic air conditioning system

Provides a uniformly comfortable interior regardless of the weather, outside temperature or season.

To ensure a constant and comfortable climate in the vehicle, the temperature of the inflowing air and the air-flow rate are changed automatically based on climate conditions outside the vehicle.

Temperature changes due to external influences, such as direct sunlight, are automatically compensated.



Automatic mode

Basic setting for maximum comfort:

- Set fan switch to **A**
- Set air distribution switch to desired position - see next column
- Use rotary switch to set temperature to 22 °C (a higher or lower temperature can be set as desired)
- Air conditioning compressor activation, see page 165
- open all air vents.

Deactivation of the air conditioning compressor can reduce the level of comfort and safety - see page 165.

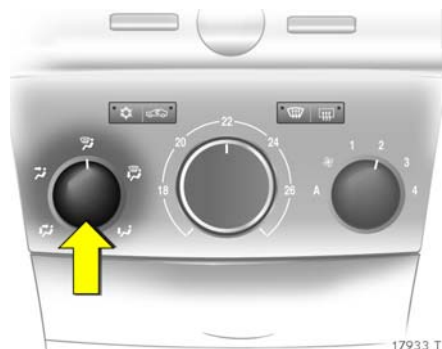

Air distribution

Adjust with left rotary switch.

- To head area via adjustable vents, to footwell
- To head area via adjustable vents
- To windscreen and front door windows
- To windscreen and front door windows, to footwell
- To footwell

Intermediate settings are possible.

Open the air vents when the switch is set to ➤ or ➤.

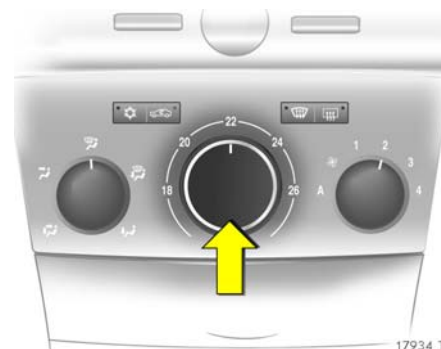

Temperature preset

Adjust with centre rotary switch.

Set the rotary switch to a value between 17 °C and 27 °C. Intermediate settings are possible.

The selected temperature is maintained.

For reasons of comfort, temperature can only be changed in small increments.

There is no temperature control for settings below 17 °C (all the way left) or above 27 °C (all the way right). The air conditioning system works at maximum cooling or heating.



Air flow

Adjust with right rotary switch.

- 1 - 4** Manual fan speed setting, intermediate settings are possible
- A** Automatic fan speed setting
- ✱** Fan switched off

Fan speed is regulated to provide the rate of air flow necessary to maintain the pre-selected temperature.



Select automatic mode for the highest level of comfort.

When the fan is off, the air conditioning compressor is also off.



To activate/deactivate air conditioning compressor (cooling)

Operate only with the engine on and the fan running:

- On = Press 
- Off = Press  again

Control indicator in the button.

When cooling (AC compressor) is active, air is cooled and dehumidified. If cooling or dehumidification is not desired, switch off cooling in order to save fuel.

Cooling switches off automatically at low outside temperatures.



Manual air recirculation mode

The air recirculation system prevents the entry of outside air and the air in the passenger compartment is circulated.



Press button , control indicator in button.

The exchange of fresh air is reduced in air recirculation mode. The quality of the passenger compartment air deteriorates which may cause the vehicle occupants to feel drowsy. In operation without cooling the air humidity increases, so the windows may mist up. Consequently, manual air recirculation should only be run for short periods of time.

To deactivate manual air recirculation: Press button  again. The control indicator in the button will go out.



Ventilation

- For maximum ventilation in head area: set air distribution switch to  and open all vents.
- For ventilation to footwell: Set air distribution switch to .
- For simultaneous ventilation to the head area and the footwell: set air distribution switch to .
- Set desired temperature.
- Set fan switch to **A**. The fan can also be manually set: Set the rotary switch to position **1 - 4**. Intermediate settings are also possible.

Heating

The amount of heat is dependent on the coolant temperature and is thus not fully attained until the engine is warm.



For rapid warming of the passenger compartment:

- Set the air distribution switch to the desired position, see page 158.
- Set the centre rotary switch to the desired temperature. We recommend a value of about 22 °C.
- Set fan switch to **A**. The fan can also be manually set: Set the rotary switch to position **1 - 4**. Intermediate settings are also possible.

Vehicles with Quickheat : depending on the outside temperature and the engine temperature the passenger compartment is heated up more quickly using an auxiliary electric heater.

The auxiliary electric heater switches itself on automatically.

The comfort and general well-being of the vehicle occupants are to a large extent dependent on a suitable ventilation and heating setting.

To obtain a stratification of temperature in the vehicle with the pleasant effect "cool head and warm feet", set the air distribution switch to  or , set the temperature switch to about 22 °C and open the centre air vents.



Maximum cooling for very hot interior

Open windows and sunroof briefly so that warm air can escape rapidly.

- Cooling on.
- Set air distribution switch to .
- Set the temperature switch to the desired temperature.
- Set fan switch to **A**.
- Open all air vents.

The automatic climate control system provides maximum cooling down to the set value.

At settings below 17 °C (rotary switch all the way to the left), the system continually runs with maximum cooling. When the air conditioning compressor is running, air recirculation is switched on automatically.



Window demisting and de-icing

Warning

Failure to follow the instructions could lead to misted or icy windows and accidents stemming from impaired visibility.

Misted or icy windows, e. g. due to damp weather, damp clothing or low outside temperatures:

- Cooling on.
- Press button : In switch position **A**, the fan automatically switches to the highest speed and air is directed to the windscreen.

- Set temperature to maximum heating, i.e. turn the centre rotary switch all the way to the right (28 °C).

- Switch on heated rear window .

Operation with cooling (air conditioning compressor) is not possible when outside temperatures are low.

To switch off, press button again; the automatic air conditioning system will operate at the settings selected previously.

Electronic climate control system *

Provides a the greatest amount of comfort in the interior regardless of the weather, outside temperature or season.

To ensure a constant and comfortable climate in the vehicle, the temperature of the inflowing air, the air-flow rate and the air distribution are changed automatically according to climatic conditions outside the vehicle.

Temperature changes due to external influences, such as direct sunlight, are automatically compensated.

Data is shown on the information display. Setting modifications are briefly shown in the information display, superimposing over the currently displayed menu.

The display can vary according to the type of presentation, see page 122.

The settings in the climate control system are stored in the vehicle key when the vehicle is locked, see "Store personal settings in vehicle key", see page 32.



Different settings are stored for each remote control. Use of a remote control will activate the settings associated with it.

Manual settings e.g. operating without cooling and air distribution can be selected using the menu, see page 170.

When cooling (air conditioning compressor) is active, air is cooled and dehumidified.

The pollen filter removes dust, soot, pollen and spores from the inflowing outside air.



The automatic air recirculation system * has an air quality sensor to detect harmful ambient gases, in which case it will switch automatically to recirculation.

When set to automatic mode, the climate control system provides the optimal settings for almost all conditions. If necessary, climate control system settings can be modified manually.

The climate control system is only operational when the engine is running.

Cooling (air conditioning compressor) switches off automatically at low outside temperatures.



Automatic mode

Basic setting for maximum comfort:

- Press **AUTO** button.
- Open all air vents.
- Air conditioning compressor activation, see page 171.
- Preset temperature to 22 °C using left rotary switch.

The temperature can be set higher or lower as desired.

Switching off the AC compressor (**Eco** appears in display) can reduce comfort and affect safety, see page 171.

All air vents are actuated automatically in automatic mode. The air vents should therefore always be open, see page 156.

Automatic air recirculation mode *

The ventilation system is set to recirculation mode and interior air is recirculated.

The automatic air recirculation system has an air quality sensor to detect harmful gases in the outside air, in which case it will switch automatically to recirculation.

If outside temperatures are low and cooling (air conditioning compressor) is switched off, automatic air recirculation is only available in a limited capacity so as to prevent the windows from misting. Activate recirculation manually if so desired.

Switching automatic recirculation on or off, see page 173.

Manual recirculation mode, see page 173.

Temperature preset

The left rotary switch can be used to set temperatures between 16 °C and 28 °C.

For reasons of comfort, temperature can only be changed in small increments.

Vehicles with Quickheat ❄️: depending on the outside temperature and the engine temperature the passenger compartment is heated up more quickly using an auxiliary electric heater.

The auxiliary electric heater switches itself on automatically.

If a temperature below 16 °C is set, **Lo** appears in the display: the climate control system runs constantly at maximum cooling power. The temperature is not regulated.

If a temperature above 28 °C is set, **Hi** appears in the display: the climate control system runs constantly at maximum heating power. The temperature is not regulated.

The temperature settings are saved when the ignition is switched off.

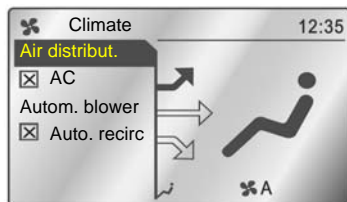

17161 T

Manual settings

Under certain circumstances (e.g. iced or misted windows), the functions of the climate control system can be modified manually.

Climate control system settings can be changed via the centre switch, the buttons and the menus depicted on the display.

Press the centre switch to call up the menu. The menu for manual climate control system settings appears in the display.

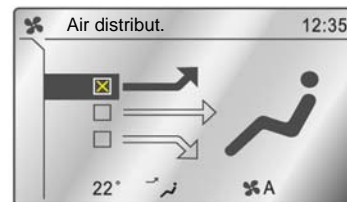

17162 T

Individual menu items are marked by turning the centre switch and selected by pressing it. Selecting certain menus by pressing the rotary switch will open a submenu ❄️.

To exit a menu, turn the centre switch left or right to **Return** or **Main** and select.

Manual settings are saved when the ignition is switched off.





18496 T

Window demisting and de-icing

Warning

Failure to follow the instructions could lead to misted or icy windows and accidents stemming from impaired visibility.

Misted or icy windows, e.g. due to damp weather, damp clothing or low outside temperatures:

Press  button,  appears in display: control indicator in button illuminates.

The temperature and the air distribution are adjusted automatically, the fan runs at a faster speed and the windows are rapidly cleared of ice and moisture.

The air flow can be increased or decreased by turning the right switch.

To return to automatic mode: press button  or **AUTO**.

Heated rear window, see page 157.

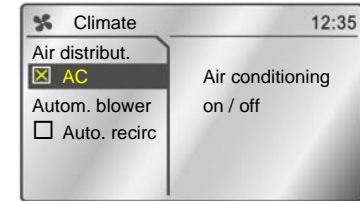

17164 T

Activating and deactivating air conditioning compressor

If no cooling or dehumidification is required, switch the air conditioning compressor off (maximum energy savings): Mark menu item **AC** from the manual settings menu and select by pressing. **Eco** appears on the display.

Inflowing air is neither cooled nor dehumidified. This restricts the level of comfort provided by the electronic climate control system. This may cause the windows to mist up, for example.

To activate cooling: Select menu item **AC** from the manual settings menu and press to activate cooling.

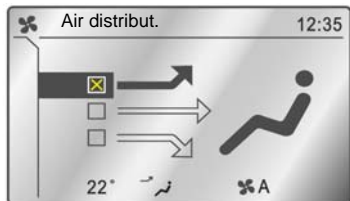

17165 T

Air distribution

Press the centre switch. The possible air distribution settings appear one after another in the display.

Air distribution can also be set in the **Air distribut.** menu:

- Up Air distribution to windscreen and front door windows.
- Centre Air distribution to vehicle occupants via front adjustable vents.
- Down Air distribution to footwell.

Return to automatic air distribution:

Deactivate corresponding setting or press button **AUTO**.



18497 T

Air flow

Turn right switch right or left. The selected fan speed is indicated with **✪** and the number in the display.

At speed **0** both the fan and cooling (air conditioning compressor) are switched off.

To return to automatic mode: Press **AUTO** button.

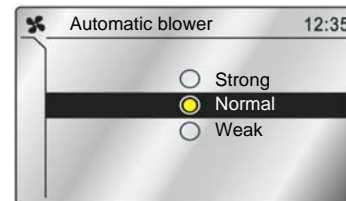

17167 T

Fan control in automatic mode*

Fan regulation in automatic mode can be modified.

Select menu item **Automatic blower** from the manual settings menu and select the desired fan control.

Depending on the setting, the maximum air flow, and thereby the noise level, will increase.

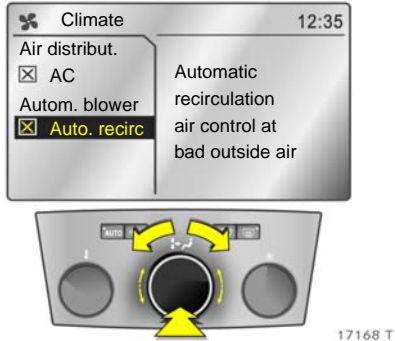

Switching automatic recirculation on or off

The automatic air recirculation system has an air quality sensor to detect harmful gases in the outside air, in which case it will switch automatically to recirculation.

Select menu item **Auto. recirc** from the manual settings menu and switch it on or off by pressing.

Switch to manual air recirculation as necessary.

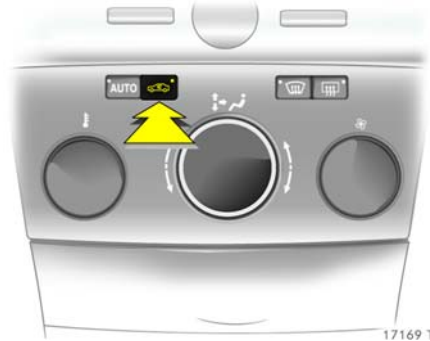

Manual air recirculation mode

The air recirculation system prevents the entry of outside air and the air in the passenger compartment is circulated.

Press button , the control indicator in the button will illuminate.

The exchange of fresh air is reduced in air recirculation mode. The quality of the passenger compartment air deteriorates which may cause the vehicle occupants to feel drowsy. In operation without cooling the air humidity increases, so the windows may mist up. Consequently, manual air recirculation should only be run for short periods of time.

To deactivate manual air recirculation: Press button  again. The control indicator in the button will go out.



Air conditioning with the engine not running

When the vehicle is stopped and the ignition off, the heat or cooling power still in the system can be used to condition the passenger compartment, for example when stopped at a level crossing.

Press button **AUTO** with the ignition off. **Residual air conditioning on** will appear briefly in the display.

The air conditioning will operate for a limited period of time.

To cancel air conditioning, press the **AUTO** button.

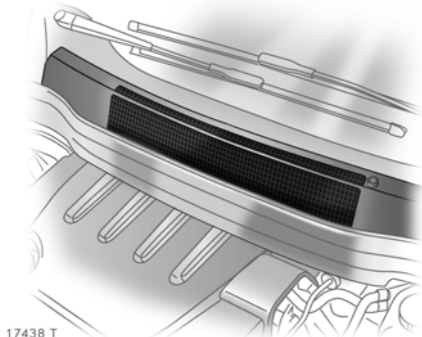

17438 T

Air intake

The air intakes in front of the windscreen in the engine compartment must be kept clear to allow air intake. Remove any leaves, dirt or snow.

Pollen filter

The pollen filter cleans dust, soot, pollen and spores from the air entering from outside. The active carbon layer ✱ eliminates most odours and harmful ambient gases from the air.

Have pollen filter replaced by a workshop in accordance with the intervals specified in the Service Booklet.

Note

If the windscreen mists up during damp weather, set the system as described under "Demisting and defrosting the windows" for a short time, see pages 160, 163, 171.

Cooling ✱ operates most effectively with the window and the sunroof ✱ closed. If the interior has become extremely hot after a long period of exposure to the sun, open window and sunroof ✱ for a short time so that the hot air can escape.

When cooling ✱ (air conditioning compressor) is switched on condensation forms, which is expelled from the underside of the vehicle.

At least one air vent must be open while cooling * (air conditioning compressor) is on in order to prevent the evaporator from icing up due to lack of air movement.

Cooling switches off automatically at low outside temperatures.

Do not cover the sensor on the instrument panel as this could cause the climate control * system to malfunction.

Maintenance

In order to ensure continuously efficient performance, the air conditioning compressor * must be operated for a few minutes once a month, irrespective of the weather and time of year. The climate control system, if present, handles this automatically while driving. Air conditioning compressor operation is not possible when outside temperatures are low.

In the event of a fault, contact a workshop for assistance.

Driving and operation

Easytronic *	176
Automatic transmission *	184
Automatic transmission with ActiveSelect *	190
Driving hints	198
Saving fuel, protecting the environment	200
Fuels, refuelling	202
Catalytic converter, exhaust gases	204
Drive Control Systems	209
Brake system	222
Anti-lock Brake System (ABS (ESP))	224
Wheels, tyres	225
Roof racks *	232
Towing equipment *	233
Caravan/trailer towing	237

Easytronic *

The semi-automatic Easytronic transmission permits manual (manual mode) or automatic gear shifting (automatic mode), both with automatic clutch control.

Warning

Disregard of these instructions may lead to injuries or endanger life.



Transmission display

Shows the mode and current gear.

The display flashes for a few seconds when **A**, **M** or **R** is selected with the engine running and the footbrake not activated.



18442 T

Starting the engine

Operate footbrake when starting the engine. The engine can only be started with the footbrake operated. "N" appears in the transmission display. If the footbrake is not operated the control indicator  illuminates in the instrument panel, and "N" flashes in the transmission display - the engine cannot be started.

Also the vehicle cannot be started if all brake lights have failed.

There is no need to select neutral before starting the engine. If a gear is engaged, the transmission automatically switches to neutral (N) before the engine starts when the footbrake is operated. This can lead to a slight delay in the starting process.

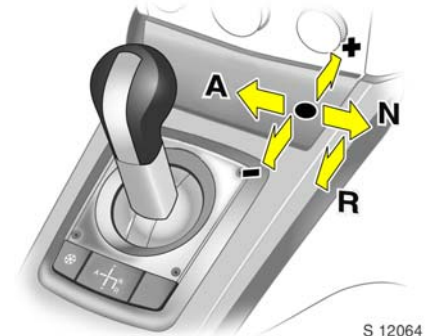

S 12064

Easytronic operation via the selector lever

Always move the selector lever in the appropriate direction as far as it will go. Upon release, it automatically returns to the centre position. Pay heed to the gear/mode indicator in the transmission display.

Move selector lever toward N
Neutral.



S 12096

Starting off

Depress the footbrake, release the handbrake and move the selector lever to **A**, **+** or **-**. Easytronic is in automatic mode and first gear is engaged (second gear if the Winter programme is active). "A1" appears in the transmission display ("A2" if the Winter programme is active). The vehicle begins to "creep" when the footbrake is released.

It is also possible to start off without depressing the footbrake if the accelerator pedal is operated directly after movement of the selector lever. If there is no immediate acceleration or the footbrake is not depressed, no gear is engaged and "A" flashes. After a few seconds, the display resumes showing "N". Start off by repeating the previously described procedure.

In Automatic mode, selection of other gears is automatic irrespective of driving conditions.

Move selector lever toward A

Switch between Automatic and Manual mode.

Manual gear shifting is possible in manual mode. "M" and the currently engaged gear appear in the transmission display.

If the engine speed is too low the Easytronic will automatically shift to a lower gear even in Manual mode. This prevents the engine from stalling.

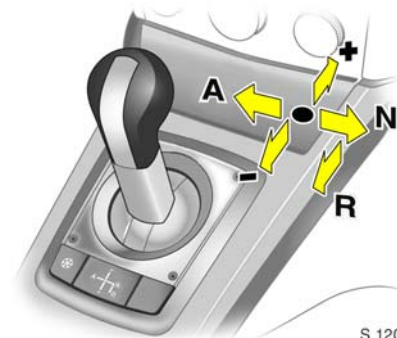

S 12064

Move selector lever toward + or -

- +** Shift to a higher gear
- Shift to a lower gear

If a higher gear is selected when the running speed is too low, or a lower gear when the speed is too high, no shift is effected. This prevents the engine from running at too low or too high revs.

Gears can be skipped by moving the selector lever repeatedly at short intervals.

If the vehicle is in automatic mode, on movement of the selector lever to + or - Easytronic shifts to manual mode and changes up or down. "M" and the currently engaged gear appear in the transmission display.

Move selector lever toward R

Reverse gear. Engage only when vehicle is stationary.

Depress the footbrake, release the handbrake and move the selector lever to R. Reverse gear is engaged. "R" appears in the transmission display.

The vehicle begins to "creep" when the footbrake is released.

It is also possible to start off in reverse without depressing the footbrake if the accelerator pedal is operated directly after movement of the selector lever. If there is no immediate acceleration or the footbrake is not depressed, no gear is engaged and "R" flashes. After a few seconds, the display resumes showing "N". Start off by repeating the previously described procedure.

Electronically controlled driving programmes

- By means of delayed gear changing (higher engine speeds) following a cold start, the operating temperature programme in automatic mode quickly and automatically brings the catalytic converter to the temperature required for optimum pollutant reduction.
- Adaptive programmes automatically adapt gear shifting in automatic mode to suit the driving conditions, such as if the vehicle is towing a caravan/trailer, has a high payload, or is being driven on inclines.

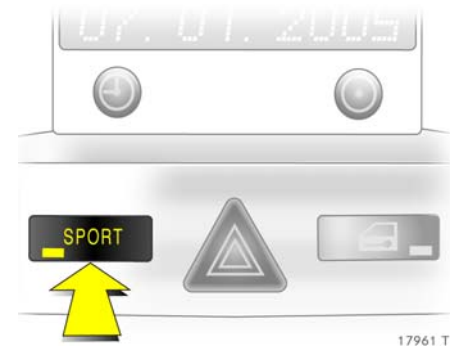

- When SPORT mode is engaged, shift times are reduced and the transmission shifts at higher engine speeds (unless cruise control is on). SPORT mode, see page 212.
- Winter programme: Press button ❄️, see next page.



S 12097

Winter programme ❄️

In the event of difficulties starting off on slippery roads, press button ❄️ ("A", currently engaged gear and ❄️ appear in the transmission display). Easytronic switches to automatic mode and the vehicle sets off in second gear.

The winter program is switched off by:

- pressing button ❄️ again,
- turning off the ignition.

In order to protect the Easytronic the winter programme automatically switches itself off at extremely high clutch temperatures.

If the Winter programme is activated, SPORT mode is deactivated.

If the vehicle is switched to manual mode while the winter programme is active, the winter programme is interrupted. The winter programme resumes upon return to automatic mode.

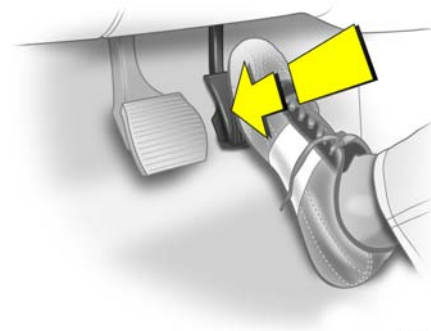

18451 S

Kickdown

Accelerator pedal pressed past the pressure point: below certain speeds, the transmission shifts down into a lower gear. Full engine power is available for acceleration.

During kickdown no manual gear shifting is possible.

When the engine speed approaches its upper limit, the transmission shifts to a higher gear during kickdown even in Manual mode.

Without kickdown this automatic shift is not effected in Manual mode.

If SPORT mode is engaged, the drive wheels may spin slightly when starting off with kickdown. This allows for maximum acceleration of the vehicle.

Engine braking

Automatic mode:

When driving downhill, Easytronic does not shift into higher gears until a fairly high engine speed has been reached. When braking, Easytronic shifts down in good time.

Manual mode:

To utilise the engine braking effect, select a lower gear in good time when driving downhill.

"Rocking the car"

If it becomes necessary to rock the vehicle to free it from sand, mud, snow or a hole, move the selector lever between **R** and **A** (or + or -) in a repeat pattern while applying light pressure to the accelerator pedal. Do not race the engine and avoid sudden acceleration.

This applies only to the exceptional circumstances mentioned above.

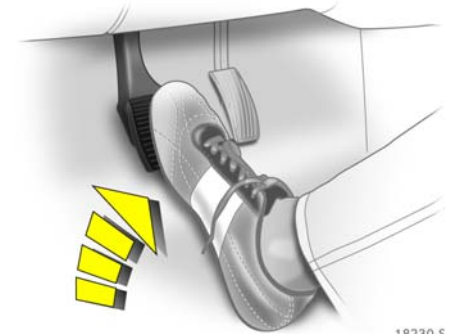

18230 5

Manoeuvring the vehicle

To manoeuvre the vehicle back and forth during attempts to park or in garage entrances the creeping movement can be utilised by releasing the footbrake.

Never actuate accelerator and brake pedals simultaneously.

To prevent damage, Easytronic disengages the "creep function" when the temperature of the automatic clutch is high.

Stopping the vehicle

In Automatic or Manual mode, when the vehicle has stopped first gear (with Winter mode engaged, second gear) is engaged automatically and the clutch released. In R reverse remains engaged.

A warning buzzer sounds when the driver's door is opened if the engine is running, a gear is engaged and the footbrake is not depressed. The vehicle creeps if the handbrake is not engaged. Move the selector lever to N and apply the handbrake.

When stopping on gradients, engage the handbrake or depress the brake pedal. To prevent overheating of the clutch, do not increase engine speed to ensure smooth idling when in gear.

To prevent damage to the Easytronic, the clutch is closed automatically at high clutch temperatures.

Switch off engine if stopping for a lengthy period, e.g. in traffic jams or at level crossings.

Vehicle storage

Before leaving the vehicle:

- Engage handbrake.
- Remove the ignition key or, with the Open&Start system , remove the electronic key from the vehicle.

The most recently engaged gear (indicator in transmission display) remains engaged. With N, no gear is engaged.

When the ignition is switched off the Easytronic no longer responds to movement of the selector lever.

Lock the vehicle. Otherwise the battery may become discharged if the vehicle is parked for long periods.

If the handbrake has not been applied, the control indicator  flashes for a few seconds after the ignition is switched off.

With the engine off and the handbrake not applied, when the driver's door is opened a warning buzzer sounds and the control indicator  flashes; switch on ignition, engage gear, switch off ignition and apply handbrake.



17028 T

Fault

Control indicator  illuminates in the event of a fault in the Easytronic system. In the event of serious faults, "F" also appears in the transmission display.

It is possible to continue driving if only control indicator  illuminates. Manual mode can then no longer be selected.

If "F" appears in the transmission display, continued driving is not possible.

Have the cause of the fault eliminated by a workshop. The self-diagnosis integrated into the system facilitates rapid fault identification.

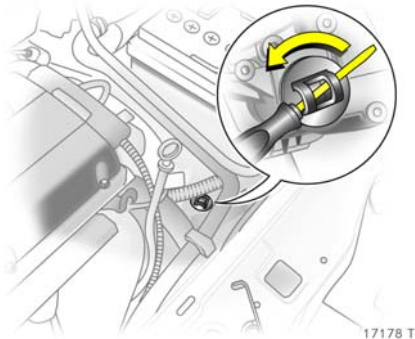

Interruption of power supply

The clutch is not disengaged if the vehicle battery is discharged and a gear has been selected. The vehicle cannot move.

If the battery is flat, start the vehicle using jump leads, see page 243.

If the cause of the power failure is not a discharged battery, contact a workshop. If the vehicle must be removed from flowing traffic, release the clutch on vehicles with 5-speed Easytronic. On vehicles with 6-speed Easytronic, the clutch cannot be released ✱; if the vehicle must be moved, raise vehicle at the front to tow.

To disengage the clutch (only on vehicles with 5-speed Easytronic)

1. Apply handbrake and switch off ignition.
2. Prop bonnet open, see page 241.

3. Clean Easytronic around the cap (see figure) so that no dirt can get into the opening when the cap is removed.
4. Rotate cap to slacken and remove by lifting upwards, see figure.
5. Turn the adjusting screw clockwise using a flat-head screwdriver (vehicle tools ✱, see page 251) until clear resistance can be felt. The clutch has now been disengaged.

Do not turn beyond the resistance, since this can damage the Easytronic.

6. Fit cleaned cap again. The cap must be in full contact with the housing.

Towing the vehicle and starting the engine is not permitted when the clutch has been released in this way, although the vehicle can be moved a short distance.

Contact a workshop immediately for assistance.

Automatic transmission *

The automatic transmission * allows automatic selection.

The engine can only be started when the gear selector is in position **P** or **N**. When starting in position **N**, depress the footbrake or apply the handbrake. After starting the engine, depress the brake before selecting a gear. Do not accelerate whilst selecting a gear. If a gear has been selected and the brake is released, the vehicle will "creep". Never operate the accelerator and the brake pedal simultaneously. The selected gear is displayed in the transmission display.

Warning

Disregard of these instructions may lead to injuries or endanger life.

Only select **3**, **2** or **1** to prevent automatic upshifting or as an aid in engine braking.



Transmission display

Display of mode or selected gear in left position of transmission display. The gear that has been selected by the transmission appears in the right position of the transmission display.

- P** Park position
- R** Reverse gear
- N** Neutral
- D** Drive position
- 3, 2, 1** Selected gear *



Selector lever positions **P**, **R**, **N** and **D**

- P** Park position. Front wheels locked. Only engage when the vehicle is stationary and the handbrake is applied. "P" appears on the transmission display.
- R** Reverse gear. Only engage when the vehicle is stationary. "R" appears on the transmission display.
- N** Neutral or idle. "N" appears on the transmission display.
- D** Drive position for normal driving in 1st gear to highest gear. "D" and the current gear appear in the transmission display.

The selector lever can only be moved from **P** when the ignition is switched on and the footbrake depressed (selector lever lock).

To engage **P** or **R**, push button on selector lever.

The engine can only be started with lever in position **P** or **N**. When position **N** is selected, press footbrake or engage handbrake before starting.

Do not accelerate during the selection procedure.

Gears 3, 2, 1



3, 2, 1 Transmission does not shift above the selected gear

Press button on selector lever to engage **3** or **1**.

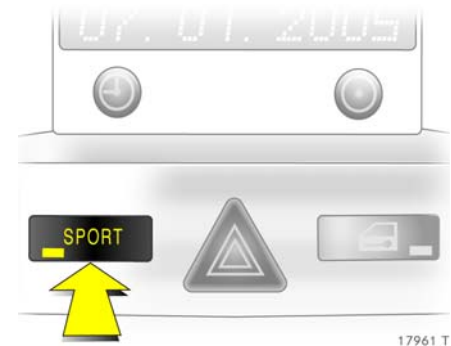
The current gear is displayed in the transmission display.



Electronically controlled driving programmes

- When **SPORT** mode is engaged, the transmission shifts at higher engine revs (unless cruise control is on). Control indicator  illuminates in the transmission display, see page 184. **SPORT** mode, see page 212.
- **Winter programme**: Press button , see next page.

- Automatic neutral shift function automatically sets the transmission to **N** to reduce fuel consumption, e.g. at traffic lights.

Automatic neutral is activated when the following occur simultaneously:

- The selector lever is in automatic mode ,
- The selector lever is in position **3**, **2** or **1**
- The footbrake is depressed
- The vehicle is stationary
- The accelerator pedal is not actuated
- The transmission fluid temperature is greater than 0 °C

As soon as the brake is released and the accelerator pedal is depressed, the vehicle starts off in the usual manner.

- The operating temperature programme automatically brings the catalytic converter to the temperature that is required for optimum emission reduction after a cold start by selecting an appropriate gear (increased engine revs).
- The adaptive programme automatically tailors gearshifting to the driving conditions, e.g. greater load or gradients.

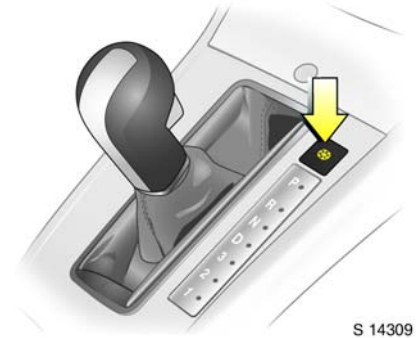

S 14309

Winter programme

Press button  if you are having problems starting off on a slippery road surface.

To activate

The winter programme can be activated in **P**, **R**, **N**, **D** and **3** ( illuminates in the transmission display). The vehicle starts off in 2nd gear.

To deactivate

The winter program is switched off by:

- pressing button  again,
- shifting to 2 or 1 manually,
- turning off the ignition.

In order to prevent damage, the winter program switches off automatically at high transmission oil temperatures.

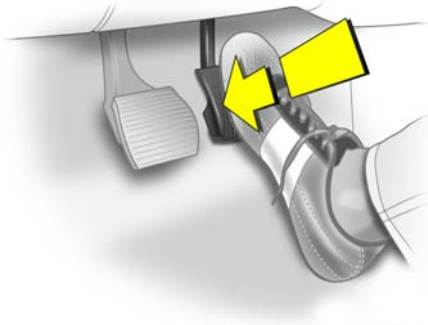

18451 S

Kickdown

Depressing the accelerator pedal past the pressure point: depending on the engine speed the transmission shifts to a lower gear. Full engine power is available for accelerating.

Engine braking

In order to utilise the engine braking effect when driving downhill, select drive range **3**, **2** or, if necessary, **1** in good time.

Gear **1** has the greatest braking effect. If gear **1** is selected at too high a speed, the transmission remains in second gear until the shift point for first gear is reached, e.g. as a result of deceleration.

"Rocking the car"

If it becomes necessary to rock the vehicle to free it from sand, mud, snow or a hole, move the selector lever from **D** to **R** in a repeat pattern while simultaneously applying light pressure to the accelerator pedal. Do not race the engine and avoid sudden acceleration.

This applies only to the exceptional circumstances mentioned above.

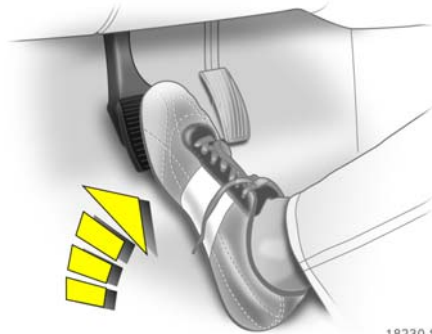

18230 S

Manoeuvring the vehicle

To manoeuvre the vehicle back and forth during attempts to park or in garage entrances, the vehicle's creeping movement can be utilised by releasing the brake pedal.

Never actuate accelerator and brake pedals simultaneously.

Stopping the vehicle

The selector lever can be left in the chosen gear with the engine running.

When stopping on gradients engage handbrake or depress brake pedal. To prevent overheating of the transmission, do not increase engine revolutions to ensure smooth idling while standing if a gear has been selected.

Switch off engine if stopping for a lengthy period, e.g. in traffic jams or at level crossings.

Before leaving the vehicle, first apply the handbrake. Then select **P**. Remove the ignition key or, with Open&Start system, remove the electronic key  from the vehicle. Lock the vehicle. Otherwise the battery may become discharged if the vehicle is parked up for long periods.

The ignition key can only be removed when the selector lever is in position **P**.

With the Open&Start system , "P" flashes in the transmission display for 10 seconds when the ignition is switched off if **P** has not been engaged or the handbrake has not been applied.



17028 T

Fault

If there is a problem with the automatic transmission, control indicator  illuminates. The transmission no longer shifts automatically. The vehicle can continue to be driven.

Illumination of control indicator  may also indicate a problem with the engine electronics, see page 206.

For diesel engines¹⁾ Z 19 DT and Z 19 DTH, illumination of control indicator  could also indicate that the diesel fuel filter must be drained of water - see page 300.

Have the cause of the fault eliminated by a workshop.

¹⁾ Sales designation, see page 310 and 311.

The transmission no longer shifts automatically. Vehicle can continue to be driven. Second gear is not available.

Forward gears 1, 3 and 4 must be shifted manually using selector lever:

- 1 = 1st gear
- 2 = 3rd gear
- 3, D = 4th gear

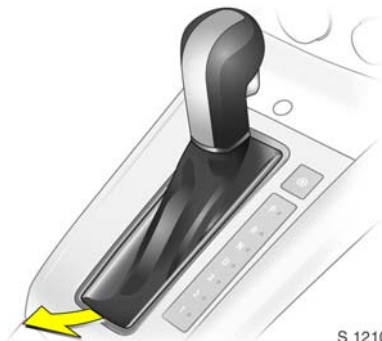

S 12100

Interruption of power supply

If the vehicle battery is flat, the selector lever cannot be moved out of position **P**.

If the battery is flat, start the vehicle using jump leads, see page 243.

If the battery is not the cause of the fault, release selector lever:

1. Apply handbrake.
2. Release selector lever trim from centre console at rear, fold upwards and rotate to the left.



S 12101

3. Push the yellow catch forward with a screwdriver and move the selector lever out of **P**.

4. Mount selector lever trim on centre console and refit.

Reselecting **P** causes locking again. Have a workshop eliminate the cause of the power loss.

Automatic transmission with ActiveSelect *

This automatic transmission * allows both automatic gearchanges (**automatic mode**) and manual gearchanges (**manual mode**) *.

The engine can only be started when the selector lever is in position **P** or **N**. When starting in position **N**, depress the footbrake or apply the handbrake. After the engine has started, depress the brake before selecting a gear. Do not accelerate whilst selecting a gear. If a gear has been selected and the brake is released, the vehicle will "creep". Never operate the accelerator and the brake pedal simultaneously. The selected gear is displayed in the transmission display, see page 184.

Warning

Disregard of these instructions may lead to injuries or endanger life.

Selecting **D** puts the transmission in automatic mode.

If the selector lever is moved to the left from the **D** position, manual mode is activated. Gearchanges can then be made manually by tipping the selector lever toward **+** or **-**.



Transmission display

Display of mode or selected gear in left position of transmission display. The gear that has been selected by the transmission appears in the right position of the transmission display.

- | | |
|----------|---|
| P | Park position |
| R | Reverse gear |
| N | Neutral |
| D | Automatic mode |
| M | Manual mode with display of selected gear |



S 12102

Selector lever settings P, R, N and D (automatic mode)

- P** Park position. Front wheels locked. Only engage when the vehicle is stationary and the handbrake is applied. "P" appears on the transmission display.
- R** Reverse gear. Only engage when the vehicle is stationary. "R" appears on the transmission display.
- N** Neutral or idle. "N" appears on the transmission display.
- D** Drive position for normal driving in 1st gear to highest gear. "D" and the current gear appear in the transmission display.

The selector lever can only be moved out of position **P** or **N** with the ignition switched on and the footbrake applied (selector lever lock). In selector lever position **N** the selector lever lock is activated after a delay and only if the vehicle is stationary.



S 12103

In position **P** or **N**, control indicator  illuminates red in the selector lever indicator strip if the selector lever is blocked.

To engage **P** or **R**, push button on selector lever.

The engine can only be started with lever in position **P** or **N**. When position **N** is selected, press footbrake or engage handbrake before starting.

Do not accelerate during the selection procedure.

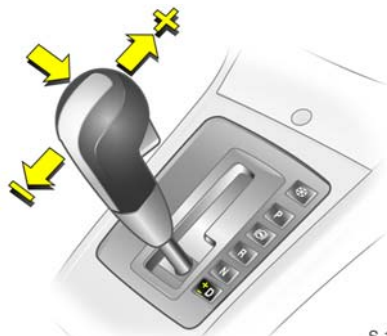

S 12104

ActiveSelect (manual mode)

Move selector lever out of position **D** and then forwards or backwards.

- + Shift to a higher gear
- Shift to a lower gear

If a higher gear is selected at a speed that is too slow or a lower gear is selected at a speed that is too high, the gear will not be changed. This prevents the revs from being too low or too high.

If the engine speed is too slow, the transmission automatically shifts down, but not if the gear was selected below a certain speed.

If a higher gear is selected below a certain speed, the transmission does not shift back.

No automatic shifting to a higher gear takes place at high engine revs.

For safety reasons, kickdown is also available in manual mode, see page 194.

The selected gear is displayed in the transmission display, see page 184.

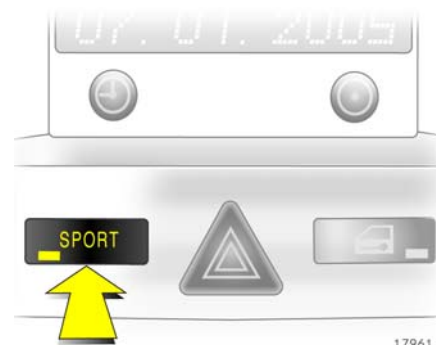

17961 T

Electronically controlled driving programmes

■ When SPORT mode is engaged, the transmission shifts at higher engine revs (unless cruise control is on). Control indicator  illuminates in the transmission display, see page 190.

SPORT mode, see page 212.

■ Winter programme: Press button , see next page.

- Automatic neutral shift function automatically sets the transmission to **N** to reduce fuel consumption, e.g. at traffic lights.

Automatic neutral is activated when the following occur simultaneously:

- The selector lever is in automatic or manual mode
- The footbrake is depressed
- The vehicle is stationary
- The accelerator pedal is not actuated
- The transmission fluid temperature is greater than 0 °C

As soon as the brake is released and the accelerator pedal is depressed, the vehicle starts off in the usual manner.

- The operating temperature programme automatically brings the catalytic converter to the temperature that is required for optimum emission reduction after a cold start by selecting an appropriate gear (increased engine revs).
- The adaptive programme automatically tailors gearshifting to the driving conditions, e.g. greater load or gradients.



S 12105

Winter programme ❄️

Press button ❄️ if you are having problems starting off on a slippery road surface.

To activate

The winter programme can be operated in automatic mode (❄️ illuminates in transmission display, see page 190). The vehicle starts off in 2nd or 3rd gear depending on the nature of the road surface.

To deactivate

The winter program is switched off by:

- pressing button  again,
- changing to manual mode,
- turning off the ignition.

In order to prevent damage, the winter program switches off automatically at high transmission oil temperatures.

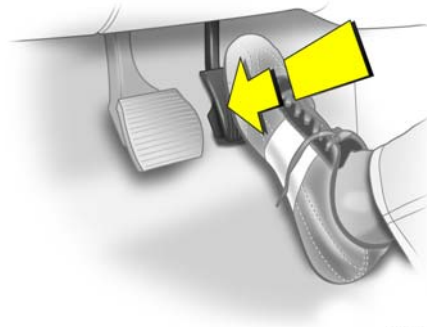

18451 S

Kickdown

Depressing the accelerator pedal past the pressure point: depending on the engine speed the transmission shifts to a lower gear. Full engine power is available for accelerating.

For safety reasons kickdown is available in both automatic and manual mode.

Engine braking

The automatic transmission automatically selects the driving programs with the best possible braking effect.

If necessary, lower gears can also be selected in manual mode to increase the braking effect. 1st gear has the greatest braking effect.

"Rocking the car"

If it becomes necessary to rock the vehicle to free it from sand, mud, snow or a hole, move the selector lever from **D** to **R** in a repeat pattern while simultaneously applying light pressure to the accelerator pedal. Do not race the engine and avoid sudden acceleration.

This applies only to the exceptional circumstances mentioned above.

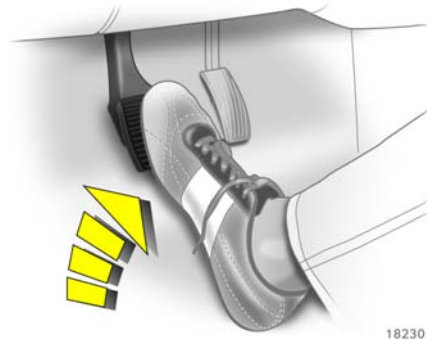

18230 5

Manoeuvring the vehicle

To manoeuvre the vehicle back and forth during attempts to park or in garage entrances, the vehicle's creeping movement can be utilised by releasing the brake pedal.

Never actuate accelerator and brake pedals simultaneously.

Stopping the vehicle

The selector lever can be left in the chosen gear with the engine running.

When stopping on gradients engage handbrake or depress brake pedal. To prevent overheating of the transmission, do not increase engine revolutions to ensure smooth idling while standing if a gear has been selected.

Switch off engine if stopping for a lengthy period, e.g. in traffic jams or at level crossings.

Before leaving the vehicle, first apply the handbrake. Then select **P**. Remove the ignition key or, with Open&Start system, remove the electronic key  from the vehicle. Lock the vehicle. Otherwise the battery may become discharged if the vehicle is parked up for long periods.

The ignition key can only be removed when the selector lever is in position **P**.

If the selector lever is not in position **P** when the ignition is switched off, control indicator  and **P** flash in the selector lever indicator strip, see Fig. S 12103 on page 191. Move the selector lever to position **P**.

With the Open&Start system , "P" flashes in the transmission display for 10 seconds when the ignition is switched off if **P** has not been engaged or the handbrake has not been applied.



17028 T

Fault

If there is a problem with the automatic transmission, control indicator  illuminates. The transmission no longer shifts automatically. The vehicle can continue to be driven.

Illumination of control indicator  may also indicate a problem with the engine electronics, see page 206.

For diesel engines¹⁾ Z 19 DT and Z 19 DTH, illumination of control indicator  could also indicate that the diesel fuel filter must be drained of water - see page 300.

Have the cause of the fault eliminated by a workshop.

2nd gear and the highest gear can be selected in manual mode. Depending on the nature of the problem, only the highest gear may be available.

Only the highest gear is available in **D** in automatic mode.

¹⁾ Sales designation, see page 310 and 311.

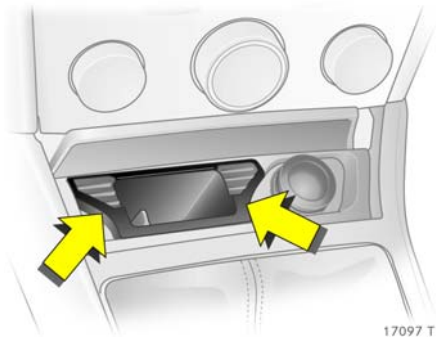

Interruption of power supply

If the vehicle battery is flat, the selector lever cannot be moved out of position **P** or **N**.

If the battery is flat, start the vehicle using jump leads, see page 243.

If the battery is not the cause of the fault, release selector lever:

1. Apply handbrake.
2. Remove the ashtray insert * or the rubber covering on the bottom of the stowage compartment * - see page 108.

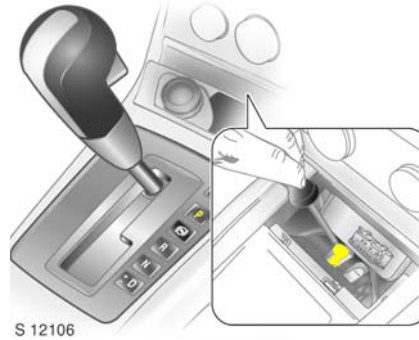

3. To open, push the yellow catch down with a screwdriver and move the selector lever out of **P** or **N**.
4. Refit the ashtray insert * or rubber covering on the bottom of the stowage compartment * - see page 108.

Reselecting **P** or **N** causes locking again. Have a workshop eliminate the cause of the power loss.

Driving hints

The first 600 miles (1000 km)

Drive your vehicle at various speeds. Do not use full throttle. Never allow the engine to labour at low revs.

Make good use of all gears. Depress the accelerator pedal a maximum of around three quarters of the available pedal travel in all gears.

Do not drive faster than three quarters of maximum speed.

Do not brake unnecessarily hard for the first 125 miles (200 km).

Never coast with engine not running

Many units will not function in this situation (e.g. brake servo unit, electro-hydraulic power steering). Driving in this manner is a danger to yourself and others.

Brake servo unit

When the engine is not running, the brake servo unit is no longer effective once the brake pedal has been depressed once or twice. Braking effect is not reduced, but significantly greater force is required for braking.

Electro-hydraulic power assisted steering

If the power-assisted steering fails when being towed with the engine switched off, the vehicle can still be steered, but considerably more force is required.

Driving in mountainous terrain or with a trailer/caravan

The cooling fan is electrically operated. Its cooling power is therefore independent of the engine speed.

Since a considerable amount of heat is generated at high engine speeds and less at slower speeds, do not shift down when climbing hills whilst the vehicle is still coping with the gradient in the higher gear.

Driving with a roof load

Do not exceed the permissible roof load - see pages 232, 325. For reasons of safety, distribute the load evenly and secure it properly with retaining straps. Adjust the tyre pressure to the load conditions. Do not drive faster than 75 mph (120 km/h). Check and retighten the straps frequently. Observe country-specific regulations. Roof loads are not permitted on the Astra TwinTop.

Switching off the engine

When you switch off, fans in the engine compartment may continue running for a time to cool the engine.

If the engine temperature is very high, e.g. after driving in mountainous terrain: allow the engine to idle for approximately two minutes in order to prevent heat accumulation.

Vehicles with turbocharged engine *

After running at high engine speeds or high engine loads, operate the engine briefly at a low load or run in neutral for approx. 30 seconds before switching off in order to protect the turbocharger.

Save energy – more miles

Please observe the running-in hints on this page and the tips for saving energy on the following pages.

Good, technically correct and economical driving ensures maximum durability and performance for your vehicle.

Overrun

The fuel supply is automatically shut off during overrun, e.g. when the vehicle is being driven down long gradients or when braking. To enable the overrun cut-off to take effect, do not accelerate during overrun and, if in manual transmission mode, do not de-clutch. To prevent damage to the catalytic converter, overrun cut-off is temporarily deactivated when the catalytic converter temperature is high.

Vehicles with turbocharged engine *

Flow-generated noises may be audible if the accelerator is released quickly on account of air flow in the turbocharger.

Engine speed

Drive in a low engine speed range for each gear as much as possible.

Warming up

After a cold start, the automatic transmission * or Easytronic * in automatic mode shifts into higher gears at higher rpm. This allows the catalytic converter to quickly reach the temperature required for optimum pollutant reduction.

Correct gear selection

Engine in neutral and without revving in the lower gears. Stop-and-go traffic and driving at a speed too high for the selected gear or transmission ratio increases wear and fuel consumption.

Change down

When decreasing speed, shift down into the next lowest gear. Do not slip the clutch with a high-revving engine. This is especially important when hill climbing.

Clutch operation

Always depress the clutch pedal hard to the floor to prevent shifting difficulties and transmission damage.

When driving do not use the pedal as a footrest; this will cause substantial clutch wear.

Cooling fan

The cooling fan is controlled via a thermostich and therefore only runs if necessary.

The cooling fan automatically switches on when the diesel particle filter is being cleaned * depending on the engine.

Pedals

Do not place any objects in the footwell which could slip under the pedals and inhibit the pedal travel.

To ensure the pedal travel is uninhibited, there must be no mats in the area of the pedals.

Battery care

When driving slowly or when the vehicle is stationary, e.g. in slow urban traffic, stop-and-go traffic or traffic jams, turn off all unnecessary electrical loads where possible (e.g. heated rear window, heated seats).

De-clutch when starting in order to relieve the strain on the starter and the battery.

Saving fuel, protecting the environment

Trend-setting technology

In the development and manufacture of your vehicle, environmentally-friendly and in the main recyclable materials were used. The production methods used to make your vehicle are likewise environmentally-friendly.

Recycling of production wastes keeps the circulation of material closed. Reduction of energy and water requirements also helps to conserve natural resources.

A highly advanced design means that your vehicle can be easily disassembled at the end of its working life, and the individual materials separated for subsequent re-use.

Materials such as asbestos and cadmium are not used. The refrigerant in the air conditioning system * is CFC-free.

New painting techniques employ water as a solvent.

End-of-life vehicle recovery

For detailed information on Vauxhall's ongoing commitment to achieving an environmentally sustainable future, including; design for recycling, take back of End-of-Life Vehicle (ELVs) and the recycling of ELVs, view www.Vauxhall.co.uk/recycling for details.

Energy and environment-conscious driving

- High noise levels and exhaust emissions are often a result of driving without due attention to saving energy and protecting the environment.

- You should therefore drive with energy in mind – "more miles with less fuel".

Reduce the noise level and exhaust emissions by adopting an environment-conscious driving style. This is extremely worthwhile and improves the quality of life.

Fuel consumption depends to a great extent on your own personal driving style. The following hints are intended to help you consume fuel at a rate that is as close as possible to the specified levels, see page 316.

Check your vehicle's fuel consumption every time you refuel. This facilitates early detection of any irregularities causing increased fuel consumption.

Warming up

- Full throttle and warming up at idle speed increase wear, fuel consumption, exhaust emission, the amount of pollutant in the exhaust and the amount of noise.
- Drive off as soon as possible after starting.

Uniform speed

- Hectic driving significantly increases fuel consumption, the exhaust emissions, the proportion of pollutant in the exhaust gas and the noise level.
- Do not accelerate and brake unnecessarily. Drive at uniform speed, watching the road.

Avoid frequent starting off and stopping e.g. at traffic lights, in short distance traffic and in queues of traffic by means of clever planning. Select roads with good traffic flow.

Idling

- The engine also consumes fuel when idling.
- If you have to wait for more than one minute, it is worthwhile switching off the engine. Five minutes of idling corresponds to approximately 0.6 miles (1 km) of driving.

Overrun

- The fuel supply is automatically shut off during overrun, e.g. when the vehicle is being driven down long gradients or when braking, see page 199.
- To enable the overrun cut-off to come into action and save fuel, do not accelerate or de-clutch during overrun.

Correct gear selection

- High revs increase engine wear and fuel consumption.
- Do not race your engine. Avoid driving at high engine speeds.

Making use of the tachometer helps to save fuel. Drive in a low engine speed range for each gear as much as possible with uniform engine speeds. Drive as often as possible in top gear, select the next higher gear as soon as possible, and only change down when the engine is no longer running perfectly smoothly.

High speed

- The higher the speed, the higher the consumption and the noise level. At top speed, you consume a great deal of fuel and produce excessive noise and exhaust emissions.

- Slightly releasing the accelerator pedal results in distinct fuel savings with no major loss of speed.

Drive at no more than around three quarters of maximum speed and you will use up to 50% less fuel, without losing a great deal of time.

Tyre pressure

- Inadequate tyre pressure, leading to higher road resistance, costs money in two ways: for more fuel and increased tyre wear.
- Regular checks (every 14 days) pay off.

Electrical loads

- The power consumption of electrical equipment increases fuel consumption.
- Switch off all auxiliary electrical loads (e.g. air conditioning ✱, heated rear window) when not needed.

Roof racks, ski-holders

- Due to air resistance, a roof load can increase fuel consumption by approx. 3.5 gal./1000 miles (1 l/100 km).
- Remove them if they are not being used.

Repair and maintenance

- Improper repairs or adjustment and maintenance work can increase fuel consumption. Do not carry out work on the engine yourself.

You may out of ignorance infringe environmental laws by not disposing of materials properly.

Appropriate parts might not be recycled.

Contact with some of the materials involved may pose a health hazard.

- We recommend that repair and maintenance be entrusted to your Vauxhall Authorised Repairer.

Extreme driving conditions

- Going up steep slopes, cornering, driving on poor roads and winter driving all increase fuel consumption.

Fuel consumption increases dramatically in urban traffic and at winter temperatures, especially on short trips when the engine operating temperature is not reached.

- Follow the hints given above to keep consumption to a minimum under such conditions.

Fuels, refuelling

Fuel consumption

Fuel consumption is determined under specific driving conditions, see page 316.

Special equipment increases the weight of the vehicle. As a result, they can increase fuel consumption and reduce the specified maximum speed.

For the first few thousand miles, friction between the engine and transmission components is higher. This increases fuel consumption.

Fuel for petrol engines

Normal commercial high-quality fuels with a maximum ethanol content of 5% in accordance with DIN EN 228 are suitable (for catalytic converter see page 204, for octane numbers see pages 310, 311). The quality thereof has considerable effect on the performance, running and service life of the engine. The additives mixed with the fuel are extremely important. For this reason you must only refuel with high-quality fuels containing additives.

Fuels with ethanol content greater than 5% do not comply with DIN EN 228 and must not be used unless the vehicle has been specifically developed and approved for these fuels.

Fuel with too low an octane number can cause pinking. No liability can be accepted for resulting damage.

Petrol with a higher octane number can always be used.

The ignition timing adjusts automatically to the grade of fuel used (octane number), see pages 310, 311.

Use of petrol with an octane rating of 95 will ensure economical driving.

For vehicles with Z20 LEH¹⁾ engine, use of 95 RON fuel reduces performance and torque.

Fuel for diesel engines

Diesel engines must be operated only on commercially available diesel fuel meeting the specifications of DIN EN 590.

Since January 2004, some oil companies have mixed their diesel fuel with upto 5% Bio fuel (FAME = Fatty Acid Methyl Esters) like RME (Rape-Oil Methyl Ester). This is in accordance with the current DIN EN 590 and does not harm the fuel/injection system. The characteristics of a diesel fuel mixed up with 5% Bio fuel (FAME) do not differ from conventional diesel fuel and do not influence the vehicle's driveability.

Important: Diesel fuel mixed with 5% FAME according to DIN EN 590 must not be confused with 100% Bio Diesel, which is not to be used in Vauxhall engines.

The flow and filterability of diesel fuel are temperature-dependent.

Diesel fuels with improved low temperature properties are therefore available on the market during the winter months. Make sure that you fill the tank with winter fuel before the start of the cold weather season.

Additives can be used with diesel fuels with winter properties that are guaranteed by the manufacturer and when using diesel fuel filters that are heated depending on the outside temperature.

Diesel fuels must not be diluted with fuels that are intended for petrol engines.

¹⁾ Sales designation, see pages 310 and 311.

Fuel filler cap

If replacing the fuel filler cap, be sure to use a genuine fuel filler cap for your model to ensure full functionality. Diesel-engined vehicles have special fuel filler caps.

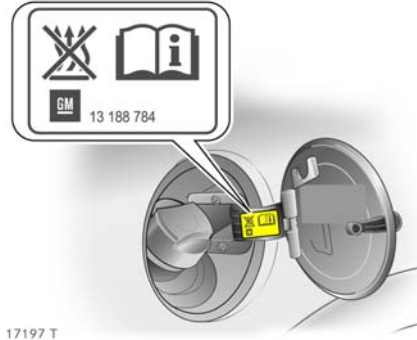

17197 T

Refuelling**⚠ Warning**

Care must be taken when handling fuel.

Before refuelling, switch off the engine and where applicable any auxiliary heating with combustion chambers (see sticker on fuel filler cap). Switch off mobile phones.

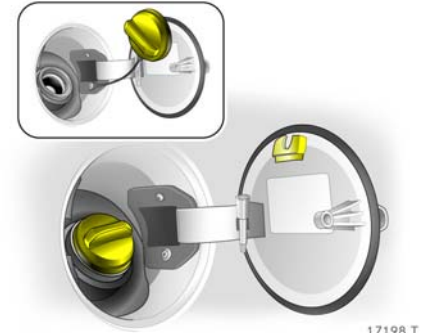

17198 T

Fuel filler neck at right rear side of vehicle.

The tank flap is locked together with the doors, see page 40.

Open the tank flap.

Unscrew the fuel filler cap, remove and suspend from the tank flap.

The fuel tank has a limiting system which prevents overfilling of the tank.

Correct filling depends to a large extent on proper operation of the fuel dispensing pump:

1. Fully insert the pump nozzle and switch it on.
2. After automatic switch off, the specified tank capacity is reached after continued, measured filling. Leave the filler nozzle in place until the stop.

To close, position the fuel filler cap and rotate past the resistance until the cap audibly clicks over the retainer.

Close fuel tank cover.

Wipe off any overflowing fuel immediately.

Warning

Fuel is flammable and explosive. When handling fuel or in the immediate vicinity, avoid naked flames or sparks. Do not smoke. This also applies where the presence of fuel is revealed by its characteristic smell. If fuel odours occur in the car, have a workshop eliminate the fault immediately.

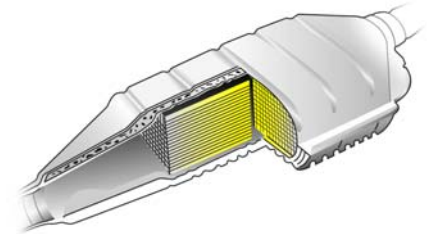

17199 T

Catalytic converter, exhaust gases

Catalytic converter for petrol engines

Leaded fuel will damage the catalytic converter and parts of the electronic system, rendering them inoperative.

High quality fuels other than those listed on pages 202, 310, 311 (e.g. LRP¹⁾) could damage the catalytic converter.

¹⁾ **LRP = Lead Replacement Petrol.**



Damage to the catalytic converter or the vehicle may result if the following points are not observed:

- On ignition faults, uneven running after cold start, a clear drop-off in engine power or other unusual operating symptoms which could indicate a fault in the ignition system, contact a workshop as soon as possible. Continue driving if necessary for a short time at low speed and low revs.

Irregular engine running and a loss of engine power when the Electronic Stability Program (ESP^{Plus} ) comes into action are the result of operating conditions and are therefore of no significance - see page 210.

- If unburned fuel enters the catalytic converter, this may result in overheating and irreparable damage to the catalytic converter.

You should therefore avoid unnecessarily long use of the starter when starting off, running the tank dry (an irregular fuel supply will lead to overheating) and starting the engine by pushing or towing.

- If the control indicator  flashes to indicate emissions, back off until the flashing stops and the control indicator illuminates. Contact a workshop immediately. Control indicator for emissions , see page 206.

Catalytic converter for diesel engines

Damage to the catalytic converter or the vehicle may result if the following points are not observed:

- On uneven running, a clear drop-off in engine power or other unusual operating symptoms, contact a workshop as soon as possible. Continue driving if necessary for a short time at low speed and low revs.

Irregular engine running and a loss of engine power when the Electronic Stability Program (ESP^{Plus} ) comes into action are the result of operating conditions and are therefore of no significance - see page 210.



17004 T

Controlling exhaust emission

Some of the damaging substances in the exhaust such as carbon monoxide (CO), hydrocarbons (HC) and nitrous oxides (NO_x) are reduced to a minimum by making structural changes – mainly in the injection system and the ignition system in conjunction with the catalytic converter.



17352 T

Control indicator for exhaust

Illuminates when the ignition is switched on and during the start attempt. Goes off shortly after the engine starts running.

Illuminated with the engine running indicates a fault in the exhaust gas cleaning system. The permitted emissions may be exceeded. Contact a workshop immediately.

Flashing with the engine running indicates a fault which could lead to catalytic converter damage. You may continue driving without damage if you back off until flashing stops and the control indicator comes on. Contact a workshop immediately.



17028 T



Control indicator for engine electronics

Illuminates for a few seconds after the ignition is switched on.

If it illuminates when the engine is running, there is a fault in engine or transmission electronics. The electronic system switches to an emergency running programme. Fuel consumption may be increased and the driveability of the vehicle may be impaired.

In some cases, faults can be eliminated by switching off the engine and restarting. If the control indicator comes on again when the engine is running, contact a workshop to eliminate the cause of the fault.

If it illuminates briefly, but does not recur, it is of no significance.

Illumination of  can indicate water in the diesel fuel filter , at the same time a message appears in the service display, see page 120. Have a workshop check the fuel filter for possible water residue.

If it flashes after the ignition is switched on, there is a fault in the immobiliser system. The engine cannot be started, see page 31.

Exhaust gases

Warning

Engine exhaust gases contain poisonous carbon monoxide, which is colourless and odourless and could be fatal if inhaled.

If exhaust gases penetrate the vehicle interior, open a window and contact a workshop.

Avoid driving with an open luggage compartment. Otherwise, exhaust gases could penetrate the interior.

During the first drive smoke may develop because of wax and oil evaporating on the exhaust system. Park the vehicle in the open for a while after the first drive and avoid inhaling the fumes.

Diesel particle filter

The diesel particle filter system removes polluting soot particles out of the engine exhaust gases. The system includes a self-cleaning function that operates automatically while driving. The filter is cleaned by burning the trapped soot particles at a high temperature. There may be an increase in fuel consumption, exhaust smell, and engine cooling fan operation  during the self-cleaning operation.



The self-cleaning function can not operate automatically during certain driving situations where the engine does not reach its normal operating temperature. An example of this would be driving only short distances in cold weather. If the filter needs cleaning and recent driving situations did not allow the function to automatically operate, then the control indicator  will flash. If this occurs, then you may continue to drive the vehicle normally. The vehicle will not be damaged and does not require service.

The self-cleaning function will automatically operate while driving after the engine has reached its normal operating temperature. The control indicator  will continue to flash until the self-cleaning operation is complete. This may take up to 20 minutes of driving. The time will be shorter at higher vehicle speeds. If the vehicle is not moving for more than a few minutes, then the self-cleaning function will not operate. Operation will continue when driving resumes.

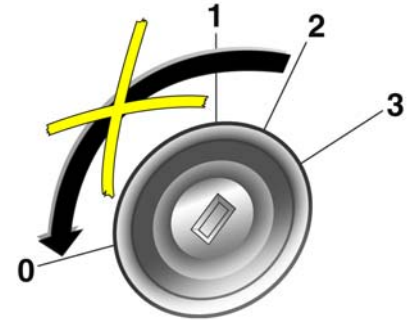

We recommend that you do not turn the ignition off until the self-cleaning operation is complete. If you must turn the ignition off before the operation is complete, then the operation will automatically resume when driving the next time and after the engine has reached its normal operating temperature.



18538 T

The control indicator  goes off as soon as the self-cleaning operation is complete.

Maintenance

Have all maintenance work carried out at the intervals specified. We recommend that you entrust this work to your Vauxhall Authorised Repairer, who has proper equipment and trained personnel available. Electronic testing systems permit rapid diagnosis and remedy of faults. This way you can be certain that all components of the vehicle's electrical, injection and ignition systems operate correctly, that your vehicle has a low level of pollutant emission and that the catalytic converter system will have a long service life.

You are thereby making an important contribution towards keeping the air clean and compliance with emissions legislation.

Checking and adjustment of the fuel-injection and ignition systems is part of the scope of inspection. For this reason you should have all maintenance work carried out at the intervals specified in your Service Booklet.

Drive Control Systems

Interactive Driving System (= IDS+) *

IDS+ unites the sensors and control units of the Electronic Stability Program (ESP^{plus}), Anti-lock Brake System (ABS) and Continuous Damping Control (CDC). This provides both excellent driving dynamics and greater safety.

Electronic Stability Programme (ESP®Plus) *

ESP®Plus improves driving stability as necessary in any driving situation regardless of the type of road surface or tyre grip. It also prevents the drive wheels from spinning irrespective of road surface and tyre grip.

The system monitors vehicle movements. As soon as the vehicle starts to swerve (understeers/oversteers) engine output is reduced (the sound of the engine changes) and individual wheels are specifically braked. This considerably improves the driving stability of the vehicle on snow and ice and on wet or slippery road surfaces.

ESP®Plus is ready for operation as soon as the ignition is switched on and control indicator  goes out.

When ESP®Plus comes into action,  flashes.

The vehicle is now in a critical situation; ESP®Plus allows you to keep control of the vehicle and reminds you to match your speed to the road conditions.

Warning

Do not let this special safety feature tempt you into taking risks when driving.

Traffic safety can only be achieved by adopting a responsible driving style.



17200 T

Control indicator

Illuminates for a few seconds when the ignition is switched on. The system is now ready for operation.

Flashing during driving:

This shows the system has come into action. The engine output may be reduced (the sound of the engine changes) and the vehicle may be braked automatically to a small degree.

Illuminates while driving:

The system is switched off or a fault is present. Continued driving is possible. The driving stability can however deteriorate depending on road surface conditions.

Re-engage ESP®^{Plus} or have the cause of the fault eliminated by a workshop. The self-diagnosis integrated into the system facilitates rapid fault identification.

Switching off *

With SPORT mode * engaged (LED in **SPORT** button illuminated), the ESP®^{Plus} can be disengaged for sports performance.

Hold the **SPORT** button depressed for around 4 seconds. Control indicator ⚠ will illuminate. **ESPoff** will also appear in the service display, see page 120.

Warning

ESP®^{Plus} should not be deactivated if one of the run-flat tyres * has no pressure.

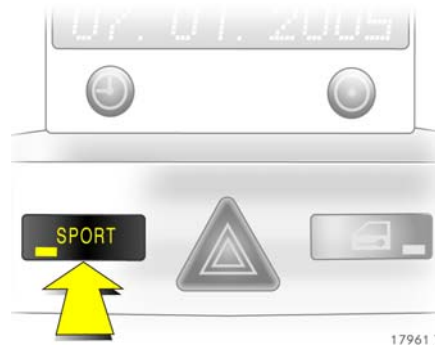

ESP®^{Plus} is reactivated by pressing the **SPORT** button again or switching on the ignition.

SPORT mode, see page 212.

Continuous Damping Control * (CDC)

CDC adapts vehicle damping to the current driving situation and road conditions.

The system continually monitors wheel and vehicle movements and immediately modifies the damping of each shock absorber. Chassis calibration is optimally adapted to the driving situation and road conditions.

When SPORT mode is enabled the damping control is adapted for a sportier driving style. This adaptation leads to "harder" chassis calibration.

SPORT mode - see right column.



17201 T

Control indicator IDS+ for Continuous Damping Control

Illuminates for around 10 seconds after opening the driver's door. Illumination during driving indicates a fault in the system. The system is not functioning. For safety reasons, switches to the harder chassis setting. Have the cause of the fault eliminated by a workshop. The self-diagnosis integrated into the system facilitates rapid fault identification.

SPORT mode *

SPORT mode is used to change damping *, steering *, throttle application * and the shift point for automatic transmission * and Easytronic * while driving.

Damping and steering become more direct and provide better contact with the road surface. The engine reacts more quickly to accelerator movements.

For automatic transmission * and Easytronic *, the shift times are reduced and gear changes occur at higher engine speeds (not when cruise control is on).

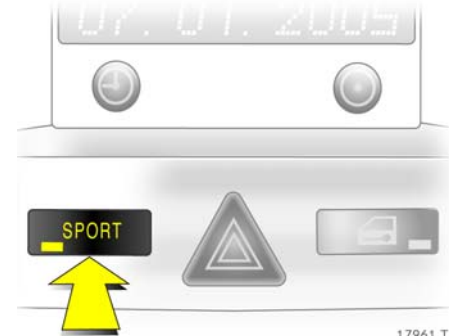

17961 T

To activate

Press the **SPORT** button. The LED in the button illuminates.

In vehicles with automatic transmission * or Easytronic * the control indicator  illuminates in the transmission display.

SPORT mode cannot be activated if the Winter programme * is running (vehicles with automatic transmission * or Easytronic *). Winter programme - see pages 180, 186, 193.

To deactivate

Briefly press the **SPORT** button again or switch off the ignition. The LED in the button goes out.

Holding it pressed switches off ESP®^{Plus}, see page 211. SPORT mode remains engaged.

Switching the winter programme on * (vehicles with automatic transmission * or Easytronic *) switches SPORT mode off.

For winter programme, see pages 180, 186, 193.



17201 T



Control indicator IDS+ for SPORT mode

Illuminates for around 10 seconds after opening the driver's door. Illumination during driving indicates a fault in the system. The system is not functioning. Have the cause of the fault eliminated by a workshop. The self-diagnosis integrated into the system facilitates rapid fault identification.

Cruise control *

Cruise control can store and maintain speeds between 20 mph (30 km/h) and 125 mph (200 km/h). Deviation from the stored speed may occur when driving up or downhill.

For safety reasons the cruise control cannot be activated until the footbrake has been operated once.

Cruise control is operated with buttons , , and  on the turn signal stalk.

Do not use the cruise control if it is not advisable to maintain a constant speed (e.g. in situations presenting a danger to yourself and other road users, in heavy traffic or on winding, slippery or greasy roads).

214 Driving and operation

With automatic transmission ✱, only use cruise control in **D** or in automatic mode with Easytronic ✱.

When the cruise control is active, reaction times may be increased due to the different position of the feet.

Warning

The driver is always responsible for ensuring that vehicle speed is appropriate for the speed limit and driving conditions - even if cruise control is engaged. Failure to follow the instructions could lead to injuries or endanger life.



17202 T

Control indicator

When driving, control indicator  will illuminate as soon as the system is switched on.

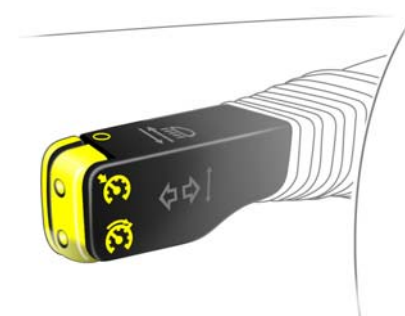

16990 T

To activate

Briefly press button : the current speed is stored and maintained. The accelerator pedal can be released.

Vehicle speed can be increased by depressing the accelerator pedal. When the accelerator pedal is released, the previously stored speed is resumed.

Increase

With cruise control active, hold down button  or briefly press it repeatedly: speed is increased continuously or in steps of 1.2 mph (2 km/h) without using the accelerator pedal.



When button  is released the current speed is stored and maintained.

Decelerate

With cruise control active, hold down button  or briefly press it repeatedly: speed is reduced continuously or in steps of 1.2 mph (2 km/h).



When button  is released the current speed is stored and maintained.

To deactivate

Briefly press button : Cruise control is switched off, control indicator  goes out and the vehicle slowly decelerates. To continue driving, depress the accelerator pedal in the usual manner.

For reasons of safety, cruise control deactivates under certain driving conditions.

For example:

- the vehicle's speed drops below approx. 20 mph (30 km/h) or
- the brake pedal is depressed or
- the clutch pedal is depressed or
- selector lever of automatic transmission  or Easytronic  in N.

Resuming the stored speed

Briefly press button  at a speed above 20 mph (30 km/h): the speed selected before the cruise control was switched off is resumed.

The value of the stored speed is deleted when the ignition is turned off.

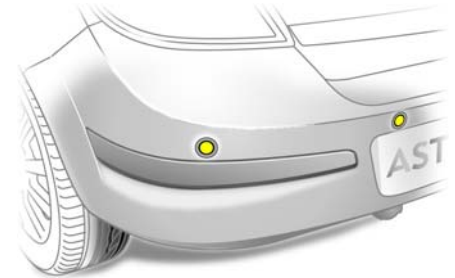

17203 T

Parking distance sensor 

The parking distance sensor makes reverse parking easier by measuring the distance between the vehicle and an obstacle at the rear, and giving an acoustic signal in the passenger compartment.

The system records the distance using four sensors in the rear bumper.

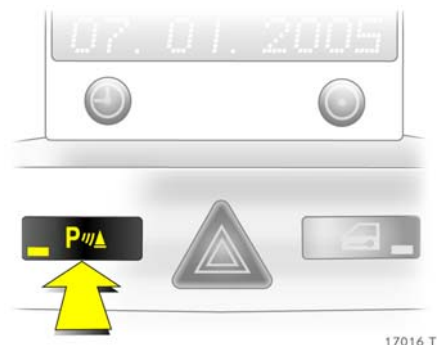

17016 T

To activate

The parking distance sensor system activates automatically when the ignition is switched on and reverse gear is engaged.

Its operational readiness is indicated by illumination of the LED in button **P**▲.

If the vehicle approaches an obstacle when reversing, a series of signals can be heard in the vehicle interior. The interval between the signals becomes shorter as the distance is reduced. If the distance is less than 30 cm, the signal will be continuous.

▲Warning

Under certain circumstances, various reflective surfaces on objects or clothing as well as external noise sources may cause the system to fail to detect obstacles. For this reason, care must be taken when reversing even if the parking distance sensor is operational. This is of particular importance when in the vicinity of pedestrians.

To deactivate

The system deactivates automatically when reverse gear is disengaged.

To deactivate the system when reverse gear is engaged, press button **P**▲. The LED in the button goes out.

To reactivate, press button **P**▲ again.



17204 T

Control indicator **P**▲

Illuminates:

Fault in system. The system is not functioning. Have the cause of the fault eliminated by a workshop. The self-diagnosis integrated into the system facilitates rapid fault identification.

Flashing:

The fault is due to sensors obstructed with snow or ice. The sensors must be undamaged and free of dirt, snow and ice.

Interference due to external sources of ultra sound (e.g. pneumatic drills, rotary machines). Once the source of interference is removed, the system will operate normally.

Caravan/trailer towing equipment ❄, caravan/trailer towing

The system automatically detects if a towbar is properly fitted to the vehicle.

When towing, plugging the trailer cable into the socket automatically switches the parking distance sensor off

Fitting rear load racks ❄

Rear load racks, e.g. bicycle racks, fitted near the sensors could disrupt the system.

Observe the note on the Astra TwinTop on page 58.



17205 T

Automatic level control ❄

Automatic level control makes it possible to keep the height of the vehicle constant when subjected to different loads in the rear (e.g. when towing a caravan or trailer). This significantly improves driving conditions.

The vehicle is automatically raised at the rear, increasing the spring travel and ground clearance.

The automatic level control system is activated after approx. 1.9 miles (3 km), depending on the vehicle loading and the nature of the road surface.

Headlight range adjustment, see page 146.

On function faults, do not utilise full load capacity. Have the cause of the fault eliminated immediately by a workshop.



17018 T



Deflation detection system (DDS = Deflation Detection System) *

The deflation detection system continuously monitors the speed of all wheels while driving. If a tyre loses pressure, it grows smaller and rotates more quickly than the other wheels. If the system detects a difference in speed, control indicator (⚠) illuminates red.

Stop immediately and check tyre pressure. Mount the spare wheel if necessary, see pages 249, 252.

The system is operational when the ignition is switched on and can detect pressure loss from a speed of 20 mph (30 km/h).

Control indicator 

If control indicator  illuminates red while driving, there is a loss of pressure. Stop immediately and check tyre pressures. A maximum speed of 50 mph (80 km/h) is permitted for run-flat tyres . Observe the information on page 230.

If the control indicator  illuminates yellow, there is a fault in the system. Have the cause of the fault eliminated by a workshop. The self-diagnosis integrated into the system facilitates rapid fault identification.

The control indicator flashes three times when the system is initialising.

 **Warning**

The deflation detection system does not replace manual checks with a suitable gauge.

Check tyre pressures at least every 14 days and prior to any long journey; the tyres should be checked when cold. Don't forget to check the spare .

Tyre pressure, see pages 227, 337.

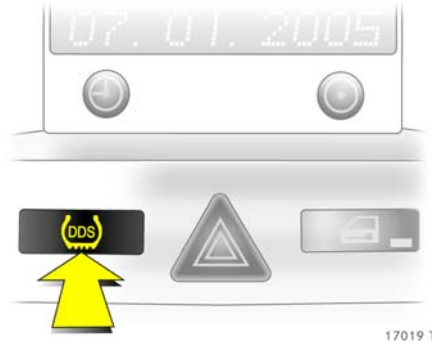
System initialisation

After correcting tyre pressure or changing a tyre/wheel, the system must be initialised: With the ignition switched on, press the **DDS** button for approx. 4 seconds. Control indicator  flashes 3 times. The system is operational after driving a certain distance.

Only initialise the system if all tyres have the prescribed pressure.

Tyre pressure monitoring system 

The tyre pressure monitoring system continually checks the pressure and speed of all four wheels while driving.

A pressure sensor is integrated in each wheel. Once a minute, the pressure of each tyre is sent to a control unit, where it is compared. If the system detects one or more pressure differences, a message appears on the information display.

The current tyre pressures are displayed in the Info display.

For the system to be operational, all wheels must be equipped with pressure sensors and all tyres must be filled to the prescribed pressure. The tyre pressure monitoring system automatically detects if the vehicle is being driven with a load of up to 3 persons or a full load.

Once the ignition is switched on, the system is operational and will continuously monitor the tyre pressures at speeds of approx. 20 mph (30 km/h) and above.

Warning

The tyre pressure monitoring system does not replace manual checks with a suitable gauge.

Check tyre pressures at least every 14 days and prior to any long journey; the tyres should be checked when cold. Don't forget to check the spare ❄.

Tyre pressure, see pages 227, 337.

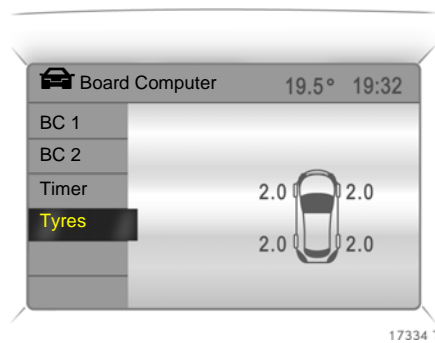

Display of current tyre pressure

Select menu item **Tyres** from the **Board Computer** menu.

The current pressure of each tyre is displayed.

Warning messages

A message is given on the information display to warn of inconsistent tyre pressures. In some versions, the message is displayed in abbreviated form.

For example, the following messages can be displayed:



A graphic indicating the left rear tyre is shown together with the current tyre pressure: Slight pressure deviation, reduce speed. Check pressure at next opportunity with appropriate gauge and correct if necessary.

On the colour information display this report will appear in yellow.



17354 T

A graphic indicating the front left tyre is shown together with the current tyre pressure: Significant pressure deviation or direct pressure loss! Steer out of flow of traffic as quickly as possible without endangering other drivers. Stop and check the tyres.

Mount the spare wheel * if necessary - see pages 249, 252. A maximum speed of 50 mph (80 km/h) is permitted for run-flat tyres *. Observe the information on page 230.

On the colour information display this report will appear in red.

Acknowledgement of warnings, see page 130.



17018 T

Control indicator (⚠)

If control indicator (⚠) illuminates up yellow while driving, there is a fault in the tyre pressure monitoring system. Fitting a wheel without pressure sensor (e.g. spare wheel 3) will also generate a fault in the system. Have the cause of the fault remedied by a workshop. The integral self-diagnostic feature of the system allows faults to be quickly remedied.

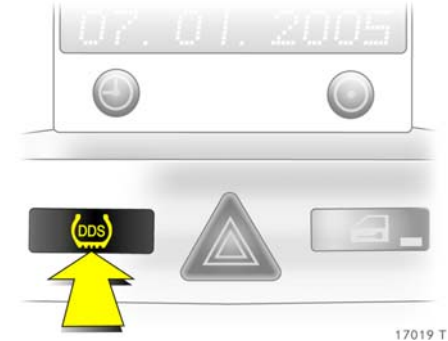

17019 T

System initialisation

The system must be initialised after a wheel/tyre change: With the ignition switched on, press button **DDS** approx. 4 seconds. Control indicator (⚠) flashes 3 times. The system is operational after driving a certain distance.

Only initialise the system if all tyres have the prescribed pressure (check when tyres are cold).

General information

The tyre pressure monitoring system does not function when the emergency or a spare wheel not fitted with a pressure sensor is used, and the control indicator (⚠) illuminates yellow. The tyre pressure display shows –.–. The tyre pressure is then monitored by the deflation detection system, see page 218.

If a complete set of wheels without tyre pressure control system sensors is mounted (e.g. four winter tyres), no error message will be displayed. The tyre pressure monitoring system is not operational. The tyre pressure of a set of wheels without sensors is monitored by the deflation detection system, see page 218.

Sensors for the tyre pressure monitoring system can be fitted on request by a workshop.

When manually checking tyre pressure with a pressure gauge, screw the adapter onto the valve. Tyre pressure, see page 337.

On each tyre change, the valve inserts and sealing rings for the tyre pressure monitoring system must be replaced by a workshop.

The use of commercially available liquid filled run-flat systems or repair kits can impair the function of the system. Vauxhall-approved systems can be used.

Radio transmitters (e.g. radio headphones, walkie-talkies) operated in the area could cause interference in the tyre pressure monitoring system.

Brake system

The brakes are an important factor for traffic safety.

To improve effectiveness, do not brake unnecessarily hard for the first 125 miles (200 km) after new brake pads have been fitted.

Brake pad wear must not exceed a specified limit. Regular maintenance as detailed in the Service Booklet is therefore of the utmost importance for traffic safety.

Have worn brake pads replaced by a workshop.

Tested and approved pads give optimum braking performance.

Brake pads worn to the minimum level cause grinding noises. You may continue to drive but have the pads replaced as soon as possible. To change the pads, contact a workshop.

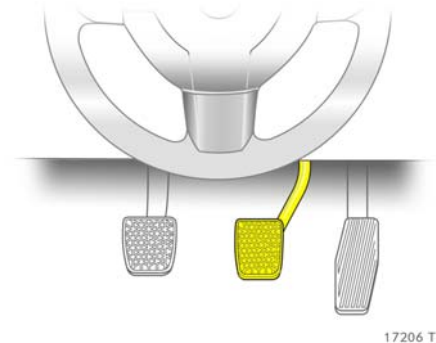

Brake assist

If the brake pedal is operated with a rapid, powerful push, the vehicle is automatically braked at full braking power in order to achieve the shortest possible braking distance when full-on braking occurs (brake assist).

Maintain steady pressure on the brake pedal for as long as full-on braking is to continue. When the brake pedal is released, the maximum brake force amplification is taken away.

Footbrake

The footbrake comprises two independent brake circuits.

If one brake circuit fails, the vehicle can still be braked with the other brake circuit. However the braking effect will occur at a lower pedal position and considerably more force is required. The braking distance is longer. Contact a workshop before continuing to drive.

To ensure the full pedal travel can be utilized, especially in case of a fault in one of the brake circuits, there must be no mats in the vicinity of the pedals, see page 199.

When the engine is not running, the support of the brake servo unit disappears once the brake pedal has been depressed once or twice. Braking effect is not reduced, but braking requires significantly greater force. This is especially important to bear in mind when towing.

Check the brake lights before starting out on a journey. On vehicles with check control ✱ the brake lights are checked automatically, see page 138.

Shortly after starting each journey the effectiveness of the brake system should be tested at low speed and without inconveniencing other traffic, especially if the brakes are wet, e.g. after the vehicle has been washed.

The brake fluid level should be checked regularly. If the brake fluid level is too low and the handbrake is not applied, control indicator (D) in the instrument panel illuminates, see page 114.

Hill Start Assist ✱ (HSA)

The system helps pull away on inclines. After releasing the footbrake, if the handbrake is not applied the brakes are only released after 2 seconds. As soon as the acceleration is sufficient to prevent rolling back, the brake is released.

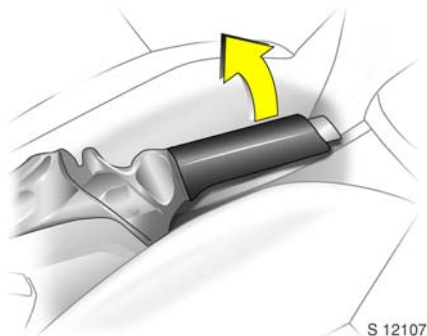

S 12107

Handbrake

Always apply handbrake firmly without operating the release button, and apply as firmly as possible on a downhill or uphill slope.

The mechanical handbrake acts on the brakes on the rear wheels. It engages automatically when applied.

To release the handbrake pull the lever up slightly, press the ratchet knob, and fully lower the lever.

To reduce the operating forces of the handbrake, depress the footbrake at the same time.



17208 T

Brake system control indicator (P)

The control indicator illuminates when the ignition is switched on if the handbrake is applied or if the brake or clutch fluid level is too low. Brake fluid - see page 302.

For vehicles with Easytronic*, the control indicator flashes for a few seconds when the ignition is turned off if the handbrake is not applied.

Warning

If the control indicator comes on when the handbrake is released, stop driving immediately. Contact a workshop for assistance.

Anti-lock Brake System (ABS (ABS))

ABS continually monitors the brake system and prevents the wheels from locking regardless of the type of road surface or tyre grip.

It starts to regulate the braking pressure as soon as a wheel shows a tendency to lock. The vehicle remains steerable, even in the event of very heavy braking, for instance on bends or when swerving to avoid an obstacle. Even in the case of full-on braking, the ABS makes it possible to drive round an obstacle without releasing the brakes.

ABS control is made apparent though a pulse in the brake pedal and the noise of the regulation process.

Warning

For optimum braking, keep the brake pedal fully depressed throughout the braking process, despite the fact that the pedal is pulsating. Do not reduce the pressure on the pedal.

Do not let this special safety feature tempt you into taking risks when driving.

Traffic safety can only be achieved by adopting a responsible driving style.



17209 T

Control indicator for ABS

It comes on for a few seconds after the ignition is turned on. The system is ready for operation when the control indicator goes out.

If the control indicator does not go out after a few seconds, or if it illuminates while driving, there is a fault in the ABS. The brake system remains operational without ABS regulation.

Self-check

Each time the ignition is turned on and the engine started, after moving away from a speed of around 1.9 mph (3 km/h) the system performs a self-check which may be audible.

Fault

Warning

If there is a fault in ABS, the wheels may be subject to locking due to braking that is heavier than normal. The advantages of ABS are no longer operational. The vehicle can no longer be steered and may swerve.

You can continue driving, provided you drive with care and anticipation.

Have the cause of the fault eliminated by a workshop. The self-diagnosis integrated into the system facilitates rapid fault identification.

Wheels, tyres

See page 337 for suitable tyres and restrictions.

Tyres fitted in the factory are adapted to the chassis and provide optimum driving comfort and safety.

Changing tyre/wheel type

Before conversion to other tyres or wheels, note the changes required.

If tyres of a different size than those fitted at the factory are used, the electronic speedometer may require reprogramming to ensure that the correct speed is displayed.

Warning

Use of unsuitable tyres or wheels may lead to accidents and render the vehicle unroadworthy.

Vehicles with tyre pressure monitoring system *

With winter tyres or after conversion to different wheel sizes, sensors for the tyre pressure monitoring system can be fitted by a workshop on request. Otherwise the system would not show the tyre pressure deviations.

Deflation detection system *, see page 218,
tyre pressure monitoring system *, see page 219.

Vehicles with run-flat tyres *

When switching wheels, e.g. when switching to winter tyres, use run-flat tyres as there is no spare wheel or tyre repair kit in the vehicle.

Run-flat tyres - see page 230.

Fitting new tyres

Fit tyres in pairs or in sets, which is even better. Ensure that tyres on one axle are

- the same size
- the same design
- the same make
- and have the same tread pattern.

Fit directional tyres such that they roll in the direction of travel. The rolling direction is indicated by a symbol (e.g. an arrow) on the sidewall.

Tyres fitted opposing the rolling direction (e.g. when a tyre is changed) should be refitted as soon as possible. This is the only way to obtain full benefit from the design properties of the tyre.

Run-flat tyres * must not be combined with conventional tyres.

When disposing of tyres, follow the legal requirements.

Some brands of tyres have a beaded edge for alloy wheels to protect against damage. If wheel trim is used on steel wheels with beaded-edge tyres, the following specification must be followed:

- Use of wheel trims and tyres that approved by Vauxhall for the vehicle in question and thereby fulfil all requirements for the wheel and tyre combination.
- If the wheel trims and tyres used are not Vauxhall-approved, the tyres must not have a beaded edge.

Warning

Use of unsuitable tyres or wheel trims could lead to sudden loss of air and thereby accidents.

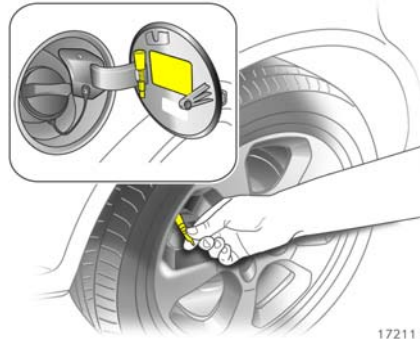

17211 T

Tyre pressure

Check tyre pressure, including the spare wheel, at least every 14 days and prior to any long journey; the tyres should be checked when cold. Don't forget to check the spare ✱.

Use the valve cap key to make unscrewing the valve caps easier. The key is located on the inside of the tank flap.

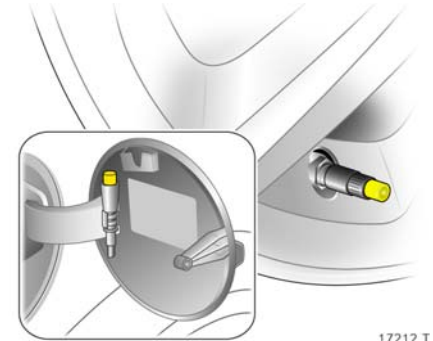

17212 T

In vehicles with tyre pressure monitoring system ✱ there is an adapter in the valve cap key. Screw adapter to valve before attaching tyre pressure gauge, see page 219.

Tyre pressure, see page 337 and the adhesive foil ✱ on the inside of the tank flap. Have adhesive foil replaced after changing to different tyre size.

Do not reduce tyre pressure when the tyres are warm. Otherwise the pressure may drop below the permissible minimum when the tyres cool down.

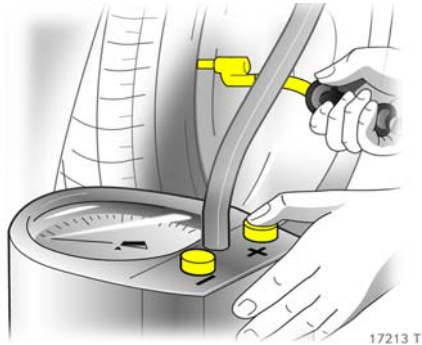

After having checked the tyre pressure, tighten the valve caps using the valve cap key.

Incorrect inflation pressures will impair safety, vehicle handling, comfort and fuel economy and will increase tyre wear.

If the pressure is too low, this can result in considerable tyre warm-up and internal damage, leading to tread separation and even to tyre blow-out at high speeds.

Hidden tyre damage is not eliminated by adjusting the inflation pressure.

Warning

Incorrect tyre pressure could lead to a flat tyre.

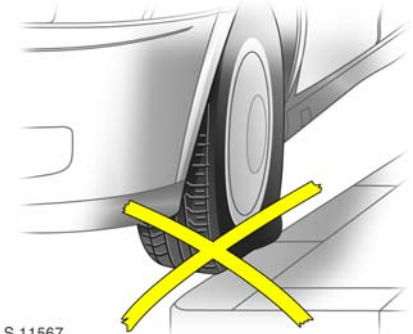

Tyre condition, wheel condition

Drive over edges slowly and at a right angle if possible. Driving over sharp edges can lead to hidden tyre damage and wheel damage which is only noticed later on.

When parking, ensure that the tyres are not pressed against the edge of the kerb.

Check tyres regularly for damage (penetrated foreign bodies, punctures, cuts, cracks, bulges in side walls). Check wheels for damage. If damage or unusual wear is found, contact a workshop.

Warning

Damage may lead to tyre blow-out.

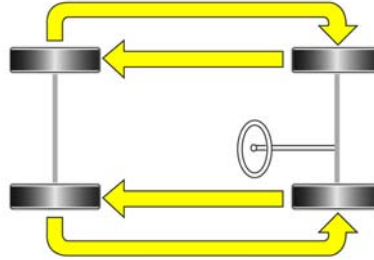

S 11568

Tread depth

Check tread depth regularly.

If wear in the front is greater than that in the rear, move the rear wheels to the front axle and vice versa.

Correct the tyre pressure.

In vehicles with a deflation detection system * or tyre pressure monitoring system * initialise system, see pages 219, 221.

For reasons of safety, tyres should be replaced when their tread depth has worn down to 2 to 3 mm (winter tyres: 4 mm).



17216 T

The legally permissible minimum tread depth (1.6 mm) has been reached when the tread has worn down as far as one of the wear indicators (TWI¹⁾). A number of wear indicators are spaced at equal intervals around the tyre within the tread. Their position is indicated by markings on the tyre sidewall.

¹⁾ TWI = Tread Wear Indicator.

General information

- The danger of aquaplaning is greater if the tyres are worn.
- Tyres age, even if they are used only very little or not at all. A spare wheel which has not been used for six years should be used only in emergencies; drive slowly when using such tyres.
- Never fit used tyres the previous history and use of which you do not know.
- So as not to impair brake cooling, use only wheel trims approved for use on your vehicle.

Tyre designations

Meanings:

e.g. **195/65 R 15 91 H**

- 195** = Tyre width in mm
- 65** = Cross-section ratio (tyre depth to width) in %
- R** = Belt type: Radial
- RF** = Type: RunFlat
- 15** = Wheel diameter in inch
- 91** = Load index
e.g. 91 corresponds to 618 kg
- H** = Speed code letter:

Speed code letters:

- Q** up to 100 mph (160 km/h)
- S** up to 112 mph (180 km/h)
- T** up to 118 mph (190 km/h)
- H** up to 130 mph (210 km/h)
- V** up to 150 mph (240 km/h)
- W** up to 168 mph (270 km/h)

Run-flat tyres (RFT) ❄

Run-flat tyres have reinforced, self-supporting sidewalls, which ensure that the tyres always have a certain amount of driveability, even when there is no pressure.

Run-flat tyres are only permitted on vehicles with ESP^{Plus} and tyre pressure monitoring system or deflation detection system.

Warning

Even the tyre pressure of run-flat tyres must be checked regularly.

Check tyre pressures at least every 14 days and prior to any long journey; the tyres should be checked when cold.

Depending on tyre manufacturer, run-flat tyres can be identified from a marking on the tyre wall. E.g. **ROF** = RunonFlat for Goodyear or **SSR** = Self Supporting Runflat Tyre for Continental.

Run-flat tyres may only be used in combination with Vauxhall-approved alloy wheels; this also applies to winter tyres.

Driving with a damaged tyre

A loss in tyre pressure is indicated by the tyre pressure monitoring system ✱ or the deflation detection system ✱.

If a tyre has no pressure, continued driving is possible

- at a speed of max. 50 mph (80 km/h)
- up to a distance of 50 miles (80 km).

 **Warning**

When driving with a flat tyre, do not exceed a speed of 50 mph (80 km/h) or a distance of 50 miles (80 km).

The vehicle will be more difficult to steer and handle and the braking distance will be longer.

Adapt driving style and speed to the conditions at hand.

Do not use a tyre repair kit.

Deflation detection system ✱, see page 218, tyre pressure monitoring system ✱, see page 219.

Winter tyres ✱

For notes on fitting new tyres, see page 225.

Limitations - see pages 230, 337.

Winter tyres improve safety at temperatures below 7 °C and should therefore be fitted on all the wheels.

The design of summer tyres means they have limited qualities for winter driving.

If the maximum permissible speed for the winter tyres is less than that of the vehicle, a notice indicating the maximum permissible speed for the tyres must be affixed within the driver's field of vision¹⁾.

If you use the spare wheel when it is fitted with a summer tyre, the vehicle's driveability may be affected, especially on slippery road surfaces. Obtain a replacement for the faulty tyre as soon as possible, and have the wheel balanced and fitted to the vehicle.

Wheel covers ✱

If the wheel trims and tyres used are not Vauxhall-approved, make sure that the tyres do not have a beaded edge, see page 227.

¹⁾ Varies from country to country on account of national regulations.

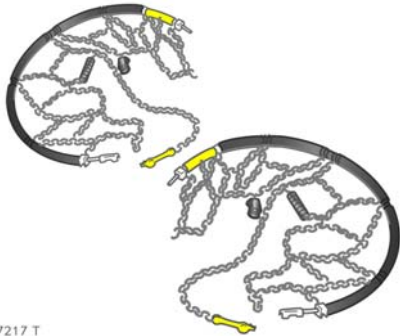

17217 T

Tyre chains ✱

Limitations and further information, see page 337.

Tyre chains are only permitted on the drive wheels (front axle). They must be fitted to the tyres symmetrically in order to achieve a concentric fit.

Always use fine mesh chains that add no more than 10 mm to the tyre tread and the inboard sides (including chain lock).

Wheel trim on steel wheels could come into contact with parts of the chain and be damaged. Remove the wheel trim, see page 252.

Tyre chains may only be used at speeds up to 30 mph (50 km/h) and, when travelling on roads that are free of snow, they may be used for brief periods only since they are subject to rapid wear on a hard road and may snap.

Temporary spare wheel ✱

Tyre chains must not be used on the temporary spare wheel. If you need to use tyre chains after suffering a flat front tyre, fit the temporary spare on the rear axle and transfer one of the rear wheels to the front axle.

For notes on the temporary spare wheel, see page 250.

Wheel changing, see page 252.

Correct the tyre pressure.

Deflation detection system ✱, see page 218, tyre pressure monitoring system ✱, see page 219.

Roof racks ✱

Warning

Disregard of these notes can lead to injuries which may be fatal. Vehicle passengers should be informed accordingly.

For safety reasons, and to prevent roof damage, we recommend use of the Vauxhall roof rack system approved for your vehicle.

Roof loads are not permitted on the Astra TwinTop.

Fasten the roof rack following the instructions that accompany the system.

Driving hints, see page 198.

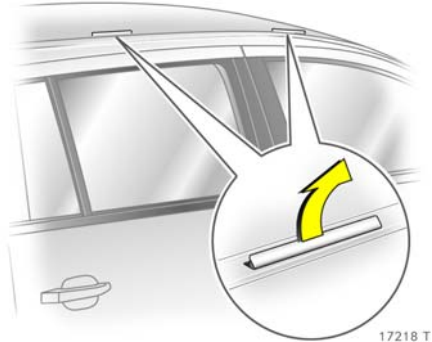

17218 T

Version without roof railing

Lift the covers from the fitting openings.

Attach roof rack at appropriate points, see enclosed roof luggage rack system instructions.

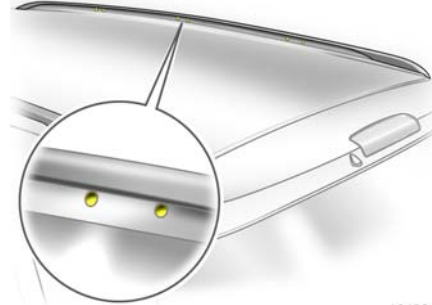

18498 T

Version with roof railing ✱

To attach the roof rack, insert mounting bolts in the bores shown in the picture, see instructions provided with the roof rack system.

Towing equipment ✱**⚠ Warning**

Disregard of these notes can lead to injuries which may be fatal. Vehicle passengers should be informed accordingly.

Only use a trailer towing device approved for the vehicle. Have a towing device fitted by workshop, who will inform you of any possible trailer load increases. They will have the instructions for fitting the device and any necessary changes to the vehicle concerning cooling, heat shields or other devices.

Observe the note on the Astra TwinTop on page 58.

Do not mount towing equipment to vehicles with Z 20 LEH¹⁾ engine.

⚠ Warning

The coupling ball bar is to be removed when not towing.

For installation dimensions of the trailer towing equipment, see pages 348, 349, 350.

¹⁾ Sales designation, see page 310 and 311.

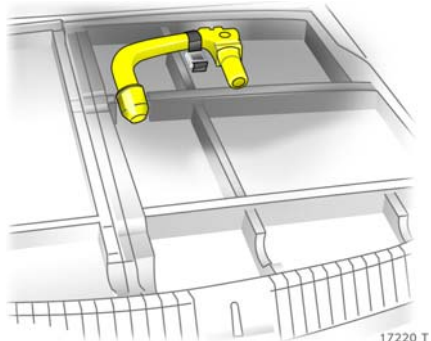

Stowage of coupling ball bar

In Hatchbacks, the coupling ball bar is in a pouch, fastened in the luggage compartment cargo box with a strap - see page 237.

In Estates, the coupling ball bar is fastened with a strap in a compartment in the spare wheel well of the luggage compartment.

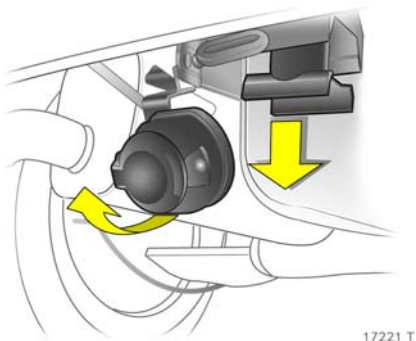

Fitting the coupling ball bar

Disengage and fold down the socket. Remove the sealing plug from the hole for the coupling ball bar and stow it in the luggage compartment.

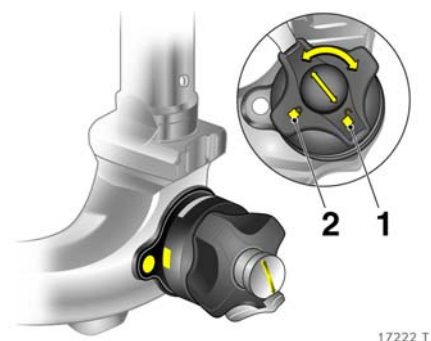

Checking the tensioning of the coupling ball bar:

- Red marking on turn knob points towards white marking on coupling ball bar.
- Gap of approx. 6 millimetres between turn knob and coupling ball bar.
- Key is in lock at position 1.

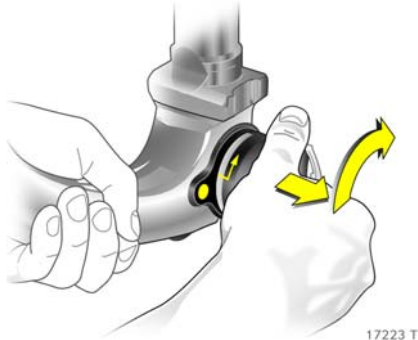

Otherwise, the coupling ball bar must be tensioned before it is inserted into the coupling housing:

- Unlock coupling ball bar (key to position 1), see Fig. 17222 T on page 234.
- Pull turn knob out and then turn it clockwise as far as it will go, see Fig. 17223 T.

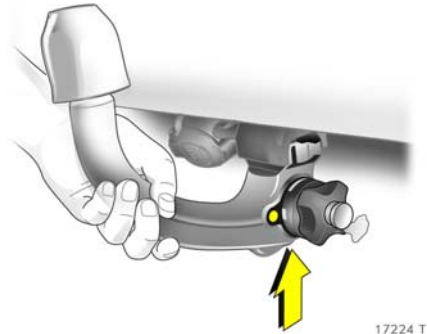

Inserting the coupling ball bar

Insert the tensioned coupling ball bar into the coupling housing and push firmly upwards until the coupling ball bar audibly engages in position.

The turn knob snaps back into its home position resting against the coupling ball bar.

⚠ Warning

Do not touch the turn knob when inserting the coupling ball bar - risk of injury.

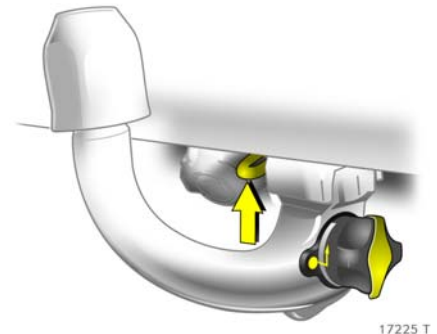

Lock coupling ball bar (key to position 2, see Fig. 17222 T on page 234). Remove key and press protective flap into position.

When the coupling ball bar is locked the turn knob can no longer be pulled out.

Important

Check that the coupling ball bar is correctly installed:

- Green marking on turn knob points towards white marking on coupling ball bar.
- No gap between turn knob and coupling ball bar.
- Coupling ball bar must be seated firmly in coupling housing.
- Coupling ball bar must be locked and key must be removed.

Warning

Towing a caravan/trailer is only permitted with a correctly mounted towbar. If the towbar cannot be correctly mounted, contact a workshop for assistance.

Eye for break-away stopping cable

In the case of caravans/trailers with brake, attach the break-away stopping cable to the eye (arrow in Fig. 17225 T).

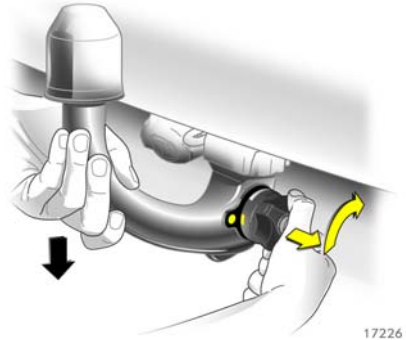

Dismounting the coupling ball bar

Unlock coupling ball bar (key to position 1, see Fig. 17222 T on page 234).

Pull out turn knob and then turn it clockwise as far as it will go. Pull coupling ball bar down out of the coupling housing and stow in compartment in the luggage compartment, see page 234.

Insert the sealing plug in the hole for the coupling ball bar. Fold away the socket, see Fig. 17221 T on page 234.

Do not use steam-jet cleaners or other high-pressure cleaners to clean the coupling ball bar.

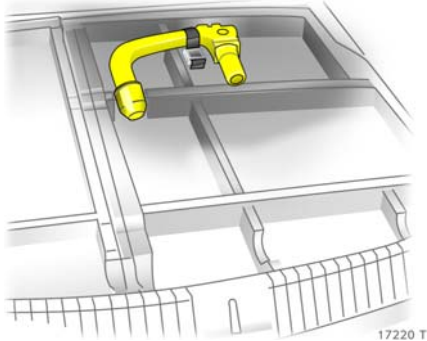

Stowage of coupling ball bar

Hatch

Stow the coupling ball bar in the pouch and fasten it in the luggage compartment cargo box with the strap.

Estate

Stow the coupling ball bar in the compartment in the spare wheel well of the luggage compartment, fastening it with the strap.

Caravan/trailer towing

Caravan and trailer loads¹⁾

The permissible caravan/trailer loads are vehicle- and engine-dependent maximum values which must not be exceeded. The actual caravan/trailer load is the difference between the actual gross weight of the caravan/trailer and the actual coupling socket load with the caravan/trailer coupled. When the caravan/trailer load is being checked, therefore, only the caravan/trailer wheels – and not the jockey wheel – must be standing on the weighing apparatus.

The permissible caravan/trailer loads for your vehicle are given in the vehicle documents. Unless otherwise stated, they are valid for gradients up to max. 12%.

The permissible caravan/trailer load should be fully utilised only by drivers who are adequately experienced in towing large or heavy caravans/trailers.

The permitted caravan/trailer load applies up to the specified incline and up to an altitude of 1000 metres above sea-level. Since engine power decreases as altitude increases because of the air becoming thinner, therefore reducing climbing ability, the permitted towing weight also decreases by 10% for every 1000 metres of additional altitude. The towing weight does not have to be reduced when driving on roads with slight inclines (less than 8%, e. g. motorways).

¹⁾ Observe national regulations.

The actual caravan/trailer load plus the actual gross weight of the towing vehicle must not exceed the maximum permitted towing weight. For example, if the permitted gross vehicle weight is utilised, the trailer/caravan load must only be used until the maximum permitted towing weight is reached. The maximum permitted towing weight is shown on the identification plate, see page 308.

Coupling socket load

The coupling socket load is the load exerted by the trailer/caravan on the coupling ball. It can be varied by changing the weight distribution when loading the trailer/caravan.

The maximum permissible coupling socket load (75 kg) is specified on the towing equipment identification plate and in the vehicle documents. Always aim for the maximum load, especially in the case of heavy caravans/trailers. The coupling socket load should never fall below 25 kg.

When measuring the coupling socket load, make sure that the drawbar of the loaded trailer/caravan is at the same height as it will be when the trailer/caravan is coupled with the towing vehicle loaded. Particularly important for trailers/caravans with tandem axle.

Rear axle load during towing

With a trailer coupled and the towing vehicle fully loaded (including all occupants), the permissible rear axle load (see identification plate or vehicle documents) may be exceeded by 65 kg and the permissible gross vehicle weight by 45 kg for the Hatch. For the Estate, the permissible rear axle load may be exceeded by 60 kg and the permissible gross vehicle weight by 30 kg. If the permissible rear axle load is exceeded a maximum speed of 60 mph (100 km/h) applies (50 mph / 80 km/h if approved for use as a commercial vehicle). If national regulations specify a lower maximum speed for vehicles towing a trailer, this must be observed.

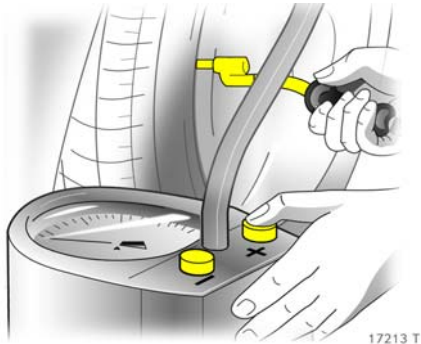

Tyre pressure

Increase the tyre pressure on the towing vehicle to the value specified for a full load, see page 337. Check the pressure of the spare wheel and caravan/trailer wheels.

Trailer Stability Assist * (TSA)

TSA monitors vehicle movements when towing a caravan or trailer. If the system detects lurching movements, engine power is reduced and the vehicle/trailer combination is selectively braked until the lurching ceases.

TSA is a function of the electronic stability programme (ESP®^{Plus}), see page 210.

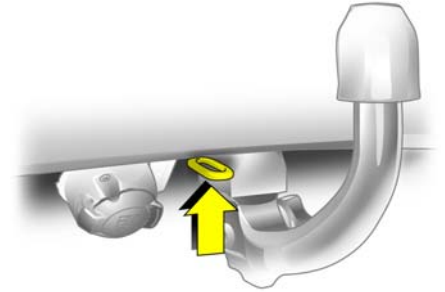

Driving characteristics, towing tips

In the case of trailers/caravans with brakes, attach breakaway stopping cable to eye.

Before attaching the trailer/caravan, lubricate the ball of the trailer/caravan towing device. However, do not lubricate the ball if a stabiliser, which acts on the coupling ball, is being used to damp hunting.

Check caravan/trailer lighting before starting to drive. The fog tail lights on the vehicle are deactivated when towing a caravan or trailer.

Caravans/trailers with LED turn signals must have a provision that makes it possible to monitor standard light bulbs.

Turn signal control indicator - see page 116.

Parking distance sensor * is deactivated when towing.

Handling is greatly influenced by the loading of the trailer/caravan. Loads should therefore be secured so that they cannot slip and be placed in the centre of the trailer/caravan if possible, i.e. above the axle.

In the case of trailers with low driving stability or caravans with a permitted gross vehicle weight of over 1300 kg (Hatch)/1200 kg (Estate), do not exceed a speed of 50 mph (80 km/h); the use of a friction-type stabiliser is highly recommended.

Do not drive faster than 50 mph (80 km/h) if possible, even in countries where higher speeds are permitted.

Make sure that you have enough room when cornering and avoid sudden manoeuvres.

If the trailer/caravan starts to sway, drive more slowly, do not attempt to correct the steering and brake sharply if necessary.

If it is necessary to apply the brakes fully, depress the brake pedal as hard as possible.

Remember that the braking distance for vehicles towing caravans/trailers with and without brake is always greater than that for vehicles not towing a caravan/trailer.

When driving downhill, the brakes are under considerably more load when towing a caravan/trailer. For this reason, drive in the same gear as if driving uphill and drive at a similar speed.

Automatic transmission * or Easytronic * in automatic mode will automatically select the driving programme with the optimum engine braking effect.

The gears can be selected manually if required.

The cooling fan is electrically operated. Its cooling power is therefore independent of the engine speed.

Since a considerable amount of heat is generated at high engine speeds and less at slower speeds, do not shift down when climbing hills whilst the vehicle is still coping with the gradient in the higher gear.

Starting on inclines

For vehicles with manual transmission, the most favourable engine speed when starting off on an incline is between 2500 and 3000 rpm for petrol engines and between 2000 and 2200 rpm for diesel engines. Hold engine speed constant, engage clutch gradually (let slip), release handbrake and open throttle. If possible, the engine speed should not drop during this procedure.

In vehicles with automatic transmission * and Easytronic * it is sufficient to apply full throttle in **D** or * in automatic mode.

Before starting off under extreme conditions (high combination weight, mountainous terrain with steep inclines), switch off all unnecessary electrical loads (e.g. heated rear window, air conditioning system *, heated front seats *).

Self-help, vehicle care

- Diesel fuel system, bleeding 241
- Bonnet 241
- Starting 242
- Starting the engine with jump leads
* 243
- Towing 244
- Warning triangle **▲*** 247
- First-aid kit (cushion) **⊕*** 247
- Spare wheel * 249
- Jack **S** * and vehicle tools * 251
- Changing wheels 252
- Tyre repair kit * 256
- Electrical system 259
- Fuses and the most important
circuits they protect 262
- Bulb replacement 269
- Halogen headlight system 269
- Xenon headlight system *,
Adaptive Forward Lighting (AFL)
system * 273
- Front turn signal lights 276
- Side turn signal lights 276
- Fog lights * 276
- Tail lights 277
- Number plate light 286
- Courtesy lights 287
- Vehicle care 289

▲ Warning

Disregard of these notes can lead to injuries which may be fatal. Vehicle passengers should be informed accordingly.

Diesel fuel system, bleeding

Never let the tank run dry! If control indicator **Ⓛ** illuminates, refuel as soon as possible. Refuel immediately if it flashes.

Restarting after running out of fuel is possible, but starting behaviour will be delayed. Turn on the ignition three times for 15 seconds each time. Then start the engine for a maximum of 40 seconds¹⁾. If it does not start, repeat the process after waiting at least 5 seconds. If the engine still does not start, contact a workshop.

¹⁾ On engines Z 17 DTH, for technical reasons only 30 seconds is possible. Sales designation see pages 310 and 311.

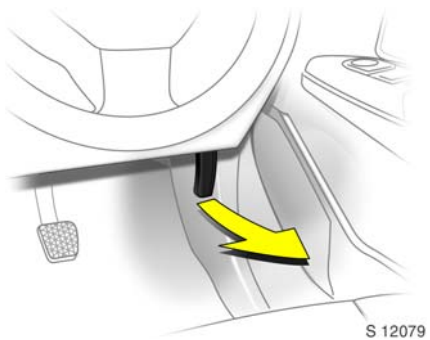

Bonnet

To open the bonnet, pull the release lever located on the driver's side below the instrument panel. The bonnet will then be unlocked and will partially open. Return release lever to its original position.

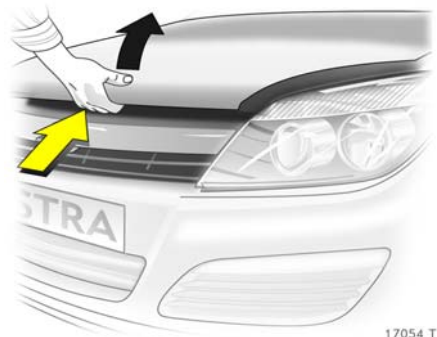

There is a safety catch on the underside of the bonnet: lift this upwards and open the bonnet.

Dirt on snow on the bonnet can slide onto the windscreen when opened and block the air intake.

Air intake, see page 174.

The bonnet is held open automatically *.

In an alternative version, the bonnet is held open by inserting the support that is located across the radiator into the small elongated hole in the underside of the bonnet.

Push support firmly into holder before closing the bonnet. Lower bonnet and allow to fall into lock.

Check that the bonnet is locked in position by pulling at its front edge. If it is not engaged, repeat the procedure.

Starting

Do not start with quick charger

This prevents damage to electronic components.

Do not start by pushing or towing

Because your vehicle is fitted with a catalytic converter, it must not be started by pushing or towing, see page 204.

Vehicle with the Open&Start system * must not be started by pushing or towing if the battery is discharged, since the steering column lock cannot be released.

The vehicle can only be started using jump leads – see following page.

Starting the engine with jump leads *

A vehicle with a discharged battery can be started using jump leads and the battery of another vehicle.

⚠ Warning

Be extremely careful when starting with jump leads. Any deviation from the following instructions can lead to injuries or damage caused by battery explosion or damage to the electrical systems of both vehicles.

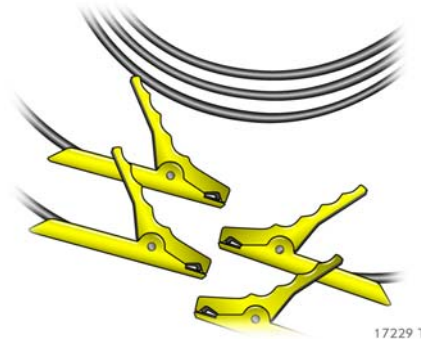

- Never expose the battery to naked flames or sparks.
- A discharged battery can freeze at temperatures of 0 °C. Defrost the frozen battery in a warm room before connecting jump leads.
- Do not allow battery fluid to come into contact with eyes, skin, fabrics or painted surfaces. The fluid contains sulphuric acid which can cause injuries and damage in the event of direct contact.
- Wear eye protection and protective clothing when handling a battery.
- Use auxiliary battery with same voltage (12 volts). Its capacity (Ah) must not be considerably less than that of the discharged battery. Voltage and capacity information can be found on the batteries.
- Use jump leads with insulated terminals and a cross section of at least 16 mm² (25 mm² for diesel engines).
- Do not disconnect the discharged battery from the vehicle.
- Switch off all unnecessary electrical consumers.
- Do not lean over the battery during jump starting.
- Do not allow the terminals of one lead to touch those of the other lead.
- The vehicles must not come into contact with each other during the jump starting process.
- Apply handbrake. Manual transmission or Easytronic * in neutral, automatic transmission * in P.

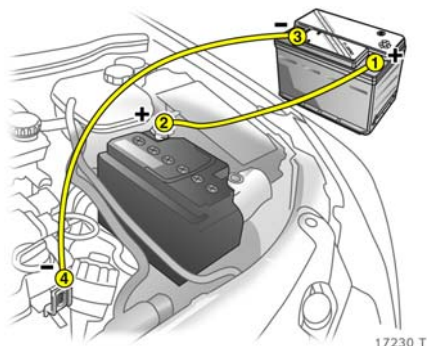

17230 T

Connect the leads in the order – see Fig. 17230 T:

1. Connect one end of the first jump lead to the positive terminal 1 of the battery providing the jump start (identified by "+" sign on battery case or terminal).
2. Connect the other end of this lead to the positive terminal 2 of the discharged battery ("+" sign).
3. Connect the first end of the other jump lead to the negative terminal 3 of the battery providing the start ("- " sign).
4. Connect the other end of the second jump lead 4 to ground on the other vehicle, e.g. engine block or screw connection in the engine suspension.

- Do not connect leads to negative terminal of discharged battery!
- The connection point should be as far away from the discharged battery as possible.
- Route the leads so that they cannot catch on rotating parts in the engine compartment.
- Start the engine of the vehicle providing the jump start.
- After 5 minutes, start the other engine. Start attempts should be made at intervals of 1 minute not last longer than 15 seconds.
- After starting, allow both engines to idle for approx. 3 minutes with the leads connected.
- In order to avoid excess voltage in the electrical system, before removing a lead, switch on an electrical consumer (e.g. light, heated rear window) in the vehicle receiving the jump start.
- Reverse above sequence exactly when removing leads.

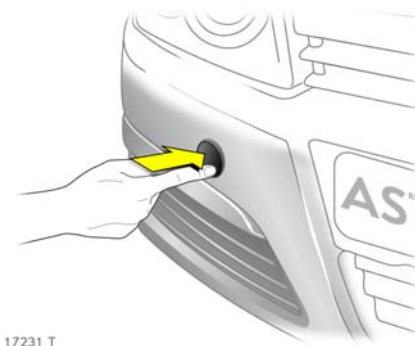

17231 T

Towing

Towing of vehicle

To open the cover concealing the towing eye socket at the front right of the vehicle: disengage the cover at the bottom and pull it off downwards.

For versions with tyre repair set ✱, the towing eye is in the stowage compartment in the boot below the loading floor cover, see page 256.

For versions with spare wheel ✱, the towing eye is in the stowage compartment for the jack ✱ and tool kit ✱ below the spare wheel, see page 251.

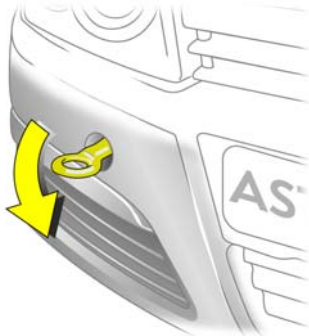

17232 T

Screw in the towing eye anti-clockwise as far as it will go until it stops in a horizontal position.

Attach a tow rope * – or better still a tow rod * – to the eye.

The towing eye must only be used for towing, not for recovering the vehicle.

Switch on ignition to release steering column lock and to permit operation of brake lights, horn and windscreen wiper.

Vehicles with the Open&Start system * must not be towed when the battery is discharged because the steering column lock cannot be released. Towing is only possible with the ignition switched on. Use jump leads to start the engine if necessary.

Manual transmission or Easytronic * in neutral, automatic transmission * in N.

Drive slowly. Do not drive jerkily. Excessive tractive force can damage the vehicle.

Warning

For braking and steering, significantly higher forces are required: brake assistance and steering assistance are effective only with the engine running.

To prevent the entry of exhaust fumes from the towing vehicle, switch on the air recirculation * and close the windows.

Vehicles with automatic transmission * should be towed facing forward only and must not be towed faster than 50 mph (80 km/h) or further than 60 miles (100 km). If the transmission is defective, or if the above speed or distance is to be exceeded, the front axle must be raised off the ground.

Contact a workshop for assistance.

On vehicles with Easytronic *, if the automatic clutch has been released manually on a power failure, towing is not possible, see page 183. In this case contact a workshop immediately for assistance.

After towing, unscrew the towing eye clockwise and refit the cover.

Towing service

Entrust your vehicle only to the towing service of your choice and obtain an estimate on towing costs before employing any towing service. In this way you avoid unnecessary costs and possible insurance problems during claim processing.

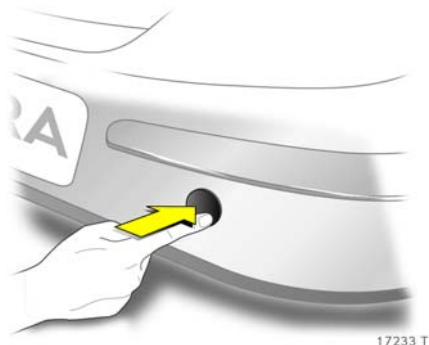

Towing another vehicle

To open the cover concealing the towing eye socket at the rear right of the vehicle: disengage the cover at the bottom and pull it off downwards.

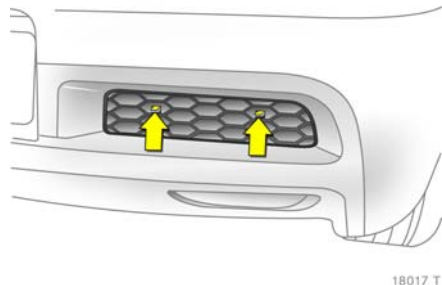

On some versions ✱: remove the cover concealing the towing eye at the rear right of the vehicle by disengaging the tabs at the bottom and pulling off the cover from the top.

For versions with tyre repair set ✱, the towing eye is in the stowage compartment in the boot below the loading floor cover, see page 256.

For versions with spare wheel ✱, the towing eye is in the stowage compartment for the jack ✱ and tool kit ✱ below the spare wheel, see page 251.

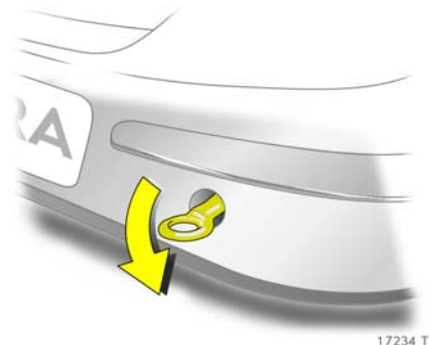

Screw in the towing eye anti-clockwise as far as it will go until it stops in a horizontal position.

Attach a tow rope ✱ – or better still a tow rod ✱ – to the eye.

The towing eye must only be used for towing, not for recovering the vehicle.

Drive slowly. Do not drive jerkily. Excessive tractive force can damage the vehicle.

After towing, unscrew the towing eye clockwise and refit the cover.

Version with cover ✱: install by inserting the bottom lugs of the cover ✱ in the bumper, folding and then press the lugs at the top into place.

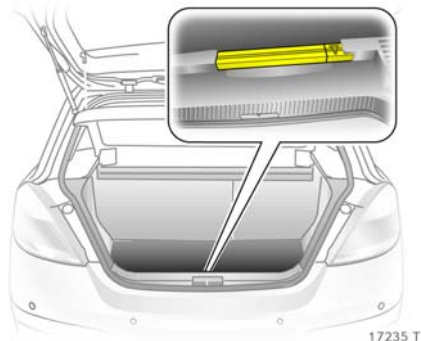

17235 T

Warning triangle ▲ *

Hatch, Astra TwinTop

Store warning triangle in rear luggage compartment wall: first fit warning triangle into recess on left and the insert in guide on right.

To remove the warning triangle, lift to the right and pull out to the right.

For vehicles with cargo box *: Lift the warning triangle with the right half of the cargo box. Pull out the warning triangle to the right.

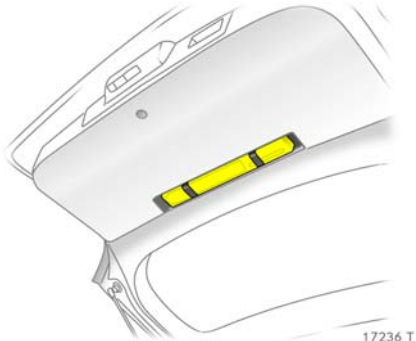

17236 T

Estate, Van

Insert the warning triangle in the retaining straps of the tailgate inner panelling.

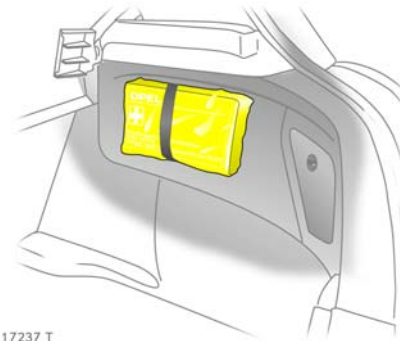

17237 T

First-aid kit (cushion) ⊕ *

Hatch

Secure the first-aid kit to the right luggage compartment wall using the retaining strap.

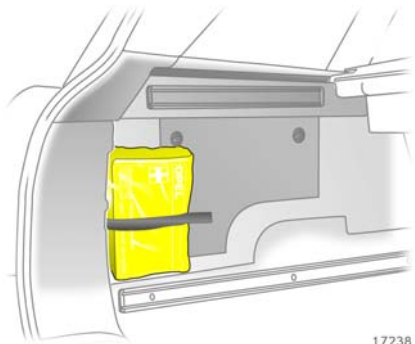

Estate

Fasten the first-aid kit (cushion) to the left luggage compartment wall with a retaining strap.

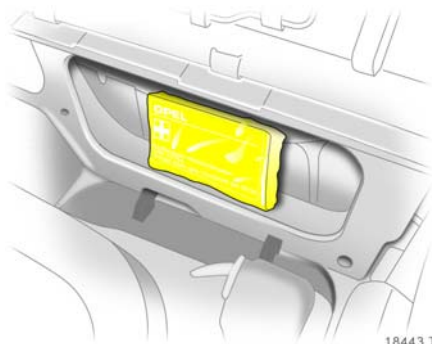

Van

Place first-aid kit in stowage compartment behind driver's seat. To open the cover, press the locking tab.

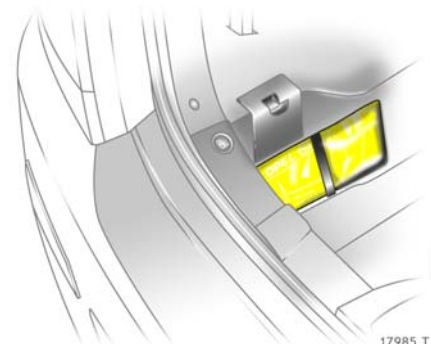

Astra TwinTop

Store the first-aid kit (cushion) in the recess behind the strap in the left luggage compartment wall.

Spare wheel ✳

Some vehicles are equipped with a tyre repair kit instead of a spare wheel – see page 256.

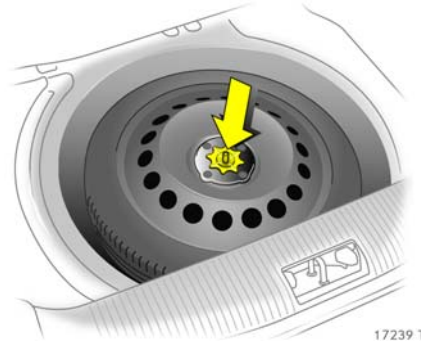
**Spare wheel placed in luggage compartment**

The spare wheel is in the luggage compartment beneath the floor cover. It is secured with a nut.

The estate also has a spacer above the securing nut.

Stowing wheels with wide tyres in the spare wheel well

The spare wheel well is not designed for all permitted tyre sizes. If a wheel wider than the spare must be stowed in the spare wheel well after changing wheels, the floor cover can be placed on the projecting wheel.

This must be taken into consideration when the luggage compartment is being loaded, particularly with the Astra TwinTop – see page 60.

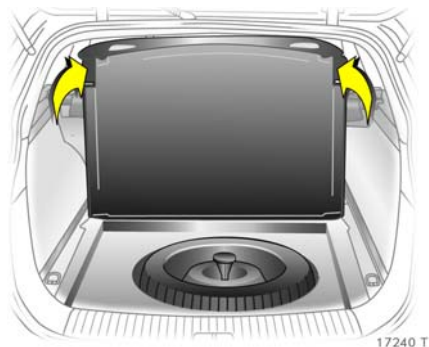

Estate

Take adapter * and hooks * from the rails * in the luggage compartment walls. Raise the rear lashing eyes and lift the floor cover to the vertical position so that it rests on the roof lining.

When closing, guide the lashing eyes through the slots in the floor cover.

Vehicles with cargo box *: Removal – see page 81.

Astra TwinTop

Accessing the spare wheel when the roof is open: Engage luggage compartment cover on the rear window frame and activate the loading aid (see page 82). Raise the floor cover in the luggage compartment.

General information

Depending on version, the spare wheel may be in the form of a temporary spare wheel *. Refer to the notes on this page and pages 232, 255, 337.

On vehicles with alloy wheels * the spare wheel may have a steel rim.

If you use winter tyres *, the spare wheel may still be fitted with a summer tyre. If you use the spare wheel the vehicle's handling may be altered. Obtain a replacement for the faulty tyre as soon as possible, and have the wheel balanced and fitted to the vehicle.

The spare wheel may have a smaller tyre and a smaller rim than the wheels mounted on the vehicle¹⁾: Using the spare wheel may alter vehicle handling. Have the defective tyre replaced as soon as possible, balance the wheel and have it mounted on the vehicle.

¹⁾ Country-specific version: The spare wheel is only to be used as a temporary spare wheel.

Notes on temporary spare wheel *

- Using a temporary spare wheel * may change the driving behaviour of the vehicle, particularly if using winter tyres *. Replace defective tyre as quickly as possible, balance wheel and fit to vehicle.
- Fit only one temporary spare wheel.
- Do not drive faster than 50 mph (80 km/h).
- Take curves slowly.
- Do not use the temporary spare wheel for a lengthy period.
- Replace temporary spare wheel with full specification wheel without delay.
- Tyre chains are not permitted on the temporary spare wheel. If tyre chains are necessary after a front wheel puncture, fit the temporary spare wheel to the rear and a rear wheel to the front. Check tyre pressure and adjust if necessary – see page 337.
- Follow temporary spare wheel instructions on pages 232, 255, 337.

Notes on directional tyres *

Directional tyres only provide maximum performance when they are mounted in the correct direction of rotation. If the tyres or spare wheel must be mounted opposing the specified direction of rotation (e.g. after changing a flat tyre), observe the following:

- Vehicle handling may change. Have the defective tyre replaced as soon as possible, and have the wheel balanced and mounted on the vehicle.
- Do not drive faster than 50 mph (80 km/h).
- Be especially careful when driving in rain and snow.

Further information on directional tyres – see page 225.

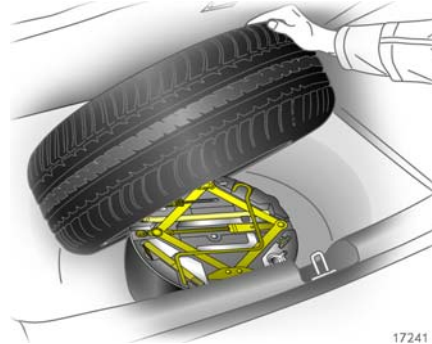

17241 T

Jack * and vehicle tools *

The jack and the vehicle tools have been specially developed for your vehicle and must only be used on that vehicle. Only use jack for changing wheels.

On Astra VXR and vehicles with wheelarch trims * or after-market trims, jacks may not be used *. The vehicle may be damaged.

Vehicles with tyre repair set *

The tool kit and tyre repair set are in a storage compartment below the floor cover in the luggage compartment.

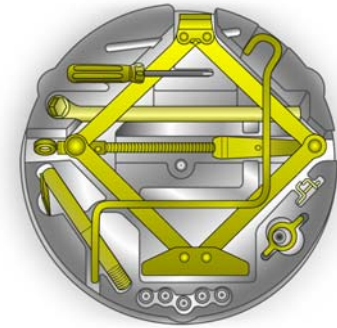

17242 T

Vehicles with spare wheel *

The jack and tool kit are in a stowage compartment in the boot below the spare wheel. Remove spare wheel, see page 249.

After use, stow away the jack and tools in the compartment as shown in Fig. 17242 T.

Astra TwinTop: The tools for emergency operation of the convertible hardtop are stowed in the glove compartment.

Changing wheels

There may be a tyre repair kit instead of a spare wheel, see page 256.

To ensure your safety, make the following preparations and observe the following information when changing wheels:

- Park the vehicle on a level, firm and non-skid surface.
- Switch on hazard warning lights, apply handbrake, automatic transmission * – selector lever in **P**, manual transmission or Easytronic * – engage 1st or reverse gear.
- Correctly set up the warning triangle *. Warning triangle, see page 247.
- Remove spare wheel from luggage compartment, see page 249.
- Before raising the vehicle, set the front wheels to the straight-ahead position.
- On the Astra TwinTop, the roof must be closed before the vehicle is raised.

- Never change more than one wheel at once.
- Block the wheel diagonally opposite the wheel to be changed by placing wedge blocks or equivalent in front and behind the wheel.
- Use the jack * only to change wheels.
- If the ground on which the vehicle is standing is soft, a solid board (max. 1 cm thick) should be placed under the jack *. Using a thicker board could damage the jack * and the vehicle.

- No people or animals may be in the vehicle when it is jacked-up.
- Never crawl under a jacked-up vehicle.
- Do not start or run the engine while the vehicle is on the jack.
- Before inserting the wheel bolts when changing wheels, lightly grease the cone of each bolt. For this reason, carry some conventional grease.



17243 T

1. Prise off the wheel trim using the hook included with the vehicle tools *. For vehicle tools, see page 251.

For wheel trims with visible wheel bolts *: The trim can remain on the wheel. Do not remove the retaining washers * on the wheel bolts.



17244 T

Alloy wheels *: Disengage the wheel bolt caps with a screwdriver and remove. Protect the wheel by inserting a soft cloth between the screwdriver and alloy wheel.

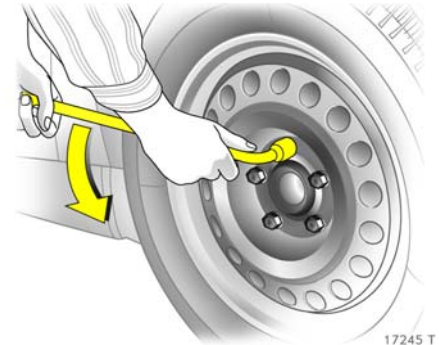

17245 T

2. Turn wheel bolts half a turn using the wheel bolt wrench *, pushing the wrench * on as far as possible.

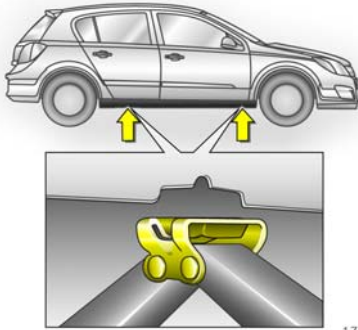

17246 T

3. The location of each jacking point * is indicated by a mark on the bottom edge of the vehicle.

On Astra VXR and vehicles with wheelarch trims * or after-market trims, jacks may not be used *. The vehicle may be damaged.

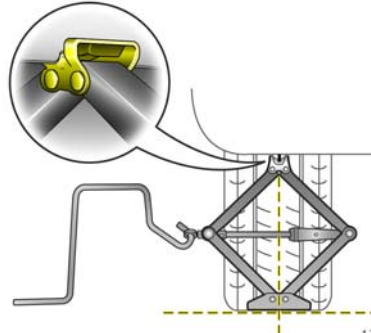

17247 T

4. Before positioning the jack *, set it to the necessary height by rotating the eye by hand. Position the jack * at the front or rear so that the jack claw spans the vertical base and grips in the recess in the vertical base. Make sure it is properly positioned.

The jack base must be on the ground directly below the jacking point in a manner that prevents it from slipping.

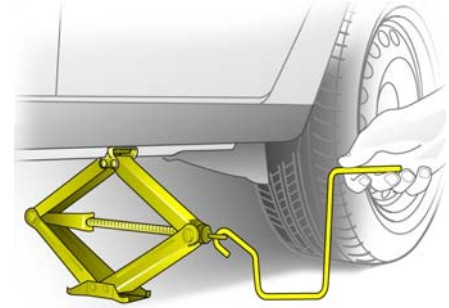

17248 T

Attach crank to eye of threaded rod and turn crank to raise vehicle.

If this is not the case, carefully lower the vehicle immediately and reposition the jack.

5. Unscrew wheel bolts and wipe clean with a cloth. Then apply a light coating of grease to the wheel bolts. Do not grease the thread of the bolts. Do not put the wheel bolts down in a location where they may become soiled.

If the wheel bolts have retaining washers *, they must not be removed.

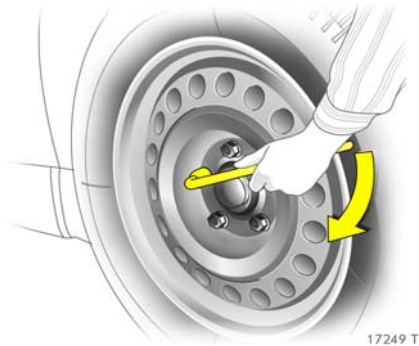

6. Change the wheel. Notes on spare wheel, see page 249, notes on temporary spare wheel, see page 250.
7. Screw in wheel bolts and tighten slightly, inserting the wheel bolt wrench * as far as possible.
8. Lower vehicle.
9. Tighten wheel bolts crosswise, putting on wheel bolt wrench * as far as possible.

10. Before refitting the wheel trim, clean the wheel around the retaining clips. Valve symbol * on back of wheel trim must point towards valve on wheel.

Align and refit wheel trim or wheel bolt caps *.

Alloy wheels *: Align and refit wheel bolt caps *.

11. Stow replaced wheel, tools and warning triangle * in luggage compartment, see pages 247 to 251.
12. Check the tyre pressure of the newly fitted wheel. Adjust as necessary.

13. Have the tightening torque of the wheel bolts on the new wheel checked on the vehicle using a torque wrench as soon as possible and, if necessary, corrected. Tightening torque, see page 337.

14. Replace the faulty tyre on the wheel that was removed.

15. Replace temporary spare wheel * with a full specification wheel without delay.

16. Initialise the deflation detection system * or tyre pressure monitoring system *, see pages 219, 221.

Tyre repair kit *

Minor damage to the tyre tread or side wall, e.g. from foreign bodies, can be repaired using the tyre repair kit (does not apply to run-flat tyres).

Do not remove the foreign body from the tyre.

Tyre damage exceeding 4 mm or damage to the wheel rim cannot be repaired with the tyre repair kit.

Warning

Vehicles with insufficient or no tyre pressure can lead to invisible damage to the tyre. This damage cannot be repaired with the tyre repair kit. Park the vehicle and contact a workshop for assistance.

Important information, see page 259.

In the event of a flat tyre:

- Switch on hazard warning lights, apply handbrake, automatic transmission * – selector lever in **P**, manual transmission or Easytronic * - engage 1st or reverse gear.
- Correctly set up the warning triangle *, warning triangle, see page 247.



17250 T

The tyre repair kit is in a compartment under the floor cover luggage compartment.

1. Take the pouch with the tyre repair kit from the compartment. Carefully remove the components from the pouch.
2. Remove the compressor.

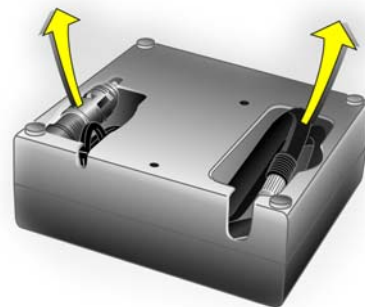

17251 T

3. Remove the electrical connection cable and air hose from the stowage compartments on the underside of the compressor.



17252 T

4. Screw the compressor air hose to the connection on the sealant bottle.
5. Fit the sealant bottle into the retainer on the compressor.

Set the compressor near the tyre in such a way that the sealant bottle is upright.

6. Remove the valve cap from the defective tyre.

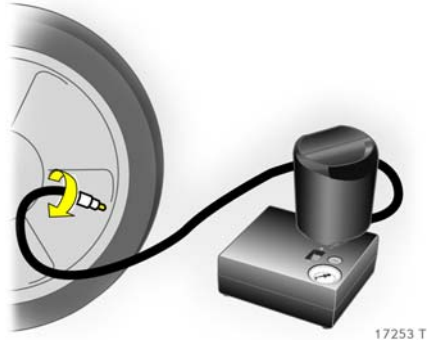

17253 T

7. Screw the filler hose to the tyre valve.
8. The switch on the compressor must be set to **O**.
9. Connect the compressor plug to the accessory socket or cigarette lighter socket. Accessory socket, see page 107.
To avoid discharging the battery, we recommend running the engine.



17254 T

10. Set the rocker switch on the compressor to **I**. The tyre is filled with sealant.
11. While the sealant bottle drains (approx. 30 seconds) the pressure indicator on the compressor briefly points to 6 bar. Pressure then sinks again.
12. All of the sealant is pumped into the tyre. Afterwards, the tyre is filled with air.
13. The prescribed tyre pressure, see page 337, should be reached within 10 minutes. Switch off the compressor when the correct pressure is obtained.

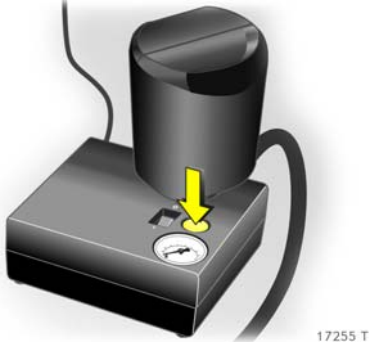

17255 T

If the specified tyre pressure is not reached within 10 minutes, remove the tyre repair kit. Move the vehicle through one tyre rotation, approx. 2 metres, in either direction. Reconnect the tyre repair kit and continue the filling process for 10 minutes. If the specified tyre pressure is still not reached, the tyre is too badly damaged. Park the vehicle and contact a workshop.

- Drain excess tyre pressure with the button over the pressure indicator.
- Do not run the compressor for more than 10 minutes - see "Important information" on page 259.
- 14. Detach the tyre repair kit. Screw the filler hose to the free connection on the sealant bottle. This prevents sealant leakage. Stow the tyre repair kit in the luggage compartment.
- 15. Wipe away any sealant spill with a cloth.
- 16. Disassemble the warning triangle * and store in luggage compartment, see page 247.
- 17. The enclosed sticker shows the maximum permitted speed at which the tyre repair may be used. Apply sticker in the driver's field of vision.
- 18. Continue driving immediately to allow the sealant to distribute evenly throughout the tyre. Stop after approx. 6 miles/10 km (no more than 10 minutes) and check tyre pressure. Screw the compressor air hose directly onto the tyre valve (see Fig. 17256 T).

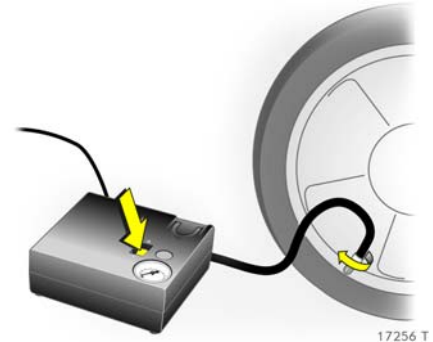

17256 T

If tyre pressure is more than 1.3 bar, adjust to the prescribed value. Repeat the procedure until there is no more pressure loss.

If the tyre pressure has fallen below 1.3 bar, the vehicle may no longer be used. Contact a workshop.

- 19. Stow the tyre repair kit in the luggage compartment, see page 256.

Important Information

 Warning
Do not drive faster than 50 mph (80 km/h).
Do not use the temporary spare wheel for a lengthy period.
Steerability and driving behaviour may be impaired.

The driving comfort of the repaired tyre is severely affected, therefore have this tyre replaced.

If the compressor makes abnormal noises or heats up greatly, switch it off for at least 30 minutes.

The integrated safety valve opens at a pressure of 7 bar.

Protect the compressor from moisture and rain.

The sealant can only be stored for approx. 4 years. After this time, the sealing properties can no longer be guaranteed. Heed the expiration date on the sealant bottle.

The sealant bottle can only be used once. Replace a used sealant bottle.

The compressor and sealant can be used from approx. -30 °C.

Dispose of a used tyre repair kit in accordance with applicable legislation.

The adapters supplied * can be used to inflate other items e.g. footballs, air mattresses, inflatable dinghies etc.

They are located on the underside of the compressor. To remove, screw on compressor air hose and withdraw adapter.

When using the tyre repair set, no consumers may be connected to the front accessory socket.

Electrical system

 Warning
Electronic ignition systems generate very high voltages. Do not touch the ignition system; high voltage can be fatal.

Fuses

The vehicle has two fuseboxes: one behind a cover on the left side of the luggage compartment and one in the front left of the engine compartment.



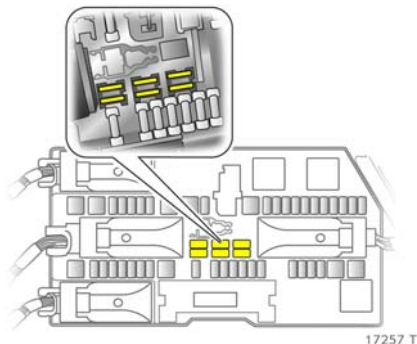

17257 T

We recommend carrying a complete set of fuses.

Put spare fuses in the provided location in the fusebox in the luggage compartment. Open cover, see page 262.

Before replacing a fuse, turn off the respective switch and the ignition.

A blown fuse (see figures to the right) can be recognised by its melted wire. Do not install a new fuse until the cause of the fault has been remedied.

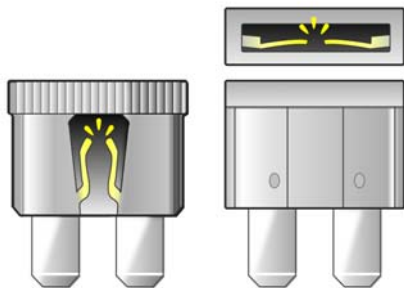

17259 T

Different versions of fuses are used.

Fuse, colour	Fuse, rating
Brownish yellow	5 A
Brown	7.5 A
Red	10 A
Blue	15 A
Yellow	20 A
Transparent	25 A
Green	30 A



17260 T

Fuse, colour	Fuse, rating
Blue	20 A
Transparent	25 A
Pink	30 A
Green	40 A

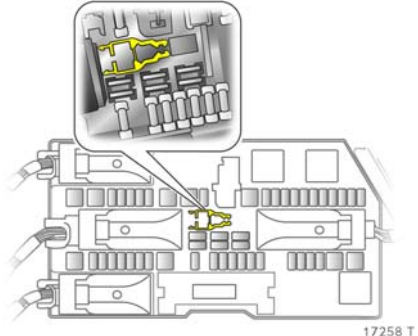

17258 T

There is a fuse extractor in the luggage compartment fusebox to facilitate replacement of fuses – see Fig. 17258 T for an example.

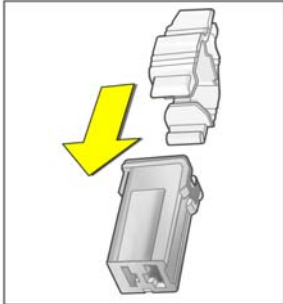
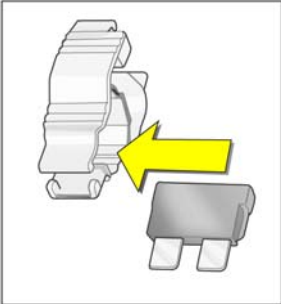
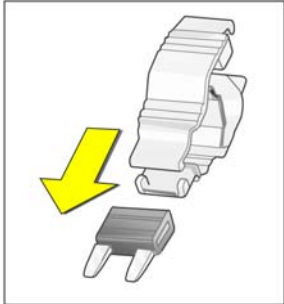

18449 T

Place the fuse extractor on the various types of fuse from the top or side, and withdraw fuse.

Only fit fuses of the specified current rating. Each fuse has its current rating written on it, in addition the ratings are colour coded.

Fuses and the most important circuits they protect

Fusebox in luggage compartment

Depending on the equipment version, there are two different fuseboxes in the luggage compartment for differing electrical circuits.

■ Version **A** – see Fig. 18504 T on page 263.

■ Version **B** – see Fig. 17958 T on page 264.

The Astra TwinTop always has version **B**.

Spare fuses, fuse extractor, see page 259.

The fusebox is located on the left side of the luggage compartment behind a cover.

Do not store any objects behind the cover.

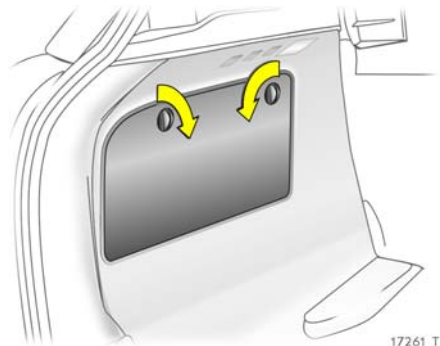

5-door Hatch, Estate, Van

To open, turn both catches with a coin and fold cover down.

3-door Hatch

To open, fold the cover upwards.

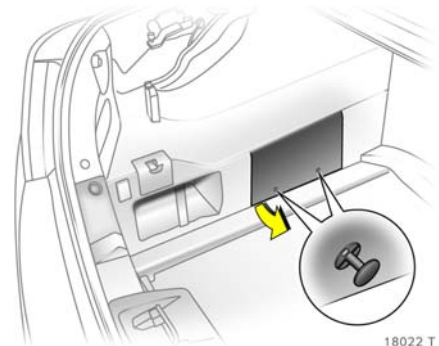

Astra TwinTop

To open, pull the two knobs, remove the clips and fold the cover upwards.

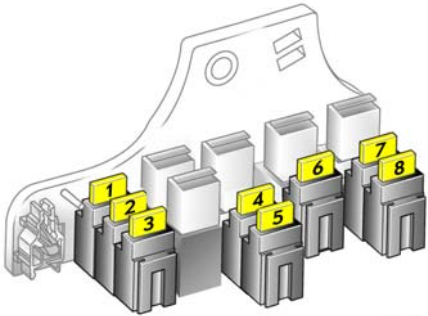

18504 T

Fusebox, version A

Some functions are protected by several fuses. To replace a fuse, pull off its protective cap.

No.	Circuit	Rating
1	Fog lights	15 A
2	–	–
3	Luggage compartment socket	15 A
4	Reverse lights	7.5 A
5	Electric windows, rear	30 A
6	Air conditioning system	10 A
7	Electric windows, front	30 A
8	Heated exterior mirrors	7.5 A

Fusebox, version B

Some functions are protected by several fuses.

No.	Circuit	Rating
1	Electric windows, front	25 A
2	–	–
3	Instruments	7.5 A
4	Heating, air conditioning system, climate control system	5 A
5	Airbags	7.5 A
6	–	–
7	–	–
8	–	–
9	–	–
10	–	–
11	Heated rear window	25 A
12	Rear screen wiper	15 A

No.	Circuit	Rating
13	Parking distance sensor	5 A
14	Heating, air conditioning system	7.5
15	–	–
16	Seat occupancy recognition, Open&Start system	5 A
17	Rain sensor, air quality sensor, tyre pressure monitoring system, interior mirror	5 A
18	Instruments, switches	5 A
19	–	–
20	CDC	10 A
21	Heated exterior mirrors	7.5 A
22	Sunroof	20 A
23	Electric windows, rear	25 A

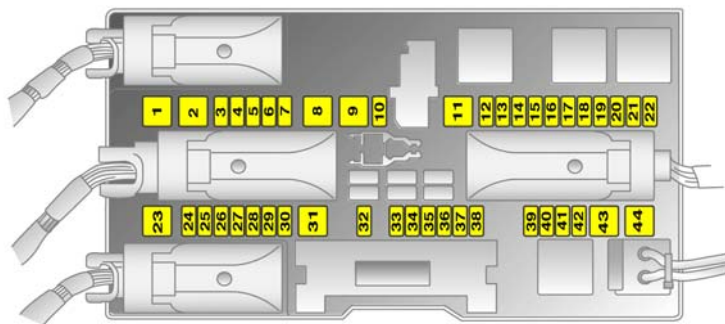

17958 T

No. Circuit	Rating
24 Diagnostics plug	7.5 A
25 –	–
26 Electrically retractable exterior mirrors	7.5 A
27 Ultrasonic sensor, Vauxhall alarm system	5 A
28 –	–
29 Cigarette lighter, front socket	15 A
30 Rear socket	15 A
31 –	–

No. Circuit	Rating
32 –	–
33 Open&Start system	15 A
34 Sunroof, TwinTop	25 A
35 Rear socket	15 A
36 Towing equipment	20 A
37 –	–

No. Circuit	Rating
38 Central locking system, terminal 30	25 A
39 Seat heater (left)	15 A
40 Seat heater (right)	15 A
41 –	–
42 –	–
43 –	–
44 –	–

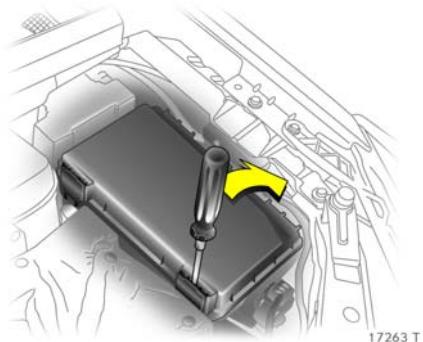

Fusebox in engine compartment

The fusebox is at the front left side of the engine compartment.

⚠ Warning
Turn off engine before opening engine compartment fusebox; risk of injury, see page 297.

To open the cover, release the catch by inserting a screwdriver into the opening as far as it will go and swivelling it to the side. Open the cover upwards and remove.

Depending on the equipment version, there are two different fuse layouts for the engine compartment fusebox, handling different electrical circuits:

- If the luggage compartment fusebox is version **A** - see Fig. 18504 T on page 263 - the fuse layout in the engine compartment is version **A** – see next column.
- If the luggage compartment fusebox is version **B** - see Fig. 17958 T on page 264 - the fuse layout in the engine compartment is version **B** - see page 267.

The Astra TwinTop always has version **B**.
Spare fuses, fuse extractor, see page 259.

Fuse layout, version A

Some functions are protected by several fuses.

No.	Circuit	Rating
1	ABS	20 A
2	ABS	30 A
3	Interior fan climate control system	30 A
4	Interior fan, heating, air conditioning system	30 A
5	Radiator fan 1 ¹⁾	30 A 40 A

¹⁾ Different ratings depending on engine and equipment level.

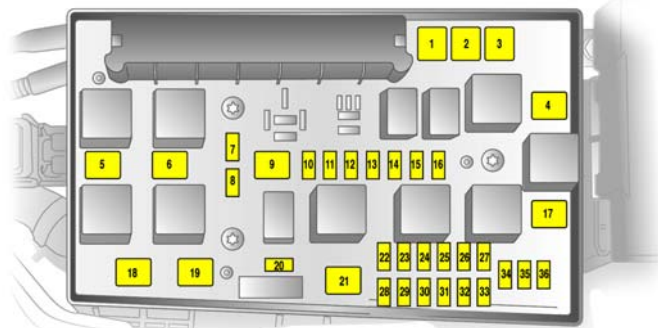

17264

No.	Circuit	Rating
6	Radiator fan 2 ¹⁾	20 A 30 A 40 A
7	Central locking system	20 A
8	Windscreen wash system, tailgate	10 A
9	Heated rear window, heated exterior mirrors	30 A
10	Diagnostics plug	7.5 A
11	Instruments	7.5 A
12	Mobile telephone, digital radio, Twin Audio, display	7.5 A
13	Courtesy light	5 A

No.	Circuit	Rating
14	Windscreen wiper	30 A
15	Windscreen wiper	30 A
16	Horn, ABS, brake light switch, air conditioning system	5 A
17	Diesel filter or air conditioning system	25 A 20 A
18	Starter	25 A
19	–	–
20	Horn	15 A

No.	Circuit	Rating
21	Engine electronics	20 A
22	Engine electronics	7.5 A
23	Headlight range adjustment	5 A
24	Fuel pump	15 A
25	–	–
26	Engine electronics	10 A
27	Heating, air conditioning system, air quality sensor	7.5 A
28	–	–
29	Power steering	5 A
30	Engine electronics	10 A
31	Rear screen wiper	15 A
32	Brake light switch	5 A
33	Headlight range adjustment, light switch, clutch switch, instrument assembly, driver's door module	5 A
34	Control unit, steering column module	7.5 A
35	Infotainment system	20 A
36	Cigarette lighter, front socket	15 A

¹⁾ Different ratings depending on engine and equipment level.

Fuse layout, version B

Some functions are protected by several fuses.

No.	Circuit	Rating
1	ABS	20 A
2	ABS	30 A
3	Interior fan climate control system	30 A
4	Interior fan, heating, air conditioning system	30 A
5	Radiator fan 1 ¹⁾	30 A 40 A
6	Radiator fan 2 ¹⁾	20 A 30 A 40 A

No.	Circuit	Rating
7	Windscreen wash system	10 A
8	Horn	15 A
9	Headlight wash system	25 A
10	–	–
11	–	–
12	–	–
13	Fog lights	15 A
14	Windscreen wiper	30 A
15	Windscreen wiper	30 A

No.	Circuit	Rating
16	Electronics control units, Open&Start system, ABS, brake light switch, TwinTop	5 A
17	Diesel filter heating	25 A
18	Starter	25 A
19	Transmission electronics	30 A
20	Air conditioning system	10 A
21	Engine electronics	20 A
22	Engine electronics	7.5 A
23	Adaptive Forward Lighting, headlight range adjustment	10 A

¹⁾ Different ratings depending on engine and equipment level.

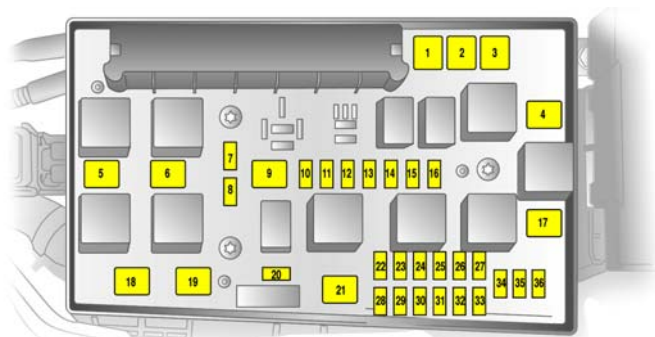

17264 T

No.	Circuit	Rating
24	Fuel pump	15 A
25	Transmission electronics	15 A
26	Engine electronics	10 A
27	Power steering	5 A
28	Transmission electronics	5 A
29	Transmission electronics	7.5 A
30	Engine electronics	10 A

No.	Circuit	Rating
31	Adaptive Forward Lighting, headlight range adjustment	10 A
32	Brake system, air conditioning system, clutch switch	5 A
33	Adaptive Forward Lighting, headlight range adjustment, light switch	5 A
34	Control unit, steering column module	7.5 A
35	Infotainment system	20 A
36	Mobile telephone, digital radio, Twin Audio, display	7.5 A

Bulb replacement

Before replacing a bulb, switch ignition off and turn appropriate switch off.

Only hold new bulb at base! Do not touch the bulb glass with bare hands, otherwise fingerprints on the glass evaporate.

Residue builds up on the reflector eventually resulting in a dull reflector. Inadvertently stained bulbs may be cleaned with a clean lint-free cloth, using alcohol or white spirits.

The replacement bulb must be in accordance with the data on the base of the defective bulb. Do not exceed wattage given on bulb base.

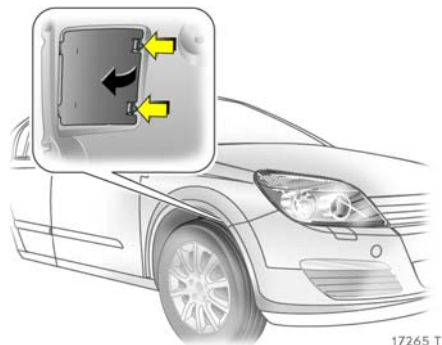

17265 T

The bulbs of the front outer lights are replaced through openings in the front wheel arches: turn appropriate wheels to gain access, release catch and remove cover.

Headlight aiming

We recommend that headlight adjustment be carried out by a workshop, who will have special equipment.

On headlight adjustment, the manual headlight range adjustment * must be set to 0.

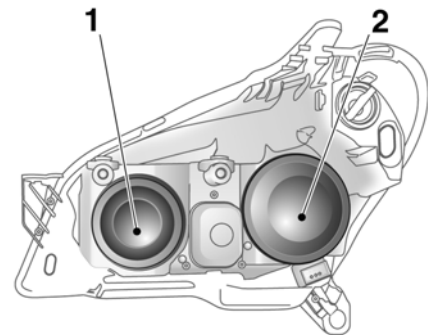

17266 T

Halogen headlight system

Headlights with separate systems for main beam 1 (inner bulbs) and dipped beam 2 (outer bulbs).

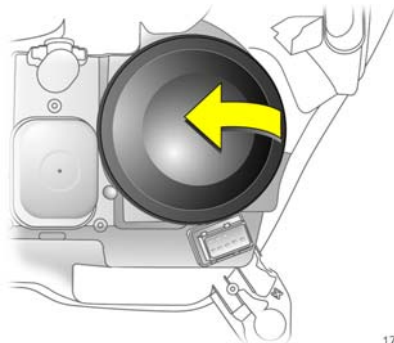

17267 T

Dipped beam

1. Replace bulb through the opening in the front wheel arch: turn appropriate wheel to gain access, release catch and remove cover, see page 269.
2. Remove headlight protective cover.

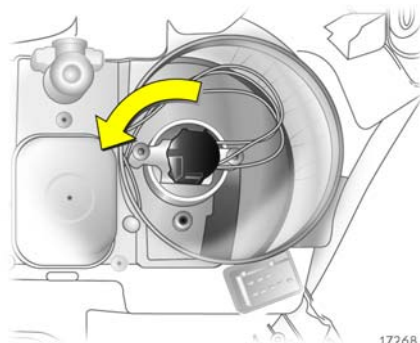

17268 T

3. Rotate left bulb holder and disengage.

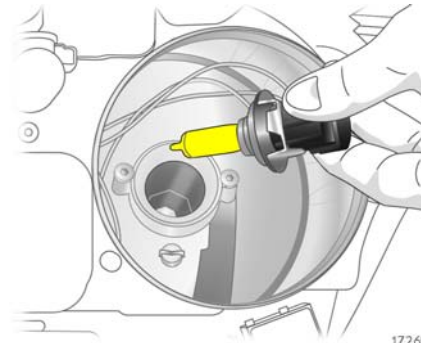

17269 T

4. Remove the bulb holder with bulb from the reflector.

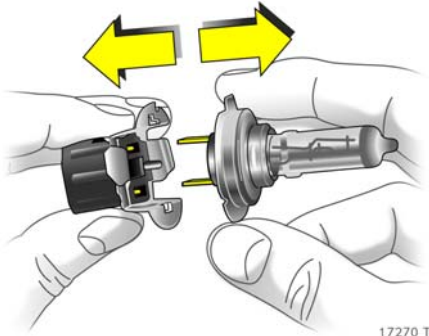

- 5. Detach bulb from bulb holder.
- 6. Insert new bulb into bulb holder, without touching the glass.
- 7. Insert new bulb so that the two lugs on the bulb holder engage in the recesses in the reflector.
- 8. Rotate bulb holder to right as far as it will go.
- 9. Place headlight protective cover in position and close.
- 10. Position cover on opening in wheel arch and engage.

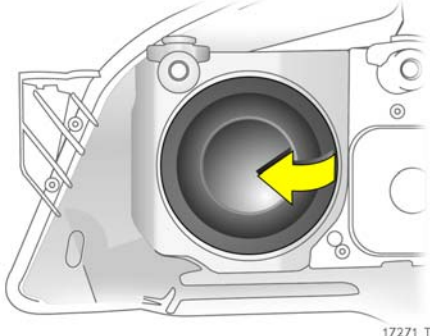

Main beam

- 1. Open bonnet and engage support.
- 2. Replace bulbs from engine compartment out.

To replace the bulb on the right-hand side, remove the air hose from the air filter.

To replace the bulb on the left-hand side, remove the plug from the fusebox.
- 3. Remove headlight protective cover.
- 4. Detach plug connector from bulb.

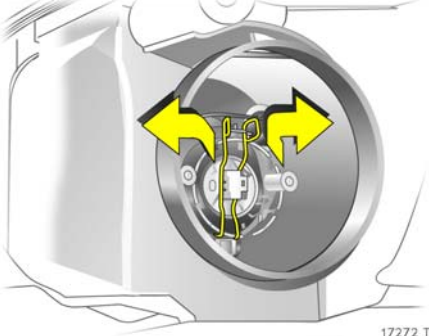

- 5. Disengage spring clip from retainer by pressing forward and then swing downward.
- 6. Remove bulb from reflector housing.
- 7. When fitting a new bulb, engage the lugs in the recesses on the reflector without touching the glass.

- Engage spring wire clip, plug connector onto bulb.
- Place headlight protective cover in position and close.

After bulb replacement on the right-hand side, re-attach air hose to air filter and engage.

After bulb replacement on the left-hand side, reconnect the fusebox plug and engage.

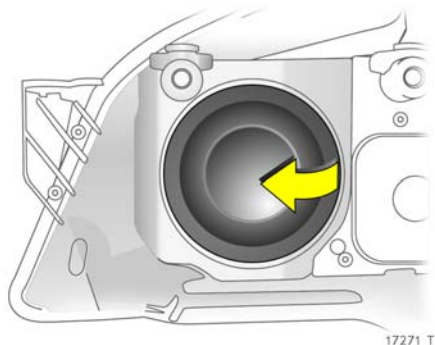

Parking lights

- Open bonnet and engage support.
- Replace bulbs from engine compartment out.

To replace the bulb on the right-hand side, remove the air hose from the air filter.

To replace the bulb on the left-hand side, remove the plug from the fusebox.
- Remove main beam headlight protective cover.

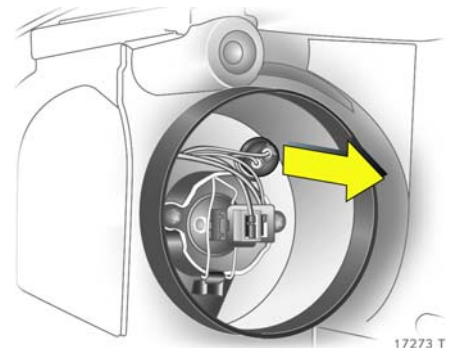

- Remove parking light socket from reflector.

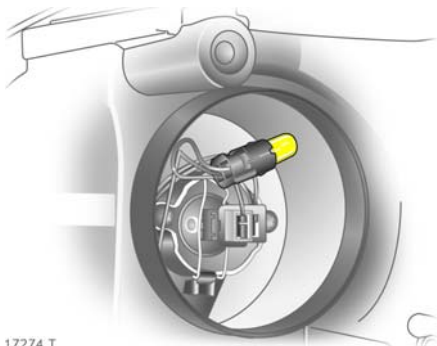

17274 T

5. Remove bulb from socket.
6. Insert new bulb, without touching the glass.
7. Insert holder in reflector. Place headlight protective cap in position and close.

After bulb replacement on the right-hand side, re-attach air hose to air filter and engage.

After bulb replacement on the left-hand side, reconnect the fusebox plug and engage.

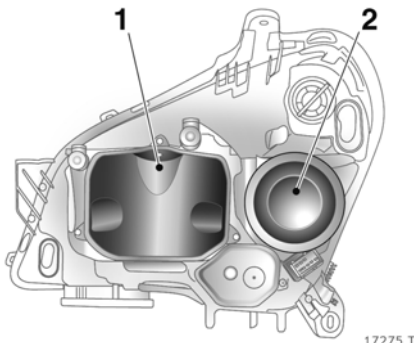

17275 T

Xenon headlight system ✳, Adaptive Forward Lighting (AFL) system ✳

Headlights with separate systems for dipped beam 1 (inner bulbs) and main beam 2 (outer bulbs).

Dipped beam

Warning

Dipped beam works with a very high electrical voltage. Do not touch, risk of injury. Have a workshop replace the bulb.

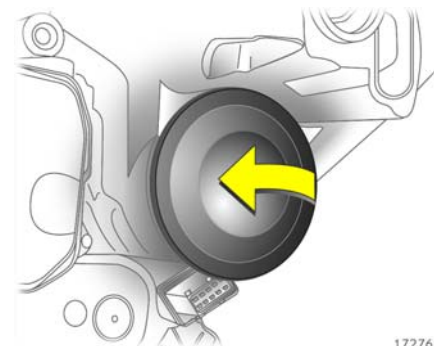

17276 T

Main beam

1. Replace bulb through the opening in the front wheel arch: turn appropriate wheel to gain access, release catch and remove cover, see page 269.
2. Remove headlight protective cover.

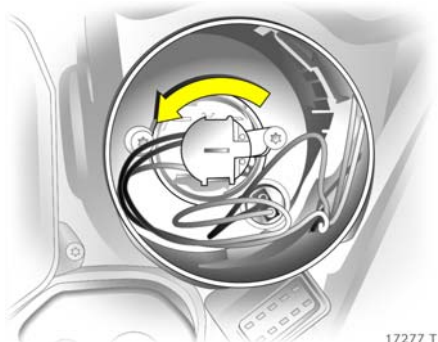

3. Rotate left bulb holder and disengage.

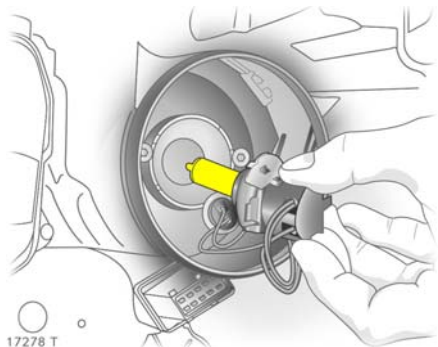

4. Remove the bulb holder with bulb from the reflector.

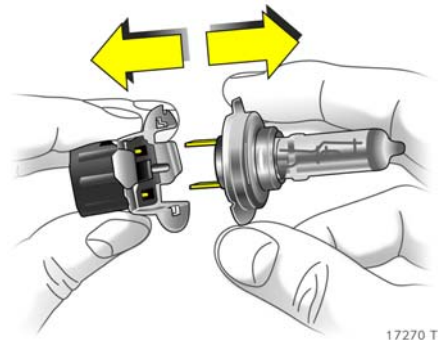

5. Detach bulb from bulb holder.
6. Insert new bulb into bulb holder, without touching the glass.
7. Insert new bulb so that the two lugs on the bulb holder engage in the recesses in the reflector.
8. Rotate bulb holder to right as far as it will go.
9. Place headlight protective cover in position and close.
10. Position cover on opening in wheel arch and engage.

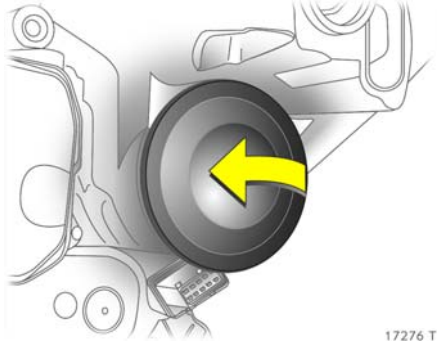

Parking lights

1. Open bonnet and engage support.
2. Replace bulb through the opening in the front wheel arch: turn appropriate wheel to gain access, release catch and remove cover, see page 269.
3. Remove main beam headlight protective cover.

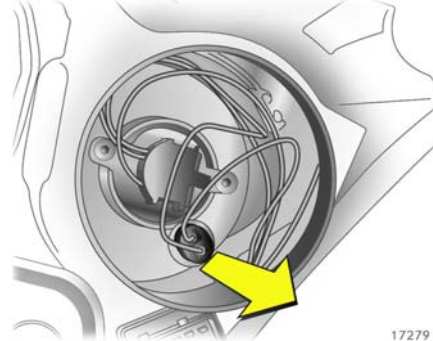

4. Remove parking light socket from reflector.

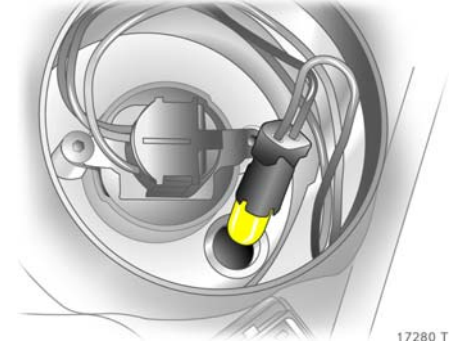

5. Remove bulb from socket.
6. Insert new bulb, without touching the glass.
7. Insert holder in reflector. Place headlight protective cap in position and close.
8. Position cover on opening in wheel arch and engage.

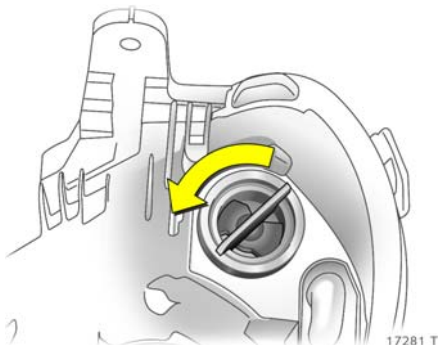

Front turn signal lights

1. Open bonnet and engage support.
2. Replace bulb through the opening in the front wheel arch: turn appropriate wheel to gain access, release catch and remove cover, see page 269.
3. Rotate bulb holder to left and disengage.

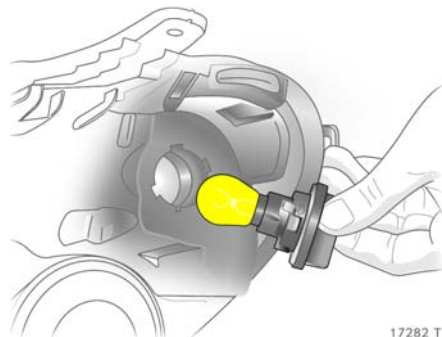

4. Push bulb into socket slightly, rotate left and remove.
5. Insert new bulb, without touching the glass.

6. Insert light holder in reflector, rotate clockwise and engage in position.
7. Position cover on opening in wheel arch and engage.

Side turn signal lights

Have the bulb changed by a workshop.

Fog lights *

Have the bulb changed by a workshop.



Tail lights

Hatch 5-door

1. To replace bulbs on the right side, use a coin to open the lock as indicated in the Fig. and fold the cover down.

To replace bulbs on the left side, use a coin to turn both locks (see Fig. 17261 T on page 262) and fold the cover down.

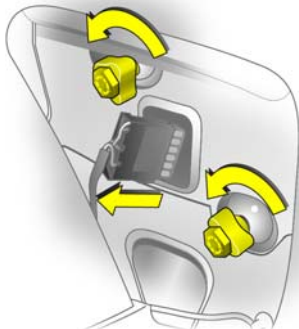

- 2. Detach plug connector from bulb holder.
- 3. Hold outside of bulb housing, loosen fastening nuts with wheel bolt wrench * and unscrew by hand. Wheel bolt wrench *, see vehicle tools on page 251.

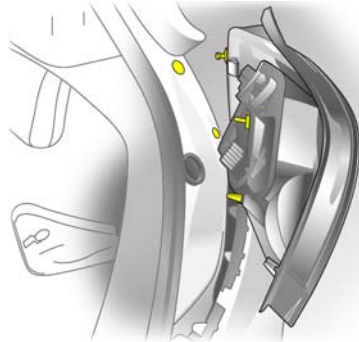

- 4. Detach bulb housing towards the rear.

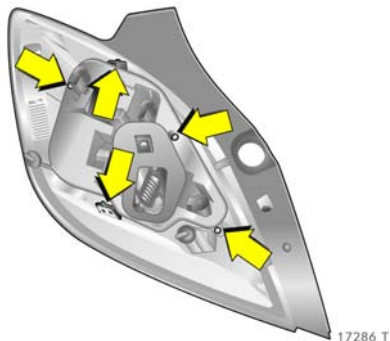

5. Unscrew three screws using a screwdriver (vehicle tools, see page 251). Press locking tabs on outside of bulb holder inward and remove the bulb holder.

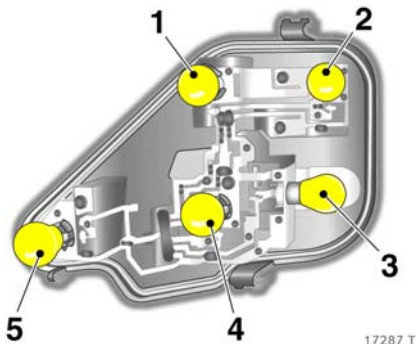

Bulbs in bulb carrier:

- 1 = Reversing light
- 2 = Flasher
- 3 = Reversing light/brake light
- 4 = Reversing light
- 5 = Fog tail light (country-specific version: fog tail light on left side only. The bulb on the right side can be used as a spare)

6. Remove bulb from socket.

7. Insert new bulb, without touching the glass.

8. Engage bulb holder in bulb housing, ensuring that it properly engages. Insert three screws with washers and tighten as far as possible.

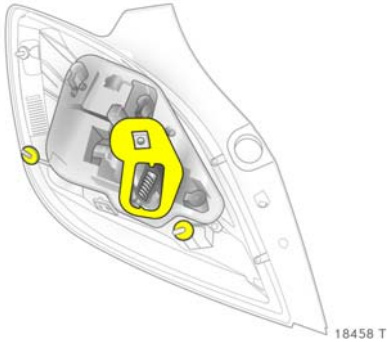

9. Ensure that the seals are applied to the bulb holder and fixing screws.

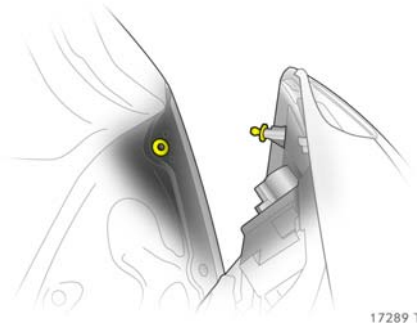

10. Insert the bulb housing in the body, engaging the lug and the ball pin in the recesses. Tighten the fastening nuts using a wheel bolt wrench*. Attach the plug connector. Close and engage the flap.

11. Carry out the following steps to ensure proper function of the tail lights:

- Switch on ignition
- Operate brake
- Switch on parking lights

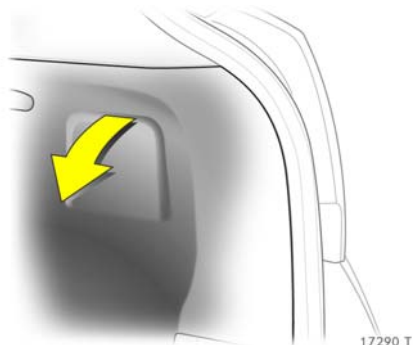

Hatch 3-door

1. To replace bulbs, fold the cover down.

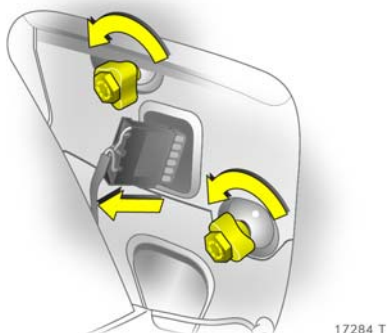

2. Detach plug connector from bulb holder.

3. Hold outside of bulb housing, loosen fastening nuts with wheel bolt wrench * and unscrew by hand. Wheel bolt wrench *, see vehicle tools on page 251.

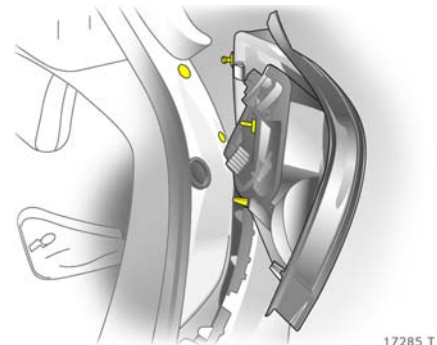

4. Detach bulb housing towards the rear.

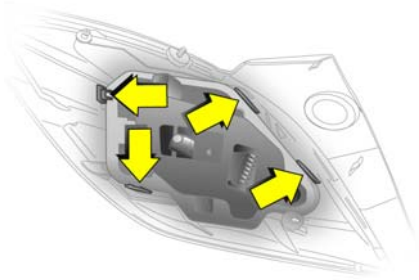

5. Remove the round seal from the fastening bolt. Press the locking tabs on the outside of the bulb holder outward and remove the bulb holder.

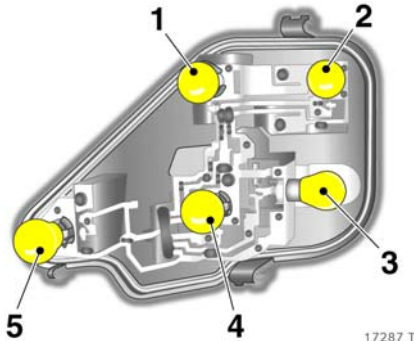

- Bulbs in bulb carrier:
- 1 = Reversing light
 - 2 = Flasher
 - 3 = Reversing light/brake light
 - 4 = Reversing light
 - 5 = Fog tail light (country-specific version: fog tail light on left side only. The bulb on the right side can be used as a spare)

- 6. Remove bulb from socket.
- 7. Insert new bulb, without touching the glass.
- 8. Engage bulb holder in bulb housing, ensuring that it properly engages.

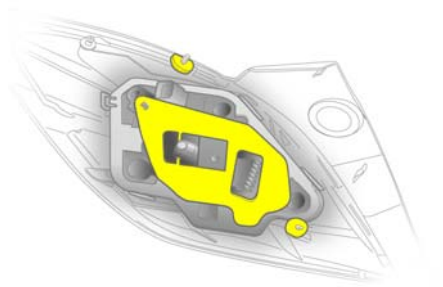

18459 T

9. Ensure that the seals are applied to the bulb holder and fixing screws.

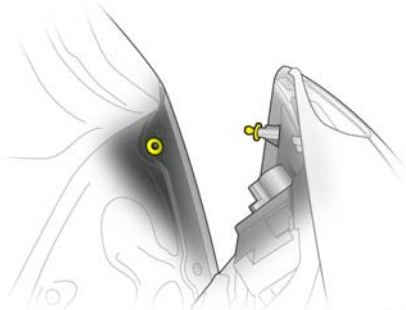

17289 T

10. Insert the bulb housing in the body, engaging the lug and the ball pin in the recesses. Tighten the fastening nuts using a wheel bolt wrench*. Attach the plug connector. Close and engage the flap.

11. Carry out the following steps to ensure proper function of the tail lights:

- Switch on ignition
- Operate brake
- Switch on parking lights

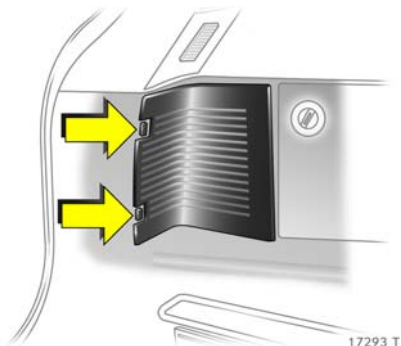
**Estate, Van**

1. Disengage cover by pressing retaining lugs and remove.

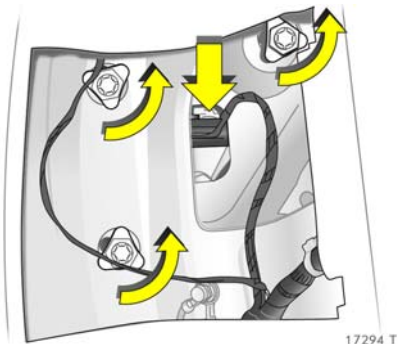

2. Detach plug connector from bulb holder.
3. Hold the outside of the bulb housing, unscrew the three fastening nuts and remove the bulb housing rearwards.

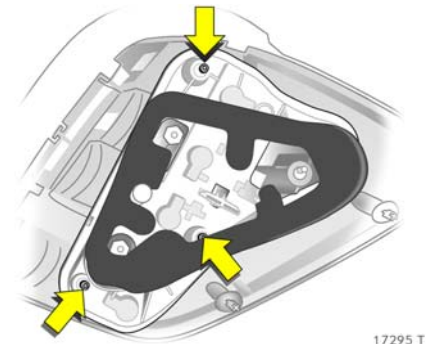

4. Unscrew the three screws with a screwdriver (vehicle tools, see page 251) and remove the bulb holder.

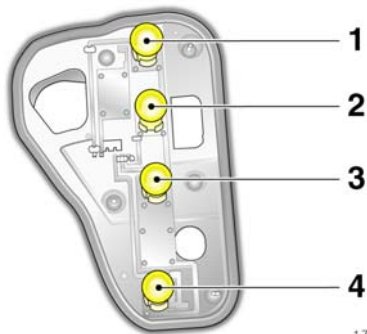

17296 T

Bulbs in bulb carrier:

- 1 = Reversing light/brake light
- 2 = Flasher
- 3 = Reversing light
- 4 = Fog tail light (country-specific version: fog tail light on left side only. The bulb on the right side can be used as a spare)

5. Remove bulb from socket.

6. Insert new bulb without touching the glass. Insert bulb holder in bulb housing and screw in place. Insert bulb housing into body and tighten fastening nuts by hand. Attach plug connector. Close and lock cover.

7. Carry out the following steps to ensure proper function of the tail lights:

- Switch on ignition
- Operate brake
- Switch on parking lights

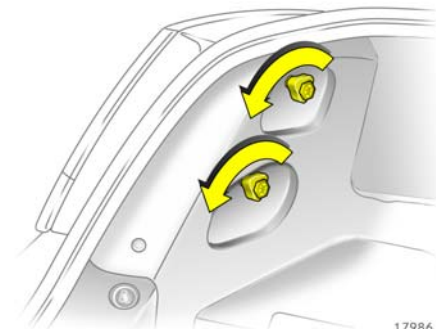

17986 T

Astra TwinTop

1. Unscrew retaining nuts.

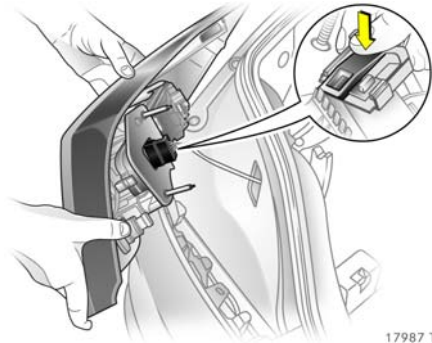

17987 T

2. Remove bulb housing from outside.
Disengage plug by pressing on flap and remove from bulb holder.
3. Detach seal from bulb holder.

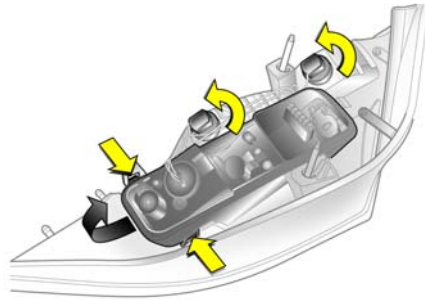

17988 T

4. Disengage sockets by turning and remove. Press locking tabs on the long sides of the bulb holder outwards; lift bulb holder at front end (arrow) and remove.

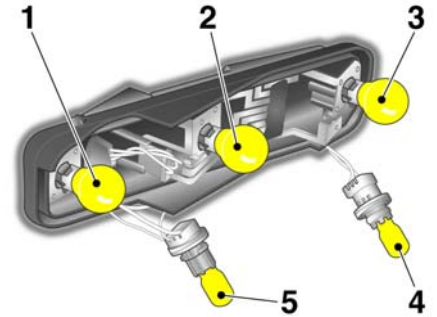

17989 T

Bulbs in bulb carrier:

- 1 = Reversing light/brake light
- 2 = Reversing light
- 3 = Fog tail light (country-specific design: fog tail light on left-side only. The bulb on the right side can be used as a spare)
- 4 = Reversing light
- 5 = Flasher

5. Remove bulb from socket.
6. Insert new bulb, without touching the glass.
7. Insert bulb holder in bulb housing by first inserting the lug at the front of the plug. Fold together bulb holder, ensuring that it engages properly. Insert sockets and engage by turning.

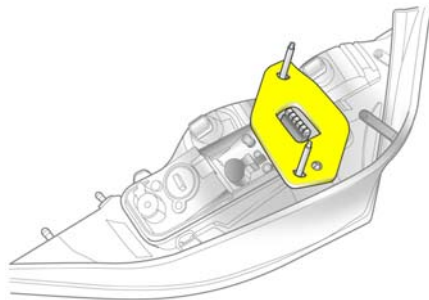

18018 T

8. Fit seal on bulb holder as illustrated. Ensure that the seal is flat in the area of the screws.
9. Engage plug. Insert light housing in body, ensuring proper positioning of the ball pins in the recesses. Tighten the retaining nuts.
10. Carry out the following steps to ensure proper function of the tail lights:
 - Switch on ignition
 - Operate brake
 - Switch on parking lights.

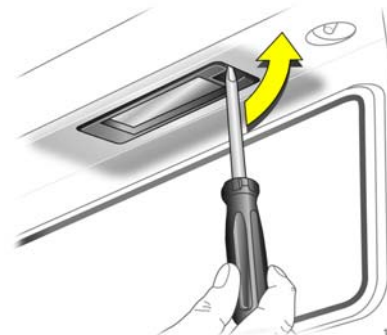

17297 T

Number plate light

1. Insert screwdriver vertically in bulb insert as illustrated in figure. Press to the side and release spring.

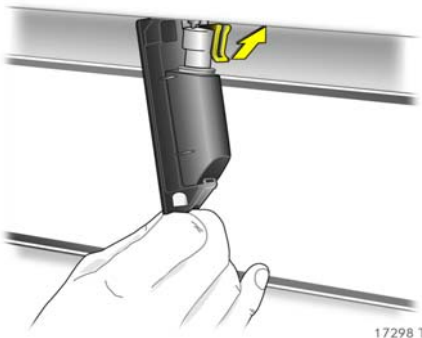

17298 T

- 2. Remove bulb housing downward, taking care not to pull on the cable.
- 3. Lift flap and disconnect plug from bulb socket.

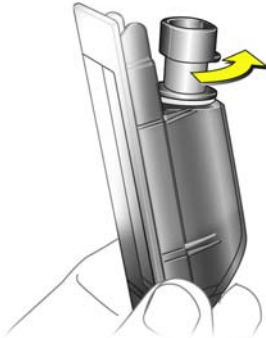

17299 T

- 4. Rotate bulb socket anti-clockwise and disengage.
- 5. Remove bulb from socket.
- 6. Insert new bulb, without touching the glass.
- 7. Insert bulb holder into bulb housing and engage by turning it clockwise.
- 8. Connect plug to bulb socket.
- 9. Insert and engage bulb housing.

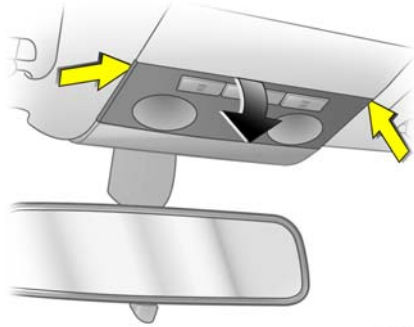

17300 T

Courtesy lights

Front courtesy light, reading lights ✳

To ensure that no power is supplied to the lights, close the doors before removing.

- 1. Disengage lens by hand at location illustrated in figure, press it downward slightly and remove at a downward angle.
- 2. Remove bulb from socket.
- 3. Insert new bulb, without touching the glass.
- 4. Mount lens and engage in position.

**Rear courtesy lights ✳,
rear reading lights ✳**

Have the bulb changed by a workshop.

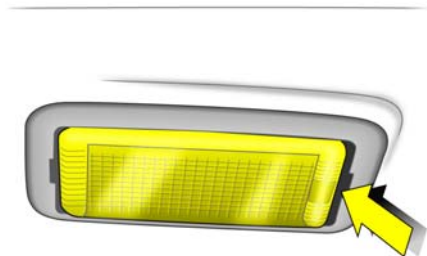

17301 T

**Glove compartment lighting,
luggage compartment lighting,
footwell lighting ✳**

To ensure that no power is supplied to the lights, close the doors or hold the contact switch depressed before removing.

1. Prise the light out with a screwdriver.

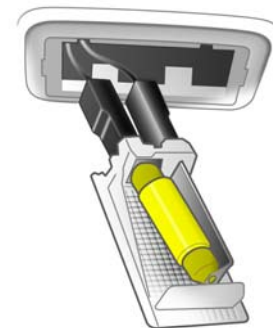

17302 T

2. Press bulb slightly towards spring clip and remove.
3. Insert new bulb, without touching the glass.
4. Insert light in opening and engage in position.

**Instrument illumination,
information display illumination ✳**

Have the bulb changed by a workshop.

Vehicle care

When caring for your vehicle, observe all national environmental regulations, particularly when washing it.

Regular, thorough care helps to improve the appearance of your vehicle and maintain its value over the years. It is also prerequisite for warranty claims for any paint or corrosion damage. The following pages contain tips for vehicle care which, if used properly, will help combat the unavoidable, damaging effects of the environment.

Vehicle care aids*

Vehicle wash:

- Wash brush
- Car Shampoo
- Sponge
- Chamois Leather
- Engine Cleaner
- Glass Cleaner

Vehicle care:

- Paintwork Cleaner
- Car Polish/Colour Restorer
- Car Wax/Sealer
- Metallic Paintwork Wax
- Touch-up Applicator
- Aerosol and Touch-up Paint
- Wheel Preserver
- Insect Remover
- Window Cleaner
- Vauxhall Windscreen Wash Solvent
- Silicone Oil for Rubber Seals
- De-icer

Washing

The paintwork of your vehicle is exposed to environmental influences, e.g. continuous changes in weather conditions, industrial waste gases and dust or thawing salts, so wash and wax your vehicle regularly. When using automatic car washes, select a programme which includes waxing.

Bird droppings, dead insects, resin, pollen and the like should be cleaned off immediately, as they contain aggressive constituents which can cause paint damage.

If using a car wash, comply with the relevant instructions of the car wash manufacturer. The windscreen wiper and rear screen wiper must be switched off, see pages 12, 13, 141. Remove antenna * and roof rack *. Stand on the door sill to reach them more easily.

If you wash your vehicle by hand, make sure that the insides of the wings are also thoroughly rinsed out.

Clean edges and folds on opened doors and flaps as well as the areas they cover.

Thoroughly rinse off and leather-off the vehicle. Rinse leather frequently. Use separate leathers for paint and window surfaces: remnants of wax on the windows will impair vision.

Observe national regulations.

Waxing

Wax your vehicle regularly, in particular after it has been washed using shampoo and at the latest when water no longer forms beads on the paintwork, otherwise the paintwork will dry out.

Also wax edges and folds on opened doors and flaps as well as the areas they cover.

Polishing

Polishing is necessary only if the paint has become dull or if solid deposits have become attached to it.

Paintwork polish with silicone forms a protective film, making waxing unnecessary.

Plastic body parts should not be treated with wax and polish.

Use Metallic Paintwork Wax on vehicles with a metallic-effect paint finish.

Sunroof ❄

Never clean with solvents or abrasive agents, fuels, aggressive media (e.g. paint cleaner, acetone-containing solutions etc.), acidic or highly alkaline media or abrasive pads.

No stickers may be applied to the sunroof.

Wheels

Use a pH-neutral wheel cleaning agent to clean the wheels.

Wheels are painted and can be treated with the same agents as the body. For alloy wheels we recommend use of Alloy Wheel Preserver.

Paintwork damage

Repair minor paintwork damage such as stone chips, scratches etc. immediately using the touch-up pen or spray before rust forms. If rust has already formed, have a workshop eliminate the cause. Also check the surfaces and edges facing the road surface on which rust may have developed unnoticed for some time.

Exterior lights

Headlight and other protective light bezels are made of plastic. If they require additional cleaning after the vehicle has been washed, clean them with Car Shampoo. Do not use any abrasive or caustic agents, do not use an ice scraper, and do not clean them dry.

Plastic and rubber parts

For additional cleaning of plastic and rubber parts use Cleaner. Do not use any other agent, and in particular do not use solvents or petrol.

Do not use high-pressure jet cleaners.

Wheels and tyres

Do not use high-pressure jet cleaners.

Interior and upholstery

Clean the vehicle interior, including the instrument panel fascia, using interior cleaner.

The instrument panel should only be cleaned using a soft damp cloth.

Clean fabric upholstery with a vacuum cleaner and brush. To remove stains, use cleaner that is suitable for both fabrics and vinyl.

Do not use cleaning agents such as acetone, tetrachloride, paint thinner, paint remover, nail varnish remover, washing powder or bleach. Petrol is also unsuitable.

Open Velcro fasteners on clothing could damage seat upholstery. Make sure Velcro fasteners are closed.

Seat belts

Always keep seat belts clean and dry.

Clean only with lukewarm water or Cleaner.

Windows

When cleaning the heated rear window, make sure that the heating element on the inside of the window is not damaged.

Use a soft lint-free cloth or chamois leather in conjunction with Window Cleaner and Insect Remover.

Windscreen Wash Solvent is suitable for de-icing windows.

For mechanical removal of ice, use a commercially available sharp-edged ice scraper. Press the scraper firmly against the glass so that no dirt can get under it and scratch the glass.

Windscreen wiper blades

Wax, such as that used in car washes, can cause streaks to form on the windscreen when the wiper is used.

Smearing wiper blades can be cleaned with a soft cloth and Vauxhall Windscreen Wash Solvent, and replaced if necessary, see page 303.

Locks

The locks are factory-lubricated with a high quality lock cylinder grease. This prevents the locks from freezing. Only use de-icer in urgent cases as this destroys the grease and damages the function of the locks. After using de-icer, have a workshop regrease the locks.

Engine compartment

Areas of the engine compartment that are painted in the same colour as the vehicle must be looked after like any other painted surface.

It is advisable to wash the engine compartment before and after winter and preserve it with wax. Cover alternator and brake fluid reservoir with plastic sheets before washing the engine.

When washing the engine with a steam-jet cleaner, do not direct the steam jet at components of the anti-lock brake system, the air conditioning system, the climate control system or the belt drive and its components.

Engine washing also removes subsequently applied protective wax. Therefore after washing, have a workshop protect the engine, parts of the braking system in the engine bay, axle elements with steering, body elements and cavities, thoroughly with protective wax.

An engine wash can be performed in the spring in order to remove dirt that has adhered to the engine compartment, which may also have a high salt content. Check protective wax layer and make good if necessary.

Do not use high-pressure jet cleaners.

Underbody

PVC underbody protection is applied in the factory in the areas that are affected by wheel spray, including the longitudinal sides of the underbody. This provides long-term protection and does not require special maintenance.

The areas of the vehicle underbody that are not covered with PVC have a permanent protective wax coating in critical areas.

On vehicles which are washed frequently in automatic car washes with underbody washing facility, the protective wax coating may be impaired by dirt-dissolving additives.

Check the underbody after washing and have it waxed if necessary. Before the start of the cold weather season, check the PVC coating and protective wax coating. Have them restored to perfect condition if necessary.

Caution – commercially available bitumen/ rubber materials can damage the PVC coating. We recommend that you have underbody work carried out by a workshop, who knows the prescribed materials and has experience in the use thereof.

The underbody should be washed following the end of the cold weather season to remove any dirt adhering to the underbody since this may also contain salt. Check protective wax coating and, if necessary, have it restored to perfect condition.

Astra TwinTop

Treat all seals, e. g. on the roof and windscreen frame, with silicone oil from time to time. Good contact between the fine rubber lips and the sealing surfaces prevents leaks and reduces clamping forces.

The roof can be held in an intermediate position for about 9 minutes by releasing the operating switch in order to clean roof spaces.

Intermediate roof position for cleaning – see page 58.

Do not use high-pressure jet cleaners.

Service, maintenance

Service, maintenance	294
Inspection system	296
Genuine Vauxhall Parts and Accessories	297
A note on safety	297
Checking and topping up fluids	298
Engine oil	298
Diesel fuel filter	300
Coolant	300
Brake fluid	302
Windscreen wiper	303
Windscreen and headlight wash systems *	305
Battery	306
Protecting electronic components	306
Vehicle decommissioning	307
Vehicle recommissioning	307

In our experience, the most common cause of all complaints is the result of misunderstanding or lack of communication between the customer and the Vauxhall Authorised Repairer.

We sincerely hope you will never have cause to complain about your vehicle. However, if things do go wrong, the best course of action for you to take is to contact your Vauxhall Authorised Repairer's Service Reception Staff and explain the difficulty you are having. We are confident they will do their utmost to resolve the problem to your complete satisfaction.

Sometimes, however, despite the best of intentions of all concerned, misunderstandings can occur. If your problem has not been resolved to your satisfaction, please make an appointment to discuss the matter with the Manager of the department concerned.

The majority of areas of concern can be quickly resolved in this way.

Should you wish to pursue the matter further, the Principal of the Vauxhall Authorised Repairer should be made aware of your concern. It is advisable in cases such as this to write to him to confirm your problem and the solutions that have been offered.

You can be assured the Authorised Repairer's Principal will only be too anxious to fully investigate your problems and correct any errors made. After all, he has a

large investment in his business and is proud of his reputation and professionalism and fully realises that satisfied customers are his key to success.

In the unlikely event that you are still not happy with the answer your Vauxhall Authorised Repairer has given, or the action he proposes to correct the problem, you may contact the Customer Care Department¹⁾ where a team of Customer Care Consultants will spare no effort to ensure your complete satisfaction.

Vauxhall Motors Ltd.

Customer Care,
Griffin House,
Osborne Road
LUTON,
Beds., LU1 3YT
Telephone: 0845 090 2044

They will review all the facts involved. Then if it is felt some further action can be taken, the Vauxhall Authorised Repairer will be advised accordingly. In any case, your contact will be acknowledged confirming Vauxhall Motors' position in the matter.

If you are not satisfied with the outcome, you can if you wish, seek advice from an independent third party such as:

Automobile Association (A.A.)
Fanum House, Basing View,
BASINGSTOKE,
Hants., RG21 4EA

¹⁾ Calls may be monitored and recorded for training purposes.

Royal Automobile Club (R.A.C.),
R.A.C. Motoring Services Ltd..
89-91 Pall Mall,
LONDON, SW1Y 5HS

The Customer Relations Department,
Society of Motor Manufacturers and Traders Ltd. (S.M.M.T.),
Forbes House, Halkin Street,
LONDON, SW1X 7DS

Customer Complaints Service,
Scottish Motor Trade Association,
(S.M.T.A.),
3 Palmerston Place,
EDINBURGH, EH12 5AQ

The National Conciliation Service,
Retail Motor Industry Federation,
9 North Street,
RUBGY, CV21 2AB

If you have a problem whilst abroad:
The Service Departments of ADAM OPEL GmbH and General Motors branches everywhere will provide information and assistance:

In **Luxembourg** please contact the General Motors Service Department in Antwerp – Belgium
Telephone: 00 32-34 50 63 29

General Motors Austria GmbH
Groß-Enzersdorfer Str. 59
1220 Vienna – Austria
Tel. 00 43-1-2 88 77 444 or
00 43-1-2 88 77 0

General Motors Belgium N.V.
Noordelaan 401 - Haven 500
2030 Antwerp – Belgium
Tel. 00 32-34 50 63 29

General Motors Southeast Europe
org. složka
Olbrachtova 9
140 00 Prague – Czech Republic
Tel. 00 420-2 39 004 321

General Motors Danmark
Jaegersborg Alle 4
2920 Charlottenlund – Denmark
Tel. 00 45-39 97 85 00

Vauxhall Motors Ltd.
Customer Care
Griffin House, Osborne Road
Luton, Bedfordshire, LU1 3YT – England
Tel. 00 44-845 090 2044

General Motors Finland Oy
Pajuniityntie 5
00320 Helsinki – Finland
Tel. 00 358-9 817 101 47

General Motors France
1 – 9, avenue du Marais
Angle Quai de Bezons
95101 Argenteuil Cedex – France
Tel. 00 33-1-34 26 30 51

ADAM OPEL GmbH
Bahnhofsplatz 1
65423 Rüsselsheim – Germany
Tel. 00 49-61 42-77 50 00 or
00 49-61 42-7 70

General Motors Hellas S.A.
56 Kifisias Avenue & Delfon str.
Amarousion
151 25 Athens – Greece
Tel. 00 30-1-6 80 65 01

General Motors Southeast Europe Ltd.
Szabadsag utca 117
2040 Budaörs – Hungary
Tel. 00 36-23 446 100

General Motors India
Sixth Floor, Tower A
Global Business Park
Mehrauli – Gurgaon Road
Gurgaon 122 022, Haryana – India
Tel. 00 91-124 280 3333

General Motors Ireland Ltd.
Opel House, Unit 60, Heather Road
Sandyford, Dublin 18 – Ireland
Tel. 00 353 1-216 10 00

General Motors Italia Srl
Piazzale dell'Industria 40
00144 Rome – Italy
Tel. 00 39-06-5 46 51

General Motors Nederland B.V.
Lage Mosten 49 – 63
4822 NK Breda – Netherlands
Tel. 00 31-76-5 44 83 00

General Motors Norge AS
Kjeller-Vest 6
2027 Kjeller – Norway
Tel. 00 47-23 50 01 04

General Motors Poland Sp. z o. o.
Wolaska 5
06-675 Warsaw – Poland
Telephone 00 48-22-606 17 00

General Motors Portugal
Quinta da Fonte
Edifício Fernão Magalhães, Piso 2
2780-190 Paço d'Arcos – Portugal
Tel. 00 351- 21 440 75 00

General Motors Southeast Europe
org. zložka
Apollo Business Centre
Mlynské Nivy 45
821 09 Bratislava - Slovakia
Tel. 00 421-2 58 275 543

General Motors España S.L.
Paseo de la Castellana, 91
28046 Madrid – Spain
Tel. 00 34-902 25 00 25

General Motors Norden AB
Årstaängvägen 17
100 73 Stockholm – Sweden
Tel. 00 46-20 333 000

General Motors Suisse S.A.
Stelzenstraße 4
8152 Glattbrugg – Switzerland
Tel. 00 41-44 828 28 80

General Motors Türkiye Ltd. Sti.
Kemalpaşa yolu üzeri
35861 Torbalı / Izmir – Turkey
Tel. 00 90-2 32-8 53-14 53

In **Albania, Bosnia-Herzegovina, Bulgaria, Croatia, Estonia, Latvia, Lithuania, Macedonia, Romania, Serbia-Montenegro and Slovenia** please contact the General Motors Service Department in Budaörs – Hungary
Tel. 00 36-23 446 100



Inspection system

In order to guarantee economical and safe vehicle operation and to maintain the value of your vehicle, it is of vital importance that all maintenance work is carried out at the proper intervals as specified.

In vehicles with a fixed engine oil change and service interval, **InSP** appears in the odometer display when the ignition is switched on when the service work is due: have the relevant service work carried out by a workshop within one week or 300 miles (500 km).

The service interval display takes account of off-the-road periods during which the battery is disconnected.

For vehicles with flexible engine oil change and service intervals, the length of these intervals is based on several parameters stemming from usage. For this reason, various engine-specific data is continually gathered and is used to calculate the remaining distance until the next service.

This remaining distance can be displayed with the ignition off: briefly press the trip odometer reset button, the mileage reading shows. Press the button again for around 2 seconds, **InSP** and the remaining distance is shown.

If the remaining distance is less than 1000 miles (1500 km), **InSP** is displayed with a remaining distance of 600 miles (1000 km) when the ignition is switched on and off. **InSP** is displayed for several seconds if the remaining distance is less than 600 miles (1000 km). Have the service work that is due carried out within one week or 300 miles (500 km). Have this work carried out by a Vauxhall Authorised repairer in order to avoid invalidation of warranty claims.

Further information on maintenance and the inspection system can be found in the service booklet, which is in the glove compartment.

Have service work – and repairs to the bodywork and components – performed properly by a workshop. We recommend your Vauxhall Authorised repairer, who has excellent knowledge of Vauxhall vehicles and is in possession of the necessary tools and current service instructions from Vauxhall. To exclude the possibility of loss of warranty, use of a Vauxhall Authorised repairer is recommended in particular during the warranty period. For further information see the Service Booklet.

Separate anti-corrosion service

Have the work performed by a workshop at the intervals specified in the Service Booklet.

Genuine Vauxhall Parts and Accessories

We recommend that you use "Genuine Vauxhall Parts and Accessories" and conversion parts expressly approved for your vehicle type. These parts have undergone special tests to establish their reliability, safety and specific suitability for Vauxhall vehicles. Despite continuous market monitoring, we cannot assess or guarantee these attributes for other products, even if they have been granted approval by the relevant authorities or in some other form.

"Genuine Vauxhall Parts and Accessories" and conversion parts approved by Vauxhall can be obtained from your Vauxhall Authorised repairer, who can provide comprehensive advice about permissible technical changes and ensure that the part is installed correctly.

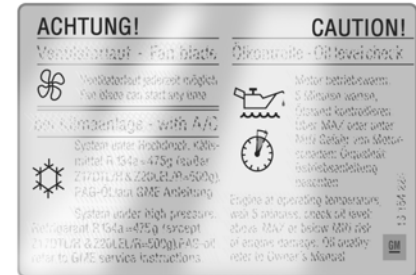

17304 T

A note on safety

To avoid injury from moving parts and cables conducting ignition voltage, only carry out engine compartment checks (e.g. checking brake fluid or engine oil level) when the ignition is switched off.

Warning

The cooling fan is controlled by a thermoswitch and can therefore start unexpectedly even if the ignition is switched off. Risk of injury.

Electronic ignition systems generate very high voltages. Do not touch the ignition system; high voltage can be fatal.

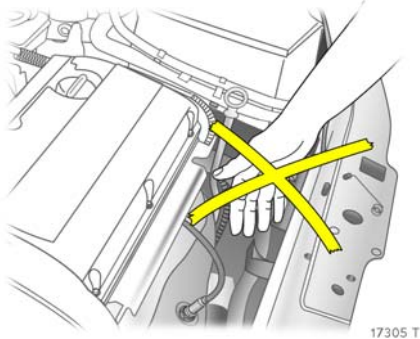

17305 T

Never carry out any repairs or adjustment and maintenance work on the vehicle yourself. This especially applies to the engine, chassis and safety parts. You may unwittingly infringe the provisions of the law and, by not performing the work properly, endanger yourself and other road users.

Checking and topping up fluids

The caps that are used when topping up engine oil, coolant and wash fluid as well as the oil dipstick may be coloured yellow to aid identification.

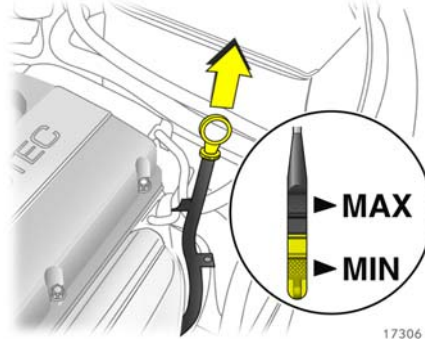

17306 T

Engine oil

Information on engine oils is found in the Service Booklet.

Engine oil level and consumption

Every engine consumes engine oil for technical reasons. The engine oil consumption cannot be assessed until a fairly long distance has been driven, and may be above the specified value when the vehicle is first being driven (run-in period). Frequent driving at high revs increases engine oil consumption.

Warning

Do not allow the engine oil level to drop below the minimum level!

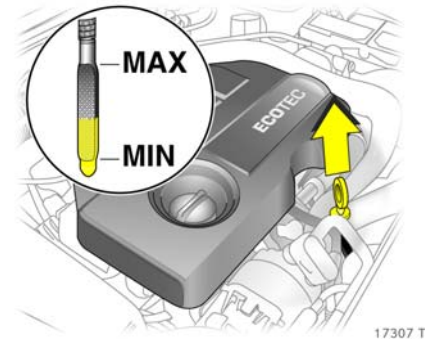

17307 T

In vehicles with engine oil level monitoring  the engine oil level is monitored automatically¹⁾, see page 116. It is advisable to check the engine oil level before setting off on long journeys.

¹⁾ Not on Z 14 XEP or Z 20 LEH engine.
Sales designation – see pages 310, 311.

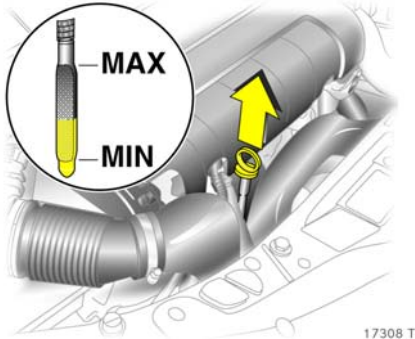

Checking the engine oil level, topping up engine oil

The pictures show the inspection of a petrol and two diesel engines.

The oil level must be checked with the vehicle on a level surface and with the engine (which must be at operating temperature) switched off. Wait at least 5 minutes before checking the level to allow the normal engine oil accumulation in the engine to drain into the oil pan.

Warning

It is the owner's responsibility to maintain the correct level of an appropriate quality oil in the engine.

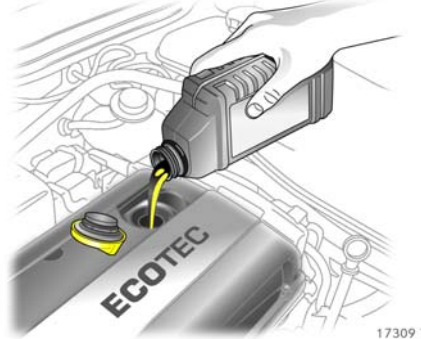

To check the engine oil level, wipe the oil from dipstick and insert dipstick into handle as far as it will go. Top engine oil up if the level has dropped into the range of the top-up mark **MIN**.

The engine oil level must not exceed the upper mark **MAX** on the dipstick. Excess engine oil must be drained off or extracted. If the engine oil level is above the **MAX** mark there is a risk of damage to the engine or the catalytic converter.

Capacity between **MIN** and **MAX** marks, see pages 346, 347.

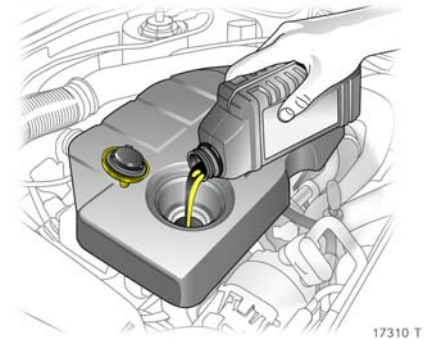

Top up with the same brand of engine oil that was used during the previous oil change, following the instructions in the service booklet.

To close, position the cap and screw it into place.

Capacities, see pages 346, 347.

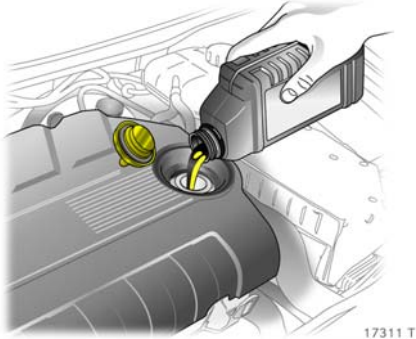

Engine oil change, oil filter change

Have a workshop change the oil at the specified service intervals.



We recommend that you use genuine engine oil filters.

Warning

Empty engine oil cans do not belong in the domestic rubbish. Please comply with the legal, environmental and health regulations as regards the disposal of used oil and engine oil filters.

Diesel fuel filter

On each engine oil change, have the fuel filter checked for any water residue by a workshop.

Illumination of  indicates water in the fuel filter .

Have fuel filter checked at shorter intervals if the vehicle is subjected to extreme operating conditions such as high humidity (primarily in coastal areas), extremely high or low outside temperatures and substantially varying daytime and night-time temperatures.

Coolant

The glycol-based coolant provides excellent corrosion protection for the heating and cooling systems as well as antifreeze protection down to around -28 °C. It remains in the cooling system throughout the year and need not be changed.

Use of certain antifreezes can lead to engine damage. We therefore recommend that you only use antifreezes that have been approved.

Warning

Antifreeze is a danger to health; it must therefore be kept in the original container and out of the reach of children.

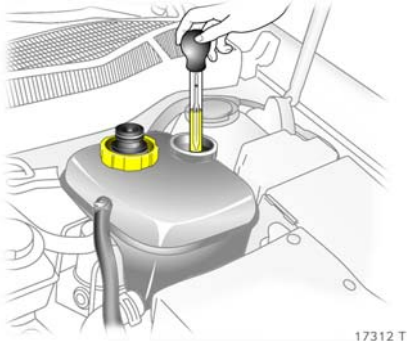

17312 T

Antifreeze and corrosion protection

Before the start of winter, have a workshop check the antifreeze protection. The antifreeze level must guarantee protection to approx. -28 °C. Insufficient antifreeze will reduce the frost protection level and the corrosion protection. If necessary add antifreeze.

If coolant loss is topped up with water, have concentration checked and add antifreeze if necessary.

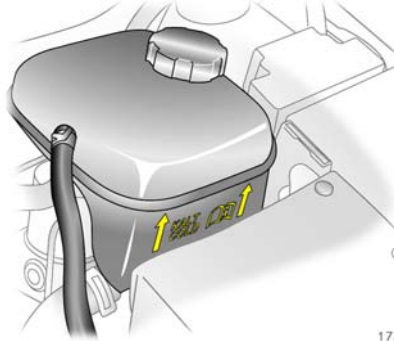

17313 T

Coolant level

Hardly any losses occur since the cooling system is sealed and it is thus rarely necessary to top up the coolant.

The coolant should be a little above the **KALT/COLD** mark in the expansion tank with a cold cooling system. The coolant level can also be read off from the outside of the expansion tank.

Warning

Allow engine to cool down before removing coolant filler cap. Remove filler cap carefully so that pressure can escape slowly, otherwise there is a risk of scalding.

When the engine is at operating temperature, coolant level rises. It falls again when the system cools. If it falls below the **KALT/COLD** mark when the system is cold, top up to just above the mark.

Top up antifreeze. If no antifreeze is available, top up with clean tap water. If tap water is unavailable, distilled water can be used.

After topping up with water or distilled water, check the antifreeze concentration and add antifreeze if necessary. Have a workshop eliminate the cause of the coolant loss.

Too low a coolant level can cause engine damage.

To close, position the cap and screw it into place.

Coolant temperature

Control indicator  illuminates when coolant temperature is too high. Check coolant level immediately:

- Coolant level too low:
Add coolant, see notes under "Antifreeze and corrosion protection", and "Coolant level". Have a workshop eliminate the cause of the coolant loss.
- Coolant level OK:
Have the cause of the raised coolant temperature eliminated. Contact a workshop.

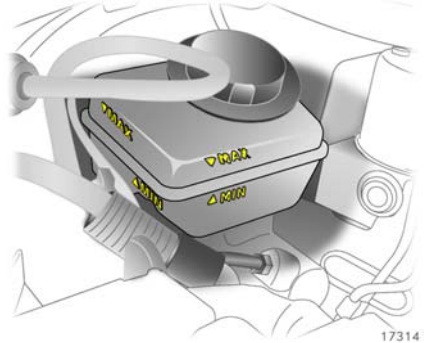

Brake fluid

Brake fluid level

Warning

Brake fluid is toxic and caustic. Keep away from eyes, skin, textiles and painted surfaces. Direct contact can cause injuries and damage.

The fluid level in the reservoir must be neither higher than the **MAX** mark nor lower than the **MIN** mark.

The use of certain brake fluids can cause damage or loss of braking power. We therefore recommend the use of high-performance brake fluid that has been approved.

When topping up, ensure maximum cleanliness as contamination of the brake fluid can lead to function problems in the braking system.

After correcting the brake fluid level, have a workshop eliminate the cause of the brake fluid loss.

Brake fluid change

Brake fluid is hygroscopic, i.e. it absorbs water. If the brakes become hot, such as when driving on long downhill stretches, vapour bubbles can occur in the water, which can have an extremely adverse effect on braking power (depending on the proportion of water).

The fluid change intervals specified in the Service Booklet must therefore be observed.

 **Warning**

Have the brake fluid change performed by a workshop. Please comply with the legal, environmental and health regulations as regards the disposal of brake fluid.

Windscreen wiper

Clear vision is essential for safe driving.

Perform regular checks on the windscreen wiper and headlight wash system * to ensure they are operating correctly. We recommend wiper blade replacement at least once a year.

If the windscreen is dirty, operate the windscreen wash system before switching on the windscreen wiper or setting the wiper to automatic operation with the rain sensor *. This will avoid wiper blade wear.

Do not switch on the windscreen wiper or set them to automatic operation with the rain sensor * if the windscreen is iced up as this could damage the wiper blades or the wiper system.

We recommend releasing frozen wiper blades with defroster spray.

Smearing wiper blades can be cleaned with a soft cloth and Vauxhall Windscreen Wash Solvent.

Wiper blades whose lips have become hardened, cracked or covered with silicone must be replaced. This may be necessary as a result of the effects of ice, thawing salt or heat, or the incorrect use of cleaning agents.

Switch off the windscreen wiper or automatic wiper with rain sensor * in car wash, see pages 12, 13, 141, 289.

Windscreen wiper care, see page 291.

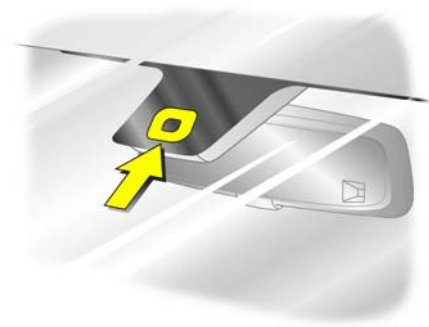

17315 T

To ensure proper operation of the rain sensor * the sensor area must be free from dust, dirt and ice, which is why the windshield wash system must be operated at regular intervals and the sensor area de-iced. Vehicles with rain sensor * can be identified by the sensor area near the top of the windshield.

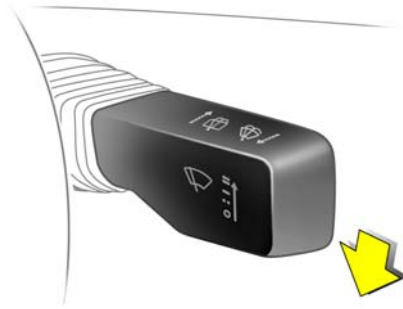

17316 T

Service setting for front windscreen wiper (e.g. for changing or cleaning the front wiper blades).

Within 4 seconds from turning off the ignition, with the key still in the lock * or for the Open&Start System * after switching off the ignition and before opening the driver's door, move the wiper stalk down. Release wiper stalk as soon as the wiper is vertical.



17317 T

Wiper blades on the windscreen

Activate service setting – see previous column. Raise wiper arm, tilt wiper blade at 90° to the wiper arm and remove to the side.

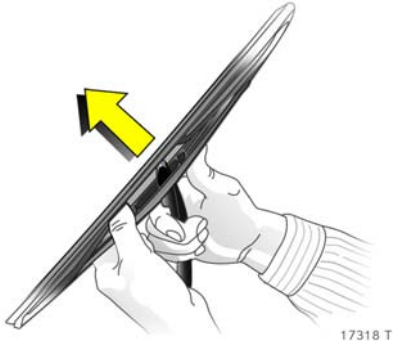

Wiper blade on the rear window ✱
Lift wiper arm. Disengage wiper blade as shown in Fig. 17318 T, and remove.

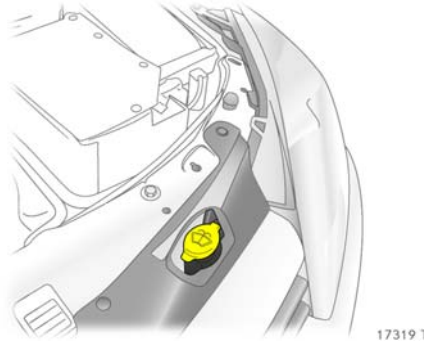

Windscreen and headlight wash systems ✱

The fluid reservoir filler neck for the windscreen wash system and headlight wash system ✱ is located at the front, next to the left headlight.

Capacities, see pages 346, 347.

Fill only with clean water to prevent the nozzles from clogging. To improve cleaning efficiency, we recommend that you add a little Vauxhall Windscreen Wash Solvent.

The windscreen wash system and headlight wash system will not freeze in winter:

Frost protection down to	Mixing ratio of Vauxhall Windscreen Wash Solvent to water
-5 °C	1 : 3
-10 °C	1 : 2
-20 °C	1 : 1
-30 °C	2 : 1

When closing the reservoir, press the lid firmly over the beaded edge all the way round.

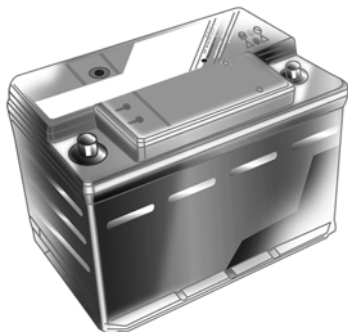

17320 T

Battery

The battery is maintenance-free.

Warning

Have the battery change performed by a workshop. Please comply with the legal, environmental and health regulations as regards the disposal of old batteries.

Fitting of electrical or electronic accessories at a later date can discharge or add extra load to the battery. Take advice on the technical possibilities, e.g. use of a more powerful battery.

Parking the vehicle for more than 4 weeks can lead to battery discharging. This may reduce the service life of the battery. Disconnect battery from on-board power supply by disconnecting the negative terminal.

The Vauxhall alarm system *siren must be deactivated as follows: switch the ignition on then off, disconnect the vehicle's battery within 15 seconds.

Ensure that ignition is switched off before connecting battery. Then perform the following actions:

- Setting date and time in the information display, see pages 124, 127, 132.
- If necessary activate the window and sunroof electronics *, see pages 51, 54.

In order to prevent the battery from discharging, some consumers such as the courtesy light automatically switch off after approx. 20 minutes.

Disconnecting/connecting the battery from/to the electrical system

Before charging, isolate the battery from the on-board network. First remove the negative and then the positive terminal.

Do not reverse the polarity of the battery, i.e. the terminals for the positive and negative leads. When connecting, start with the positive lead and then connect the negative lead.

Protecting electronic components

In order to prevent faults in electronic components in the electrical system, never connect or disconnect battery with engine running or ignition switched on. Never start engine with battery disconnected, e.g. when starting using jump leads.

To avoid damaging the vehicle, do not make any modifications to the electrical system, e.g. connecting additional consumers or tampering with electronic control units (chip tuning).

Warning

Electronic ignition systems generate very high voltages. Do not touch the ignition system; high voltage can be fatal.

Vehicle decommissioning

Observe national regulations.

If the vehicle is to be parked for several months, to avoid damage have the following work performed by a workshop.

- Wash and preserve the vehicle, see page 289.
- Check corrosion protection in engine compartment and on underbody and repair if necessary.
- Clean and wax the rubber seals of the bonnet, doors and roof. Intermediate position of the Astra TwinTop roof for cleaning – see page 58.
- Change engine oil, see page 300.
- Check antifreeze and corrosion protection, see page 301.
- Check the coolant level, top up with antifreeze if necessary, see page 301.
- Empty windscreen wash system and headlight wash system.
- Increase tyre pressure to value specified for full load, see page 337.

Vehicle storage

- Park vehicle in dry, well ventilated place. With manual transmission ✱, engage 1st or reverse gear. With automatic transmission ✱, move selector lever to P. Use chocks or the like to prevent the vehicle from rolling.
- Do not apply handbrake.
- Disconnect battery by disengaging negative terminal from vehicle electrical system, see page 306.

Vehicle recommissioning

Observe national regulations.

Perform the following work before recommissioning the vehicle:

- Connect battery, see page 306.
- Check tyre pressure and correct if necessary, see page 337.
- Fill up windscreen wash system, see page 305.
- Check engine oil level, see page 298.
- Check the coolant level; top up with antifreeze if necessary, see page 301.
- Fit the number plates if necessary.

Technical data

Vehicle documents, identification plate.....	308
Vehicle identification data.....	309
Coolant, brake fluid, oils.....	309
Engine data.....	310
Performance.....	312
Fuel consumption, CO ₂ emissions.....	316
Weights, payload and roof load.....	325
Tyres.....	337
Electrical system.....	345
Capacities.....	346
Dimensions.....	347
Installation dimensions of trailer towing equipment.....	348

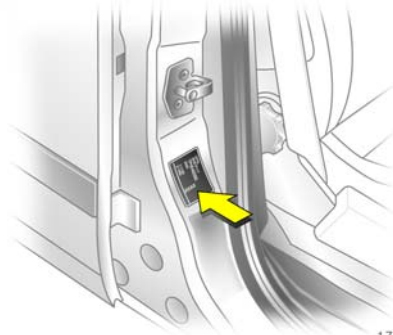

17321 T

Vehicle documents, identification plate

The technical data is determined in accordance with European Community standards. We reserve the right to make modifications. Specifications in the vehicle documents always have priority over those given in this manual.

The identification plate is affixed to the front right door frame.



17322 T

Information on identification plate:

- 1 Manufacturer
- 2 Type approval number
- 3 Vehicle identification number
- 4 Gross vehicle weight rating
- 5 Permissible gross train weight
- 6 Maximum permissible front axle load
- 7 Maximum permissible rear axle load
- 8 Vehicle-specific or country-specific data



Vehicle identification data

The vehicle identification number is stamped on the identification plate in the vehicle floor, on the right-hand side under a cover between the driver's door and seat.

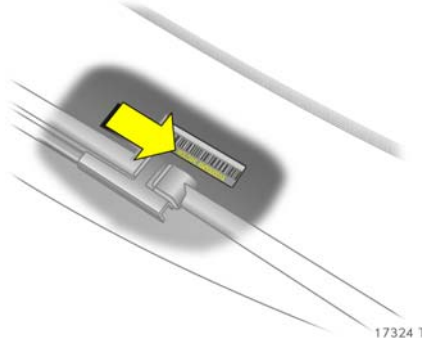

The vehicle identification number may be embossed on the instrument panel.
 Engine code and engine number: stamped on left-hand side of engine on crankcase.

Coolant, brake fluid, oils

Only use approved fluids.

Use of unsuitable fluids can cause serious damage to the vehicle.

Engine oils

Information on engine oils is found in the Service Booklet.

310 Technical data

Engine data

Sales designation Engine identifier code	1.4 Z 14 XEP	1.6 Z 16 XER	1.6 Z 16 LET	1.8 Z 18 XER	VXR Z 20 LEH
Number of cylinders	4	4	4	4	4
Piston displacement (cm ³)	1364	1598	1598	1796	1998
Brake horse power (kW) at rpm	66 5600	85 6000	132 5500	103 6300	177 5600
Torque (Nm) at rpm	125 4000	155 4000	230 1980 to 5500	175 ¹⁾ 3800	320 4000 to 5000
Type of fuel	Petrol	Petrol	Petrol	Petrol	Petrol
Octane requirement (RON) ²⁾ unleaded or unleaded or unleaded	95 (S)^{3) 4)} 98 (SP) ³⁾ 91 (N) ³⁾	95 (S)³⁾ 98 (SP) ³⁾ 91 (N) ³⁾⁴⁾	95 (S) ³⁾ 98 (SP)³⁾ - ⁵⁾	95 (S)³⁾ 98 (SP) ³⁾ 91 (N) ³⁾⁶⁾	95 (S)³⁾⁷⁾ 98 (SP) ³⁾ 91 (N) ³⁾⁶⁾
Max. permissible engine speed, continuous operation (rpm) approx.	6200	6500	6500	6800	6400
Oil consumption (l/1000 km)	0.6	0.6	0.6	0.6	0.6

1) For versions with automatic transmission 170 Nm.

2) Standard high-quality fuels, e.g. unleaded DIN EN 228; value printed in bold: recommended fuel.

3) Knock control system automatically adjusts ignition timing according to type of fuel used (octane number).

4) Use of 91 RON fuel reduces power and torque.

5) The use of fuel with an octane number of 91 RON is not permitted.

6) If no unleaded Premium fuel is available, 91 RON can be used to avoid high engine load or full load as well as for driving in mountainous terrain with a caravan/ trailer load or high payload.

7) Use of 95 RON fuel reduces power and torque. Slight increase in fuel consumption.

Engine data

Sales designation Engine identifier code	1.7 CDTI Z 17 DTH	1.9 CDTI Z 19 DT	1.9 CDTI Z 19 DTH
Number of cylinders	4	4	4
Piston displacement (cm ³)	1686	1910	1910
Brake horse power (kW) at rpm	74 4400	88 3500	110 4000
Torque (Nm) at rpm	240 2300	280 2000 to 2750	320 2000 to 2750
Type of fuel	Diesel	Diesel	Diesel
Cetane requirement (CN) ¹⁾	49 (D) ²⁾	49 (D) ²⁾	49 (D) ²⁾
Max. permissible engine speed, continuous operation (rpm) approx.	5100 to 5200	5020 to 5180	5020 to 5180
Oil consumption (l/1000 km)	0.6	0.6	0.6

¹⁾ Standard high-quality fuels, e.g. Diesel DIN EN 590; value printed in bold: recommended fuel.

²⁾ A lower value is possible with winter fuels.

Performance

(approx. mph / km/h), **5-door Hatchback**

Engine ¹⁾	Z 14 XEP	Z 16 XER	Z 16 LET	Z 18 XER
Maximum speed ²⁾				
Manual transmission	111/178	191	137/221	129/208
Easytronic	110/176	192	–	–
Automatic transmission	–	–	–	117/188

Engine ¹⁾	Z 20 LEH	Z 17 DTH	Z 19 DT	Z 19 DTH
Maximum speed ²⁾				
Manual transmission	143/230	112/180	121/194	129/208 ³⁾
Easytronic	–	–	–	–
Automatic transmission	–	–	117/188	–

1) Sales designation, see pages 310 and 311.

2) The maximum speed indicated is achievable at kerbweight (without driver) plus 200 kg payload. Optional equipment could reduce the specified maximum speed of the vehicle.

3) The maximum speed is limited electronically.

Performance

(approx. mph / km/h), **3-door Hatchback**

Engine ¹⁾	Z 14 XEP	Z 16 XER	Z 16 LET	Z 18 XER
Maximum speed ²⁾				
Manual transmission	112/180	120/193	139/223	130/210
Easytronic	111/178	121/194	–	–
Automatic transmission	–	–	–	118/190

Engine ²⁾	Z 20 LEH	Z 17 DTH	Z 19 DT	Z 19 DTH
Maximum speed ²⁾				
Manual transmission	152/244	113/182	122/196	130/210 ³⁾
Easytronic	–	–	–	–
Automatic transmission	–	–	118/190	–

1) Sales designation, see pages 310 and 311.

2) The maximum speed indicated is achievable at kerbweight (without driver) plus 200 kg payload. Optional equipment could reduce the specified maximum speed of the vehicle.

3) The maximum speed is limited electronically.

Performance

(approx. mph / km/h), **Estate**

Engine¹⁾	Z 14 XEP	Z 16 XER	Z 16 LET	Z 18 XER
Maximum speed ²⁾				
Manual transmission	111/178	119/191	137/221	129/207
Easytronic	–	119/192	–	–
Automatic transmission	–	–	–	117/188

Engine¹⁾	Z 17 DTH	Z 19 DT	Z 19 DTH
Maximum speed ²⁾			
Manual transmission	112/180	120/193	129/207 ³⁾
Easytronic	–	–	–
Automatic transmission	–	116/187	–

1) Sales designation, see pages 310 and 311.

2) The maximum speed indicated is achievable at kerbweight (without driver) plus 200 kg payload. Optional equipment could reduce the specified maximum speed of the vehicle.

3) The maximum speed is limited electronically.

Performance

(approx. mph / km/h), **Van**

Engine ¹⁾	Z 14 XEP	Z 16 XER	Z 17 DTH	Z 19 DT	Z 19 DTH
Maximum speed ²⁾					
Manual transmission	111/178	119/191	112/180	120/193	129/207
Easytronic	–	119/192	–	–	–
Automatic transmission	–	–	–	116/187	–

Performance

(approx. mph / km/h), **TwinTop**

Engine ¹⁾	Z 16 XER	Z 16 LET	Z 18 XER	Z 19 DTH
Maximum speed ²⁾				
Manual transmission	119/192	142/228	129/209	132/213
Easytronic	120/193	–	–	–
Automatic transmission	–	–	117/189	–

¹⁾ Sales designation, see pages 310 and 311.

²⁾ The maximum speed indicated is achievable at kerbweight (without driver) plus 200 kg payload. Optional equipment could reduce the specified maximum speed of the vehicle.

Fuel consumption, CO₂ emissions

Directive 80/1268/EEC (last modified by 2004/3/EC) has applied for the measurement of fuel consumption since 1996.

The directive is oriented to actual driving practices: Urban driving is rated at approx. $\frac{1}{3}$ and off-road driving with approx. $\frac{2}{3}$ (urban and extra-urban consumption). Cold starts and acceleration phases are also taken into consideration.

The specification of CO₂ emission is also a constituent of the directive.

The figures given must not be taken as a guarantee for the actual fuel consumption of a particular vehicle.

All values are based on the EU base model with standard equipment.

The calculation of fuel consumption as specified by directive 2004/3/EC takes account of the vehicle's kerbweight, ascertained in accordance with these regulations. Optional extras may result in slightly higher fuel consumption and CO₂ emission levels than those quoted.

To convert l/100 km into mpg, divide 282 by number of litres/100 km.

Saving fuel, protecting the environment, see page 200.

Fuel consumption (approx. l/100 km), **CO₂ emissions** (approx. g/km), **Hatch 5-door** (up to tyre width of 205 mm¹⁾)

Engine ²⁾	Z 14 XEP	Z 16 XER	Z 18 XER	Z 17 DTH
Manual transmission/Easytronic/Automatic transmission				
urban	8.0/ 7.7/-	8.7/ 8.5/-	9.9/-/10.5	6.4/-/-
extra-urban	5.0/ 4.9/-	5.2/ 5.0/-	5.8/-/ 6.2	4.2/-/-
total	6.1/ 5.9/-	6.5/ 6.3/-	7.3/-/ 7.8	5.0/-/-
CO ₂	146/ 142/-	156/ 151/-	175/-/ 187	135/-/-

¹⁾ On engine Z 17 DTH with Easytronic up to tyre width 195 mm.

²⁾ Sales designation, see pages 310 and 311.

Fuel consumption (approx. l/100 km), **CO₂ emissions** (approx. g/km), **Hatch 5-door** (up to tyre width of 225 mm¹⁾)

Engine ²⁾	Z 14 XEP	Z 16 XER	Z 16 LET	Z 18 XER
Manual transmission/Easytronic/Automatic transmission				
urban	8.2/ 7.9/-	8.9/ 8.7/-	10.3/-/-	10.1/-/10.7
extra-urban	5.2/ 5.1/-	5.4/ 5.2/-	6.2/-/-	6.0/-/ 6.4
total	6.3/ 6.1/-	6.7/ 6.5/-	7.7/-/-	7.5/-/ 8.0
CO ₂	151/ 146/-	161/ 156/-	185/-/-	180/-/ 192

Engine ²⁾	Z 17 DTH	Z 19 DT	Z 19 DTH
Manual transmission/Easytronic/Automatic transmission			
urban	6.5/-/-	7.4/-/ 9.7	7.4/-/-
extra-urban	4.3/-/-	4.9/-/ 5.4	4.9/-/-
total	5.1/-/-	5.8/-/ 7.0	5.8/-/-
CO ₂	138/-/-	157/-/ 189	157/-/-

¹⁾ For Z 17 DTH engine - tyre width up to 195 mm.

²⁾ Sales designation, see pages 310 and 311.

Fuel consumption (approx. l/100 km), **CO₂ emissions** (approx. g/km), **Hatch 3-door** (up to tyre width of 205 mm¹⁾)

Engine ²⁾	Z 14 XEP	Z 16 XER	Z 18 XER	Z 17 DTH
Manual transmission/Easytronic/Automatic transmission				
urban	8.0/ 7.7/-	8.7/ 8.5/-	9.9/-/10.4	6.4/-/-
extra-urban	5.0/ 4.9/-	5.2/ 5.0/-	5.8/-/ 6.1	4.2/-/-
total	6.1/ 5.9/-	6.5/ 6.3/-	7.3/-/ 7.7	5.0/-/-
CO ₂	146/ 142/-	156/ 151/-	175/-/ 185	135/-/-

1) For Z 17 DTH engine - tyre width up to 195 mm.

2) Sales designation, see pages 310 and 311.

Fuel consumption (approx. l/100 km), **CO₂ emissions** (approx. g/km), **Hatch 3-door** (up to tyre width of 225 mm¹⁾)

Engine ²⁾	Z 14 XEP	Z 16 XER	Z 16 LET	Z 18 XER
Manual transmission/Easytronic/Automatic transmission				
urban	8.2/ 7.9/-	8.9/ 8.7/-	10.3/-/-	10.1/-/10.6
extra-urban	5.2/ 5.1/-	5.4/ 5.2/-	6.2/-/-	6.0/-/ 6.3
total	6.3/ 6.1/-	6.7/ 6.5/-	7.7/-/-	7.5/-/ 7.9
CO ₂	151/ 146/-	161/ 156/-	185/-/-	180/-/ 190

Engine ²⁾	Z 20 LEH	Z 17 DTH	Z 19 DT	Z 19 DTH
Manual transmission/Easytronic/Automatic transmission				
urban	13.0/-/-	6.5/-/-	7.4/-/ 9.6	7.4/-/-
extra-urban	7.0/-/-	4.3/-/-	4.9/-/ 5.3	4.9/-/-
total	9.2/-/-	5.1/-/-	5.8/-/ 6.9	5.8/-/-
CO ₂	221/-/-	138/-/-	157/-/ 186	157/-/-

¹⁾ For Z 20 LEH engine - tyre width up to 235 mm.

²⁾ Sales designation, see pages 310 and 311.

Fuel consumption (approx. l/100 km), **CO₂ emissions** (approx. g/km), **Estate** (up to tyre width of 205 mm¹⁾)

Engine ²⁾	Z 14 XEP	Z 16 XER	Z 18 XER	Z 17 DTH
Manual transmission/Easytronic/Automatic transmission				
urban	8.0/-/-	8.8/ 8.6/-	10.0/-/10.5	6.4/-/-
extra-urban	5.0/-/-	5.3/ 5.1/-	5.9/-/ 6.2	4.2/-/-
total	6.1/-/-	6.6/ 6.4/-	7.4/-/ 7.8	5.0/-/-
CO ₂	146/-/-	158/ 154/-	178/-/ 187	135/-/-

1) For Z 17 DTH engine - tyre width up to 195 mm.

2) Sales designation, see pages 310 and 311.

Fuel consumption (approx. l/100 km), **CO₂ emissions** (approx. g/km), **Estate** (up to tyre width of 225 mm)

Engine ¹⁾	Z 14 XEP	Z 16 XER	Z 16 LET	Z 18 XER
Manual transmission/Easytronic/Automatic transmission				
urban	8.2/-/-	9.0/ 8.8/-	10.3/-/-	10.2/-/10.7
extra-urban	5.2/-/-	5.5/ 5.3/-	6.2/-/-	6.1/-/ 6.4
total	6.3/-/-	6.8/ 6.6/-	7.7/-/-	7.6/-/ 8.0
CO ₂	151/-/-	163/ 158/-	185/-/-	182/-/ 192

Engine ¹⁾	Z 17 DTH	Z 19 DT	Z 19 DTH
Manual transmission/Easytronic/Automatic transmission			
urban	6.5/-/-	7.5/-/ 9.7	7.5/-/-
extra-urban	4.3/-/-	5.0/-/ 5.4	5.0/-/-
total	5.1/-/-	5.9/-/ 7.0	5.9/-/-
CO ₂	138/-/-	159/-/ 189	159/-/-

¹⁾ Sales designation, see pages 310 and 311.

Fuel consumption (approx. l/100 km), **CO₂ emissions** (approx. g/km), **Van** (up to tyre width of 205 mm¹⁾)

Engine ²⁾	Z 14 XEP	Z 16 XER	Z 17 DTH
Manual transmission/Easytronic/Automatic transmission	8.0/-/-	8.8/ 8.6/-	6.4/-/-
urban	5.0/-/-	5.3/ 5.1/-	4.2/-/-
extra-urban	6.1/-/-	6.6/ 6.4/-	5.0/-/-
total	146/-/-	158/ 154/-	135/-/-
CO ₂			

1) For Z 17 DTH engine - tyre width up to 195 mm.

2) Sales designation, see pages 310 and 311.

Fuel consumption (approx. l/100 km), **CO₂ emissions** (approx. g/km), **Van** (up to tyre width of 225 mm)

Engine ¹⁾	Z 14 XEP	Z 16 XER	Z 17 DTH	Z 19 DT	Z 19 DTH
Manual transmission/Easytronic/Automatic transmission					
urban	8.2/-/-	9.0/ 8.8/-	6.5/-/-	7.4/-/ 9.7	7.4/-/-
extra-urban	5.2/-/-	5.5/ 5.3/-	4.3/-/-	4.9/-/ 5.4	4.9/-/-
total	6.3/-/-	6.8/ 6.6/-	5.1/-/-	5.8/-/ 7.0	5.8/-/-
CO ₂	151/-/-	163/ 158/-	138/-/-	157/-/ 189	157/-/-

Fuel consumption (approx. l/100 km), **CO₂ emissions** (approx. g/km), **TwinTop** (up to tyre width of 225 mm)

Engine ¹⁾	Z 16 XER	Z 16 LET	Z 18 XER	Z 19 DTH
Manual transmission/Easytronic/Automatic transmission				
urban	9.1/-/-	10.5/-/-	10.3/-/10.8	7.6/-/-
extra-urban	5.6/-/-	6.4/-/-	6.2/-/ 6.5	5.1/-/-
total	6.9/-/-	7.9/-/-	7.7/-/ 8.1	6.0/-/-
CO ₂	166/-/-	190/-/-	185/-/ 194	160/-/-

¹⁾ Sales designation, see pages 310 and 311.

Weights, payload and roof load

The payload is the difference between the permitted gross vehicle weight (see identification plate, page 308) and the EC kerbweight.

To calculate the kerbweight, enter the data for your vehicle below:

- kerbweight from table 1, page 327 + kg
 - Additional weight for equipment versions from table 2, page 334 + kg
 - Weight of heavy accessories from table 3, page 337 + kg
- Total = kg

is the EC kerbweight.

Optional equipment and accessories increase the kerbweight, which means that the payload will also change slightly.

Note the weights given in the vehicle documents.

The combined total of front and rear axle loads must not exceed the permissible gross vehicle weight. For example, if the front axle is bearing its maximum permissible load, the rear axle can only bear a load that is equal to the gross vehicle weight minus the front axle load.

With a connected trailer and full load on the towing vehicle including all passengers, in the Hatch the maximum permitted rear axle load (see rating plate or vehicle documents) may be exceeded by 65 kg (5-door) or 70 kg (3-door), and the maximum gross vehicle weight by 45 kg. In the Estate, the maximum permitted rear axle load may be exceeded by 60 kg and the maximum gross vehicle weight by 30 kg. If the maximum permitted rear axle load is exceeded, a top speed of 60 mph (100 km/h) applies. If lower top speeds are stipulated nationally when towing a trailer these must be observed.

See the identification plate or vehicle documents for permissible axle loads.

Roof load

The permissible roof load is 75 kg and 100 kg for caravan with roof railing. The roof load is the combined weight of the roof rack and the load.

No roof load is permitted with the Astra TwinTop or vehicles with a panoramic window.

Driving hints, see page 198. Roof racks, caravan and trailer towing, see page 232.

Table 1, kerbweight in kg¹⁾, Hatch 5-door

Model	Engine ²⁾	Manual transmission	Easytronic	Automatic transmission
Astra	Z 14 XEP	1240	1240	–
	Z 16 XER	1270	1270	–
	Z 18 XER	1278	–	1303
	Z 17 DTH	1365	–	–
	Z 19 DT	1395	–	1425
	Z 19 DTH	1393	–	–

¹⁾ According to EC Directive, including assumed weights for driver (68 kg), luggage (7 kg) and all fluids (tank 90% full).

²⁾ Sales designation, see pages 310 and 311.

Table 1, kerbweight in kg¹⁾, Hatch 5-door

Model	Engine ²⁾	Manual transmission	Easytronic	Automatic transmission
Astra with air conditioning system or climate control system	Z 14 XEP	1260	1260	–
	Z 16 XER	1290	1290	–
	Z 16 LET	1355	–	–
	Z 18 XER	1298	–	1323
	Z 17 DTH	1380	–	–
	Z 19 DT	1410	–	1440
	Z 19 DTH	1408	–	–

¹⁾ According to EC Directive, including assumed weights for driver (68 kg), luggage (7 kg) and all fluids (tank 90% full).

²⁾ Sales designation, see pages 310 and 311.

Table 1, kerbweight in kg¹⁾, Hatch 3-door

Model	Engine ²⁾	Manual transmission	Easytronic	Automatic transmission
Astra	Z 14 XEP	1220	1220	–
	Z 16 XER	1250	1250	–
	Z 18 XER	1265	–	1278
	Z 17 DTH	1345	–	–
	Z 19 DT	1375	–	1393
	Z 19 DTH	1390	–	–

¹⁾ According to EC Directive, including assumed weights for driver (68 kg), luggage (7 kg) and all fluids (tank 90% full).

²⁾ Sales designation, see pages 310 and 311.

Table 1, kerbweight in kg¹⁾, Hatch 3-door

Model	Engine ²⁾	Manual transmission	Easytronic	Automatic transmission
Astra with air conditioning system or climate control system	Z 14 XEP	1240	1240	–
	Z 16 XER	1270	1270	–
	Z 16 LET	1335	–	–
	Z 18 XER	1285	–	1298
	Z 20 LEH	1393	–	–
	Z 17 DTH	1360	–	–
	Z 19 DT	1390	–	1408
	Z 19 DTH	1405	–	–

¹⁾ According to EC Directive, including assumed weights for driver (68 kg), luggage (7 kg) and all fluids (tank 90% full).

²⁾ Sales designation, see pages 310 and 311.

Table 1, kerbweight in kg¹⁾, Estate

Model	Engine ²⁾	Manual transmission	Easytronic	Automatic transmission
Astra	Z 14 XEP	1278	–	–
	Z 16 XER	1315	1315	–
	Z 18 XER	1325	–	1350
	Z 17 DTH	1393	–	–
	Z 19 DT	1435	–	1465
	Z 19 DTH	1450	–	–

¹⁾ According to EC Directive, including assumed weights for driver (68 kg), luggage (7 kg) and all fluids (tank 90% full).

²⁾ Sales designation, see pages 310 and 311.

Table 1, kerbweight in kg¹⁾, Estate

Model	Engine ²⁾	Manual transmission	Easytronic	Automatic transmission
Astra with air conditioning system or climate control system	Z 14 XEP	1298	–	–
	Z 16 XER	1335	1335	–
	Z 16 LET	1395	–	–
	Z 18 XER	1345	–	1370
	Z 17 DTH	1408	–	–
	Z 19 DT	1450	–	1480
	Z 19 DTH	1465	–	–

¹⁾ According to EC Directive, including assumed weights for driver (68 kg), luggage (7 kg) and all fluids (tank 90% full).

²⁾ Sales designation, see pages 310 and 311.

Table 1, kerbweight in kg¹⁾, Van

Model	Engine ²⁾	Manual transmission	Easytronic	Automatic transmission
Astra	Z 14 XEP	1235	–	–
	Z 16 XER	1270	1270	–
	Z 17 DTH	1365	–	–
	Z 19 DT	1385	–	1420
	Z 19 DTH	1395	–	–
Astra with air conditioning system or climate control system	Z 14 XEP	1250	–	–
	Z 16 XER	1285	1285	–
	Z 17 DTH	1380	–	–
	Z 19 DT	1400	–	1435
	Z 19 DTH	1410	–	–

¹⁾ According to EC Directive, including assumed weights for driver (68 kg), luggage (7 kg) and all fluids (tank 90% full).

²⁾ Sales designation, see pages 310 and 311.

Table 1, kerbweight in kg¹⁾, TwinTop

Model	Engine ²⁾	Manual transmission	Easytronic	Automatic transmission
Astra	Z 16 XER	1495	1495	–
	Z 18 XER	1500	–	1503
	Z 19 DTH	1613	–	–
Astra with air conditioning system or climate control system	Z 16 XER	1515	1515	–
	Z 16 LET	1575	–	–
	Z 18 XER	1520	–	1523
	Z 19 DTH	1628	–	–

¹⁾ According to EC Directive, including assumed weights for driver (68 kg), luggage (7 kg) and all fluids (tank 90% full).

²⁾ Sales designation, see pages 310 and 311.

Table 2, additional weight for equipment versions in kg

Hatch

Engine ¹⁾	Z 14 XEP	Z 16 XER	Z 16 LET	Z 18 XER
Express / Life ²⁾	–	–	–	–
Club / Breeze	2.9	2.9	2.9	2.9
Design / Elite	12	12	12	12
SRi / Sxi	24.5	24.5	24.5	24.5
VXR ²⁾	–	–	–	–

Engine ¹⁾	Z 20 LEH	Z 17 DTH	Z 19 DT	Z 19 DTH
Express / Life ²⁾	–	–	–	–
Club / Breeze	–	2.9	2.9	2.9
Design / Elite	–	12	12	12
SRi / Sxi	–	24.5	12.6	12.6
VXR ²⁾	–	–	–	–

¹⁾ Sales designation, see pages 310 and 311.

²⁾ Values not available at time of printing.

Table 2, additional weight for equipment versions in kg
Estate

Engine¹⁾	Z 14 XEP	Z 16 XER	Z 16 LET	Z 18 XER
Express / Life ²⁾	–	–	–	–
Club / Breeze	2.9	2.9	2.9	2.9
Design / Elite	12	12	12	12
SRi / Sxi	24.5	24.5	24.5	24.5
VXR ²⁾	–	–	–	–

Engine¹⁾	Z 17 DTH	Z 19 DT	Z 19 DTH
Express / Life ²⁾	–	–	–
Club / Breeze	2.9	2.9	2.9
Design / Elite	12	12	12
SRi / Sxi	24.5	12.6	24.5
VXR ²⁾	–	–	–

1) Sales designation, see pages 310 and 311.

2) Values not available at time of printing.

Table 2, additional weight for equipment versions in kg

Van					
Engine ¹⁾	Z 14 XEP	Z 16 XER	Z 17 DTH	Z 19 DT	Z 19 DTH
Express / Life ²⁾	–	–	–	–	–
Club / Breeze	–	–	–	–	–
Design / Elite	–	–	–	–	–
Sport	19.3	10.5	10.5	10.5	10.5
VXR ²⁾	–	–	–	–	–

Table 3, heavy accessories in kg

Accessories	Sunroof	Towing equipment	Split rear seat bench
Weight	23	21 (except TwinTop) 26 (TwinTop)	20 (Estate) 9 (Hatch 3/5-door)

¹⁾ Sales designation, see pages 310 and 311.

²⁾ Values not available at time of printing.

Tyres

Not all tyres available on the market currently meet the structural requirements. We recommend that you consult a Vauxhall Authorised repairer concerning suitable tyre makes.

These tyres have undergone special tests to establish their reliability, safety and specific suitability for Vauxhall vehicles. Despite continuous market monitoring, we are unable to assess these attributes for other tyres, even if they have been granted approval by the relevant authorities or in some other form.

Further information, see page 225.

Winter tyres *

Tyres of size 215/45 R 17, 225/45 R 17, 225/40 R 18, 225/40 ZR 18 and 235/35 ZR 19 are not to be used as winter tyres.

Tyre sizes 215/45 R 17 are permitted as winter tyres only if the vehicle is factory-fitted with 18" wheels.

If you use winter tyres *, the spare wheel may still be fitted with a summer tyre. If you use the spare wheel the vehicle's handling may be altered. Obtain a replacement for the faulty tyre as soon as possible, and have the wheel balanced and fitted to the vehicle.

Winter tyres are permitted on the Astra VXR only on special Vauxhall-approved alloy wheels.

Further information, see page 231.

Tyre chains *

Tyre chains may be used on the front wheels only.

We recommend the use of fine-link snow chains which amount to max 10 mm on the tread and tyre inner wall with chain lock.

Tyre chains are not permitted on the emergency wheel 115/70 R 16 and on tyres of size 225/45 R 17, 225/40 R 18, 225/40 ZR 18 and 235/35 ZR 19.

Tyre chains are permitted on tyres size 215/45 R 17 only if the vehicle is factory-fitted with 18" wheels.

Further information, see page 232.

Wheels

Wheel bolt tightening torque: 110 Nm.

Spare wheel *

Depending on the version, the spare wheel may take the form of a temporary spare wheel *: vehicle driveability may be altered by use of the spare wheel. Obtain a replacement for the faulty tyre as soon as possible, and have the wheel balanced and fitted to the vehicle.

On vehicles with alloy wheels * the spare wheel may have a steel rim.

The spare wheel may be fitted with a smaller tyre¹⁾ and smaller wheel than the wheels fitted to the vehicle.

Tyre pressure in bar / psi²⁾

The specified tyre pressures are valid for cold tyres. The increased tyre pressure resulting from extensive driving must not be reduced. The tyre pressures specified on the following pages apply to both summer and winter tyres.

Always inflate the spare wheel * to the tyre pressure for full load – see tables on following pages.

Temporary spare wheel * tyre pressure – see tables on following pages.

In vehicles with tyre pressure monitoring system * there is an adapter in the valve cap key. Screw adapter to valve before attaching tyre pressure gauge, see page 227.

Further information, see pages 225 to 232.

¹⁾ Country-specific version: The spare wheel is only to be used as a temporary spare wheel.

²⁾ 1 bar corresponds to 100 kPa / 14.5 psi.

(ctd.)
Tyre pressure in bar / psi¹⁾

Engine ²⁾	Tyres	Hatch		Tyre pressure for load of up to 3 persons		Tyre pressure ECO ¹⁾ loaded with up to 3 people		Tyre pressure for full load	
		Front	Rear	Front	Rear	Front	Rear		
Z 14 XEP	185/65 R 15, 195/60 R 15	2.3/33	2.1/30	–	–	2.5/36	2.9/42		
	195/65 R 15, 205/55 R 16	2.0/29	2.0/29	2.5/36	2.5/36	2.1/30	2.5/36		
Z 16 XER	185/65 R 15, 195/60 R 15, 215/45 R 17, 225/40 R 18	2.3/33	2.1/30	–	–	2.5/36	2.9/42		
	195/65 R 15, 205/55 R 16, 225/45 R 17	2.0/29	2.0/29	2.5/36	2.5/36	2.1/30	2.5/36		
Z 16 LET	205/55 R 16, 225/45 R 17	2.3/33	2.1/30	2.7/39	2.5/36	2.5/36	2.9/42		
	215/45 R 17, 225/40 R 18	2.7/39	2.5/36	–	–	2.8/41	3.1/45		
all	T 115/70 R 16 (temporary spare) ³⁾	4.2/61	4.2/61	–	–	4.2/61	4.2/61		

1) To achieve the smallest amount of fuel consumption possible. Not for use with run-flat tyres.

2) Sales designation, see pages 310 and 311.

3) For notes on the temporary spare wheel, see page 250.

1) 1 bar corresponds to 100 kPa / 14.5 psi.

(ctd.)
Tyre pressure in bar / psi¹⁾

Hatch		Tyre pressure for load of up to 3 persons		Tyre pressure ECO ¹⁾ loaded with up to 3 people		Tyre pressure for full load	
Engine ²⁾	Tyres	Front	Rear	Front	Rear	Front	Rear
Z 18 XER	185/65 R 15, 195/60 R 15, 215/45 R 17, 225/40 R 18	2.3/33	2.1/30	–	–	2.5/36	2.9/42
	195/65 R 15, 205/55 R 16	2.0/29	2.0/29	2.5/36	2.5/36	2.1/30	2.5/36
	225/45 R 17	2.3/33	2.1/30	2.7/39	2.5/36	2.5/36	2.9/42
Z 20 LEH	205/50 R 17 ³⁾ , 225/40 ZR 18, 235/35 ZR 19, 225/45 R 17 ⁴⁾	2.4/35	2.4/35	–	–	2.5/36	2.9/42
all	T 115/70 R 16 (temporary spare) ⁵⁾	4.2/61	4.2/61	–	–	4.2/61	4.2/61

1) To achieve the smallest amount of fuel consumption possible. Not for use with run-flat tyres.

2) Sales designation, see pages 310 and 311.

3) Only permitted as winter tyres.

4) To guarantee a correct speed display, the electronic speedometer must be reprogrammed.

5) For notes on the temporary spare wheel, see page 250.

1) 1 bar corresponds to 100 kPa / 14.5 psi.

340 Technical data

(ctd.)
Tyre pressure in bar / psi¹⁾

Hatch		Tyre pressure for load of up to 3 persons		Tyre pressure ECO ¹⁾ loaded with up to 3 people		Tyre pressure for full load	
Engine ²⁾	Tyres	Front	Rear	Front	Rear	Front	Rear
Z 17 DTH	195/65 R 15, 205/55 R 16, 225/45 R 17	2.1/30	2.1/30	2.5/36	2.5/36	2.5/36	2.9/42
	215/45 R 17, 225/40 R 18	2.5/36	2.3/33	–	–	2.6/38	3.0/44
Z 19 DT, Z 19 DTH	205/55 R 16, 225/45 R 17	2.3/33	2.1/30	2.7/39	2.5/36	2.5/36	2.9/42
	215/45 R 17, 225/40 R 18	2.7/39	2.5/36	–	–	2.8/41	3.1/45
all	T 115/70 R 16 (temporary spare) ³⁾	4.2/61	4.2/61	–	–	4.2/61	4.2/61

1) To achieve the smallest amount of fuel consumption possible. Not for use with run-flat tyres.

2) Sales designation, see pages 310 and 311.

3) For notes on the temporary spare wheel, see page 250.

1) 1 bar corresponds to 100 kPa / 14.5 psi.

(ctd.)
Tyre pressure in bar / psi¹⁾

Estate		Tyre pressure for load of up to 3 persons		Tyre pressure ECO ¹⁾ loaded with up to 3 people		Tyre pressure for full load	
Engine ²⁾	Tyres	Front	Rear	Front	Rear	Front	Rear
Z 14 XEP	195/65 R 15, 205/55 R 16	2.0/29	2.0/29	2.5/36	2.5/36	2.1/30	2.6/38
	185/65 R 15, 195/60 R 15	2.3/33	2.1/30	–	–	2.5/36	2.9/42
Z 16 XER	195/65 R 15, 205/55 R 16, 225/45 R 17	2.0/29	2.0/29	2.5/36	2.5/36	2.1/30	2.6/38
	185/65 R 15, 195/60 R 15, 215/45 R 17, 225/40 R 18	2.3/33	2.1/30	–	–	2.5/36	2.9/42
Z 16 LET	205/55 R 16, 225/45 R 17	2.3/33	2.1/30	2.7/39	2.5/36	2.5/36	2.9/42
	215/45 R 17, 225/40 R 18	2.7/39	2.5/36	–	–	2.8/41	3.1/45
all	T 115/70 R 16 (temporary spare) ³⁾	4.2/61	4.2/61	–	–	4.2/61	4.2/61

1) To achieve the smallest amount of fuel consumption possible. Not for use with run-flat tyres.

2) Sales designation, see pages 310 and 311.

3) For notes on the temporary spare wheel, see page 250.

1) 1 bar corresponds to 100 kPa / 14.5 psi.

342 Technical data

(ctd.)
Tyre pressure in bar / psi¹⁾

Engine ²⁾	Tyres	Estate		Tyre pressure for load of up to 3 persons		Tyre pressure ECO ¹⁾ loaded with up to 3 people		Tyre pressure for full load	
		Front	Rear	Front	Rear	Front	Rear		
Z 18 XER	195/65 R 15, 205/55 R 16, 225/45 R 17	2.0/29	2.0/29	2.5/36	2.5/36	2.1/30	2.6/38		
	185/65 R 15, 195/60 R 15, 215/45 R 17, 225/40 R 18	2.3/33	2.1/30	–	–	2.5/36	2.9/42		
Z 17 DTH	195/65 R 15 ³⁾ , 205/55 R 16, 225/45 R 17	2.1/30	2.1/30	2.5/36	2.5/36	2.5/36	2.9/42		
	215/45 R 17, 225/40 R 18	2.5/36	2.3/33	–	–	2.6/38	3.0/44		
Z 19 DT, Z 19 DTH	205/55 R 16, 225/45 R 17	2.3/33	2.1/30	2.7/39	2.5/36	2.5/36	2.9/42		
	215/45 R 17, 225/40 R 18	2.7/39	2.5/36	–	–	2.8/41	3.1/45		
all	T 115/70 R 16 (temporary spare) ³⁾	4.2/61	4.2/61	–	–	4.2/61	4.2/61		

1) To achieve the smallest amount of fuel consumption possible. Not for use with run-flat tyres.

2) Sales designation, see pages 310 and 311.

3) For notes on the temporary spare wheel, see page 250.

1) 1 bar corresponds to 100 kPa / 14.5 psi.

(ctd.)
Tyre pressure in bar / psi¹⁾

Van	Engine ²⁾	Tyres	Tyre pressure for load of up to 3 persons		Tyre pressure ECO ¹⁾ loaded with up to 2 people		Tyre pressure for full load	
			Front	Rear	Front	Rear	Front	Rear
Z 14 XEP		195/65 R 15, 205/55 R 16	2.0/29	2.0/29	2.5/36	2.5/36	2.1/30	2.6/38
		185/65 R 15, 195/60 R 15	2.3/33	2.1/30	–	–	2.5/36	2.9/42
Z 17 DTH		195/65 R 15, 205/55 R 16, 225/45 R 17	2.1/30	2.1/30	2.5/36	2.5/36	2.5/36	2.9/42
		215/45 R 17, 225/40 R 18	2.5/36	2.3/33	–	–	2.6/38	3.0/44
Z 19 DT, Z 19 DTH		205/55 R 16, 225/45 R 17	2.3/33	2.1/30	2.7/39	2.5/36	2.5/36	2.9/42
		215/45 R 17, 225/40 R 18	2.7/39	2.5/36	–	–	2.8/41	3.1/45
all		T 115/70 R 16 (temporary spare) ³⁾	4.2/61	4.2/61	–	–	4.2/61	4.2/61

1) To achieve the smallest amount of fuel consumption possible. Not for use with run-flat tyres.

2) Sales designation, see pages 310 and 311.

3) For notes on the temporary spare wheel, see page 250.

1) 1 bar corresponds to 100 kPa / 14.5 psi.

(ctd.)
Tyre pressure in bar / psi¹⁾

TwinTop		Tyre pressure for load of up to 3 persons		Tyre pressure ECO ¹⁾ loaded with up to 3 people		Tyre pressure for full load	
Engine ²⁾	Tyres	Front	Rear	Front	Rear	Front	Rear
Z 16 XER, Z 18 XER	205/55 R 16, 225/45 R 17	2.1/30	2.1/30	2.5/36	2.5/36	2.2/32	2.6/38
	225/40 R 18	2.3/33	2.1/30	–	–	2.4/35	2.8/41
Z 16 LET	205/55 R 16, 225/45 R 17	2.3/33	2.1/30	–	–	2.4/35	2.8/41
	225/40 R 18	2.5/36	2.3/33	–	–	2.6/38	3.0/44
Z 19 DTH	205/55 R 16, 225/45 R 17	2.3/33	2.1/30	–	–	2.4/35	2.8/41
	225/40 R 18	2.5/36	2.3/33	–	–	2.6/38	3.0/44
all	T 115/70 R 16 (temporary spare) ³⁾	4.2/61	4.2/61	–	–	4.2/61	4.2/61

1) To achieve the smallest amount of fuel consumption possible. Not for use with run-flat tyres.

2) Sales designation, see pages 310 and 311.

3) For notes on the temporary spare wheel, see page 250.

1) 1 bar corresponds to 100 kPa / 14.5 psi.

Electrical system

Battery	Voltage	12 Volt
	Amp hours	36 Ah / 44 Ah * / 55 Ah * / 60 Ah * / 66 Ah * / 70 Ah * / 72 Ah *

Battery for remote control of central locking system and electronic key of Open&Start system CR 20 32

346 Technical data

Capacities

(approx. litres)

Engine ¹⁾	Z 14 XEP	Z 16 XER	Z 16 LET	Z 18 XER
Fuel tank (nominal content)	52	52	52	52
Engine oil with filter change between MIN and MAX on oil dipstick	3.5 1.0	4.5 1.0	4.5 1.0	4.5 1.0
Container for windscreen wash system with headlight wash system	2.4 4.0	2.4 4.0	2.4 4.0	2.4 4.0

Engine ¹⁾	Z 17 DTH	Z 19 DT	Z 19 DTH
Fuel tank (nominal content)	52	52	52
Engine oil with filter change between MIN and MAX on oil dipstick	5.0 1.0	4.3 1.0	4.3 1.0
Container for windscreen wash system with headlight wash system	2.4 4.0	2.4 4.0	2.4 4.0

¹⁾ Sales designation, see pages 310 and 311.

Dimensions

(approx. mm)

	Hatch 5-door	Hatch 3-door	Estate	Van	TwinTop
Overall length	4249	4290	4515	4515	4476
Width	1753	1753	1753	1753	1759
Width with two exterior mirrors	2032	2032	2032	2032	2021
Overall height ¹⁾	1460	1435	1500	1500	1411
Length of luggage compartment floor	819	819	1085	1825	805
Luggage compartment width	944	944	1088	1103	734
Height of luggage compartment opening	614	555	766	775	–
Wheelbase	2614	2614	2703	2703	2614
Turning circle diameter ²⁾	11.20	11.20	11.50	11.50	11.20

¹⁾ kerbweight with driver.

²⁾ In metres.

Installation dimensions of trailer towing equipment with detachable coupling ball bar, Hatch¹⁾

All dimensions refer to factory-fitted towing equipment.

Dimension	mm
A	342.9
B	83
C	513.4
D	488.6
E	211.4
F	94.3
G	160

Warning

Only use towing equipment approved for your vehicle. We recommend entrusting fitting of towing equipment at a later date to a workshop.

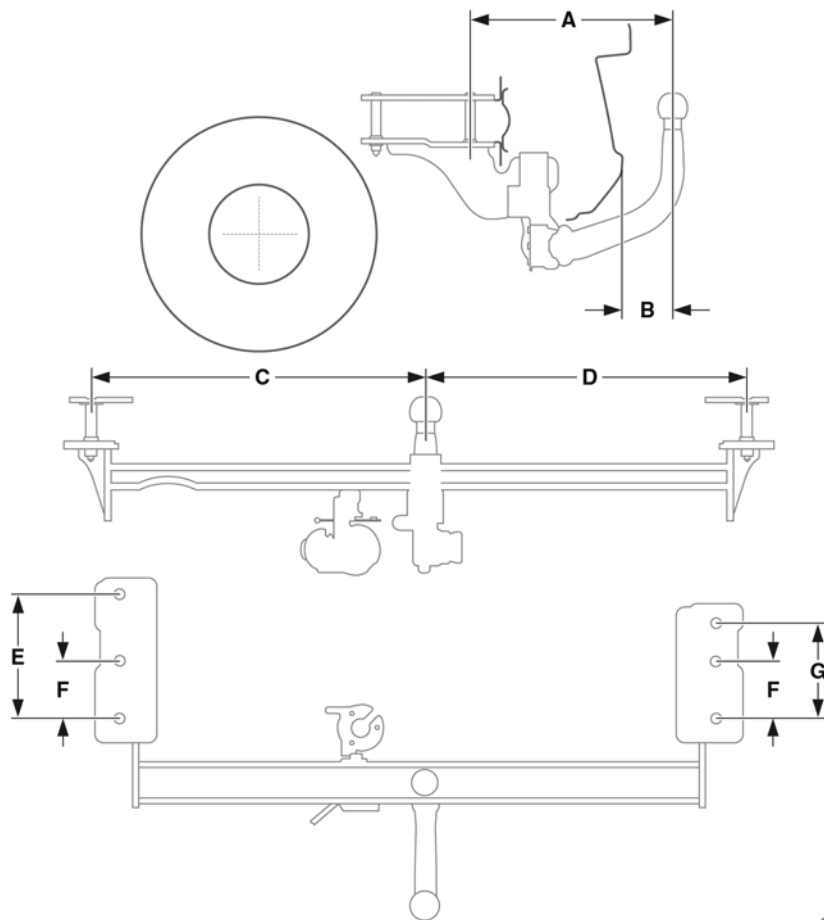

¹⁾ Do not mount towing equipment to vehicles with Z 20 LEH engine. Sales designation, see page 310.

Installation dimensions of trailer towing equipment with detachable coupling ball bar, Estate, Van

All dimensions refer to factory-fitted towing equipment.

Dimension	mm
A	84.0
B	570.0
C	515.0
D	93.5
E	173.0
F	307.6
G	158.0
H	292.6

Warning

Only use towing equipment approved for your vehicle. We recommend entrusting fitting of towing equipment at a later date to a workshop.

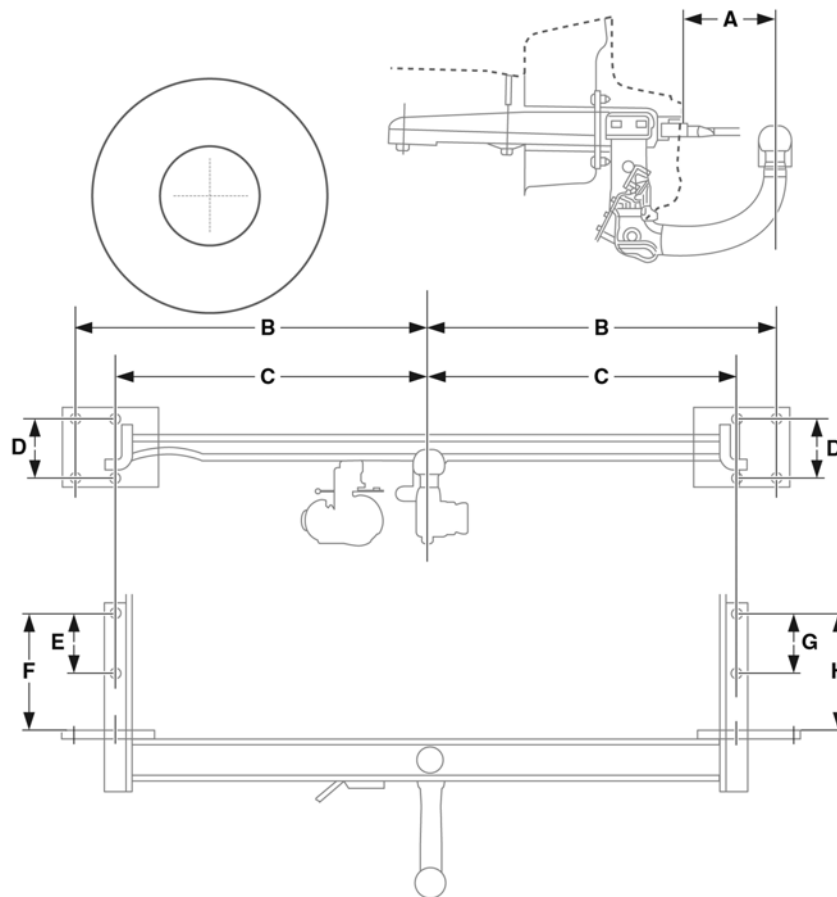

Installation dimensions of towing equipment with detachable coupling ball bar, Astra TwinTop

All measurements refer to Vauxhall-approved towing equipment.

Dimension	mm
A	68.8
B	570.0
C	515.0
D	485.0
E	93.5
F	288.0
G	245.0

Warning

Only use towing equipment approved for your vehicle. We recommend entrusting fitting of towing equipment at a later date to a workshop.

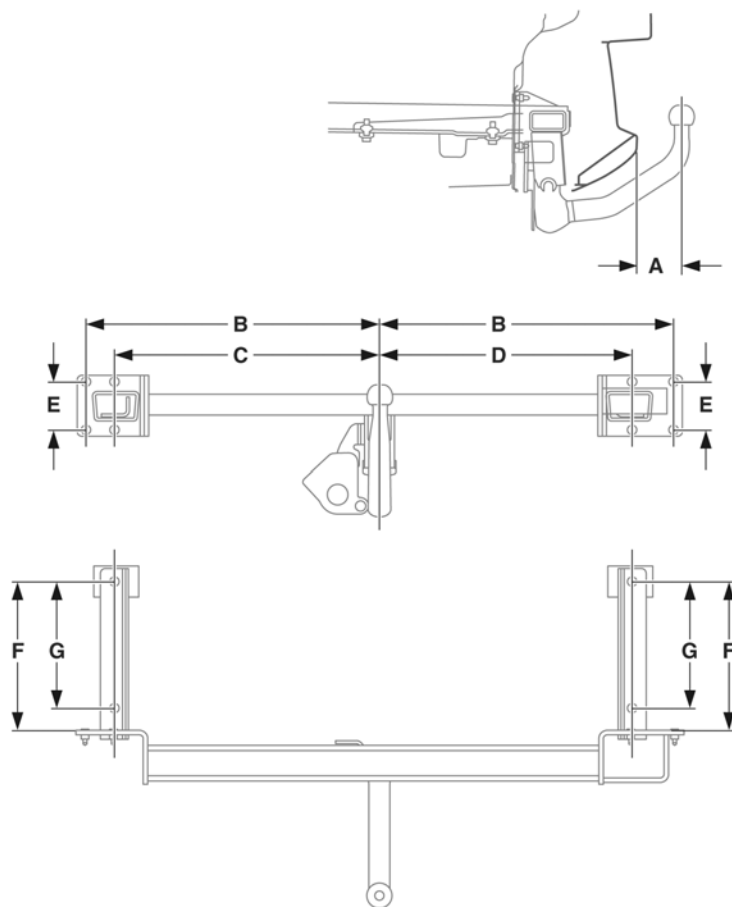

Index

A

ABS (Anti-lock Brake System) 224
 Accessories..... 90, 247
 Accessory socket 107
 ActiveSelect..... 16
 Adaptive Forward Lighting (AFL) .. 26, 147
 Bulb replacement..... 273
 Driving abroad..... 150
 Air conditioning system..... 154, 161
 Air intake 174
 Air quality sensor 169
 Air recirculation system..... 161, 165, 173
 Air vents 156
 Airbags 92
 Alarm system 46
 Alternator 115
 Antenna..... 140, 151, 289
 Anti-dazzle interior mirror..... 51
 Antifreeze 300, 301
 Antifreeze protection 301, 305
 Anti-knock quality of fuel..... 202
 Anti-theft locking system 41
 Towing equipment..... 235
 Anti-theft protection 18
 Aquaplaning 230
 Armrest..... 70, 110
 Ashtray 108, 150
 Aspherical exterior mirror 49
 Automatic air recirculation mode 169, 173
 Automatic anti-dazzle interior mirror 51

Automatic transmission 15, 16
 Automatic mode..... 184, 191
 Control indicator..... 185, 192
 Driving programme 185, 192
 Fault..... 188, 196
 Interruption of power supply 189, 197
 Kickdown 187, 194
 Manual mode..... 192
 Selector lever..... 15, 16, 184, 191, 192
 Winter programme 186, 193

Automatic transmission
 with ActiveSelect..... 16
 Automatic wiping 12, 141

B

Battery..... 199, 306, 345
 Interruption of
 power supply..... 183, 189, 197
 Battery discharge protection 150
 Before starting off 16
 Belt force limiters..... 86
 Belt tensioners 86
 Bleeding, diesel fuel system..... 241
 Board information display..... 122, 128
 Bonnet 241
 Boot, see Luggage compartment.... 44, 71
 Brake assist 223
 Brake fluid 309
 Brake system..... 222

Brakes

ABS 224
 Brake assist 223
 Brake fluid..... 302
 Brake lights 277, 283
 Brake servo unit..... 198
 Footbrake..... 223
 Handbrake..... 224
 Bulb replacement..... 267, 269
 Bulbs..... 267, 269

C

Capacities 346
 Car Pass 30
 Caravan/trailer towing..... 198, 237
 Cargo box 81
 Catalytic converter..... 209, 242
 CDC (Continuous Damping Control) .. 115,
 211
 Central locking system..... 40
 Cetane numbers..... 311
 Changing the battery
 Remote control 34, 345
 Changing tyre/wheel type 225
 Changing wheels 252
 Chassis number, see vehicle identification
 number 309
 Check control..... 22, 138
 Child restraint system 90
 Child safety locks 49, 52, 53
 Cigarette lighter 107, 150
 Climate control 154
 Climate control system 155, 168
 Clock..... 120

- Clutch operation 199
CO2 emissions..... 316
Cold start..... 199
Colour information display .. 122, 130, 134
Continuous Damping
 Control (CDC)..... 115, 211
Contrast..... 133
Control indicators 10, 112, 113
 ABS (Anti-lock Brake System) 225
 Adaptive Forward Lighting (AFL) ... 118, 147
 Airbag..... 98, 105
 Belt tensioners..... 87
 Brake system 224
 Cruise control 214
 DDS 219
 Deflation detection system 219
 Engine electronics 206
 ESP (Electronic Stability Program) 210
 Exhaust..... 206
 IDS+ 212, 213
 Immobiliser 31
 Parking distance sensor 216
 Transmission 185, 192
 Tyre pressure monitoring system 221
Coolant..... 300, 309
Coolant level 301
Coolant temperature..... 115
Cooled glove compartment..... 156
Cooling 162, 167
Correcting time 126, 132
Coupling socket load..... 238
- Courtesy light..... 148
 Bulb replacement 287
Cruise control..... 213
Curtain airbags..... 97
Curve lighting 26, 147
- D**
- Dashboard, see Instrument panel 7
Data..... 30, 308
Date..... 124, 127
Daytime running lights..... 143
Decommissioning 307
Deflation detection system (DDS).. 25, 218
Demisting and defrosting
 Windows..... 160
 With climate control system 171
 With the air conditioning system..... 163, 167
Diesel 311
Diesel fuel filter 300
Diesel fuel system 241, 300
Diesel particle filter..... 118, 157, 199
Dimensions..... 347
Dipped beam..... 11
 Bulb replacement 270, 273
Display..... 121, 122
Documents..... 308
Door handle lighting 149
Door locks 30, 291
Doors 115
Door-to-door light function 148
Driving abroad 202, 295
 Headlights..... 150
Driving hints 198
- E**
- Easy Load 82
Easytronic 15
 Driving programmes 179
 Fault 182
 Interruption of power supply 183
 Kickdown..... 180
 Selector lever..... 15
 Starting off 178
 Winter programme..... 180
Economical driving..... 200
Electric sunroof 54
Electrical exterior mirrors..... 6
Electrical system 306, 345
Electro-hydraulic
 power assisted steering 198
Electronic components..... 306
Electronic immobiliser 31
Electronic Stability Program 210
Engine code 309, 310, 311
Engine control indicator 206
Engine data 310, 311
Engine oil 298
Engine oil change..... 299
Engine oil consumption 298
Engine oil filter 300
Engine oil level..... 116, 298
Engine oil pressure 113
Engine speed 199
Engine wash..... 292
Entry lighting 149
Environmental protection..... 300
ESP (Electronic Stability Program) 210

- Exhaust control indicator 206
 Exhaust gases 207
 Exhaust system 207
 Exterior lights 116, 143
 Exterior mirrors 6, 49, 157
- F**
- Fan 158, 297
 Filling station
 Capacities 346
 Engine oil level 298
 Fuel 202, 310, 311
 Opening the bonnet 241
 Tyre pressure 201, 337
 Vehicle data 309
 Windscreen wash system 305
 First-aid kit (cushion) 247
 Flat tyre 256
 FlexOrganizer 80
 Fog lights 145
 Bulb replacement 276
 Fog tail light 145
 Bulb replacement 277, 283
 Folding roof, see TwinTop 56
 Folding the backrest 66
 Footbrake 223
 Front airbags 93
 Front passenger airbag 93
 Fuel 202, 310, 311
 Fuel consumption . 200, 202, 316, 321, 324
 Fuel filler cap 203
 Fuel filter 300
 Fuel gauge 119
 Fuel level 119
- Fuel system, diesel 241
 Fuse extractor 261
 Fuses 259
- G**
- Gears 14
 Generator, see Alternator 115
 Genuine Vauxhall Parts
 and Accessories 297
 Glasses compartment 111
 Glove compartment 110
 Cooled 156
 Glove compartment lighting 149
 Bulb replacement 288
 Graphical information
 display 122, 130, 134
 Gross vehicle weight 325
 Gross vehicle weight rating 325
- H**
- Halogen headlight system 269
 Bulb replacement 269
 Driving abroad 150
 Handbrake 18, 224
 Hazard warning lights 11, 146
 Head restraints 21, 69
 Head rests 21
 Headlight flash 144
 Headlight range adjustment 146, 269
 Headlight switch 7, 143, 144
 Headlight wash system 13, 142, 305
- Headlights 7
 Daytime running lights 143
 Driving abroad 150
 Fog lights 145
 Reverse lights 145
 Warning device 140
 Heated exterior mirrors 13, 157
 Heated front seats 157
 Heated rear window 13, 157
 Heating 154, 159
 Seats 157
 With climate control system 170
 with the air conditioning
 system 163, 167
 Height adjustment
 Seat belts 88
 Steering wheel 7
 High-pressure cleaners 236, 291, 293
 Hill Start Assist 223
 Horn 12
- I**
- Identification plate 308
 IDS+ (Interactive Driving System). 209, 211
 Ignition logic 127, 134
 Ignition system 297, 306
 Ignition, see Starter switch 6, 7
 Immobiliser 31
 Information display 122
 Infotainment system 151
 Inspection system 296
 Instrument display 119

- Instrument illumination 148
 Bulb replacement..... 288
- Instrument panel 7
- Instruments 112
- Interactive Driving System (IDS+) . 209, 211
- Interior mirror 5, 51
- Interruption of power supply 136, 139
 Easytronic 183
 Selector lever lock 189, 197
- ISOFIX 91
- J**
- Jack 251
- Jump leads 243
- K**
- Kerbweight 327 - 333
- Keys 30
 Extending 30
 Ignition lock 6, 7
 Locking doors 40
 Remove 18
 Replacement 30
 Starting the engine 6, 7, 17
- L**
- Language selection 127, 132
- Lashing eyes 80
- Leather trim 291
- Level control system 217
- Light switch 7
- Lighting 7, 116, 143
 Driving abroad 150
- Loading 237, 321, 322, 324
- Locking doors 40
- Locking from the inside 42
- Locks 291
- Lubricants 298, 309
- Luggage compartment
 Blind 82
 Bulb replacement 288
 FlexOrganizer 80
 Grille 79
 Lighting 149
 Loading 84, 237, 325
 Locking 44
 Safety net 78, 79
- Luggage compartment cover 76
- Lumbar support 66
- M**
- Main beam 11, 144
 Bulb replacement 271, 273
 Control indicator 117
- Maintenance
 Air conditioning system 175
 Antifreeze protection 301
 Brake fluid 302
 Brakes 222
 Catalytic converter 209
 Engine oil 298, 300
 Fuel consumption 201
 Tyre pressure 227
 Tyres 228, 229
 Windscreen wiper 303
- Manual transmission, see Transmission 14
- Mechanical anti-theft locking 41
- Mirrors 5, 49, 51
- Misted windows 160, 171
- Mobile telephone 152
- Motorway lighting 26, 147
- N**
- Neutral, transmission 14
- Number plate lighting 286
- Number plate lights
 Bulb replacement 286
- Number plates 307
- O**
- Octane numbers 202, 310
- Odometer, see Trip odometer 120
- Oil change 300
- Oil consumption 298
- Oil filter change 300
- Oil level 298
- Oil pressure 113
- Oils 298, 309
- Open&Start system 17, 24, 34, 112
- Operating temperature 199
- Outside temperature gauge 123
- Overrun 199, 201
- P**
- Paintwork damage 290
- Panoramic windscreen 26, 53
- Parking 18, 215
- Parking distance sensor 215
- Parking lights 7, 143
 Bulb replacement 272, 275
- Parking the vehicle 18
- Pedals 199

Performance..... 316
 Petrol 202, 310
 Pinking 202
 Pollen filter 174
 Power assisted steering, see
 electro-hydraulic power
 assisted steering 198
 Preheating..... 17, 118
 Preheating switch 17
 Pushing, towing 242

Q

Quickheat..... 159, 166, 170

R

Radio 140, 151
 Radio equipment (CB)..... 152
 Radio reception 140, 151
 Rain sensor..... 12, 141, 303
 Reading lights..... 149
 Rear light cluster..... 143
 Bulb replacement..... 277, 283
 Rear screen wiper 142
 Rear window wash
 system..... 13, 142, 289, 305
 Recommissioning..... 307
 Refuelling..... 203
 Fuel filler cap..... 203
 Remote control
 Central locking system 2, 24, 32, 36
 Steering wheel..... 23, 151
 Replacement keys 30

Reverse lights
 Bulb replacement 277, 283
 Rollover protection system 59
 Roof lining 26, 53
 Roof load..... 84, 198, 201, 321, 322, 324
 Roof rack..... 201, 232, 325
 Roof racks 201, 325
 Run-flat tyres 230
 Running-in
 Brakes..... 222

S

Safeguard against
 unauthorised use 6, 7, 19
 Safety accessories 90, 247
 Safety net..... 78, 79
 Save energy - more miles 198
 Saving energy..... 200
 Seat adjustment 3, 64
 Seat belts 88, 291
 Seat height adjustment 4, 65
 Seat occupancy recognition..... 99
 Seat position 67
 Seats 3, 64, 66
 Heated..... 157
 Selector lever..... 177, 184, 191
 Selector lever lock..... 15, 16, 184, 191
 Self-diagnosis 87, 98
 Self-help 241
 Automatic transmission 189
 Electric sunroof 55
 Information display 124
 Remote control 33, 39

Service interval display 296
 Service work 296
 Service, maintenance..... 294
 Side airbags..... 95
 Signal system..... 12
 Silencer, see Exhaust system 207
 Spare fuses 260
 Spare keys..... 30
 Spare wheel 249, 250, 252
 Speed 200, 201
 Fuel consumption 200, 201
 Speedometer 119
 Sport mode 115
 Sport programme..... 24, 212
 Starter switch..... 6, 7
 Starting the engine ... 6, 7, 17, 31, 177, 242
 Self-help 242
 Steam-jet cleaners 236, 291, 293
 Steering column lock..... 6, 7, 18
 Steering wheel adjustment 7
 Steering wheel remote control 23, 151
 Stowage compartments 110
 Sun visors 26, 53, 111, 149
 Sunblind 54
 Sunroof..... 54
 System settings..... 126, 131

T

Tables..... 110
 Tachometer 119
 Tail lights..... 143
 Bulb replacement 277, 283
 Tailgate..... 44

- Tank
 Fuel gauge 119
- Technical data 308
- Telephone, see Mobile telephone 152
- Temperature regulation..... 158, 170
- Temporary spare wheel 232, 250
- Tightening torque 255, 337
- Tilt angle
 Seats 4, 65
- Time 124, 127
- Tools 251
- Towing equipment 233, 348, 349, 350
- Towing eye 244, 246
- Trailer Stability Assist (TSA) 239
- Transmission display ... 121, 176, 184, 190
- Transmission, automatic..... 15, 16
 Automatic mode..... 184, 191
 Driving programme 185, 192
 Fault 188, 196
 Interruption of power supply ... 189, 197
 Kickdown 187, 194
 Selector lever 15, 184, 191, 192
 Selector lever lock 15
 Winter programme 186, 193
- Transmission, Easytronic
 Driving programmes..... 179
 Fault 182
 Interruption of power supply 183
 Kickdown 180
 Selector lever 15, 178
 Winter programme 180
- Transmission, manual 14
- Tread depth 229
- Trip computer 22, 128, 134
- Trip odometer..... 120
- Triple information display..... 122, 124
- TSA (Trailer Stability Assist)..... 239
- Turn signal lights 11
- Turn signals
 Bulb replacement 276, 277, 283
- Twin Audio 23, 152
- TwinTop 56
 Closing the roof 57
 Opening the roof 56
 Rollover protection 59
 Warning buzzers..... 58
 Wind deflector 61
- Tyre chains..... 232, 337
- Tyre condition..... 228
- Tyre pressure 25, 219, 227, 337
- Tyre pressure monitoring system ... 25, 219
- Tyre repair kit 256
- U**
- Units of measure 127, 133
- Unleaded fuel 202, 204, 310
- Used oil..... 300
- V**
- Valve cap key 227, 337
- Vauxhall alarm system 46, 306
- Vauxhall Full Size airbag system 93
- Vauxhall service 294
- Vehicle care 289
- Vehicle decommissioning 307
- Vehicle dimensions..... 347
- Vehicle identification number 309
- Vehicle recommissioning 307
- Vehicle storage..... 307
- Vehicle tools 251
- Ventilation 154, 159, 166, 172
- W**
- Warning buzzers 140
- Warning messages..... 125, 130, 138
- Warning triangle 247
- Wash fluid reservoir,
 Windscreen wash system..... 305
- Weights 321, 322, 324
- Wheels..... 225
- Wheels, tyres..... 225
- Wind deflector 61
- Windows
 Demisting and
 defrosting..... 160, 163, 167, 171
- Windscreen wash system..... 13, 142
 Antifreeze protection 305
 Capacities 346
 Wash fluid reservoir..... 305
- Windscreen wiper 12, 141, 303

Winter mode	
Starting-off aid	180
Winter operation	
Battery	199
Coolant, antifreeze	301
Fuel consumption	201
Fuel for diesel engines	202
Heating	154, 163, 167
Locks	291
Tyre chains	232, 337
Window demisting and defrosting	160
Windscreen wash system, antifreeze protection	305
Winter programme	180, 186, 193
Winter tyres	231, 337

X

Xenon headlight system	26, 146, 273
Bulb replacement	273
Driving abroad	150



©Copyright by Vauxhall Motors Ltd., England.

Reproduction or translation, in whole or in parts, is not permitted without prior written consent from Vauxhall Motors Ltd.

All rights as understood under the copyright laws are explicitly reserved by Vauxhall Motors Ltd.

All information, illustrations and specifications contained in this manual are based on the latest production information available at the time of publication.

The right is reserved to make changes at any time without notice.

Edition: July 2007.

TS 1612-A-08

