



New Crossland

Owner's Manual

Contents

Introduction	2
In brief	6
Keys, doors and windows	20
Seats, restraints	40
Storage	61
Instruments and controls	69
Lighting	102
Climate control	111
Driving and operating	122
Vehicle care	177
Service and maintenance	218
Technical data	224
Customer information	234
Index	242

Introduction

Fuel	Designation	<input type="text"/>		
Engine oil	Grade	<input type="text"/>		
	Viscosity	<input type="text"/>		
Tyre pressure	Tyre size		Front	Rear
	Summer tyres	<input type="text"/>	<input type="text"/>	<input type="text"/>
	Winter tyres	<input type="text"/>	<input type="text"/>	<input type="text"/>
Weights	Gross vehicle weight rating	<input type="text"/>		
	- Kerb weight, basic model	<input type="text"/>		
	= Loading	<input type="text"/>		

Vehicle specific data

Please enter your vehicle's data on the previous page to keep it easily accessible.

Please refer to the sections "Service and maintenance", "Technical data", the vehicle's identification plate and national registration documents.

Introduction

Your vehicle is a designed combination of advanced technology, safety, environmental friendliness and economy.

This Owner's Manual provides you with all the necessary information to enable you to drive your vehicle safely and efficiently.

Make sure your passengers are aware of the possible risk of accident and injury which may result from improper use of the vehicle.

You must always comply with the specific laws and regulations of the country that you are in. These laws may differ from the information in this Owner's Manual.

Disregarding the description given in this manual may affect your warranty.

When this Owner's Manual refers to a workshop visit, we recommend your Vauxhall Authorised Repairer.

All Vauxhall Authorised Repairers provide first-class service at reasonable prices. Experienced mechanics trained by Vauxhall work according to specific Vauxhall instructions.

The customer literature pack should always be kept ready to hand in the vehicle.

Using this manual

- This manual describes all options and features available for this model. **Certain descriptions, including those for display and menu functions, may not apply to your vehicle due to model variant, country specifications, special equipment or accessories.**
- The "In brief" section will give you an initial overview.

- The table of contents at the beginning of this manual and within each section shows where the information is located.
- The index will enable you to search for specific information.
- This Owner's Manual depicts left-hand drive vehicles. Operation is similar for right-hand drive vehicles.
- The Owner's Manual uses the engine identifier code. The corresponding sales designation and engineering code can be found in the section "Technical data".
- Directional data, e.g. left or right, or front or back, always relate to the direction of travel.
- Displays may not support your specific language.
- Display messages and interior labelling are written in **bold** letters.

Danger, Warnings and Cautions

Danger

Text marked **⚠ Danger** provides information on risk of fatal injury. Disregarding this information may endanger life.

Warning

Text marked **⚠ Warning** provides information on risk of accident or injury. Disregarding this information may lead to injury.

Caution

Text marked **Caution** provides information on possible damage to the vehicle. Disregarding this information may lead to vehicle damage.

Symbols

Page references are indicated with ⇨.
⇨ means "see page".

Chronological order to select menu entries in the vehicle personalisation is indicated with ➤.

Page references and index entries refer to the indented headings given in the section table of content.

Thank you for choosing a Vauxhall.

We wish you many hours of pleasurable driving.

Your Vauxhall Team

In brief

Initial drive information

Vehicle unlocking



Press  to lock the vehicle. Open the doors by pulling the handles.

Press  to unlock the tailgate only.

With electronic key system the vehicle is unlocked by passing the hand behind one of the front door handles or by pressing the tailgate button.

Tailgate

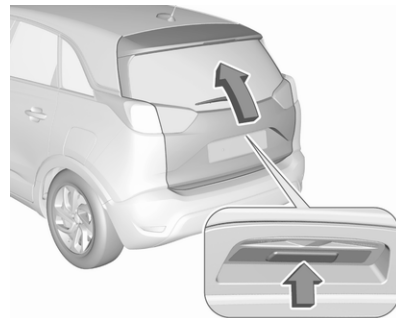

Press tailgate button and open the tailgate.

Radio remote control ⇨ 21.

Central locking system ⇨ 23.

Electronic key system ⇨ 22.

Load compartment ⇨ 29.

Seat adjustment

Longitudinal adjustment



Pull handle, slide seat, release handle. Try to move the seat back and forth to ensure that the seat is locked in place.

Seat position ⇄ 41.

Seat adjustment ⇄ 42.

Backrests inclination



Turn handwheel. Do not lean on backrest when adjusting.

Seat position ⇄ 41.

Seat adjustment ⇄ 42.

Seat height

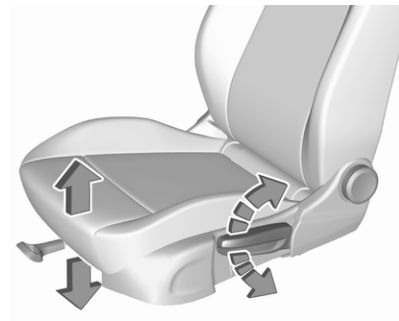

Lever pumping motion

up : seat higher

down : seat lower

Seat position ⇄ 41.

Seat adjustment ⇄ 42.

Seat inclination



Press switch

top : front end higher

bottom : front end lower

Seat position ⇨ 41.

Seat adjustment ⇨ 42.

Head restraint adjustment

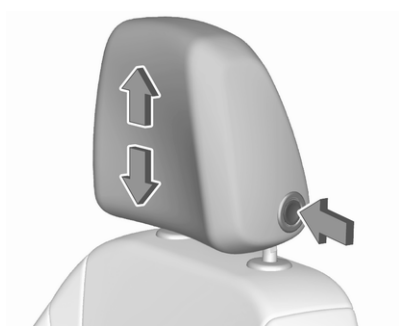

Press release button, adjust height, engage.

Head restraints ⇨ 40.

Seat belt



Pull out the seat belt and fasten in seat belt buckle. The seat belt must not be twisted and must fit close against the body. The backrest must not be tilted back too far (maximum approx. 25°).

To unfasten seat belt, press red button on seat belt buckle.

Seat position ⇨ 41.

Seat belts ⇨ 46.

Airbag system ⇨ 49.

Mirror adjustment

Interior mirror



To adjust the mirror, move the mirror housing in the desired direction.

Manual anti-dazzle interior mirror
↪ 35.

Automatic anti-dazzle interior mirror
↪ 35.

Exterior mirrors

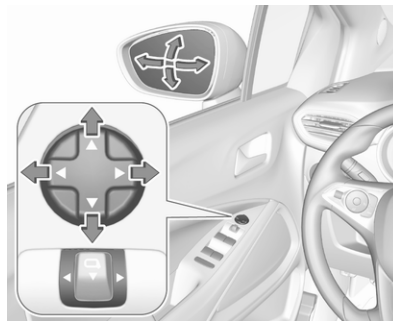

Select the relevant exterior mirror by pushing the mirror button to the left or right. Adjust respective mirror by the four-way control.

Convex mirrors ↪ 33.

Electric adjustment ↪ 33.

Folding mirrors ↪ 34.

Heated mirrors ↪ 34.

Steering wheel adjustment

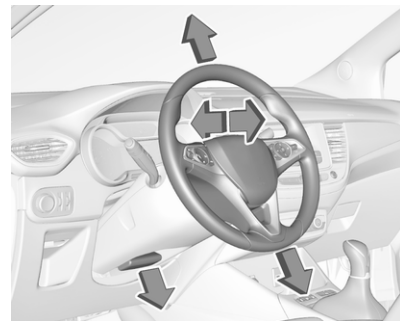

Unlock lever, adjust steering wheel, then engage lever and ensure it is fully locked. Do not adjust steering wheel unless vehicle is stationary and steering wheel lock has been released.

Seat position ↪ 41.

Ignition switch positions ↪ 124.

Power button ↪ 124

Instrument panel overview

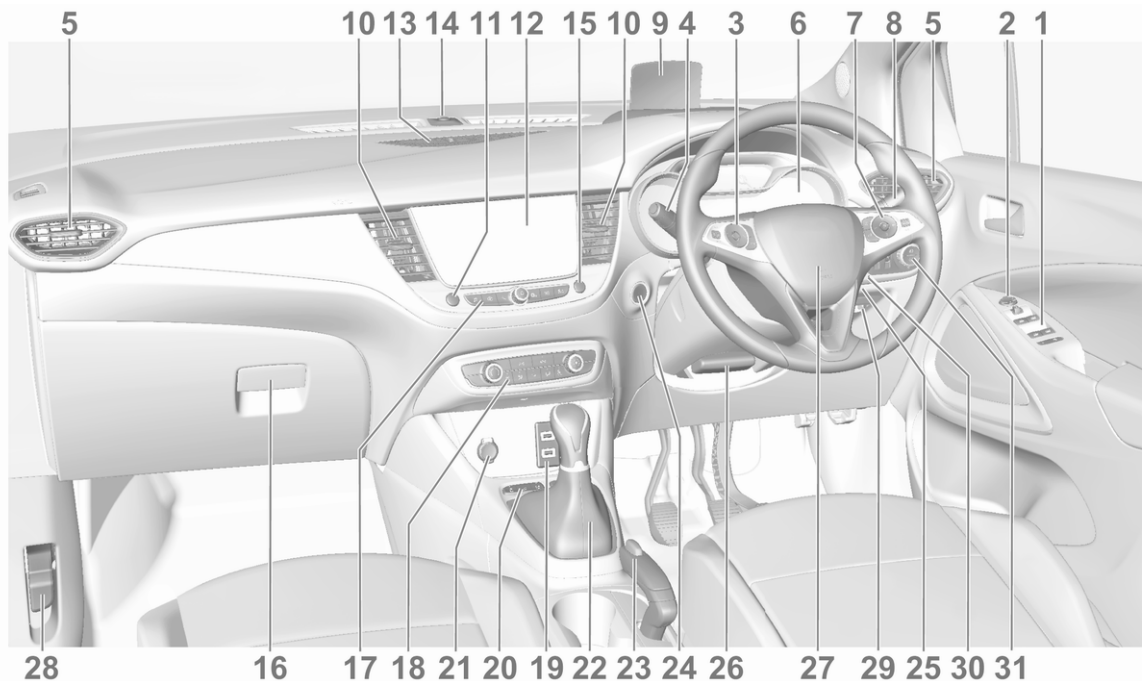

<p>1 Power windows 36</p> <p>2 Exterior mirrors 33</p> <p>3 Cruise control 144</p> <p style="padding-left: 20px;">Speed limiter 147</p> <p style="padding-left: 20px;">Heated steering wheel 70</p> <p>4 Turn lights 106</p> <p style="padding-left: 20px;">Headlight flash 104</p> <p style="padding-left: 20px;">High beam 103</p> <p style="padding-left: 20px;">High beam assist 103</p> <p style="padding-left: 20px;">Exit lighting 109</p> <p style="padding-left: 20px;">Parking lights 107</p> <p style="padding-left: 20px;">Buttons for Driver Information Centre 89</p> <p>5 Side air vents 120</p> <p>6 Instruments 79</p> <p style="padding-left: 20px;">Driver Information Centre 89</p> <p>7 Infotainment controls 70</p> <p>8 Windscreen wiper and washer, rear wiper and washer 71</p> <p>9 Head-up display 93</p> <p>10 Air vents 120</p>	<p>11 Hazard warning flashers 105</p> <p>12 Info Display 92</p> <p>13 Air vent 120</p> <p>14 Light sensor 103</p> <p style="padding-left: 20px;">Rain sensor 71</p> <p style="padding-left: 20px;">Sun sensor 115</p> <p>15 Central locking system 23</p> <p>16 Glovebox 61</p> <p style="padding-left: 20px;">Fuse box 196</p> <p>17 Controls for Info Display operation 92</p> <p>18 Climate control system 111</p> <p>19 USB port 74</p> <p>20 Electronic Stability Control and Traction Control 140</p> <p style="padding-left: 20px;">Lane departure warning 167</p> <p style="padding-left: 20px;">Stop-start system 127</p> <p style="padding-left: 20px;">Parking assist 154</p> <p style="padding-left: 20px;">Advanced parking assist 157</p> <p style="padding-left: 20px;">Electric child locks 28</p> <p>21 Power outlet 74</p> <p>22 Selector lever 134</p> <p>23 Parking brake 139</p>	<p>24 Power button 124</p> <p>25 Ignition switch 124</p> <p>26 Steering wheel adjustment . . 70</p> <p>27 Horn 71</p> <p>28 Bonnet release lever 179</p> <p>29 Storage 61</p> <p style="padding-left: 20px;">Fuse box 196</p> <p>30 Head-up display 93</p> <p>31 Light switch 102</p> <p style="padding-left: 20px;">Headlight range adjustment 104</p> <p style="padding-left: 20px;">Front fog lights 106</p> <p style="padding-left: 20px;">Rear fog light 107</p> <p style="padding-left: 20px;">Instrument illumination 108</p>
--	---	--

Exterior lighting



AUTO : automatic light control
switches automatically
between daytime running
light and headlight

D : sidelights

D : headlights

Automatic light control ⇨ 103.

Front fog lights ⇨ 106.

Rear fog light ⇨ 107.

Headlight flash and high beam

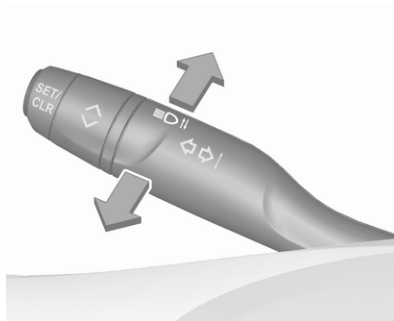

pull : headlight flash
push : high beam

High beam ⇨ 103.

High beam assist ⇨ 103.

Headlight flash ⇨ 104.

LED headlights ⇨ 105.

Turn lights

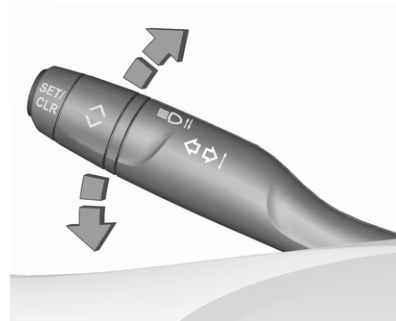



up : right turn light
down : left turn light

Turn lights ⇨ 106.

Parking lights ⇨ 107.

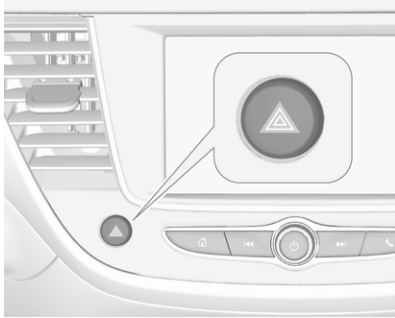
Hazard warning flashers



Operated by pressing .
 Hazard warning flashers ⇨ 105.

Horn



Press .

Washer and wiper systems

Windscreen wiper

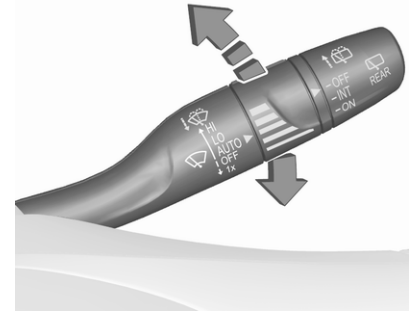

- HI** : fast
- LO** : slow
- INT** : interval wiping
- or
- AUTO** : automatic wiping with rain sensor
- OFF** : off
- 1x** : single wipe

Windscreen wiper ⇨ 71.

Windscreen washer

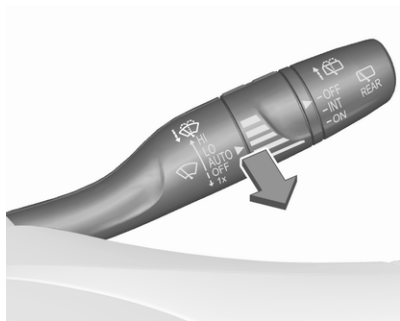

Pull.

Windscreen washer system ↗ 71.

Washer fluid ↗ 181.

Rear window wiper



OFF : off

INT : intermittent operation

ON : continuous operation

Rear window washer

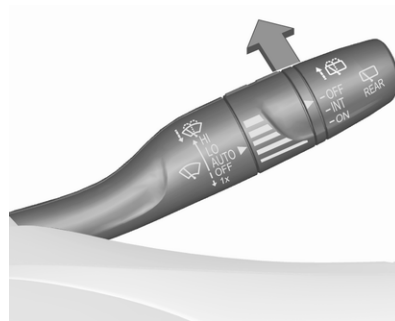

Push.

Washer fluid is sprayed on the rear window and the wiper wipes a few times.

Rear window wiper / washer ↗ 73.

Climate control

Heated rear window

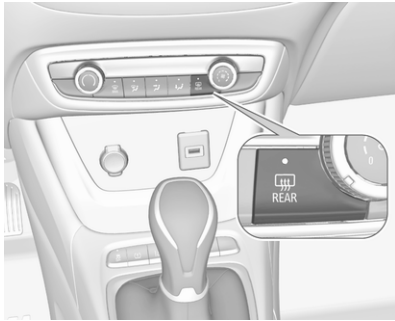

The heating is operated by pressing





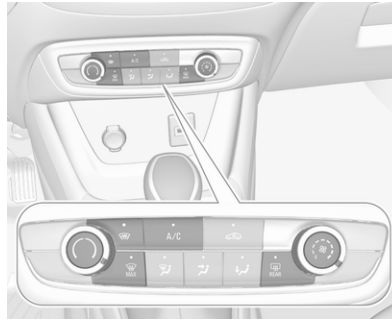

Heated rear window ↗ 37.

Heated exterior mirrors ↗ 34.

Demisting and defrosting the windows



- Press : the air distribution is directed towards the windscreen.
- Set temperature controller  to warmest level.
- Switch on air conditioning **A/C** if required.
- Set fan speed  to highest level.
- Switch on heated rear window .
- Switch on heated windscreen .
- Open side air vents as required and direct them towards the door windows.

Climate control systems ↗ 111.

Heated windscreen ↗ 38.

Transmission

Manual transmission

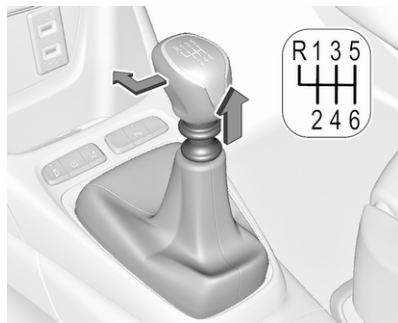

To engage reverse on 6-speed transmission, pull the ring.

Manual transmission ⇨ 137.

Automatic transmission

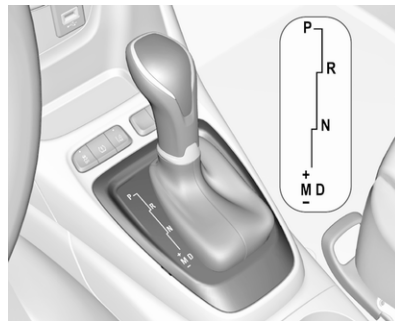

P : park position

R : reverse

N : neutral mode

D : automatic mode

M : manual mode

+ : upshift

- : downshift

Automatic transmission ⇨ 134.

Starting off

Check before starting off

- tyre pressure ⇨ 199 and condition
- engine oil level and fluid levels ⇨ 180
- all windows, mirrors, exterior lighting and number plates are free from dirt, snow and ice and are operational
- proper position of mirrors ⇨ 33, seats ⇨ 41 and seat belts ⇨ 47
- brake function at low speed, particularly if the brakes are wet

Starting the engine

Ignition switch

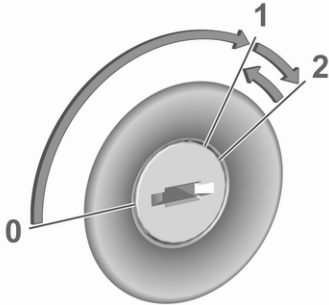

- Turn key to position **1**.
- Move the steering wheel slightly to release the steering wheel lock.
- Manual transmission: operate clutch and brake pedal.
Automatic transmission: operate brake pedal and move selector lever to **P** or **N**.
- Do not operate accelerator pedal.

- Diesel engine: wait until control indicator  for preheating extinguishes.
- Turn key to position **2** and release after engine has been started.

Starting the engine ⇨ 125.

Power button



- Manual transmission: operate clutch and brake pedal.
Automatic transmission: operate brake pedal and move selector lever to **P** or **N**.
- Do not operate accelerator pedal.
- Press **Start/Stop** button.
- Release button after starting procedure begins.

Stop-start system



If the vehicle is at a low speed or at a standstill and certain conditions are fulfilled, an Autostop is activated.

An Autostop is indicated by control indicator (A).

Manual transmission: to restart the engine, depress the clutch pedal again. Control indicator (A) extinguishes.

Automatic transmission: to restart the engine, release the brake pedal. Control indicator (A) extinguishes.

Stop-start system ⇨ 127.

Parking

⚠ Warning

- Do not park the vehicle on an easily ignitable surface. The high temperature of the exhaust system could ignite the surface.
- Always apply the parking brake. Activate the parking brake without pressing the release button. Apply as firmly as possible on a downhill slope or uphill slope. Depress brake pedal at the same time to reduce operating force.
- Switch off the engine.
- If the vehicle is on a level surface or uphill slope, engage first gear or set the selector lever to position **P**. On an uphill slope, turn the front wheels away from the kerb.

If the vehicle is on a downhill slope, engage reverse gear or set the selector lever to position

P. Turn the front wheels towards the kerb.

- Close the windows.
- Remove the ignition key from the ignition switch or switch off ignition on vehicles with power button. Turn the steering wheel until the steering wheel lock is felt to engage.
- Lock the vehicle with  on the radio remote control.
Or with electronic key system press marking on front door handles ⇨ 22.
- Activate the anti-theft alarm system ⇨ 31.
- The engine cooling fans may run after the engine has been switched off ⇨ 179.

Caution

After running at high engine speeds or with high engine loads, operate the engine briefly at a low load or run in neutral for

approx. 30 seconds before switching off, in order to protect the turbocharger.

Keys, locks ⇨ 20.

Laying-up the vehicle for a long period of time ⇨ 178.

Keys, doors and windows

Keys, locks	20
Keys	20
Radio remote control	21
Electronic key system	22
Central locking system	23
Automatic locking	28
Child locks	28
Doors	29
Load compartment	29
Vehicle security	30
Anti-theft locking system	30
Anti-theft alarm system	31
Immobiliser	33
Exterior mirrors	33
Convex shape	33
Electric adjustment	33
Folding mirrors	34
Heated mirrors	34
Interior mirrors	35
Manual anti-dazzle	35
Automatic anti-dazzle	35
Windows	35
Windscreen	35

Manual windows	36
Power windows	36
Heated rear window	37
Heated windscreen	38
Sun visors	38
Roof	38
Glass panel	38

Keys, locks

Keys

Caution
Do not attach heavy or bulky items to the ignition key.

Replacement keys

The key number is specified on a detachable tag.

The key number must be quoted when ordering replacement keys as it is a component of the immobiliser system.

Locks ⇨ 214.

Central locking ⇨ 23.

Starting the engine ⇨ 125.

Radio remote control ⇨ 21.

Electronic key ⇨ 22.

The code number of the adapter for the locking wheel nuts is specified on a card. It must be quoted when ordering a replacement adapter.

Wheel changing ⇨ 206.

Key with foldaway key section



Press button to extend. To fold the key, first press the button.

Lock cylinders

Designed to free-wheel if they are forcefully rotated without the correct key or if the correct key is not fully inserted. To reset, turn cylinder with the correct key until its slot is vertical, remove key then re-insert it. If the cylinder still free-wheels, turn the key through 180° and repeat operation.

Radio remote control



Enables operation of the following functions via the use of the remote control buttons:

- central locking system ⇨ 23
- anti-theft locking system ⇨ 30
- anti-theft alarm system ⇨ 31
- tailgate unlocking ⇨ 23
- power windows ⇨ 36
- mirrors folding ⇨ 34

The remote control has a range of up to 100 m, but may also be much less due to external influences. The hazard warning flashers confirm operation.

Handle with care, protect from moisture and high temperatures and avoid unnecessary operation.

Replacing battery in radio remote control

Replace the battery as soon as the range reduces.



Batteries do not belong in household waste. They must be disposed of at an appropriate recycling collection point.

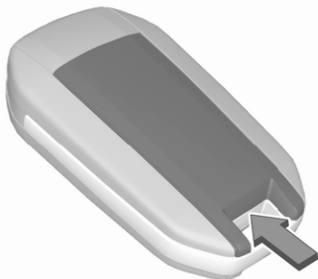

1. To unclip the cover insert a small screwdriver between the back cover and the remote control.
2. Remove the back cover.
3. Extract the flat battery from its location.
4. Replace battery with a battery of the same type. Pay attention to the installation position.
5. Clip the cover in place.

Fault

If the central locking system cannot be operated with the radio remote control, the cause may be one of the following:

- Fault in radio remote control.
- The range is exceeded.
- The battery voltage is too low.
- Frequent, repeated operation of the radio remote control while not in range.
- Overload of the central locking system by operating at frequent intervals, the power supply is interrupted for a short time.
- Interference from higher-power radio waves from other sources.

Manual unlocking ⇨ 23.

Electronic key system



Enables a keyless operation of the following functions:

- central locking system ⇨ 23
- ignition switching on and starting the engine ⇨ 125

The electronic key simply needs to be on the driver's person.

Additionally, the electronic key includes the functionality of the radio remote control ⇨ 21.

Handle with care, protect from moisture and high temperatures and avoid unnecessary operation.

Notice

To save battery power, the keyless functions are set to stand-by after 21 days of non-use. To reactivate the functions, press a button on the electronic key.

Replacing battery in electronic key

Replace the battery as soon as the system no longer operates properly or the range is reduced. The need for battery replacement is indicated by a message in the Driver Information Centre ⇨ 95.



Batteries do not belong in household waste. They must be disposed of at an appropriate recycling collection point.



1. To unclip the cover insert a small screwdriver in the cutout.
2. Remove the cover.
3. Extract the flat battery from its location.
4. Replace battery with a battery of the same type. Pay attention to the installation position.
5. Clip the cover in place.

Fault

If the central locking cannot be operated or the engine cannot be started, the cause may be one of the following:

- Fault in electronic key.
- Electronic key is out of reception range.
- The battery voltage is too low.
- Overload of the central locking system by operating at frequent intervals, the power supply is interrupted for a short time.
- Interference from higher-power radio waves from other sources.

To rectify the cause of the fault, change the position of the electronic key.

Manual unlocking ⇨ 23.

Central locking system

Unlocks and locks doors, load compartment and fuel filler flap.

Pull an interior door handle fully to unlock and open the respective door.

Notice

In the event of an accident in which airbags or belt pretensioners are deployed, the vehicle is automatically unlocked.

Automatic locking ⇨ 28

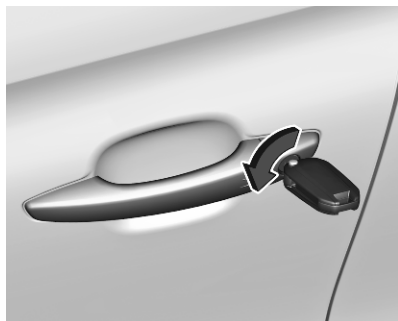
Rigid key**Unlocking**

Turn key in the driver's door lock cylinder.

Unlocking mode can be set in the vehicle personalisation menu in the Info Display. Two settings are selectable:

- All doors, load compartment and fuel filler flap will be unlocked by turning the key once.
- Only the driver's door and fuel filler flap will be unlocked by turning the key once. To unlock entire vehicle, turn the key twice.

Vehicle personalisation ⇨ 96.

Locking

Close doors, load compartment and fuel filler flap.

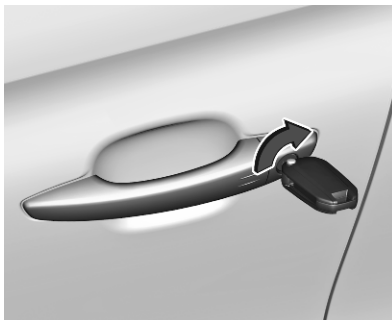



Turn key in the driver's door lock cylinder.

If the vehicle is not closed properly, the central locking system will not work.

Remote control operation**Unlocking**

Press Ⓛ.

Unlocking mode can be set in the vehicle personalisation menu in the Info Display. Two settings are selectable:

- All doors, load compartment and fuel filler flap will be unlocked by pressing  once.
- Only the driver's door and fuel filler flap will be unlocked by pressing  once. To unlock entire vehicle, press  twice.

Vehicle personalisation ⇨ 96.

Unlocking the tailgate

Press  longer to unlock the tailgate only.

Vehicle personalisation ⇨ 96.

Unlocking and opening the tailgate ⇨ 29.

Locking

Close doors, load compartment and fuel filler flap.



Press .

If the vehicle is not closed properly, the central locking system will not work.

Confirmation

Operation of the central locking system is confirmed by the hazard warning flashers.

Electronic key system operation

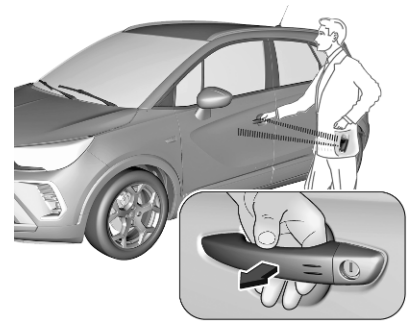

The electronic key must be outside the vehicle, within a range of approx. 1 m of the relevant door side.

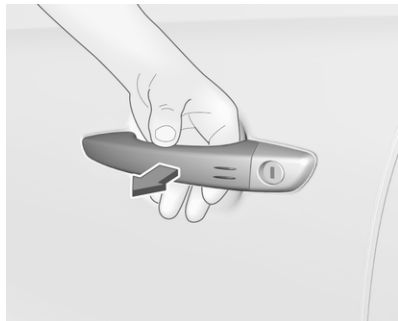
Unlocking

Pass hand behind one of the front door handles to unlock the vehicle or press the tailgate button.

Unlocking mode can be set in the vehicle personalisation. Three settings are selectable:

- Only the driver's door and fuel filler flap will be unlocked by passing hand behind the driver's door handle.

- Entire vehicle will be unlocked by passing hand behind one of the front door handles or by pressing the tailgate button.
- Only the tailgate will be unlocked by pressing the tailgate button.

Vehicle personalisation ⇨ 96

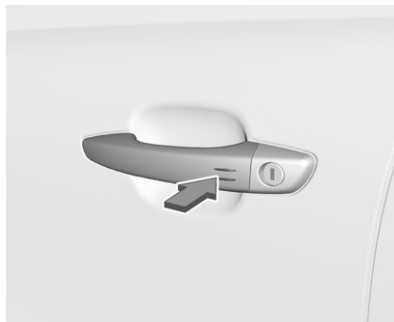
Locking

Press marking of the front door handles.

Entire vehicle will be locked.

If the vehicle is not closed properly, the electronic key remains in the vehicle or the ignition is not off, locking will not be permitted and a warning chime sounds.

Unlocking and opening the tailgate

The tailgate can be unlocked and opened by pushing the tailgate button when the electronic key is in range. The doors remain locked depending on the configuration in the vehicle personalisation.

Load compartment ⇨ 29

Vehicle personalisation ⇨ 96

Confirmation

Operation of central locking system is confirmed by the hazard warning flashers.

Central locking button

Locks or unlocks entire vehicle from the passenger compartment via a switch.



Press  to lock. The LED in the button illuminates.

Press  again to unlock. The LED in the button extinguishes.

Operation with the key in case of a central locking system fault

In case of a fault, e.g. vehicle battery or remote control / electronic key battery is discharged, the vehicle can be locked or unlocked with the mechanical key.

Manual unlocking

Electronic key: press and hold the latch to extract the integral key.

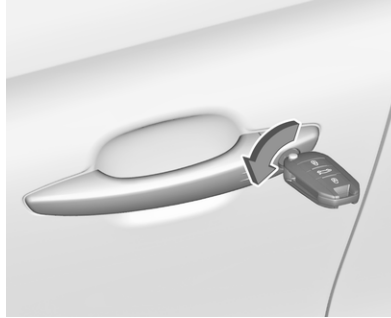

Manually unlock the driver's door by inserting and turning the key in the lock cylinder. With working central locking system the vehicle will be unlocked.

By switching on the ignition, the anti-theft locking system is deactivated.

The other doors can be opened by pulling the interior handle. The load compartment and fuel filler flap will possibly not be unlocked.

Manual locking

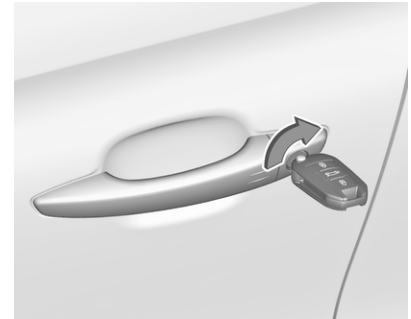

Manually lock the driver's door by inserting and turning the key in the lock cylinder. With working central locking system the vehicle will be locked.

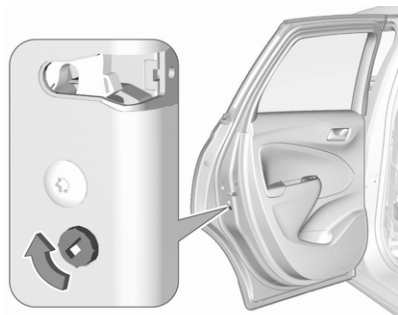

To lock the other doors, first remove the black cover by inserting a key and turning clockwise.

Insert key into the recess and move latch sideways.

Remove key and attach the black cover.

The fuel filler flap and tailgate are possibly not locked.

Automatic locking

Automatic locking after driving off

This system allows automatic locking as soon as the speed of the vehicle exceeds 6 mph.

If the vehicle is not closed properly, the automatic locking does not take place. This is signalled by the sound of the locks rebounding, accompanied by illumination of  in the instrument panel, an audible signal and the display of an alert message.

Activation or deactivation



With the ignition on, press  until an audible signal starts and a corresponding message is displayed. The state of the system stays in memory when switching off the ignition.

Automatic relock after unlocking

This feature automatically relocks the vehicle a short time after unlocking with the remote control or electronic key, provided vehicle has not been opened.

Child locks

Warning

Use the child locks whenever children are occupying the rear seats.

Mechanical child locks



Turn the red child lock in the rear doors to the horizontal position by using a key. The door cannot be opened from the inside.

To deactivate, turn the child lock to the vertical position.

Electric child locks

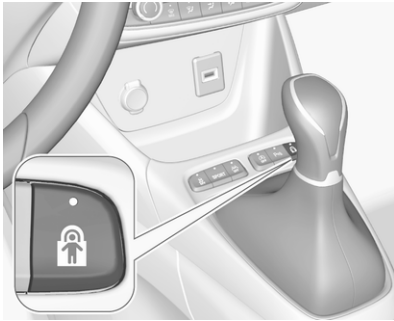

Remotely operated system to prevent opening of the rear doors using the interior handles.

Switching on

Press . The indicator light in the button comes on, accompanied by a confirmation message. This indicator light remains on until the child lock is switched off.

Switching off

Press  again. The indicator light in the button goes off, accompanied by a confirmation message.

Doors

Load compartment

Tailgate

Opening

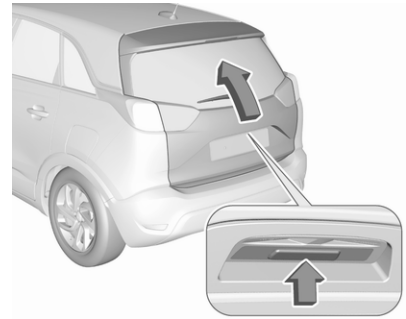

Press the tailgate button and open the tailgate.

Closing



Use the interior handle.

Do not push the tailgate button whilst closing as this will open the tailgate again.

Central locking system ⇨ 23.

General hints for operating tailgate

⚠ Danger

Do not drive with the tailgate open or ajar, e.g. when transporting bulky objects, since toxic exhaust

gases, which cannot be seen or smelled, could enter the vehicle. This can cause unconsciousness and even death.

Caution

Before opening the tailgate, check overhead obstructions, e.g. a garage door, to avoid damage to the tailgate. Always check the moving area above and behind the tailgate.

Notice

The installation of certain heavy accessories onto the tailgate may affect its ability to remain open.

Notice

At low outside temperatures the tailgate may not open fully by itself. In this event, lift the tailgate manually to its normal end position.

Vehicle security

Anti-theft locking system

⚠ Warning

Do not use the system if there are people in the vehicle! The doors cannot be unlocked from the inside.

The system deadlocks all the doors. All doors must be closed otherwise the system cannot be activated.

Unlocking the vehicle disables the mechanical anti-theft locking system. This is not possible with the central locking button.

Activating



Press  on the radio remote control twice within 5 seconds.

Or with electronic key system press twice the marking on one of the front door handles.

Anti-theft alarm system

The anti-theft alarm system is combined with the central locking system.

It monitors:

- doors, tailgate, bonnet
- passenger compartment including adjoining load compartment
- vehicle inclination, e.g. if it is raised
- ignition

Activation

All doors must be closed.

The electronic key of the electronic key system must not remain in the vehicle.

- Radio remote control: activated 30 seconds after locking the vehicle by pressing  once.
- Electronic key system: activated 30 seconds after locking the vehicle by pressing marking on one of the front door handles.



- Radio remote control: directly by pressing  twice within 5 seconds.
- Electronic key system: directly by pressing twice the marking on one of the front door handles.



Notice

Changes to the vehicle interior such as the use of seat covers and open windows, could impair the function of passenger compartment monitoring.

Activation without monitoring of passenger compartment and vehicle inclination



Switch off the monitoring of passenger compartment and vehicle inclination when animals are being left in the vehicle, because of high volume ultrasonic signals and because movements could trigger the alarm. Also switch off when the vehicle is on a ferry or train.

1. Close tailgate, bonnet, windows.
2. Press . LED in the button  illuminates for a maximum of 10 minutes.

3. Close doors.
4. Activate the anti-theft alarm system.

Indication

LED in the  button flashes if the anti-theft alarm system is activated.

Seek the assistance of a workshop in the event of faults.

Deactivation

Radio remote control: Unlocking the vehicle by pressing  deactivates the anti-theft alarm system.



Electronic key system: Unlocking the vehicle by pressing marking on one of the front door handles deactivates the anti-theft alarm system.

The electronic key must be outside the vehicle, within a range of approx. 1 m of the relevant door side.

The system is not deactivated by unlocking the driver's door with the key or with the central locking button in the passenger compartment.

Alarm

When triggered, the alarm siren sounds and the hazard warning lights flash simultaneously. The number and duration of alarm signals are stipulated by legislation.

The anti-theft alarm system can be deactivated by pressing  or switching on the ignition.

Electronic key system: The anti-theft alarm system can be deactivated by pressing marking on one of the front door handles.

A triggered alarm, which has not been interrupted by the driver, will be indicated by the hazard warning

lights. They will flash quickly four times the next time the vehicle is unlocked with the radio remote control.

If the vehicle's battery is to be disconnected (e.g. for maintenance work), the alarm siren must be deactivated as follows: switch the ignition on then off, then disconnect the vehicle's battery within 15 seconds.

If the battery has been reconnected (e.g. after maintenance work), wait for 10 minutes to restart the engine.

Immobiliser

The system checks whether the vehicle is allowed to be started with the key being used.

The immobiliser is activated automatically at the end of a trip.

Notice

Radio Frequency Identification (RFID) tags may cause interference with the key. Do not have it placed near the key when starting the vehicle.

Notice

The immobiliser does not lock the doors. Always lock the vehicle after leaving it ⇨ 23.

Switch on the anti-theft alarm system ⇨ 31.

Emergency operation of electronic key ⇨ 124.

Exterior mirrors

Convex shape

The shape of the mirror makes objects appear smaller, which will affect the ability to estimate distances.

Electric adjustment

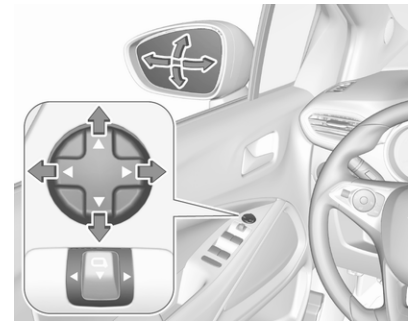

Select the relevant exterior mirror by pushing the mirror button to the left or right.

Then swivel the control to adjust the mirror.

Folding mirrors

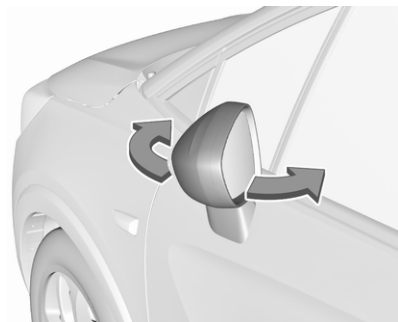

For pedestrian safety, the exterior mirrors will swing out of their normal mounting position if they are struck with sufficient force. Reposition the mirror by applying slight pressure to the mirror housing.

Electric folding

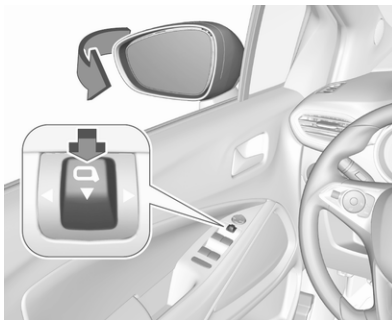

Pull mirror button rearwards. Both exterior mirrors will fold.

Pull mirror button rearwards again to return both exterior mirrors to their original position.

If an electrically folded mirror is manually extended, pulling mirror button rearwards will only electrically extend the other mirror.

Automatic folding

When the vehicle is unlocked, the mirrors swing to their normal mounting position. When the vehicle is locked, the mirrors are folded down.

To enable or disable automatic folding of the exterior mirrors, consult a workshop.

Heated mirrors



Operated by pressing  REAR.

Heating works with the engine running and is switched off automatically after a short time.

Heated rear window  37.

Interior mirrors

Manual anti-dazzle



To reduce dazzle, adjust the lever on the underside of the mirror housing.

Automatic anti-dazzle



Dazzle from following vehicles is automatically reduced, when driving in the dark.

Windows

Windscreen

Windscreen stickers



Do not attach stickers such as toll road stickers or similar on the windscreen in the area of the interior mirror. Keep the sensor free from dust, dirt and ice. Otherwise the detection zone of the rain sensor / light sensor and the view area of the camera in the mirror housing could be restricted.

Sensors ⇨ 71, ⇨ 103

Windscreen replacement

Caution

If the vehicle has a front-looking camera sensor for the driver assistance systems, it is very important that any windscreen replacement is performed accurately according to Vauxhall specifications. Otherwise, these systems may not work properly and there is a risk of unexpected behaviour and / or messages from these systems.

Manual windows

The rear door windows can be opened or closed manually with the window cranks.

Power windows

⚠ Warning

Take care when operating the power windows. Risk of injury, particularly to children.

If there are children on the rear seats, switch on the child safety system for the power windows.

Keep a close watch on the windows when closing them. Ensure that nothing becomes trapped in them as they move.

Switch on ignition to operate power windows.

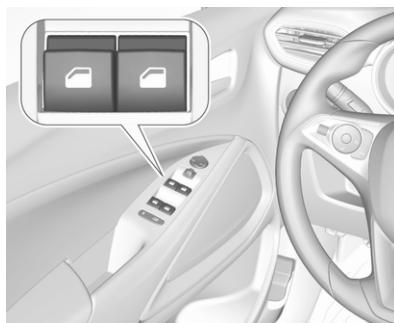

Operate the switch for the respective window by pushing to open or pulling to close.

Pushing or pulling gently to the first detent: window moves up or down as long as the switch is operated.

Pushing or pulling firmly to the second detent then releasing: window moves up or down automatically with safety function enabled. To stop movement, operate the switch once more in the same direction.

Safety function



If the window glass encounters resistance above the middle of the window during automatic closing, it is immediately stopped and opened again.

Override safety function

In the event of closing difficulties due to frost or the like, switch on the ignition, then pull the switch to the first detent and hold. The window moves up without safety function enabled. To stop movement, release the switch.

Child safety system for rear windows



Press  to deactivate rear door power windows; the LED illuminates. To activate, press  again.

Operating windows from outside

The windows can be operated remotely from outside the vehicle.

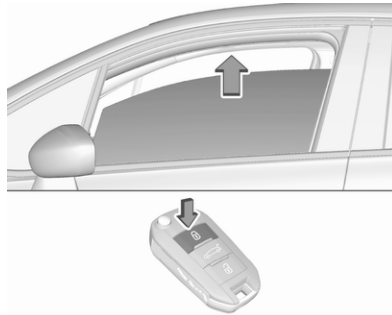

Press and hold  to close windows. Release button to stop window movement.

If the windows are fully closed, the hazard warning lights will flash twice.

Overload

If the windows are repeatedly operated within short intervals, the window operation is disabled for some time.

Initialising the power windows

If the windows cannot be closed automatically (e.g. after disconnecting the vehicle battery), a warning message is displayed in the Driver Information Centre.

Vehicle messages ⇨ 95.

Activate the window electronics as follows:

1. Close doors.
2. Switch on ignition.
3. Pull switch until the window is closed and keep pulling for additional 2 seconds.
4. Push switch until the window is completely open and keep pushing for additional 2 seconds.
5. Repeat for each window.

Heated rear window

Operated by pressing .

Heating works with the engine running and is switched off automatically after a short time.

Depending on climate control system,  is located at a different position.



Heated exterior mirrors ⇨ 34.

Heated windscreen

Operated by pressing . LED in button illuminates.

Heating works with the engine running and is switched off automatically after a short time.

Depending on climate control system, is located at a different position.



Sun visors

The sun visors can be folded down or swivelled to the side to prevent dazzling.

The covers of the mirrors should be closed when driving.

A ticket holder is located on the backside of the sun visor.

Roof

Glass panel

Sunblind

The sunblind is electrically operated.



Press gently to the first detent at the rear: the sunblind is opened as long as the switch is operated.

Press firmly to the second detent and then release at the rear: the sunblind is completely opened.

Press gently to the first detent at the front: the sunblind is closed as long as the switch is operated.



Press  firmly to the second detent and then release at the front: the sunblind is completely closed.

Safety function



If the sunblind encounters resistance during automatic closing, it is immediately stopped and opened again.

Initialising after a power failure

After a power failure, it may only be possible to operate the sunblind to a limited extent. Initialise the system as follows:

1. Switch on ignition.
2. Press  twice gently to the first detent at the rear, the sunblind opens slightly.
3. Immediately press  twice gently to the first detent at the front, the sunblind closes slightly.

After step 3 the sunblind is in initialising mode without safety function.

4. Press  gently to the first detent at the rear until the sunblind is completely opened.
5. Press  gently to the first detent at the front until the sunblind is completely closed.

After this procedure, the sunblind is initialised with safety function activated.

When  is pressed firmly to the second detent during initialising, the procedure is cancelled.

Seats, restraints

Head restraints	40
Front seats	41
Seat position	41
Seat adjustment	42
Armrest	44
Heating	44
Rear seats	45
Armrest	45
Seat belts	46
Three-point seat belt	47
Airbag system	49
Front airbag system	52
Side airbag system	52
Curtain airbag system	53
Airbag deactivation	54
Child restraints	55
Child restraint systems	55
Child restraint installation locations	58

Head restraints

Position

⚠ Warning

Only drive with the head restraint set to the proper position.

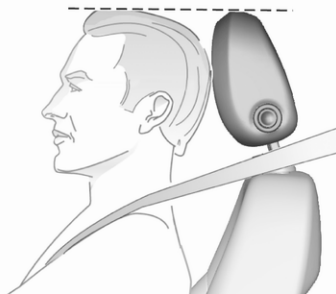

The upper edge of the head restraint should be at upper head level. If this is not possible for extremely tall people, set to highest position, and set to lowest position for small people.

Head restraints on front seats

Height adjustment

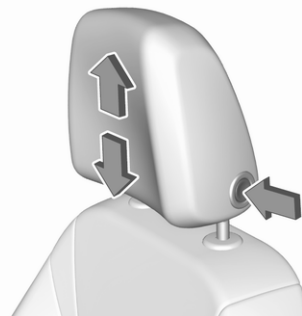

Press release button, adjust height, engage.

Head restraints on rear seats

Height adjustment

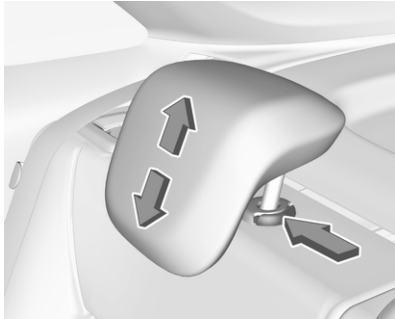

Pull the head restraint upwards or press the catch to release and push the head restraint downwards.

Removal of rear head restraint

E.g. when using a child restraint system ⇨ 55.

Pull the head restraint upwards, press the catch to release and pull the head restraint out.

Front seats

Seat position

⚠ Warning

Only drive with the seat correctly adjusted.

⚠ Danger

Do not sit closer than 25 cm to the steering wheel, to permit safe airbag deployment.

⚠ Warning

Never adjust seats while driving as they could move uncontrollably.

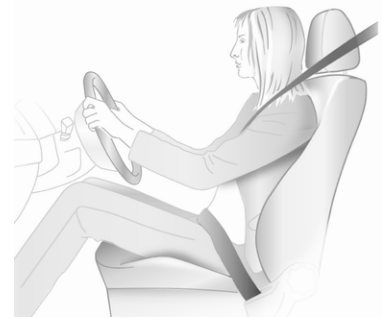

- Sit with buttocks as far back against the backrest as possible. Adjust the distance between the seat and the pedals so that legs are slightly angled when fully pressing the pedals. Slide the front passenger seat as far back as possible.
- Set seat height high enough to have a clear field of vision on all sides and on instrument cluster. There should be at least one hand of clearance between head and the roof frame. Thighs should rest lightly on the seat without pressing into it.

- Sit with shoulders as far back against the backrest as possible. Set the backrest rake so that it is possible to easily reach the steering wheel with arms slightly bent. Maintain contact between shoulders and the backrest when turning the steering wheel. Do not angle the backrest too far back. We recommend a maximum rake of approx. 25°.
- Adjust seat and steering wheel in a way that the wrist rests on top of the steering wheel while the arm is fully extended and shoulders on the backrest.
- Adjust the steering wheel ⇄ 70.
- Adjust the head restraint ⇄ 40.
- Adjust the thigh support so that there is a space approx. two fingers wide between the edge of the seat and the hollow of the knee.
- Adjust the lumbar support so that it supports the natural shape of the spine.

Seat adjustment

Drive only with engaged seats and backrests.

Longitudinal adjustment



Pull handle, slide seat, release handle. Try to move the seat back and forth to ensure that the seat is locked in place.

Backrest inclination

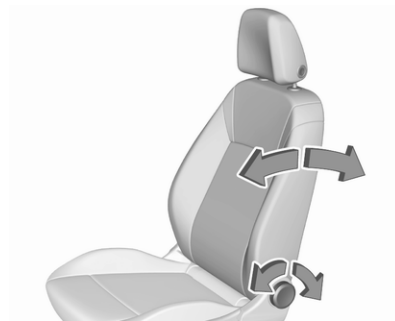

Turn handwheel. Do not lean on backrest when adjusting.

Seat height

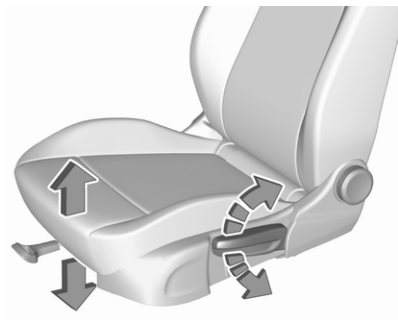

Lever pumping motion

up : seat higher
down : seat lower

Seat inclination



Press switch

top : front end higher
bottom : front end lower

Lumbar support

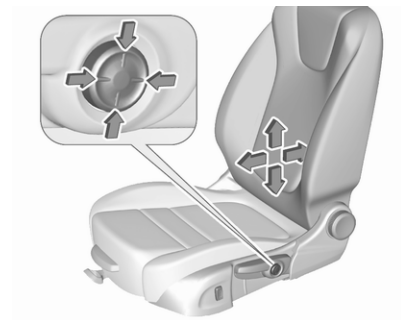

Adjust lumbar support using the four-way switch to suit personal requirements.

Moving support up and down: push switch up or down.

Increasing and decreasing support: push switch forwards or backwards.

Adjustable thigh support

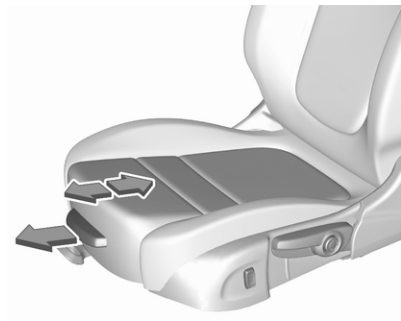

Pull the lever and slide the thigh support.

Armrest



Armrest can be folded up.

Heating



Adjust heating to the desired setting by pressing  for the respective seat one or more times. The control indicator in the button indicates the setting.

Prolonged use of the highest setting for people with sensitive skin is not recommended.

Seat heating is operational when engine is running.

During an Autostop, seat heating is also operational.

Stop-start system ↪ 127.

Rear seats

Drive only with engaged seats and backrests.

⚠ Warning

Never adjust seats while driving as they could move uncontrollably.

Folding backrests ⇨ 62.

Longitudinal adjustment

Both parts of the rear seat can be individually moved forwards or backwards.

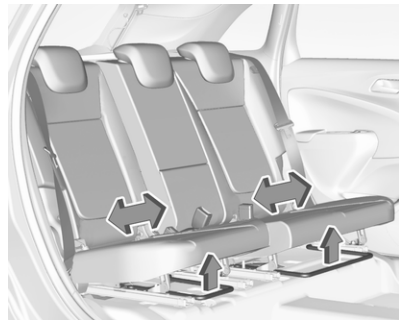

Pull handle, slide seat, release handle. Try to move the seat back and forth to ensure that the seat is locked in place.

Backrest inclination



Pull the loop, adjust inclination and release loop. Do not lean on backrest when adjusting.

Armrest

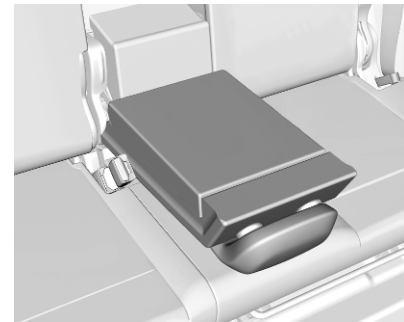

Folding down armrest ⇨ 62.

Seat belts



The seat belts are locked during heavy acceleration or deceleration of the vehicle, holding the occupants in the seat position. Therefore the risk of injury is considerably reduced.

⚠ Warning

Fasten seat belt before each trip.

In the event of an accident, people not wearing seat belts endanger their fellow occupants and themselves.

Seat belts are designed to be used by only one person at a time.

Child restraint system ⇨ 55.

Periodically check all parts of the seat belt system for damage, soiling and proper functionality.

Have damaged components replaced. After an accident, have the seat belts and triggered seat belt pretensioners replaced by a workshop.

Notice

Make sure that the seat belts are neither damaged by shoes or sharp-edged objects nor trapped. Prevent dirt from getting into the seat belt retractors.

Notice

Use the belt buckle intended for the respective seat belt when fastening in order to ensure proper functionality.

Seat belt reminder

Each seat is equipped with a seat belt reminder, indicated by a control indicator  for the respective seat in the roof console ⇨ 83.

Seat belt force limiters

Stress on the body is reduced by the gradual release of the seat belt during a collision.

Seat belt pretensioners

In the event of a head-on, rear-end or side-on collision of a certain severity, the front seat belts and the outer rear seat belts are tightened by seat belt pretensioners.

⚠ Warning

Incorrect handling (e.g. removal or fitting of seat belts) can trigger the seat belt pretensioners.

Deployment of the seat belt pretensioners is indicated by continuous illumination of control indicator  ⇨ 83.

Triggered seat belt pretensioners must be replaced by a workshop. Seat belt pretensioners can only be triggered once.

Notice

Do not affix or install accessories or other objects that may interfere with the operation of the seat belt pretensioners. Do not make any modifications to seat belt pretensioner components as this will invalidate the vehicle operating permit.

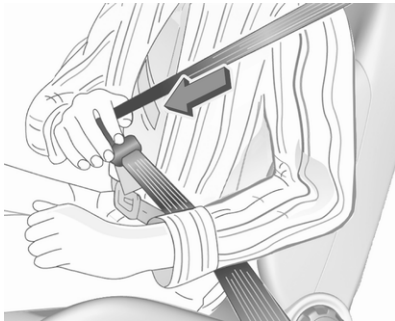
Three-point seat belt**Fasten**

Withdraw the seat belt from the retractor, guide it untwisted across the body and insert the latch plate into the buckle. Make sure the belt fits tightly to the body while driving.

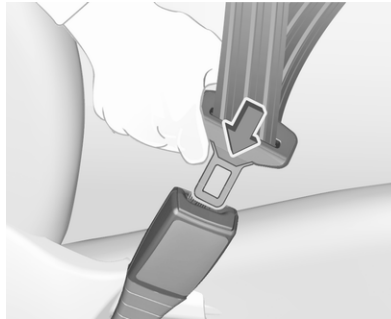

Loose or bulky clothing prevents the seat belt from fitting snugly. Do not place objects such as handbags or mobile phones between the seat belt and your body.

⚠ Warning

The seat belt must not rest against hard or fragile objects in the pockets of your clothing.

Seat belt reminder   83.

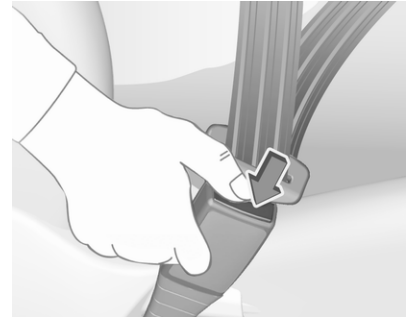
Unfasten

To release seat belt, press red button on seat belt buckle.

Centre seat belt of the second seat row

The centre seat is equipped with a particular three-point seat belt.

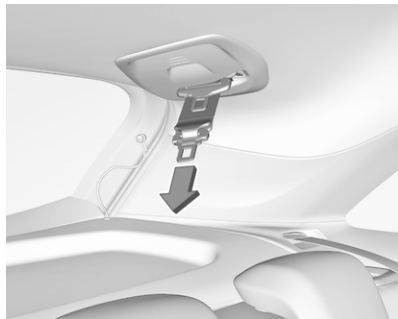

Pull latch plates with the seat belt out of seat belt holder in the roof.

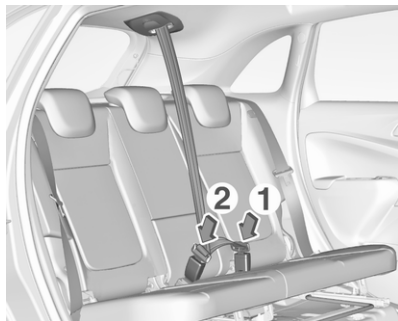

Insert lower latch plate into left-hand buckle (1) at the centre seat. Guide the upper latch plate with the seat belt over the lap area and the shoulder (do not twist) and insert it into right-hand buckle (2) at centre seat.

To unfasten the seat belt, first press the button on the right-hand buckle (2) and remove upper latch plate. Then press the button on the left-hand buckle (1) and remove lower latch plate. The seat belt retracts automatically.

Using the seat belt while pregnant



Warning

The lap seat belt must be positioned as low as possible across the pelvis to prevent pressure on the abdomen.

Airbag system

The airbag system consists of a number of individual systems depending on the scope of equipment.

When triggered, the airbags inflate within milliseconds. They also deflate so quickly that it is often unnoticeable during the collision.

⚠ Warning

The airbag system deploys in an explosive manner, repairs must be performed by skilled personnel only.

⚠ Warning

Adding accessories that change the vehicle's frame, bumper system, height, front end or side sheet metal, may keep the airbag system from working properly. The operation of the airbag system can also be affected by changing any parts of the front seats, seat belts,

airbag sensing and diagnostic module, steering wheel, instrument panel, inner door seals including the speakers, any of the airbag modules, ceiling or pillar trim, front sensors, side impact sensors or airbag wiring.

Notice

The airbag systems and belt pretensioner control electronics are located in the centre console. Do not put any magnetic objects in this area.

Do not affix any objects onto the airbag covers and do not cover them with other materials. Have damaged covers replaced by a workshop.

Each airbag is triggered only once. Have deployed airbags replaced by a workshop. Furthermore, it may be necessary to have the steering wheel, the instrument panel, parts of the panelling, the door seals, handles and the seats replaced.

Do not make any modifications to the airbag system as this will invalidate the vehicle operating permit.

Control indicator  for airbag systems
 ⇨ 83.

Child restraint systems on front passenger seat with airbag systems

Warning according to ECE R94.02:



EN: NEVER use a rearward-facing child restraint on a seat protected by an ACTIVE AIRBAG in front of it; DEATH or SERIOUS INJURY to the CHILD can occur.

DE: Nach hinten gerichtete Kindersitze NIEMALS auf einem Sitz verwenden, der durch einen davor befindlichen AKTIVEN AIRBAG

geschützt ist, da dies den TOD oder SCHWERE VERLETZUNGEN DES KINDES zur Folge haben kann.

FR: NE JAMAIS utiliser un siège d'enfant orienté vers l'arrière sur un siège protégé par un COUSSIN GONFLABLE ACTIF placé devant lui, sous peine d'infliger des BLESSURES GRAVES, voire MORTELLES à l'ENFANT.

ES: NUNCA utilice un sistema de retención infantil orientado hacia atrás en un asiento protegido por un AIRBAG FRONTAL ACTIVO. Peligro de MUERTE o LESIONES GRAVES para el NIÑO.

RU: ЗАПРЕЩАЕТСЯ устанавливать детское удерживающее устройство лицом назад на сиденье автомобиля, оборудованном фронтальной подушкой безопасности, если ПОДУШКА НЕ ОТКЛЮЧЕНА! Это может привести к СМЕРТИ или СЕРЬЕЗНЫМ ТРАВМАМ РЕБЕНКА.

NL: Gebruik NOOIT een achterwaarts gericht kinderzitje op een stoel met een ACTIEVE AIRBAG ervoor, om DODELIJK of ERNSTIG LETSEL van het KIND te voorkomen.

DA: Brug ALDRIG en bagudvendt autostol på et forsæde med AKTIV AIRBAG, BARNET kan komme i LIVSFARE eller komme ALVORLIGT TIL SKADE.

SV: Använd ALDRIG en bakåtvänd barnstol på ett säte som skyddas med en framförvarande AKTIV AIRBAG. DÖDSFALL eller ALLVARLIGA SKADOR kan drabba BARNET.

FI: ÄLÄ KOSKAAN sijoita taaksepäin suunnattua lasten turvaistuinta istuimelle, jonka edessä on AKTIIVINEN TURVATYYNY, LAPSI VOI KUOLLA tai VAMMAUTUA VAKAVASTI.

NO: Bakovervendt barnesikringsutstyr må ALDRI brukes på et sete med AKTIV KOLLISJONSPUTE foran, da det kan føre til at BARNET utsettes for LIVSFARE og fare for ALVORLIGE SKADER.

PT: NUNCA use um sistema de retenção para crianças voltado para trás num banco protegido com um AIRBAG ACTIVO na frente do mesmo, poderá ocorrer a PERDA DE VIDA ou FERIMENTOS GRAVES na CRIANÇA.

IT: Non usare mai un sistema di sicurezza per bambini rivolto all'indietro su un sedile protetto da AIRBAG ATTIVO di fronte ad esso: pericolo di MORTE o LESIONI GRAVI per il BAMBINO!

EL: ΠΟΤΕ μη χρησιμοποιείτε παιδικό κάθισμα ασφαλείας με φορά προς τα πίσω σε κάθισμα που προστατεύεται από μετωπικό ΕΝΕΡΓΟ ΑΕΡΟΣΑΚΟ, διότι το παιδί μπορεί να υποστεί ΘΑΝΑΣΙΜΟ ή ΣΟΒΑΡΟ ΤΡΑΥΜΑΤΙΣΜΟ.

PL: NIE WOLNO montować fotelika dziecięcego zwróconego tyłem do kierunku jazdy na fotelu, przed którym znajduje się WŁĄCZONA PODUSZKA POWIETRZNA. Niezastosowanie się do tego zalecenia może być przyczyną ŚMIERCI lub POWAŻNYCH OBRAŻEŃ u DZIECKA.

TR: Arkaya bakan bir çocuk emniyet sistemini KESİNLİKLE önünde bir AKTİF HAVA YASTIĞI ile korunmakta olan bir koltukta kullanmayınız. ÇOCUK ÖLEBİLİR veya AĞIR ŞEKİLDE YARALANABİLİR.

UK: НИКОЛИ не використовуйте систему безпеки для дітей, що встановлюється обличчям назад, на сидінні з УВІМКНЕНОЮ ПОДУШКОЮ БЕЗПЕКИ, інакше це може призвести до СМЕРТІ чи СЕРІОЗНОГО ТРАВМУВАННЯ ДИТИНИ.

HU: SOHA ne használjon hátrafelé néző biztonsági gyerekléssel előlről AKTÍV LÉGZSÁKKAL védett ülésen, mert a GYERMEK HALÁLÁT vagy KOMOLY SÉRÜLÉSÉT okozhatja.

HR: NIKADA nemojte koristiti sustav zadržavanja za djecu okrenut prema natrag na sjedalu s AKTIVNIM ZRAČNIM JASTUKOM ispred njega, to bi moglo dovesti do SMRTI ili OZBILJNIH OZLJEDA za DIJETE.

SL: NIKOLI ne nameščajte otroškega varnostnega sedeža, obrnjenega v nasprotni smeri vožnje, na sedež z

AKTIVNO ČELNO ZRAČNO BLAZINO, saj pri tem obstaja nevarnost RESNIH ali SMRTNIH POŠKODB za OTROKA.

SR: NIKADA ne koristiti bezbednosni sistem za decu u kome su deca okrenuta unazad na sedištu sa AKTIVNIM VAZDUŠNIM JASTUKOM ispred sedišta zato što DETE može da NASTRADA ili da se TEŠKO POVREDI.

MK: НИКОГАШ не користете детско седиште свртено наназад на седиште заштитено со АКТИВНО ВОЗДУШНО ПЕРНИЧЕ пред него, затоа што детето може ДА ЗАГИНЕ или да биде ТЕШКО ПОВРЕДЕНО.

BG: НИКОГА не използвайте детска седалка, гледаща назад, върху седалка, която е защитена чрез АКТИВНА ВЪЗДУШНА ВЪЗГЛАВНИЦА пред нея - може да се стигне до СМЪРТ или СЕРИОЗНО НАРАНЯВАНЕ на ДЕТЕТО.

RO: Nu utilizați NICIODATĂ un scaun pentru copil îndreptat spre partea din spate a mașinii pe un scaun protejat de un AIRBAG ACTIV în fața sa;

acest lucru poate duce la DECESUL sau VĂTĂMAREA GRAVĂ a COPILULUI.

CS: NIKDY nepoužívejte dětský zádržný systém instalovaný proti směru jízdy na sedadle, které je chráněno před sedadlem AKTIVNÍM AIRBAGEM. Mohlo by dojít k VÁŽNĚMU PORANĚNÍ nebo ÚMRTÍ DÍTĚTE.

SK: NIKDY nepoužívajte detskú sedačku otočenú vzad na sedadle chránenom AKTÍVNYM AIRBAGOM, pretože môže dôjsť k SMRTI alebo VÁŽNYM ZRANENIAM DIEŤAŤA.

LT: JOKIU BŪDU nemontuokite atgal atgręžtos vaiko tvirtinimo sistemas sėdynėje, prieš kurią įrengta AKTYVI ORO PAGALVĖ, nes VAIKAS GALI ŽŪTI arba RIMTAI SUSIŽALOTI.

LV: NEKĀDĀ GADĪJUMĀ neizmantojiet uz aizmuguri vērstu bērnu sēdekļīti sēdvietā, kas tiek aizsargāta ar tās priekšā uzstādītu AKTĪVU DROŠĪBAS SPILVENU, jo pretējā gadījumā BĒRNS var gūt SMAGAS TRAUMAS vai IET BOJĀ.

ET: ÄRGE kasutage tahapoole suunatud lapseturvaistet istmel, mille ees on AKTIIVSE TURVAPADJAGA kaitstud iste, sest see võib põhjustada LAPSE SURMA või TÕSISE VIGASTUSE.

MT: QATT tuża trażżin għat-tfal li jħares lejn in-naħa ta' wara fuq sit protett b'AIRBAG ATTIV quddiemu; dan jista' jikkawża I-MEWT jew ĠRIEHI SERJI lit-TFAL.

GA: Ná húsáid srian sábháilteachta linbh cúil RIAMH ar shuíochán a bhfuil mála aeir ag feidhmiú os a chomhair. Tá baol BÁIS nó GORTÚ DONA don PHÁISTE ag baint leis.

Beyond the warning required by ECE R94.02, for safety reasons a forward-facing child restraint system must only be used subject to the instructions and restrictions in the table ⇨ 58.

The airbag label is located on both sides of the front passenger sun visor. Airbag deactivation ⇨ 54.

Front airbag system

The front airbag system consists of one airbag in the steering wheel and one in the instrument panel on the front passenger side. These can be identified by the word **AIRBAG**.

The front airbag system is triggered in the event of a front-end impact of a certain severity. The ignition must be switched on.

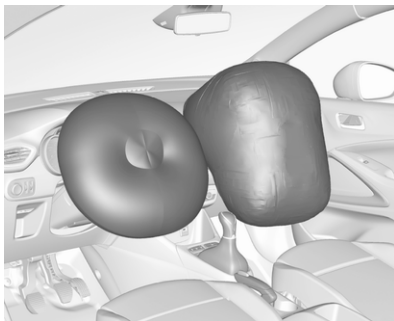

The inflated airbags cushion the impact, thereby reducing the risk of injury to the upper body and head of the front seat occupants considerably.

⚠ Warning

Optimum protection is only provided when the seat is in the proper position.

Seat position ⇨ 41.

Keep the area in which the airbag inflates clear of obstructions.

Fit the seat belt correctly and engage securely. Only then is the airbag able to protect.

Side airbag system



The side airbag system consists of an airbag in each front seat backrest. This can be identified by the word **AIRBAG**.

The side airbag system is triggered in the event of a side impact of a certain severity. The ignition must be switched on.



The inflated airbags cushion the impact, thereby reducing the risk of injury to the upper body and pelvis in the event of a side-on collision considerably.

⚠ Warning

Keep the area in which the airbag inflates clear of obstructions.

Notice

Only use protective seat covers that have been approved for the vehicle. Be careful not to cover the airbags.

Curtain airbag system

The curtain airbag system consists of an airbag in the roof frame on each side. This can be identified by the word **AIRBAG** on the roof pillars.

The curtain airbag system is triggered in the event of a side-on impact of a certain severity. The ignition must be switched on.

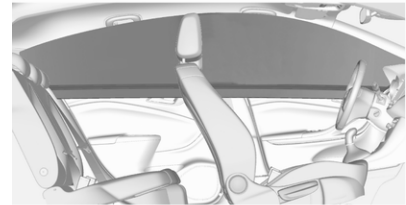

The inflated airbags cushion the impact, thereby reducing the risk of injury to the head in the event of a side-on impact considerably.

⚠ Warning

Keep the area in which the airbag inflates clear of obstructions.

The hooks on the handles in the roof frame are only suitable for hanging up light articles of clothing, without coat hangers. Do not keep any items in these clothes.

Airbag deactivation

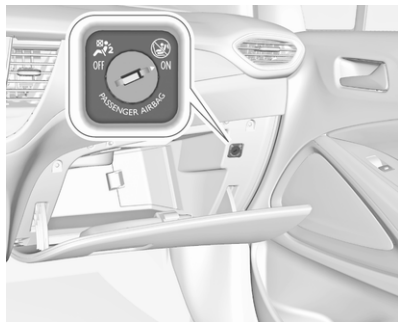

The front passenger airbag system must be deactivated for child restraint system on the passenger seat according to the instructions in the table ⇨ 58. The side airbag and curtain airbag systems, the belt pretensioners and all driver airbag systems will remain active.



The front passenger airbag system can be deactivated via a key-operated switch on the passenger side of the instrument panel.

Change status only when the vehicle is stopped with the ignition off.

Switch positions:

-  **OFF** : front passenger airbag is deactivated and will not inflate in the event of a collision. Control indicator  **OFF** illuminates continuously in the centre console
-  **ON** : front passenger airbag is active

Danger

Deactivate passenger airbag only in combination with the use of a child restraint system, subject to the instructions and restrictions in the table ⇨ 58.

Otherwise, there is a risk of fatal injury for a person occupying a seat with a deactivated front passenger airbag.



If the control indicator  **ON** illuminates for approx. 60 seconds after the ignition is switched on, the front passenger airbag system will inflate in the event of a collision.

If the control indicator  **OFF** illuminates after the ignition is switched on, the front passenger airbag system is deactivated. It stays on while the airbag is deactivated.

If both control indicators are illuminated at the same time, there is a system failure. The status of the system is not discernible, therefore no person is allowed to occupy the front passenger seat. Contact a workshop immediately.

Consult a workshop immediately if neither of the two control indicators are illuminated.

Control indicator for airbag deactivation ⇨ 83.

Child restraints

Child restraint systems

Danger

If using a rear-facing child restraint system on the front passenger seat, the airbag system for the front passenger seat must be deactivated. This also applies to certain forward-facing child restraint systems as indicated in the tables ⇨ 58.

Airbag deactivation ⇨ 54.

Airbag label ⇨ 49.

We recommend a child restraint system which is tailored specifically to the vehicle. For further information, contact your workshop.

Before fastening a child seat adjust the head restraint ⇨ 40.

When a child restraint system is being used, pay attention to the following usage and installation instructions and also those supplied with the child restraint system.

Always comply with local or national regulations. In some countries, the use of child restraint systems is forbidden on certain seats.

Child restraint systems can be fastened with:

- Three-point seat belt
- ISOFIX brackets
- Top-tether anchor

Three-point seat belt

Child restraint systems can be fastened by using a three-point seat belt. After fastening the child restraint system the seat belt has to be tightened ⇨ 58.

ISOFIX brackets



Fasten vehicle-approved ISOFIX child restraint systems to the ISOFIX brackets. Specific vehicle ISOFIX child restraint system positions are marked in the ISOFIX table ↗ 58.

ISOFIX brackets are indicated by a label on the backrest.

An i-Size child restraint system is an universal ISOFIX child restraint system according UN Regulation No. 129.

All i-Size child restraint systems can be used on any vehicle seat suitable for i-Size, i-Size table ↗ 58.

Either a Top-tether strap or a support leg must be used in addition to the ISOFIX brackets.



i-Size child seats and vehicle seats with i-Size approval are marked with i-Size symbol, see illustration.

Top-tether anchors

Top-tether anchors are marked with the symbol  for a child seat.



In addition to the ISOFIX brackets, fasten the Top-tether strap to the Top-tether anchors.

ISOFIX child restraint systems of universal category positions are marked in the table by IUF ↗ 58.

Selecting the right system

The rear seats are the most convenient location to fasten a child restraint system.

Children should travel facing rearwards in the vehicle as long as possible. This makes sure that the child's backbone, which is still very weak, is under less strain in the event of an accident.

Suitable are restraint systems that comply with valid UN ECE regulations. Check local laws and regulations for mandatory use of child restraint systems.

The following child restraints are recommended for the following weight classes:

- Maxi Cosi Cabriofix for group 0, group 0+
- Duo Plus for group I

- Kidfix XP for group II/III
- Graco Junior for group III

Ensure that the child restraint system to be installed is compatible with the vehicle type.

Ensure that the mounting location of the child restraint system within the vehicle is correct, see following tables.

Allow children to enter and exit the vehicle only on the side facing away from the traffic.

When the child restraint system is not in use, secure the seat with a seat belt or remove it from the vehicle.

Notice

Do not affix anything on the child restraint systems and do not cover them with any other materials.

A child restraint system which has been subjected to stress in an accident must be replaced.

Child restraint installation locations

Permissible options for fastening a child restraint system with a three-point seat belt

Weight class	On front passenger seat		On rear outer seats	On rear centre seat
	activated airbag	deactivated airbag		
Group 0: up to 10 kg	X	U/L ^{1,2}	U/L ³	X
Group 0+: up to 13 kg	X	U/L ^{1,2}	U/L ³	X
Group I: 9 to 18 kg	X	U/L ^{1,2}	U/L ^{3,4}	X
Group II: 15 to 25 kg	U/L ^{1,2}	X	U/L ^{3,4}	X
Group III: 22 to 36 kg	U/L ^{1,2}	X	U/L ^{3,4}	X

U : universal suitability in conjunction with three-point seat belt

L : suitable for particular child restraint systems of the 'specific-vehicle', 'restricted' or 'semi-universal' categories. The child restraint system must be approved for the specific vehicle type (refer to the vehicle type list of the child restraint system)

X : no child restraint system permitted in this weight class

¹ : move seat forwards as far as necessary and adjust seat backrest inclination as far as necessary to a vertical position to ensure that the seat belt runs forwards from the upper anchorage point

² : move seat height adjustment upwards as far as necessary,
adjust seat backrest inclination as far as necessary to a vertical position to ensure that the seat belt is tight on the buckle side

³ : move the respective front seat ahead of the child restraint system forwards and the sliding rear seat backwards as far as necessary

⁴ : adjust the respective headrest as necessary or remove if required

Permissible options for fitting an ISOFIX child restraint system with ISOFIX brackets

Weight class	Size class	Fixture	On front passenger seat		On rear outer seats	On rear centre seat
			activated airbag	deactivated airbag		
Group 0: up to 10 kg	G	ISO/L2	X	X	X	X
	F	ISO/L1	X	X	X	X
	E	ISO/R1	X	X	IL ¹	X
Group 0+: up to 13 kg	E	ISO/R1	X	X	IL ¹	X
	D	ISO/R2	X	X	IL ¹	X
	C	ISO/R3	X	X	IL ¹	X
Group I: 9 to 18 kg	D	ISO/R2	X	X	IL ^{1,2}	X
	C	ISO/R3	X	X	IL ^{1,2}	X
	B	ISO/F2	X	X	IL, IUF ^{1,2}	X
	B1	ISO/F2X	X	X	IL, IUF ^{1,2}	X
	A	ISO/F3	X	X	IL, IUF ^{1,2}	X
Group II: 15 to 25 kg			X	X	IL ^{1,2}	X
Group III: 22 to 36 kg			X	X	IL ^{1,2}	X

- IL : suitable for particular ISOFIX restraint systems of the 'specific-vehicle', 'restricted' or 'semi-universal' categories.
The ISOFIX restraint system must be approved for the specific vehicle type (refer to the vehicle type list of the child restraint system)
- IUF : suitable for ISOFIX forward-facing child restraint systems of universal category approved for use in this weight class
- X : no ISOFIX child restraint system approved in this weight class
- ¹ : move the respective front seat ahead of the child restraint system forwards and the sliding rear seat backwards as far as necessary
- ² : adjust the respective headrest as necessary or remove if required

ISOFIX size class and seat device

- A – ISO/F3 : forward-facing child restraint system for children of maximum size in the weight class 9 to 18 kg
- B – ISO/F2 : forward-facing child restraint system for smaller children in the weight class 9 to 18 kg
- B1 – ISO/F2X : forward-facing child restraint system for smaller children in the weight class 9 to 18 kg
- C – ISO/R3 : rear-facing child restraint system for children of maximum size in the weight class up to 18 kg
- D – ISO/R2 : rear-facing child restraint system for smaller children in the weight class up to 18 kg
- E – ISO/R1 : rear-facing child restraint system for young children in the weight class up to 13 kg
- F – ISO/L1 : left lateral facing position child restraint system (carry-cot)
- G – ISO/L2 : right lateral facing position child restraint system (carry-cot)

Permissible options for fitting an i-Size child restraint system with ISOFIX brackets

	On front passenger seat			
	activated airbag	deactivated airbag	On rear outer seats	On rear centre seat
i-Size child restraint systems	X	X	i - U	X

- i - U : suitable for i-Size 'universal' forward and rearward facing child restraint systems
- X : seating position not suitable for i-Size 'universal' child restraint systems

Storage

Storage compartments	61
Glovebox	61
Cupholders	61
Centre console storage	62
Load compartment	62
Load compartment cover	64
Rear floor storage cover	64
Lashing eyes	65
Warning triangle	66
First aid kit	66
Roof rack system	67
Roof rack	67
Loading information	67

Storage compartments

⚠ Warning

Do not store heavy or sharp objects in the storage compartments. Otherwise, the storage compartment lid could open and vehicle occupants could be injured by objects being thrown around in the event of hard braking, a sudden change in direction or an accident.

Glovebox

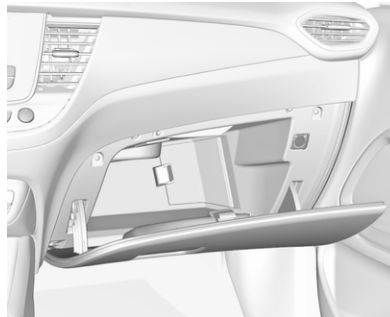

The glovebox should be closed whilst driving.

Cooled glovebox

Air ventilation and temperature depend on the settings of the climate control system. The air vent in the glovebox can be closed ⇨ 120.

Cupholders

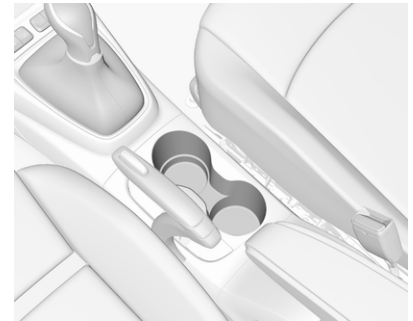

Cupholders are located in the centre console.

Centre console storage

The storage container can be used to store small items.

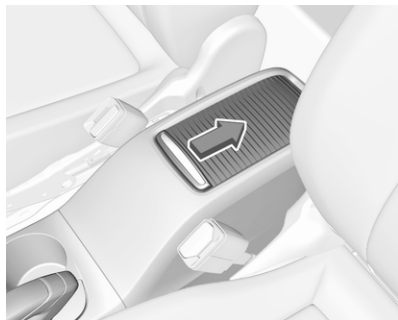

Depending on the version, the storage compartment is located under a cover.

Load compartment

The rear seat backrest is divided in two parts. Both parts can be folded down.

Warning

When folding up, ensure that backrests are securely locked in position before driving. Failure to do so may result in personal injury or damage to the load or vehicle in the event of hard braking or a collision.

Before folding rear seat backrests, execute the following if necessary:

- Remove the load compartment cover ⇨ 64.
- Press and hold the catch to push the head restraints down ⇨ 40.



- Insert the seat belts in the guiding latches.

Load compartment extension (version with lever)



- Pull the lever on one or both outer sides and fold down the backrests onto the seat cushion.
- To fold up, raise the backrests and guide them into an upright position until they engage audibly.

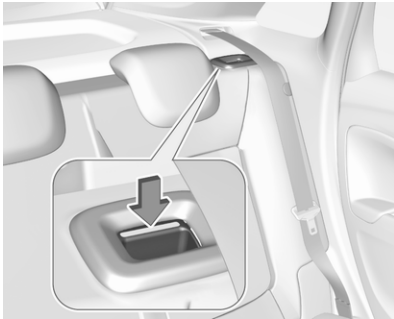

The backrests are properly engaged when the red mark near the lever is no longer visible.

Load compartment extension (version with loop)

- Move both rear seats to the most rearward position ⇨ 45.

- Fold up rear armrest before folding down the relevant part of the backrest. Otherwise this part of the backrest cannot be folded down.



- Pull the loop and fold down the backrest onto the seat cushion.
- To fold up, raise the backrests and guide them into an upright position until they engage audibly.

Folding rear armrest

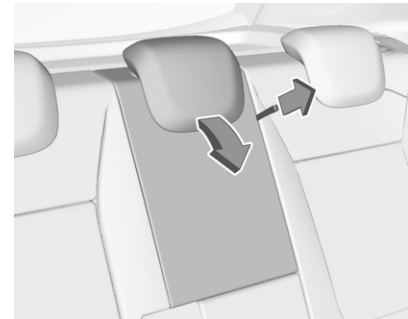

Pull the loop to fold down the rear armrest.

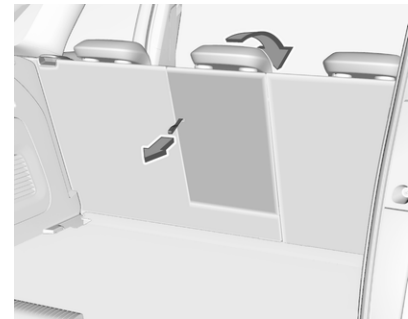

The armrest can also be folded down from the load compartment by pulling the loop and pushing the centre backrest.

The centre backrest is properly engaged when the red mark on the loop is no longer visible.

Load compartment cover

Do not place any objects on the cover.

Removing cover

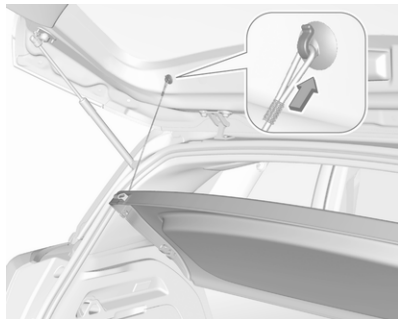

Unhook retaining straps from tailgate.

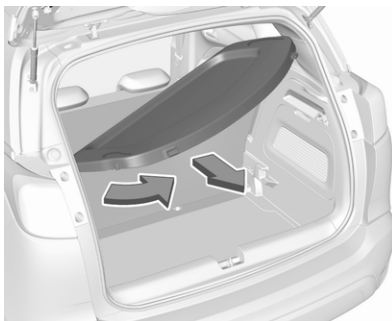

Lift cover, slightly angle and turn it. Remove the cover.

Stowing



The load compartment cover can be stored behind the rear seat backrests.

Unhook retaining straps and lift the cover backwards until it unlatches. Then slide it down in the guides behind the seat backrests.

Fitting cover

Engage cover in side guides and fold downwards. Attach the retaining straps to the tailgate.

Rear floor storage cover

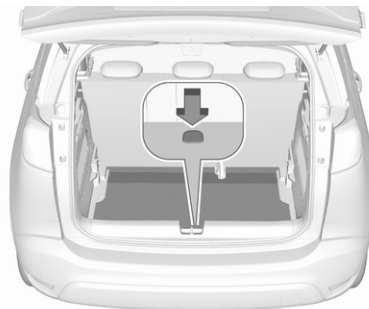

Raise cover at the recess to gain access to emergency breakdown equipment.

Tyre repair kit ⇨ 203.

Spare wheel ⇨ 207.

Double load floor

The double load floor can be inserted in the load compartment in two positions:



- lower position above the rear floor storage cover
- upper position interlocked with the grab handle into back panel trim

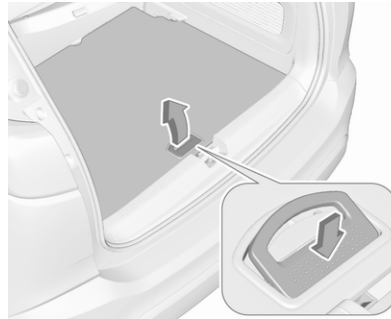

To remove, press the handle to unlock the load floor and lift it up while using the handle.

If mounted in the upper position, the space between the load floor and the spare wheel well cover can be used as a storage compartment.

In this position, if the rear seat backrests are folded forwards, an almost completely flat load bay is created.

In the upper position, the double load floor is able to withstand a maximum load of 100 kg. In the lower position, the double load floor is able to withstand the maximum permissible load.

Lashing eyes



The lashing eyes are designed to secure items against slippage, e.g. using lashing straps or luggage net.

Warning triangle



Stow the warning triangle in the space at the rear of the load compartment and secure it with the Velcro® fastener.

First aid kit

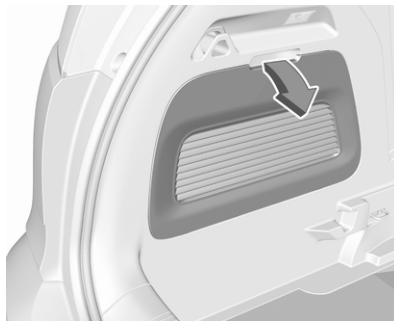

Fold down the cover on the left side of the load compartment.



Stow the first aid kit in the storage compartment.

Roof rack system

Roof rack

For safety reasons and to avoid damage to the roof, the vehicle-approved roof rack system is recommended.

Follow the installation instructions and remove the roof rack when not in use.

Mounting roof rack

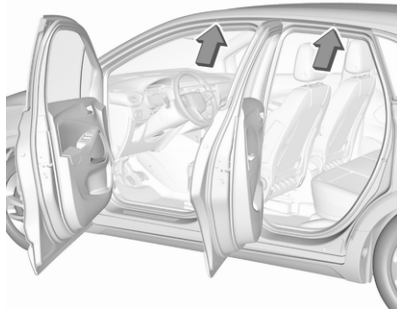

Open all doors.

Mounting points are located in each door frame of the vehicle body.

Detach the cover from each mounting point and fasten the roof rack with the attached screws.

Loading information



- Heavy objects in the load compartment should be placed against the seat backrests. Make sure that the backrests are securely engaged ⇨ 62. If objects can be stacked, heavier objects should be placed at the bottom.
- Prevent sliding of loose objects by securing them with straps attached to the lashing eyes ⇨ 65.
- Do not allow the load to protrude above the upper edge of the backrests.

- Do not place any objects on the load compartment cover or the instrument panel, and do not cover the sensor on top of the instrument panel.
- The load must not obstruct the operation of the pedals, parking brake and gear selector, or hinder the freedom of movement of the driver. Do not place any unsecured objects in the interior.
- Do not drive with an open load compartment.

Warning

Always make sure that the load in the vehicle is securely stowed. Otherwise objects can be thrown around inside the vehicle and cause personal injury or damage to the load or car.

- The payload is the difference between the permitted gross vehicle weight (see identification plate ⇨ 224) and the EC kerb weight, refer to the EEC Certificate of Conformity provided with your vehicle or

other national registration documents.

To calculate the payload, enter the data for your vehicle in the weights table at the front of this manual.

The EC kerb weight includes weights for the driver (68 kg), luggage (7 kg) and all fluids (fuel tank 90% full).

Optional equipment and accessories increase the kerb weight.

- Driving with a roof load increases the sensitivity of the vehicle to cross-winds and has a detrimental effect on vehicle handling due to the vehicle's higher centre of gravity.

Distribute the load evenly and secure it properly with retaining straps. Adjust the tyre pressure and vehicle speed according to the load conditions. Check and retighten the straps frequently.

Do not drive faster than 75 mph.

The permissible roof load is 60 kg. The roof load is the

combined weight of the roof rack and the load.

Instruments and controls

Controls	70
Steering wheel adjustment	70
Steering wheel controls	70
Heated steering wheel	70
Horn	71
Windscreen wiper and washer ..	71
Rear window wiper and washer	73
Outside temperature	73
Clock	74
Power outlets	74
Inductive charging	75
Cigarette lighter	76
Ashtrays	76
Warning lights, gauges and indicators	77
Instrument cluster	77
Speedometer	79
Odometer	79
Trip odometer	79
Tachometer	80
Fuel gauge	80
Engine coolant temperature gauge	80

Engine oil level monitor	81
Service display	81
Control indicators	82
Turn lights	82
Seat belt reminder	83
Airbag and belt tensioners	83
Airbag deactivation	83
Charging system	84
Malfunction indicator light	84
Service vehicle soon	84
Stop engine	84
System check	84
Brake and clutch system	85
Parking brake	85
Antilock brake system (ABS)	85
Gear shifting	85
Descent control system	86
Lane departure warning	86
Electronic Stability Control and Traction Control system	86
Electronic Stability Control and Traction Control system off	86
Engine coolant temperature	86
Preheating	86
Exhaust filter	86
AdBlue	87
Deflation detection system	87
Engine oil pressure	87
Low fuel	87
Autostop	88

Exterior light	88
Low beam	88
High beam	88
High beam assist	88
Front fog lights	88
Rear fog light	88
Rain sensor	88
Cruise control	88
Side blind spot alert	88
Active emergency braking	88
Speed limiter	89
Door open	89
Displays	89
Driver Information Centre	89
Info Display	92
Head-up display	93
Vehicle messages	95
Warning chimes	95
Vehicle personalisation	96
Telematics services	99
Vauxhall Connect	99
ERA GLONASS	100

Controls

Steering wheel adjustment

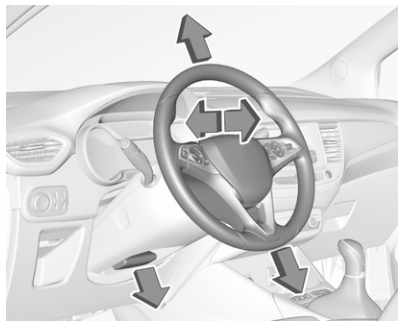

Unlock lever, adjust steering wheel, then engage lever and ensure it is fully locked.

Do not adjust steering wheel unless vehicle is stationary and steering wheel lock has been released.

Steering wheel controls



Cruise control and speed limiter are operated via the controls on the left side of the steering wheel.

On the same side is located the switch for the heated steering wheel.

Infotainment system can be operated via the controls on the right side of the steering wheel.

Driver assistance systems ⇨ 144.

Further information is available in the Infotainment manual.

Heated steering wheel ⇨ 70.

Heated steering wheel

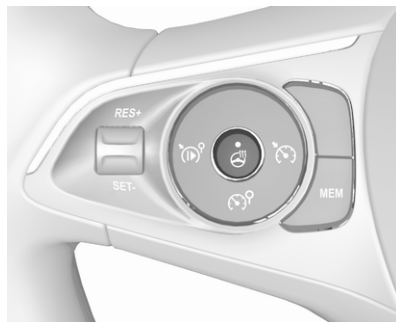

Activate heating by pressing . Activation is indicated by the LED in the button.

Heating is operational when the engine is running and during an Autostop.

Stop-start system ⇨ 127.

Horn

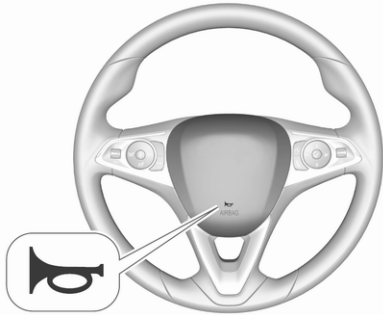

Press .

Windscreen wiper and washer

Windscreen wiper with adjustable wiper frequency

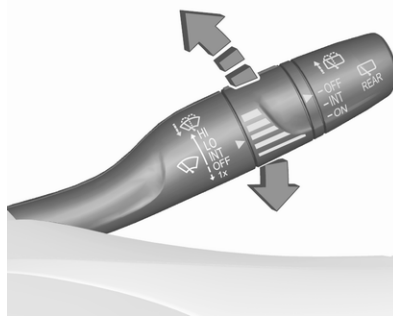

- HI** : fast
- LO** : slow
- INT** : interval wiping
- OFF** : off
- 1x** : single wipe

Do not use if the windscreen is frozen.
Switch off in car washes.

To activate interval wiping mode the next time ignition is switched on, press the lever downwards to position **OFF** and back to **INT**.

Adjustable wiper frequency

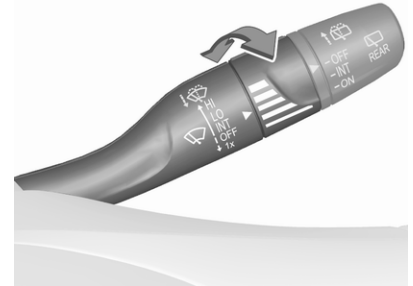

Wiper lever in position **INT**.

Turn the adjuster wheel to adjust the wiping frequency.

Windscreen wiper with rain sensor

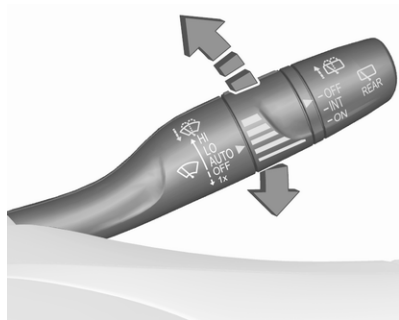

- HI** : fast
LO : slow
AUTO : automatic wiping with rain sensor
OFF : off
1x : single wipe

In **AUTO** position, the rain sensor detects the amount of water on the windscreen and automatically regulates the frequency of the windscreen wiper. If ignition is switched off, automatic wiping mode is deactivated. To activate automatic wiping mode the next time ignition is

switched on, press the lever downwards to position **OFF** and back to **AUTO**.

Do not use if the windscreen is frozen.
Switch off in car washes.

Adjustable sensitivity of the rain sensor

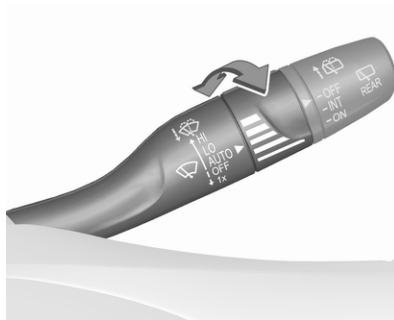

Wiper lever in position **AUTO**.

Turn the adjuster wheel to adjust the sensitivity of the rain sensor.

Make sure the sensor is not blocked
↻ 35, ↻ 10.

Control indicator  ↻ 71.

Windscreen washer

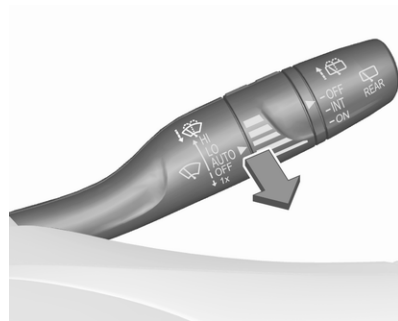

Pull lever. Washer fluid is sprayed onto the windscreen and the wiper wipes a few times.

Washer fluid ↻ 181.

Rear window wiper and washer

Rear window wiper



OFF : off

INT : intermittent operation

Do not use if the rear window is frozen.

Switch off in car washes.

The rear window wiper comes on automatically when the windscreen wiper is switched on and reverse gear is engaged.

Activation or deactivation of this function can be changed in the Vehicle personalisation menu ↪ 96.

Rear window washer

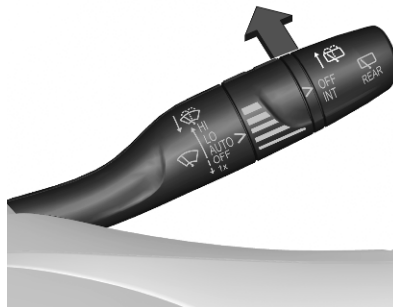

Push lever.

Washer fluid is sprayed onto the rear window and the wiper wipes a few times.

The rear window washer system is deactivated when the fluid level is low.

Washer fluid ↪ 181.

Outside temperature

A drop in temperature is indicated immediately and a rise in temperature after a time delay.



Illustration shows an example.

If outside temperature drops to 3 °C, a warning message is displayed in the Driver Information Centre.

Warning

The road surface may already be icy even though the display indicates a few degrees above 0 °C.

Clock

Date and time are shown in the Info Display ↗ 92.

Setting date and time, see Infotainment manual.

Power outlets



A 12 V power outlet is located in the centre console.

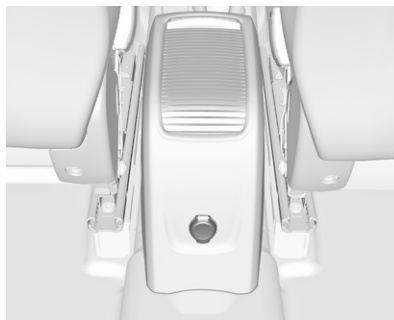

Another power outlet is located in the console between the front seats.

Do not exceed the maximum power consumption of 120 W.

With ignition off, the power outlet is deactivated. Additionally, the power outlet is deactivated in the event of low vehicle battery voltage.

Electrical accessories that are connected must comply with the electromagnetic compatibility requirements laid down in DIN VDE 40 839.

Do not connect any current-delivering accessories, e.g. electrical charging devices or batteries.

Do not damage the outlets by using unsuitable plugs.

Stop-start system ↗ 127.

USB charging port

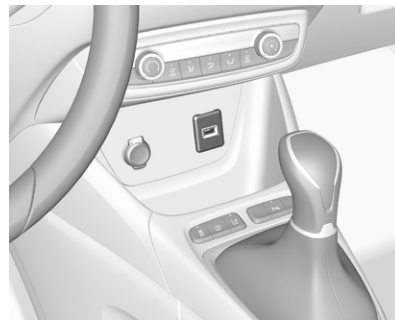

One or two USB ports are prepared for charging devices.

When two USB ports are available, the upper USB port can be used to connect a phone for phone projection.

Notice

The sockets must always be kept clean and dry.

USB port and phone projection see Infotainment manual.

Inductive charging

⚠ Warning

Inductive charging can affect the operation of implanted pacemakers or other medical devices. If applicable, seek medical advice before using the inductive charging device.

⚠ Warning

Remove any metal objects from the charging device before charging a mobile device, as these objects could become very hot.



To charge a mobile device:

1. Remove all objects from the charging device.
2. Place the mobile device with the display facing upwards on the charging device.
3. LED illuminates green, when mobile device is charging.

The mobile device must be smaller than 7 cm by 15 cm to fit into the charging device.

PMA or Qi compatible mobile devices can be charged inductively.

On some mobile devices, a back cover with an integrated coil or a jacket may be required to use inductive charging.

Protective cover for the mobile device could have impact on the inductive charging.

LED illuminates yellow, when

- metal objects have been detected in the charging area
- mobile device was not placed properly.

In the case that the mobile device is not charging properly:

1. Remove the mobile device from the charging device.
2. Rotate the mobile device by 180°.
3. Wait 3 seconds after the LED has extinguished and place the mobile device on the charging device again.

Cigarette lighter



Press in the cigarette lighter. It switches off automatically once the element is glowing. Pull out the cigarette lighter.

Ashtrays

Caution

To be used only for ash and not for combustible rubbish.

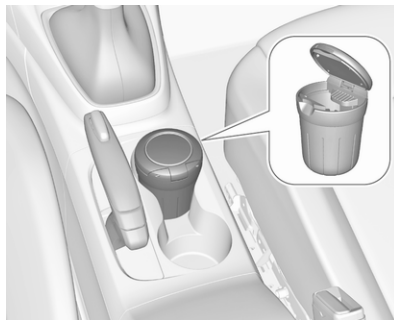

A portable ashtray can be placed in the cupholders.

Warning lights, gauges and indicators

Instrument cluster

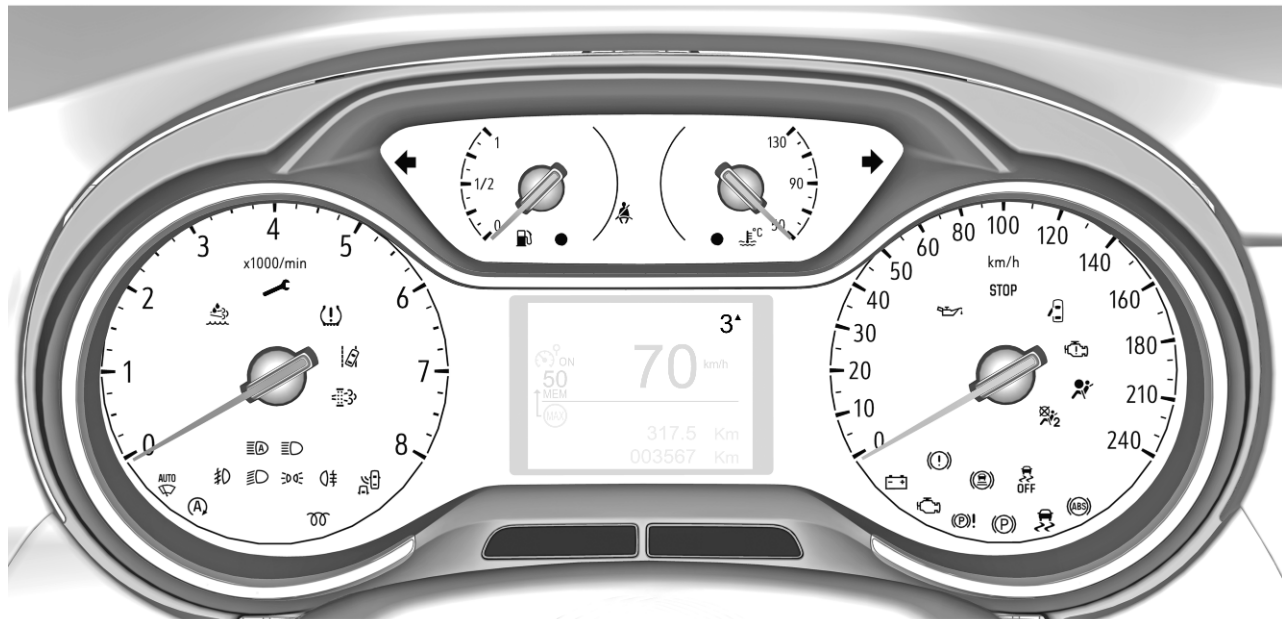

Overview

 Turn lights ⇨ 82

 Seat belt reminder ⇨ 83

 Airbag and seat belt tensioners ⇨ 83

 Airbag deactivation ⇨ 83

 Charging system ⇨ 84

 Malfunction indicator light ⇨ 84

 Service vehicle soon ⇨ 84

STOP Stop engine ⇨ 84

 System check ⇨ 84

 Brake and clutch system ⇨ 85

 Parking brake ⇨ 85

 Antilock brake system (ABS) ⇨ 85

 Gear shifting ⇨ 85

 Lane departure warning ⇨ 86

 Electronic Stability Control and Traction Control system ⇨ 86

 Electronic Stability Control and Traction Control system off ⇨ 86



 Engine coolant temperature high ⇨ 86

 Preheating ⇨ 86

 Exhaust filter ⇨ 86

 AdBlue ⇨ 87

 Deflation detection system ⇨ 87

 Engine oil pressure ⇨ 87
 Engine oil level monitor ⇨ 81

 Low fuel ⇨ 87

 Autostop ⇨ 88

 Exterior light ⇨ 88

 Low beam ⇨ 88

 High beam ⇨ 88

 High beam assist ⇨ 88

 Descent control system ⇨ 86

 Front fog lights ⇨ 88

 Rear fog light ⇨ 88

 Rain sensor ⇨ 88

 Cruise control ⇨ 88

 Side blind spot alert ⇨ 88

 Active emergency braking ⇨ 88

 Speed limiter ⇨ 89

 Door open ⇨ 89

Speedometer



Indicates vehicle speed.

Odometer

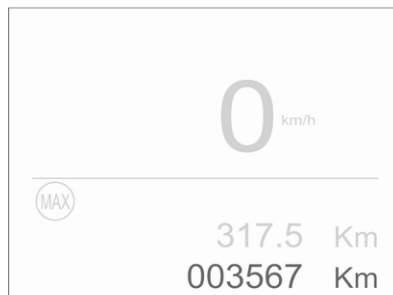

The total recorded distance is displayed in miles.

Trip odometer

The recorded distance since the last reset is displayed in the Driver Information Centre.

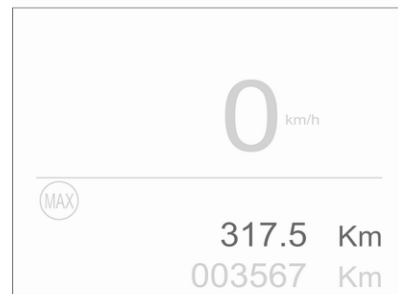

Monochrome display

Trip odometer counts up to 9,999.9 miles without automatic reset.

Press **000** for 2 seconds to reset trip odometer.

Colour display

Trip odometer counts up to 1,999.9 miles and resets then automatically.

Press **000** for 2 seconds to reset trip odometer.

The trip / fuel information menu provides additionally two trip counter
 ⇨ 89.

Tachometer

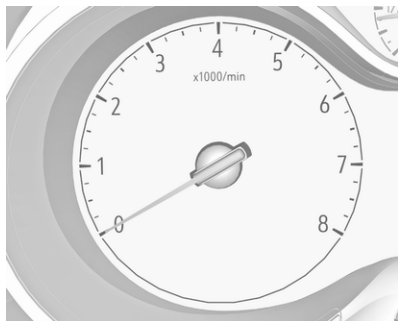

Displays the engine speed.

Drive in a low engine speed range for each gear as much as possible.

A red marker indicates the beginning of the warning zone of excessive revolutions. For Diesel engines, the warning zone starts at 5000 revolutions per minute. For petrol engines, the warning zone starts at 7000 revolutions per minute.

Caution

If the needle is in the red warning zone, the maximum permitted engine speed is exceeded. Engine at risk.

Fuel gauge



Displays the fuel level in the tank.

Control indicator ● illuminates if the level in the tank is low.

Never run the fuel tank dry.

Because of the fuel remaining in the tank, the top-up quantity may be less than the specified fuel tank capacity.

Engine coolant temperature gauge

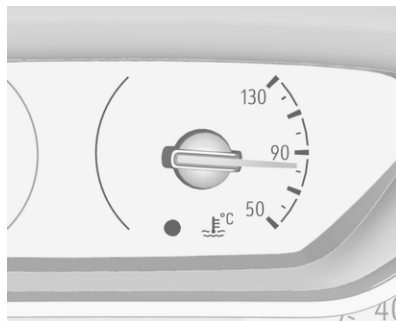

Displays the coolant temperature.

50 : engine operating temperature not yet reached

90 : normal operating temperature

130 : temperature too high

Control indicator ● illuminates if engine coolant temperature is too high.



Caution

If engine coolant temperature is too high, stop vehicle, switch off engine. Danger to engine. Check coolant level.

Engine oil level monitor

The state of the engine oil level is displayed in the Driver Information Centre for a few seconds following the service information after switching on the ignition.

A proper state of engine oil level is indicated by the message **Oil level correct**.

If engine oil level is low,  flashes and **Oil level incorrect** is indicated, accompanied by the  indicator. Confirm engine oil level by using the dipstick and top up engine oil respectively.

Engine oil ⇨ 180.

A fault of measurement is indicated by the message **Oil level measurement invalid**. Check engine oil level manually by using the dipstick.

Service display

The service system informs when to change the engine oil and filter or a vehicle service is required. Based on driving conditions, the interval at which an engine oil and filter change is required can vary considerably.

Service information ⇨ 218.

A required service due is displayed in the Driver Information Centre for 7 seconds after switching on the ignition.

If no service is required for the next 1800 miles or more no service information appears in the display.

If service is required within the next 1800 miles, the remaining distance or time duration is indicated for several seconds. Simultaneously  illuminates permanently as reminder.

If service is required in less than 600 miles,  flashes and then illuminates permanently. Remaining distance or time duration is indicated for several seconds.

Overdue service is indicated by a message in the Driver Information Centre which indicates the overdue distance.  flashes and then illuminates permanently until service is executed.

Reset of service interval

After each service, the service indicator must be reset to ensure proper functionality. It is recommended to seek the assistance of a workshop.

Operate as following:

- switch off ignition
- press and hold button  or **CHECK**
- switch on ignition, the distance indication begins a countdown
- when the display indicates =0, release the button

The  disappears.

Retrieving service information

To retrieve the status of the service information at any time press left button underneath the Driver Information Centre.



Or



The service information is displayed for a few seconds.

Service information ⇨ 218.

Control indicators

The control indicators described are not present in all vehicles. The description applies to all instrument versions.

Depending on the equipment, the position of the control indicators may vary. When the ignition is switched on, most control indicators will illuminate briefly as a functionality test.

The control indicator colours mean:

- red : danger, important reminder
- yellow : warning, information, fault
- green : confirmation of activation
- blue : confirmation of activation
- white : confirmation of activation
- grey : system paused, at least one system limitation has been detected

Instrument cluster overview ⇨ 77.

Turn lights

⇨ illuminates or flashes green.

Illuminates briefly

The parking lights are switched on.

Flashes

A turn light or the hazard warning flashers are activated.

Rapid flashing: failure of a turn light or associated fuse.

This includes turn lights connected to the socket of the towing equipment.

Bulb replacement ⇨ 185.

Fuses ⇨ 193.

Turn lights ⇨ 106.

Seat belt reminder



Seat belt reminder on all seats

 illuminates or flashes red in the instrument cluster together with the indication in the overhead console for each seat belt.



- When the ignition is switched on,  in the instrument cluster and the symbol for the respective seat in the overhead console

comes on, if the seat belt of any occupied seat has not been fastened.

- After driving off,  in the instrument cluster and the symbol for the respective seat in the overhead console flashes for a certain time together with a chime. After a certain time of driving  illuminates constantly until the seat belt of the respective seat has been fastened or if any passenger has unfastened the seat belt.

Seat belts ⇨ 46.

Airbag and belt tensioners

 illuminates red.

When the ignition is switched on, the control indicator illuminates for approx. 4 seconds. If it does not illuminate, does not go out after 4 seconds or illuminates whilst driving, there is a fault in the airbag system. Seek the assistance of a workshop. The airbags and belt pretensioners may fail to trigger in the event of an accident.

Deployment of the belt pretensioners or airbags is indicated by continuous illumination of .

Warning

Have the cause of the fault remedied immediately by a workshop.

Belt pretensioners ⇨ 46.

Airbag system ⇨ 49.

Airbag deactivation



 ON illuminates yellow.

The front passenger airbag is activated.

 OFF illuminates yellow.

The front passenger airbag is deactivated.

Airbag deactivation ⇨ 54.

Charging system

 illuminates red.

Illuminates when the ignition is switched on and extinguishes shortly after the engine starts.

Illuminates when the engine is running

Stop, switch off engine. Vehicle battery is not charging. Engine cooling may be interrupted. The brake servo unit may cease to be effective. Seek the assistance of a workshop.

Malfunction indicator light

 illuminates or flashes yellow.

Illuminates when the ignition is switched on and extinguishes shortly after the engine starts.

Illuminates when the engine is running

Fault in the emission control system. The permitted emission limits may be exceeded.

Seek the assistance of a workshop immediately.

Flashes when the engine is running

The engine management system has a fault that could lead to catalytic converter damage. Ease up on the accelerator until the flashing stops. Seek the assistance of a workshop immediately.

Service vehicle soon

 illuminates yellow.

Illuminates briefly when the ignition is switched on.

May illuminate together with other control indicators and a corresponding message in the Driver Information Centre.

Seek the assistance of a workshop immediately.

Stop engine

STOP illuminates red.

Illuminates briefly when the ignition is switched on.

Illuminates together with other control indicators, accompanied by a warning chime and a corresponding message in the Driver Information Centre.

Stop engine immediately and seek the assistance of a workshop.

System check

 illuminates yellow or red.

Illuminates yellow

A minor engine fault has been detected.

Illuminates red

A major engine fault has been detected.

Stop engine as soon as possible and seek the assistance of a workshop.

Brake and clutch system

① illuminates red.

The brake and clutch fluid level is too low, when parking brake is not applied ⇨ 182.

⚠ Warning

Stop. Do not continue your journey. Consult a workshop.

Illuminates when the manual parking brake is applied and ignition is switched on ⇨ 139.

Brake fluid ⇨ 182.

Parking brake

Ⓢ illuminates red.

Illuminates when the parking brake is applied and ignition is switched on ⇨ 139.

Antilock brake system (ABS)

Ⓢ illuminates yellow.

Illuminates for a few seconds after the ignition is switched on. The system is ready for operation when the control indicator extinguishes.

If the control indicator does not go out after a few seconds, or if it illuminates while driving, there is a fault in the ABS. The brake system remains operational but without ABS regulation.

Antilock brake system ⇨ 138.

Gear shifting

Manual transmission

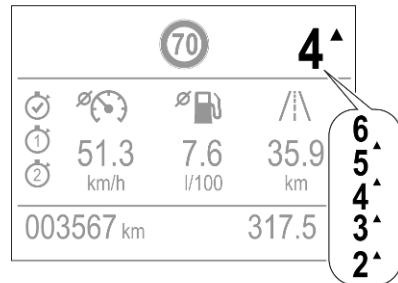

▲ with the number of a higher gear is indicated, when upshifting into this gear is recommended for fuel saving reasons.

Automatic transmission manual mode

▲ is indicated, when upshifting is recommended for fuel saving reasons.

Descent control system

 illuminates or flashes green.

Illuminates green

The system is switched on and ready to operate.

Flashes green

The system is in operation.

Lane departure warning

 flashes yellow when the system recognises an unintended lane change.

Lane departure warning ⇨ 167.

Electronic Stability Control and Traction Control system

 illuminates or flashes yellow.

Illuminates

A fault in the system is present. Continued driving is possible. Driving stability, however, may deteriorate depending on road surface conditions.

Have the cause of the fault remedied by a workshop.

Flashes

The system is actively engaged. Engine output may be reduced and the vehicle may be braked automatically to a small degree.

Electronic Stability Control and Traction Control system ⇨ 140.

Electronic Stability Control and Traction Control system off

 illuminates yellow.

The systems are deactivated.

Engine coolant temperature

● illuminates red.

Illuminates when the engine is running

Stop, switch off engine.

Caution

Coolant temperature too high.

Check coolant level immediately ⇨ 181.

If there is sufficient coolant, consult a workshop.

Preheating

 illuminates yellow.

Preheating of diesel engine is activated. Only activates when outside temperature is low. Start the engine when control indicator extinguishes.

Starting the engine ⇨ 125.

Exhaust filter

 or  illuminates yellow.

The exhaust filter requires cleaning.

Continue driving until the control indicator extinguishes.

Illuminates temporarily

Start of saturation of the exhaust filter.
Start cleaning process as soon as possible by driving at a vehicle speed of at least 40 mph.

Illuminates constantly

Indication of a low additive level. Seek the assistance of a workshop.
Exhaust filter ↻ 130.

AdBlue

 flashes or illuminates yellow.

Illuminates yellow

The remaining driving range is between 370 miles and 1500 miles.

Flashes yellow

The remaining driving range is between 0 and 370 miles.

AdBlue level is low. Refill AdBlue soon to avoid prevention of the engine start.

AdBlue ↻ 131.

Deflation detection system

 illuminates or flashes yellow.

Illuminates

Tyre pressure loss in one or more wheels. Stop immediately and check tyre pressure.

Flashes

Fault in system. Consult a workshop.
Deflation detection system ↻ 200.

Engine oil pressure

 illuminates red.

Illuminates when the ignition is switched on and extinguishes shortly after the engine starts.

Illuminates when the engine is running**Caution**

Engine lubrication may be interrupted. This may result in damage to the engine and / or locking of the drive wheels.

1. Select neutral gear.
2. Move out of the flow of traffic as quickly as possible without impeding other vehicles.
3. Switch off ignition.

⚠ Warning

When the engine is off, considerably more force is needed to brake and steer.

During an Autostop, the brake servo unit will still be operational.

Do not remove key until vehicle is stationary, otherwise the steering wheel lock could engage unexpectedly.

Keep engine turned off and let the vehicle be towed to a workshop
↻ 180.

Low fuel

● illuminates yellow.

Level in fuel tank is too low.

Refuelling ↻ 171.

Bleeding the diesel fuel system
 ⇨ 184.

Autostop

(A) illuminates or flashes green.

Illuminates green

Engine is in an Autostop.

Flashes green

Autostop is temporarily unavailable, or Autostop mode is invoked automatically.

Stop-start system ⇨ 127.

Exterior light

➤⚡ illuminates green.

The exterior lights are on ⇨ 102.

Low beam

☾D illuminates green.

Illuminated when low beam is on.

High beam

☾D illuminates blue.

Illuminated when high beam is on or during headlight flash ⇨ 103.

High beam assist

☾D illuminates green.

The high beam assist is activated
 ⇨ 103.

Front fog lights

☾D illuminates green.

The front fog lights are on ⇨ 106.

Rear fog light

☾‡ illuminates yellow.

The rear fog light is on ⇨ 107.

Rain sensor

☾ illuminates green.

Illuminated when automatic wiping with rain sensor is activated.

Windscreen wiper and washer ⇨ 71.

Cruise control

☾ illuminates in the Driver Information Centre.

Cruise control ⇨ 144.

Side blind spot alert

☾ illuminates green.

The system is active ⇨ 161.

Active emergency braking

☾ illuminates or flashes yellow.

Illuminates

The system has been deactivated or a fault has been detected.

Additionally, a warning message is displayed in the Driver Information Centre.

Check the reason of the deactivation ⇨ 151 and in case of a system fault, seek the assistance of a workshop.

Notice

(E) also illuminates if the seat belts of the front passengers are not fastened. In this case, active emergency braking is deactivated.

Flashes

The system is actively engaged. Depending on the situation, the vehicle may automatically brake moderately or hard.

Forward collision alert ⇨ 149.

Front pedestrian protection ⇨ 153.

Speed limiter

⚡ illuminates in the Driver Information Centre.

Speed limiter ⇨ 147.

Door open

🚪 illuminates red.

A door or the tailgate is open.

Displays

Driver Information Centre

The Driver Information Centre is located in the instrument cluster.

Depending on the version, the Driver Information Centre is available as monochrome or colour display.

Driver Information Centre indicates:

- overall and trip odometer
- digital speed indication
- trip / fuel information menu
- gear shift indication
- service information
- vehicle and warning messages
- driver assistance messages
- pop-up messages
- AdBlue information

Selecting menus and functions



Turn the adjuster wheel to select a page in the trip / fuel information menu.

Press **SET/CLR** to confirm or reset a function.

Vehicle and service messages are popped up in the Driver Information Centre if required. Scroll messages by turning the adjuster wheel. Confirm messages by pressing **SET/CLR**.

Additionally, some menus can be selected via the left button:



Press  to switch between the respective menus.

Or



Press **CHECK** to switch between the respective menus.

Vehicle messages ⇨ 95.

Trip / fuel information menu, monochrome display

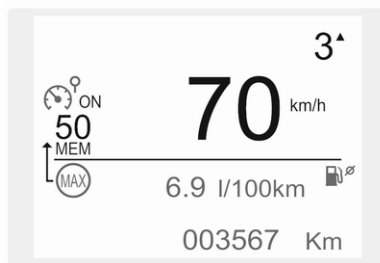

Turn the adjuster wheel to select a page:

Trip odometer

Trip odometer ⇨ 79.

Average fuel consumption

Display of average consumption. The measurement can be reset at any time and starts with a default value. To reset, press **SET/CLR** for a few seconds.

Average speed

Display of average speed. The measurement can be reset at any time.

To reset, press **SET/CLR** for a few seconds.

Fuel range

Range is calculated from current fuel level and current consumption. The display shows average values.

After refuelling, the range is updated automatically after a brief delay.

When the fuel level is low, a message appears on the display and the control indicator ● in the fuel gauge illuminates ⇨ 87.

Instantaneous Fuel Consumption

Display of the instantaneous consumption.

Digital speed

Digital display of the instantaneous speed and recognised speed limit.

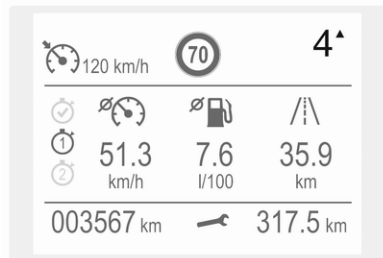
Trip / fuel information menu, colour display

Different pages with combined information can be selected.

Turn the adjuster wheel to select a page.

Information page:**Fuel range**

Range is calculated from current fuel level and current consumption. The display shows average values.

After refuelling, the range is updated automatically after a brief delay.

When the fuel level is low, a message appears on the display and the control indicator ● in the fuel gauge illuminates ⇨ 87.

Instantaneous Fuel Consumption

Display of the instantaneous consumption.

Trip 1 page:**Average speed**

Display of average speed. The measurement can be reset at any time.

Average fuel consumption

Display of average consumption. The measurement can be reset at any time and starts with a default value.

Distance travelled

Displays the current distance for trip 1 since the reset.

Trip odometer counts up to 9,999.9 miles without automatic reset.

The values of trip 1 page can be reset by pressing **SET/CLR** for a few seconds.

Trip 2 page:**Average speed**

Display of average speed. The measurement can be reset at any time.

Average fuel consumption

Display of average consumption. The measurement can be reset at any time and starts with a default value.

Distance travelled

Displays the current distance for trip 2 since a certain reset.

The values of trip 2 page can be reset by pressing **SET/CLR** for a few seconds.

Digital speed page

Digital display of the instantaneous speed.

Stop and Start time counter

A time counter calculates the time spent in STOP mode during a journey. It resets to zero every time the ignition is switched on.

Compass page

Displays the geographic direction of driving.

Blank page

No trip/fuel information is displayed.

AdBlue

Press  or **CHECK** repeatedly until the AdBlue menu is shown.

AdBlue range

Indicates an estimate of the AdBlue level. A message indicates whether the level is sufficient or low.

⇨ 131.

Info Display

The Info Display is located in the instrument panel near the instrument cluster.

Depending on the vehicle configuration the vehicle has a

- **Graphic Info Display**
or
- **7" Colour Info Display** with touchscreen functionality

or

- **8" Colour Info Display** with touchscreen functionality

The Info Display can indicate:

- time ⇨ 74
- outside temperature ⇨ 73
- date ⇨ 74
- Infotainment system, see description in the Infotainment manual
- indication of rear view camera ⇨ 166
- indication of panoramic view system ⇨ 163
- indication of parking assist instructions ⇨ 154
- navigation, see description in the Infotainment manual
- vehicle and system messages ⇨ 95
- settings for vehicle personalisation ⇨ 96

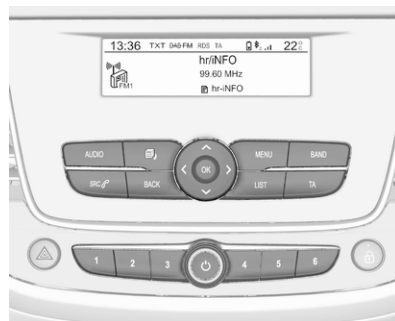
Graphic Info Display

Press  to switch on the display.

Press **MENU** to select main menu page.

Press   to select a menu page.

Press **OK** to confirm a selection.

Press **BACK** to exit a menu without changing a setting.

For further information, see Infotainment manual.

7" Colour Info Display**Selecting menus and settings**

Menus and settings are accessed via the touchscreen.



Press to switch on the display.

Press to display the homepage.

Touch required menu display icon.

Touch a respective icon to confirm a selection.

Touch to return to the next higher menu level.

Press to return to the homepage.

For further information, see Infotainment manual.

Vehicle personalisation 96.

8" Colour Info Display

Selecting menus and settings

There are three options to operate the display:

- via buttons below the display
- by touching the touchscreen
- via speech recognition

Button and touch operation



Press to switch on the display.

Press **SET** to select system settings (units, language, time and date).

Press to select vehicle settings or driving functions.

Touch required menu display icon or a function.

Confirm a required function or selection by touching.

Touch on the display to exit a menu without changing a setting.

For further information, see Infotainment manual.

Speech recognition

Description see Infotainment manual.

Vehicle personalisation 96.

Head-up display

The head-up display displays driver information onto a foldable projection plane on the driver's side.

The information appears as an image projected from a lens in the instrument panel onto the projection plane directly ahead in driver's view. The image appears focused out toward the front of the vehicle.

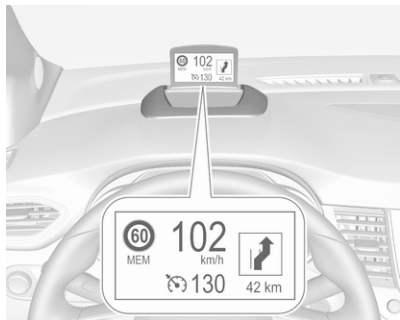

Head-up display views:

- vehicle speed
- speed limits by the traffic sign recognition
- set speed of speed limiter
- set speed of cruise control
- navigation information.



Adjust position of head-up display image

1. Adjust the driver's seat.
2. Start the engine.
3. Press Δ or ∇ to centre the image.
It can only be adjusted up and down, not side to side.



Warning

If the head-up display image is too bright or too high in your field of view, it may obstruct your view when it is dark outside. Be sure to

keep the head-up display image dim and placed low in your field of view.

Adjust brightness

The head-up display image will automatically dim and brighten to compensate for outside lighting. Brightness can also be adjusted manually as needed:

Press  to brighten the display. Press  to dim the display.

The image can temporarily illuminate depending on angle and position of sunlight.

Switching off

Press  and hold to turn the head-up display off.

Language

Preferred language can be set in vehicle personalisation menu  96.

Units

Units can be changed in vehicle personalisation menu  96.

Care of head-up display

Clean the projection plane of the head-up display with a soft cloth sprayed with glass cleaner. Wipe the lens gently, then dry it.

System limitations

Head-up display may not operate properly when:

- The lens in the instrument panel is covered by objects or not clean.
- Display brightness is too dim or bright.
- Image is not adjusted to the proper height.
- The driver wears polarised sunglasses.

If the head-up image is not correct for other reasons, contact a workshop.

Vehicle messages

Messages are indicated in the Driver Information Centre, in some cases together with a warning chime.

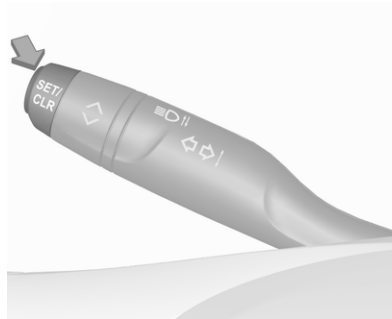

Press **SET/CLR** to confirm a message.

Vehicle and service messages

The vehicle messages are displayed as text. Follow the instructions given in the messages.

Messages in the Colour Info Display

Some important messages may appear additionally in the Info Display. Some messages only pop-up for a few seconds.

Warning chimes

If several warnings appear at the same time, only one warning chime will sound.

When starting the engine or whilst driving

The warning chime regarding not fastened seat belts has priority over any other warning chime.

- If a seat belt is not fastened.
- If a door or the tailgate is not fully closed when starting off.
- If a certain speed is exceeded with parking brake applied.
- If cruise control deactivates automatically.
- If a programmed speed or speed limit is exceeded.

- If a warning message appears in the Driver Information Centre.
- If the electronic key is not in the passenger compartment.
- If the parking assist detects an object.
- If an unintended lane change occurs.
- If the exhaust filter has reached the maximum filling level.

When the vehicle is parked and / or the driver's door is opened

- With exterior lights on.

During an Autostop

- If the driver's door is opened.
- If any condition for an autostart is not fulfilled.

Vehicle personalisation

The vehicle's behaviour can be personalised by changing the settings in the Info Display.

Some functions are only displayed or active when the engine is running.

Graphic Info Display



Press **MENU** to open the menu page.

Use four-way button to operate the display:

Select  **Personalisation-configuration** \rightarrow OK.

Unit settings

Select **Display configuration** \rightarrow OK.

Select **Choice of units** \rightarrow OK.

Select desired settings \rightarrow OK.

Language settings

Select **Display configuration** \rightarrow OK.

Select **Choice of language** \rightarrow OK.

Select desired language \rightarrow OK.

Vehicle settings

Select **Define vehicle parameters** \rightarrow OK.

In the corresponding submenus the following settings can be changed:

- **Lighting.**

Follow me home headlamps:

Activation and setting duration time.

Welcome lighting: Activation and setting duration time.

- **Comfort**

Ambient lighting: Activation / Deactivation.

Rear wiper in reverse gear:

Activation / Deactivation.

- **Vehicle**
Unlocking boot only: Activation / Deactivation.
Plip action: Driver / all doors.
- **Driving assistance**
Fatigue Detection system: Activation / Deactivation.
Speed recommendation: Activation / Deactivation.

7" Colour Info Display



Press  to open homepage.

Use touch buttons to operate the display:

Select **Settings**.

Unit settings

Select Units

Change units for **Consumption and Distance** and **Temperature**.

Language settings

Select Language.

Change language by touching the respective entry.

Vehicle settings

Select Vehicle.

In the corresponding submenus the following settings can be changed:

- **Collision / Detection Systems**

Side Blind Spot Alert: Activates or deactivates side blind spot alert.

Drowsy Driver Alert: Activates or deactivates the driver drowsiness system.

Speed Limit Information: Activates or deactivates the speed limit information by traffic sign recognition.

Rear View Camera Guidelines: Activates or deactivates the rear

view camera guidelines on the Info Display.

- **Comfort and Convenience**
Auto Wipe in Reverse Gear: Activates or deactivates automatic switching on of the rear window wiper when reverse gear is engaged.

- **Lighting**

Ambient Lighting: Activates or deactivates the ambient lighting and adjusts its brightness.

Welcome Lighting: Activates or deactivates and changes the duration of welcome lighting.

Exit Lighting: Activates or deactivates and changes the duration of exit lighting.

- **Remote Lock, Unlock, Start**
Remote Door Unlock: Changes the configuration to unlock the driver's door only or all doors when pressing  on the remote control.

Unlock boot only: Activates or deactivates unlocking the tailgate

only when pressing  on the remote control.

8" Colour Info Display



Press **SET** to open settings menu.

Use touch buttons to operate the display.

Unit settings

Select **System settings**.

Change units for **Consumption and Distance** and **Temperature**.

Confirm with .

Language settings

Select **Languages**.

Change language by touching the respective entry.

Confirm with .

Vehicle settings



Press .

Select **Vehicle settings**.

In the corresponding submenus the following settings can be changed:

- **Headlights**

Welcome lighting: Activates or deactivates the function and adjusts its duration.

- **Guide-me-home lighting:**

Activates or deactivates the function and adjusts its duration.

- **Comfort**

Mood lighting: Adjusts the brightness of the ambient lighting.

Rear wiper in reverse: Activates or deactivates automatic switching on of the rear window wiper when reverse gear is engaged.

- **Vehicle access**

Door unlock: boot only: Activates or deactivates unlocking only the tailgate when pressing  on the remote control.

Door unlock: driver only:

Changes the configuration to unlock only the driver's door and fuel filler flap or all doors, load compartment and fuel filler flap when pressing  on the remote control.

- **Safety**

Driver attention warning:

Activates or deactivates the driver drowsiness system.

Driving functions



Press .

Select **Driving functions**.

In the corresponding submenus the following settings can be changed:

- **Park Assist:** Activates advanced park assist, a parking maneuver can be selected.
- **Blind Spot Sensors:** Activates or deactivates side blind spot alert.
- **Panoramic view system:** Activation / deactivation of the function.

Telematics services

Vauxhall Connect

Vauxhall Connect comprises multiple connected services accessible via app, online or within the vehicle.

Notice

Full functionality of

Vauxhall Connect is subject to registration and proper activation.

Connected services may include live navigation such as online traffic information and vehicle status and information such as maintenance alerts.

Services accessible within the vehicle also include emergency call and breakdown call. These functions are automatically activated. Terms and conditions apply.

Emergency call function and breakdown call function are operated by the buttons in the overhead console.

Status LED in the overhead console

Illuminates green and red and extinguishes after a short time, when the ignition is switched on: the system works properly.

Illuminates red: fault in the system. Contact a workshop.

Flashes red: backup battery needs replacement. Contact a workshop.

Emergency call

The emergency call function will establish a connection to the nearest public safety answering point (PSAP). A minimum set of data including vehicle and location information will be sent to the PSAP.

Notice

Establishing an emergency call may not be possible in areas without sufficient network availability or due to hardware damage during an accident.

In case of an emergency, press the red **SOS** button for more than 2 seconds. The LED flashes green to confirm that a connection to the nearest PSAP is being established. The LED illuminates steadily as long as the call is active.

Pressing the **SOS** button immediately a second time will terminate the call. The LED switches off.

Automatic crash notification

In case of an accident with airbag deployment, an automatic emergency call is established and an automatic crash notification will be transmitted to the next PSAP.

Breakdown call

Pressing the  button for more than 2 seconds connects you to a roadside assistance service provider.

For information about coverage and scope of services of the roadside assistance, please refer to the Service and warranty booklet.

Privacy settings

Privacy settings of Vauxhall Connect can be configured in your vehicle. This will impact the set of data being sent, e.g., in case a breakdown call is triggered. The emergency call function will not be impacted.

Change the privacy settings in the vehicle by simultaneously pressing the  button and the **SOS** button.

Versions with navigation system: privacy settings can also be changed in the system settings menu.

ERA GLONASS

ERA GLONASS is a manually or automatically actuated emergency service. Emergency centres provide assistance and information during an emergency.

In case of an accident with an impact of appropriate severity, an emergency call is placed automatically, regardless of airbag activation. An immediate connection with an advisor will be established who will check whether help is needed.

Danger

The service is only available for markets where it is legally required and activated. Furthermore, the manual and the automatic emergency call function depend on the availability of the emergency centres and the infrastructure in the country.

Notice

In order to be available and operational, the system requires functioning vehicle electrics, mobile service and GLONASS satellite link. Depending on equipment, a backup battery is used.

Control buttons



SOS button

In an emergency situation press and hold SOS button for more than 2 seconds. The green LED and the voice message will confirm that the call has been sent to the emergency centre.

The green LED illuminates when the service connection is established. It will go out when the connection is complete.

A minimum set of data is transferred to the emergency centre, including such data as car location, car model, vehicle identification number. The operator will contact you and, if necessary, send rescue workers from the relevant support services.

To cancel the call, press the SOS button again. The green LED goes out. The voice message confirms the cancellation.

Status LED

The system provides feedback via voice messages and an LED.

- Green : The system is activated. A connection to an operator is on duty.
- Red : The system is booting up after switching on ignition, the LED goes out after 3 seconds. If the LED stays red, a malfunction has been detected in the system. An emergency call may not work. Contact a workshop immediately.
- Red flashing : The internal backup battery is defective. Contact a workshop immediately.

Seek the assistance of a workshop if the LED does not illuminate after switching on the ignition.

Lighting

Exterior lighting	102
Light switch	102
Automatic light control	103
High beam	103
High beam assist	103
Headlight flash	104
Headlight range adjustment ...	104
Headlights when driving	
abroad	105
Daytime running lights	105
LED headlights	105
Hazard warning flashers	105
Turn lights	106
Front fog lights	106
Rear fog light	107
Parking lights	107
Reversing lights	107
Misted light covers	107
Interior lighting	108
Instrument panel illumination	
control	108
Interior lights	108
Reading lights	108
Sun visor lights	109

Lighting features	109
Centre console lighting	109
Entry lighting	109
Exit lighting	109
Battery discharge protection ...	110

Exterior lighting

Light switch



Turn light switch:

- AUTO** : automatic light control switches automatically between daytime running light and headlight
- ☞☞ : sidelights
- ☞☞☞ : headlights

Control indicator ☞☞ ⇨ 88.

Tail lights

Tail lights are illuminated together with low / high beam and sidelights.

Automatic light control



When the automatic light control function is switched on and the engine is running, the system switches between daytime running lights and headlights automatically depending on the external lighting conditions and information given by the wiper system.

Make sure the sensor is not blocked
 ⇨ 10, ⇨ 35.

Daytime running light ⇨ 105.

Automatic headlight activation

During poor lighting conditions headlights are switched on.

Additionally, headlights are switched on if the windscreen wipers have been activated for several wipes.
 LED headlights ⇨ 105.

Tunnel detection

When a tunnel is entered headlights are switched on immediately.

High beam

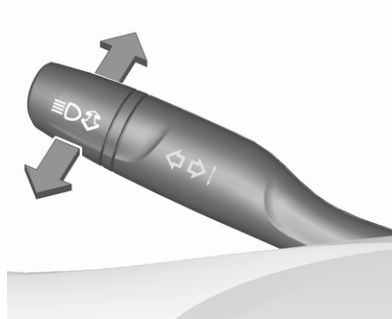

Push to switch from low to high beam.

Pull to deactivate high beam.

High beam assist ⇨ 103.

High beam assist

The camera in the windscreen detects the lights of oncoming or preceding vehicles. Once activated, high beam assist remains active and switches high beam on and off depending on surrounding conditions. The latest setting of the high beam assist will remain after the ignition is switched on again.

This feature automatically activates the high beam in the dark when vehicle speed is faster than 15 mph.

It switches automatically back to low beam when:

- The camera in the windscreen detects the lights of oncoming or preceding vehicles.
- The vehicle speed drops below 9 mph.
- It is foggy or snowy.
- Front or rear fog lights are switched on.
- Driving in urban areas.

If there are no restrictions detected, the system switches back to high beam.

Activation



Activate high beam assist by pressing . The LED of the button illuminates.

The green control indicator illuminates continuously when the high beam assist is activated, the blue one illuminates when high beam is on.

Control indicator ↻ 88, ↻ 88.

Deactivation

Deactivate high beam assist by pressing . The LED of the button extinguishes.

If a headlight flash is activated when the high beam assist is activated and low beam is on, the high beam assist will be deactivated. The system changes to high beam.

If a headlight flash is activated when the high beam assist is activated and high beam is on, the high beam assist will be deactivated. The system changes to low beam.

To reactivate the high beam assist, flash the headlights again.

Headlight flash



Pull to activate the headlight flash.

Pull to deactivate the high beam.

Headlight range adjustment

Manual headlight range adjustment

Headlight range can be adjusted manually if vehicle is equipped with halogen or Eco-LED headlights. Uplevel-LED headlights are adjusted automatically.

Dynamic automatic headlight levelling 105.



To adapt headlight range to the vehicle load to prevent dazzling: turn thumb wheel to required position.

- 0 : front seats occupied
- 1 : all seats occupied
- 2 : all seats occupied and load compartment laden
- 3 : driver's seat occupied and load compartment laden

Headlights when driving abroad

Versions with uplevel-LED: when driving in countries where traffic drives on the opposite side of the road, the headlights do not have to be adjusted.

All other versions: consult a workshop.

Daytime running lights

Daytime running lights increases visibility of the vehicle during daylight.

They are switched on automatically during daytime when engine is running.

The system switches between daytime running lights and low beam automatically, depending on the lighting conditions.

LED headlights

Eco-LED and uplevel-LED headlights for low and high beam ensure better visibility under all conditions. Uplevel LED headlights include the following functions:

- cornering lights
- high beam assist ↗ 103
- automatic headlight levelling

Cornering light

Light switch must be in position **AUTO**.



When turning off, depending on the steering angle and the turn light, particular LEDs are triggered which illuminate the direction of travel. It is activated up to a speed of 25 mph.

Reverse parking function

To assist driver's orientation when parking, both corner lights and reversing light illuminate when headlights are on and reverse gear is engaged. They remain illuminated for a short time after disengaging reverse gear or until driving faster than 4 mph in a forward gear.

Automatic headlight levelling

To prevent oncoming traffic from being dazzled, headlight levelling is automatically adjusted.

Fault in LED headlight system

When the system detects a failure in the LED headlight system, a warning is displayed in the Driver Information Centre.

Hazard warning flashers

Operated by pressing .



Hazard warning flashers are switched on automatically in the following situations:

- braking in an emergency (depending on the force of deceleration)
- in the event of an accident.

They are switched off by pressing  or accelerating.

Turn lights

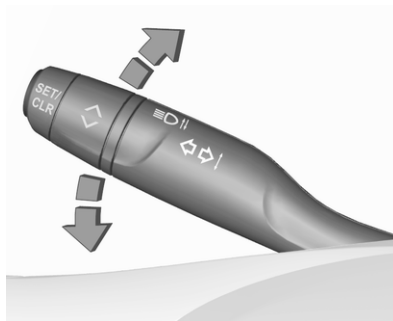

up : right turn light
down : left turn light

A resistance point can be felt when moving the lever.

Constant flashing is activated when the lever is being moved beyond the resistance point. It is deactivated when the steering wheel is moved in the opposite direction or lever is manually moved back to its neutral position.

After 20 seconds the volume of the audible signal will increase if the speed is above 40 mph.

Activate temporary flashing by holding the lever just before the resistance point. Turn lights will flash until lever is being released.

To activate three flashes, tap the lever briefly without passing the resistance point.

Front fog lights



Operated by pressing .

Light switch in position **AUTO**: switching on front fog lights will switch headlights on automatically.

Rear fog light



Operated by pressing .

Light switch in position **AUTO**: switching on rear fog light will switch headlights on automatically.

Light switch in position : rear fog light can only be switched on with front fog lights.

The vehicle rear fog light is deactivated when towing a trailer or a plug is connected with the socket, e.g. when a bicycle carrier is used.

Parking lights

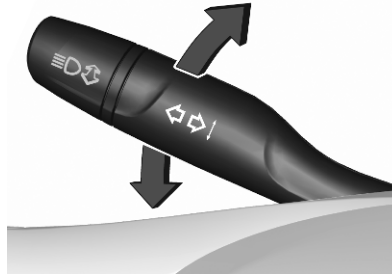

When the vehicle is parked, the parking lights on one side can be activated:

1. Switch off ignition.
2. Move the lever all the way up (right parking lights) or down (left parking lights).

Confirmed by a signal and the corresponding turn light control indicator.

Reversing lights

The reversing light comes on when the ignition is on and reverse gear is selected.

Misted light covers

The inside of the light housing may mist up briefly in poor, wet and cold weather conditions, in heavy rain or after washing. The mist disappears quickly by itself. To help, switch on the headlights.

Interior lighting

Instrument panel illumination control



Brightness of the following lights can be adjusted when headlights are switched on:

- instrument cluster illumination
- Info Display
- illuminated switches and operation elements

Turn thumb wheel  and hold until the desired brightness is obtained.

Interior lights



During entry and exit of the vehicle, the front and rear courtesy lights automatically switch on and then off after a delay.

Notice

In the event of an accident with airbag deployment the courtesy lights are turned on automatically.

Front courtesy light





-  : automatic switching on and off
- press  : on
- press  : off

Rear courtesy lights

Illuminate in conjunction with the front courtesy light.

Reading lights



Operated by pressing  and  in the courtesy lights.

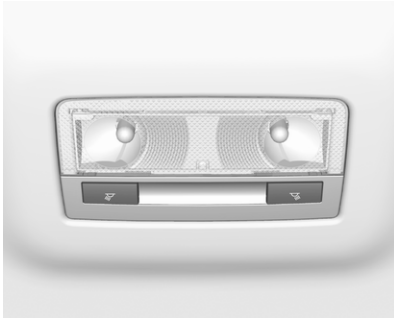

Illustration shows rear reading lights.

Sun visor lights

Illuminates when the cover is opened.

Lighting features

Centre console lighting

A spotlight integrated in the overhead console illuminates the centre console when headlights are switched on.

Entry lighting

Welcome lighting

Some or all of the following lights are switched on for a short time by unlocking the vehicle:

- headlights
- tail lights
- number plate lights
- centre console lighting
- interior lights

The number of activated lights depends on the surrounding light conditions.

The lighting switches off immediately when the ignition is switched on.

This function can be activated or deactivated in the vehicle personalisation.

Vehicle personalisation ↻ 96.

The following lights will additionally switch on when the driver's door is opened:

- illumination of some switches
- Driver Information Centre
- door pocket lights

Exit lighting

The following lights are switched on if the ignition is switched off:

- interior lights
- centre console lighting

They will switch off automatically after a delay. This function works only in the dark.

Battery discharge protection

Vehicle battery state of charge function

The function guarantees longest vehicle battery life via a generator with controllable power output and optimised power distribution.

To prevent discharge of the vehicle battery when driving, the following systems are reduced automatically in two stages and finally switched off:

- auxiliary heater
- heated rear window and heated mirrors
- heated seats
- fan

In the second stage, a message which confirms the activation of the vehicle battery discharge protection will be displayed in the Driver Information Centre.

Switching off interior lights

To prevent discharge of the vehicle battery when the ignition is switched off, some interior lights are switched off automatically after some time.

Climate control









Climate control systems	111
Heating and ventilation system	111
Air conditioning system	112
Electronic climate control system	115
Auxiliary heater	119
Air vents	120
Adjustable air vents	120
Fixed air vents	120
Maintenance	121
Air intake	121
Air conditioning regular operation	121
Service	121

Climate control systems

Heating and ventilation system



Controls for:

- temperature / \
- air distribution ,  and 
- fan speed 
- demisting and defrosting 
- heated rear window and heated exterior mirrors 
- heated windscreen 
- heated seats 

Temperature / \



Adjust the temperature by turning / \ to the desired temperature.

red area : warmer
blue area : colder

Heating will not be fully effective until the engine has reached normal operating temperature.

Air distribution

Press:

-  : to windscreen and front door windows
-  : to head area and rear seats via adjustable front air vents
-  : to front and rear foot well and windscreen



Combinations are possible.

Fan speed

Adjust the air flow by turning  to the desired speed.

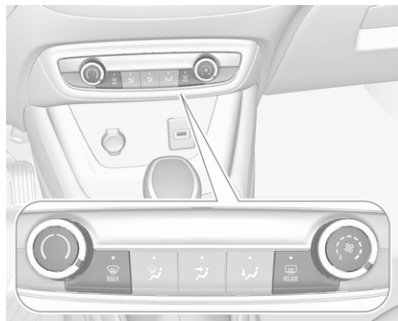
Demisting and defrosting the windows



- Press : the air distribution is directed towards the windscreen.
- Set temperature controller \nearrow \searrow to warmest level.
- Set fan speed  to highest level.
- Switch on heated rear window .
- Open side air vents as required and direct them towards the door windows.

Heated rear window  \rightarrow 37.

Heated exterior mirrors  \rightarrow 34.







Heated windscreen  \rightarrow 38.



Heated seats  \rightarrow 44.

Air conditioning system



Controls for:

- temperature \nearrow \searrow
- air distribution  and 
- fan speed 
- demisting and defrosting 
- air conditioning **A/C**
- air recirculation 
- heated rear window and heated exterior mirrors 

- heated windscreen 
- heated seats 



Some changes of settings are indicated briefly in the Info Display. Activated functions are indicated by the LED in the respective button.

Temperature \nearrow \searrow



Adjust the temperature by turning \nearrow \searrow to the desired temperature.

red area : warmer
blue area : colder

Heating will not be fully effective until the engine has reached normal operating temperature.

Air distribution

Press:

-  : to windscreen and front door windows
-  : to head area and rear seats via adjustable front air vents
-  : to front and rear foot well and windscreen

Combinations are possible.

Fan speed

Adjust the air flow by turning  to the desired speed.

Air conditioning A/C

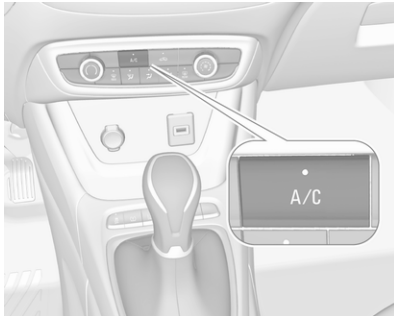

Press **A/C** to switch on cooling. Activation is indicated by the LED in the button. Cooling is only functional when the engine is running and climate control fan is switched on.

Press **A/C** again to switch off cooling.

The air conditioning system cools and dehumidifies (dries) as soon as the outside temperature is slightly above the freezing point. Therefore condensation may form and drip from under the vehicle.





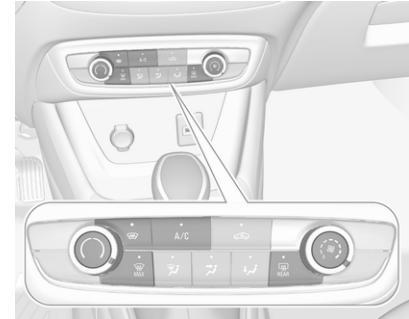

If no cooling or drying is required, switch off the cooling system for fuel saving reasons.

Activated cooling may inhibit Autostops.



Stop-start system  127.

Demisting and defrosting the windows



- Press : the air distribution is directed towards the windscreen.
- Set temperature controller   to warmest level.
- Switch on air conditioning **A/C** if required.
- Set fan speed  to highest level.
- Switch on heated rear window .
- Switch on heated windscreen .
- Open side air vents as required and direct them towards the door windows.

Notice

If  is pressed while the engine is running, an Autostop will be inhibited until  is pressed again.

If  is pressed while the engine is in an Autostop, the engine will restart automatically.

Stop-start system  127.

Air recirculation system 

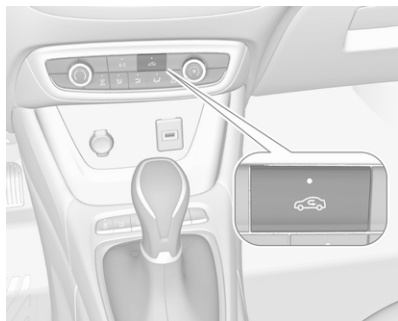

Press  to activate air recirculation mode, LED is indicated.

Select air recirculation to assist in cooling the interior or in blocking outside odours or exhaust.

Press  again to deactivate air recirculation mode.

 Warning





The exchange of fresh air is reduced in air recirculation mode. In operation without cooling, the air humidity increases, so the windows may mist up from inside. The quality of the passenger compartment air deteriorates, which may cause the occupants to feel drowsy.

In warm and very humid ambient air conditions, the windscreen may mist up from outside when cold air is directed towards it. If windscreen mists up from outside, activate windscreen wiper and deactivate .

Maximum cooling



Briefly open the windows so that hot air can disperse quickly.

- Switch on air conditioning **A/C**.
- Press  for air recirculation system on.
- Press  for air distribution.
- Set temperature control  \ to coldest level.
- Set fan speed  to highest level.
- Open all vents.

Heated rear window   37.

Heated exterior mirrors   34.

Heated windscreen   38.

Heated seats  ↗ 44.

Electronic climate control system



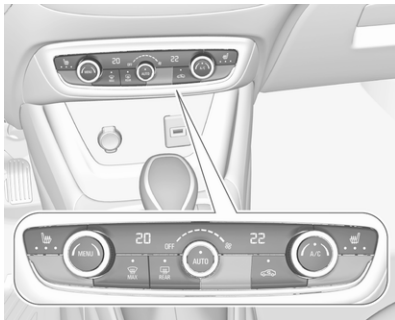

The dual zone climate control allows different temperatures for driver side and front passenger side.

In automatic mode, temperature, fan speed and air distribution are regulated automatically.



Controls for:

- temperature on driver side / \
- **MENU** enters the Climate setting menu in the Info Display
- fan speed 

- automatic mode **AUTO**
- temperature on front passenger side / \
- cooling **A/C**
- manual air recirculation 
- demisting and defrosting 
- heated rear window and heated exterior mirrors 
- heated windscreen 
- heated seats 

Activated functions are indicated by the LED in the respective control.

The electronic climate control system is only fully operational when the engine is running.

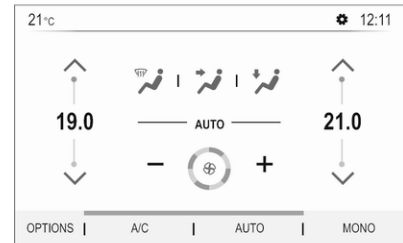

Make sure the sun sensor used by the electronic climate control system is not covered ↗ 10.

Climate settings menu





Press **MENU** to enter the climate setting menu.

Settings for:

- air distribution 
- fan speed 
- temperature for driver and passenger side
- dual zone temperature synchronisation **MONO**
- cooling **A/C**
- automatic mode **AUTO**

Climate setting menu can also be displayed

- by pressing  and then selecting **Climate** on the 7" Colour Info Display or
- by pressing  and then selecting **Climate** from the menu on the 8" Colour Info Display.

Automatic mode AUTO

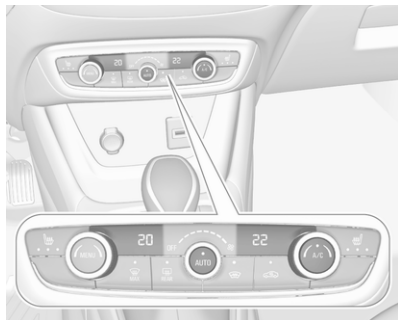

Basic settings for automatic control with maximum comfort:

- Press **AUTO** to start the cooling automatically.
- Open all air vents to allow optimised air distribution in automatic mode.
- Set the preselected temperatures for driver and front passenger using the left and right rotary knob. Recommended temperature is 22 °C. Temperature is indicated in displays beside the controls and in the climate settings menu.
- Air recirculation mode  should be deactivated. When deactivated the LED in the button is not illuminated.

Manual settings

Climate control system settings can be changed by activating the following functions:

Fan speed



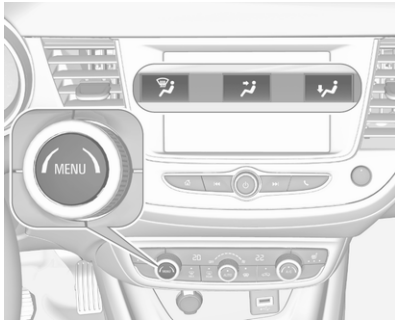

Adjust the air flow by turning rotary knob  to the desired speed.

To return to automatic mode, press **AUTO**.

Air distribution 

Press **MENU**.

Touch

-  : to windscreen and front door windows
-  : to head area and rear seats via adjustable air vents
-  : to front and rear foot well and windscreen

To return to automatic air distribution, press **AUTO**.

Temperature preselection / \

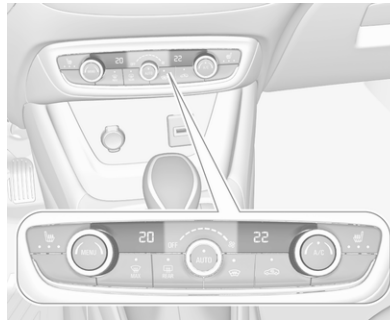

Set the preselected temperatures separately for driver and front passenger to the desired value using the left and right controls. The dial on the passenger side changes the temperature for the passenger side. The dial on the driver's side changes the temperature for the driver's side or for both sides depending on activation of synchronisation **MONO** in the climate settings menu. Press **MENU** to enter the menu.

Recommended temperature is 22 °C. Temperature is indicated in displays beside the controls and in the climate settings menu.

If the minimum temperature **Lo** is set, the climate control system runs at maximum cooling, if cooling **A/C** is switched on.

If the maximum temperature **Hi** is set, the climate control system runs at maximum heating.

Notice

If **A/C** is switched on, reducing the set cabin temperature can cause the engine to restart from an Autostop or inhibit an Autostop.

Stop-start system  127.

Dual zone temperature synchronisation MONO or SYNC

Press **MENU** to enter the menu. Touch **MONO** or **SYNC** to link passenger side temperature setting to the driver side.

When passenger side rotary knob will be adjusted, synchronisation is deactivated.

Cooling A/C

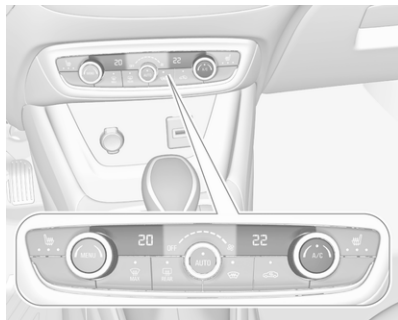

Press **A/C** to switch on cooling. The LED in the button illuminates to indicate activation. Cooling is only functional when the engine is running and climate control fan is switched on. Press **A/C** again to switch off cooling.

The air conditioning system cools and dehumidifies (dries) when outside temperature is above a specific level. Therefore condensation may form and drip from under the vehicle.

If no cooling or drying is required, switch off the cooling system for fuel saving reasons.

Manual air recirculation



Press  to activate the air recirculation mode. The LED in the button illuminates to indicate activation.

Press  again to deactivate recirculation mode.

Warning





The exchange of fresh air is reduced in air recirculation mode. In operation without cooling, the air humidity increases, so the windows may mist up from inside. The quality of the passenger

compartment air deteriorates, which may cause the occupants to feel drowsy.

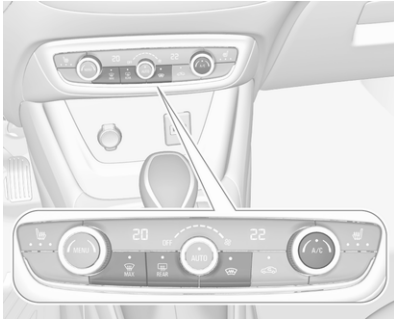

In warm and very humid ambient air conditions, the windscreen may mist up from outside, when cold air is directed towards it. If windscreen mists up from outside, activate windscreen wiper and deactivate .

Demisting and defrosting the windows



- Press . The LED in the button illuminates to indicate activation.
- Temperature and air distribution are set automatically and the fan runs at high speed.
- Switch on cooling by pressing **A/C**, if required.
- Switch on heated rear window .
- Switch on heated windscreen .
- To return to previous mode press  again, to return to automatic mode press **AUTO**.

Notice

If  is pressed while the engine is running, an Autostop will be inhibited until  is pressed again.

If  is pressed while the engine is in an Autostop, the engine will restart automatically.

Stop-start system ⇨ 127.

Deactivation of electronic climate control system

Cooling, fan and automatic mode can be switched off by turning rotary knob  anticlockwise.

Activation by switching on the fan or pressing **AUTO**.

Heated rear window  ⇨ 37.

Heated exterior mirrors  ⇨ 34.

Heated windscreen  ⇨ 38.

Heated seats  ⇨ 44.

Auxiliary heater

Air heater

Quickheat is an electric auxiliary air heater which automatically warms up the passenger compartment more quickly.

Air vents

Adjustable air vents

At least two air vents must be open while cooling is on.

⚠ Warning

Do not attach any objects to the slats of the air vents. Risk of damage and injury in case of an accident.

Air vents in the instrument panel



Direct the flow of air by tilting and swivelling the slats.

To close the vent, swivel the slats inwards.

Outer air vents in the instrument panel

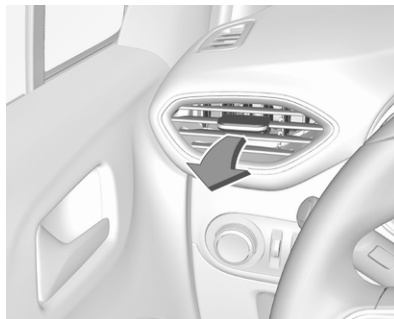

Direct the flow of air by tilting and swivelling the slats.

To close the vent, swivel the slats outwards.

Air vent on top of the instrument panel

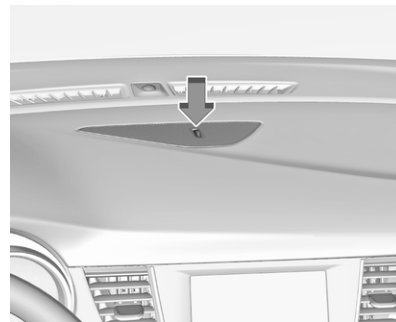

Close air flow by turning the thumb wheel to the front.

Fixed air vents

Additional air vents are located beneath the windscreen and door windows and in the foot wells.

Maintenance

Air intake

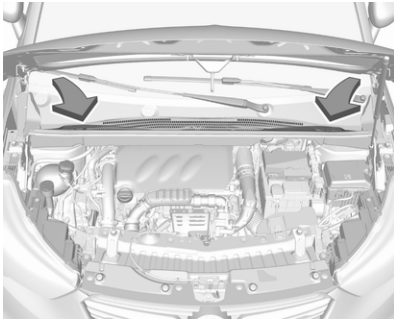

The air intake in front of the windscreen in the engine compartment must be kept clear to allow air intake. Remove any leaves, dirt or snow.

Cabin air filter

Change filter regularly for maximum effect.

More frequent passenger compartment air filter replacement may be needed, if you drive in areas with heavy traffic, poor air quality,

areas with high dust levels or which are sensitive to environmental allergens.

Passenger compartment air filter replacement may also be needed if there is reduced air flow, windows fogging up, or odors.

Your dealer can help to determine when it is the right time to replace the filter.

Air conditioning regular operation

In order to ensure continuously efficient performance, cooling must be operated for a few minutes once a month, irrespective of the weather and time of year. Operation with cooling is not possible when the outside temperature is too low.

Service

For optimal cooling performance, it is recommended to annually check the climate control system, starting 3 years after initial vehicle registration, including:

- functionality and pressure test
- heating functionality
- leakage check
- check of drive belts
- cleaning of condenser and evaporator drainage
- performance check
- cabin air filter check

Driving and operating

Driving hints	123
Control of the vehicle	123
Steering	123
Starting and operating	123
New vehicle running-in	123
Ignition switch positions	124
Power button	124
Starting the engine	125
Overrun cut-off	127
Stop-start system	127
Parking	129
Engine exhaust	130
Exhaust filter	130
Catalytic converter	131
AdBlue	131
Automatic transmission	134
Transmission display	134
Gear selection	134
Manual mode	135
Electronic driving programmes	136
Fault	136
Interruption of power supply	136
Manual transmission	137

Brakes	138
Antilock brake system	138
Parking brake	139
Brake assist	139
Hill start assist	139
Ride control systems	140
Electronic Stability Control and Traction Control system	140
Descent control system	141
Selective ride control	142
Driver assistance systems	144
Cruise control	144
Speed limiter	147
Forward collision alert	149
Active emergency braking	151
Front pedestrian protection	153
Parking assist	154
Advanced parking assist	157
Side blind spot alert	161
Panoramic view system	163
Rear view camera	166
Lane departure warning	167
Driver alert	168
Fuel	169
Fuel for petrol engines	169
Fuel for diesel engines	170
Refuelling	171
Trailer hitch	173
General information	173

Driving characteristics and towing tips	173
Trailer towing	173
Towing equipment	174

Driving hints

Control of the vehicle

Never coast with engine not running

Many systems will not function in this situation (e.g. brake servo unit, power steering). Driving in this manner is a danger to yourself and others.

All systems function during an Autostop.

Stop-start system ⇨ 127.

Pedals

To ensure the pedal travel is uninhibited, there must be no mats in the area of the pedals.

Use only floor mats, which fit properly and are fixed by the retainers on the driver side.

Steering

If power steering assist is lost because the engine stops or due to a system malfunction, the vehicle can be steered but may require increased effort.

Starting and operating

New vehicle running-in

Do not brake unnecessarily hard for the first few journeys.

During the first drive, smoke may occur because of wax and engine oil evaporating off the exhaust system. Park the vehicle in the open for a while after the first drive and avoid inhaling the fumes.

During the running-in period, fuel and engine oil consumption may be higher.

Additionally, the cleaning process of the exhaust filter may take place more often.

Exhaust filter ⇨ 130.

Ignition switch positions

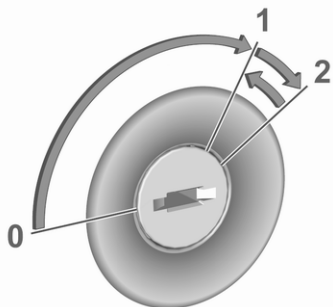

- 0 : ignition off: some functions remain active until key is removed or driver's door is opened, provided the ignition was on previously
- 1 : ignition on power mode: ignition is on, control indicators illuminate and most electrical functions are operable
- 2 : engine start: release key after engine has been started

Steering wheel lock

Remove key from ignition switch and turn steering wheel until it engages.

⚠ Danger

Never remove the key from ignition switch during driving as this will cause steering wheel lock.

Power button



The electronic key must be inside the vehicle.

Ignition on power mode without starting the engine

Press **Start/Stop** without operating a pedal. Control indicators illuminate and most electrical functions are operable.

Engine start

Operate the clutch pedal, the brake pedal and press **Start/Stop**. Release the button after starting procedure begins.

Engine and ignition off

Press **Start/Stop** briefly in each mode or when engine is running and vehicle is stationary. Some functions remain active until driver's door is opened, provided the ignition was on previously.

Emergency shut off during driving

If the engine needs to be switched off during driving in case of emergency, press **Start/Stop** for 5 seconds.

⚠ Danger

Switching off the engine during driving may cause loss of power support for brake and steering systems. Assistance systems and airbag systems are disabled. Lighting and brake lights will extinguish. Therefore power down

the engine and ignition while driving only when required in case of emergency.

Steering wheel lock

The steering wheel lock activates automatically when:

- The vehicle is stationary.
- The ignition has been switched off.

To release steering wheel lock, open and close driver's door and switch the ignition on power mode or start the engine directly.

⚠ Warning

If the vehicle battery is discharged, the vehicle must not be towed, tow-started or jump-started as the steering wheel lock cannot be disengaged.

Operation in case of failure

If either the electronic key fails or the battery of the electronic key is weak, the Driver Information Centre may

display **No Remote Detected** or **Replace Battery in Remote Key** when you try to start the vehicle.

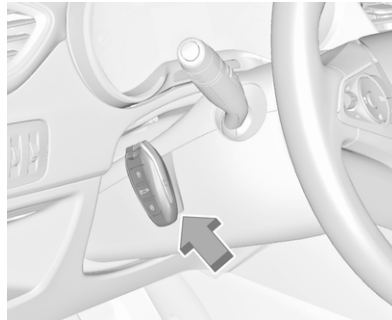

Hold the electronic key with buttons outside at the marking on the steering column cover as shown in the illustration.

Operate the clutch pedal, the brake pedal and press **Start/Stop**. Release the button after starting procedure begins.

This option is intended for emergencies only. Replace the electronic key battery as soon as possible ⇨ 22.

For unlocking or locking the doors, see fault in radio remote control unit or electronic key system ⇨ 23.

Starting the engine

Vehicles with ignition switch

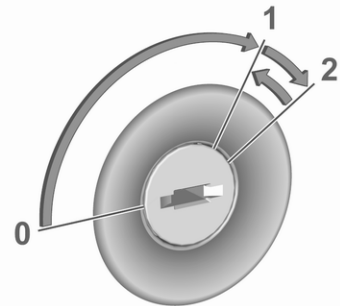

- Turn key to position 1.
- Move the steering wheel slightly to release the steering wheel lock.
- Manual transmission: operate clutch and brake pedal.
- Automatic transmission: operate brake pedal and move selector lever to **P** or **N**.

- Do not operate accelerator pedal.
- Diesel engines: wait until control indicator  extinguishes.
- Turn key to position 2 and release after the engine has been started.

Manual transmission: during an Autostop, the engine can be started by depressing the clutch pedal ↪ 127.

Automatic transmission: during an Autostop, the engine can be started by releasing the brake pedal ↪ 127.

Vehicles with power button



- Manual transmission: operate clutch and brake pedal.
- Automatic transmission: operate brake pedal and move selector lever to **P** or **N**.
- Do not operate accelerator pedal.
- Press **Start/Stop** button. Release button after starting procedure begins.
- Diesel engine starts after control indicator  for preheating extinguishes.
- Before restarting or to switch off the engine when vehicle is stationary, press **Start/Stop** once more briefly.

To start the engine during an Autostop:

- Manual transmission: during an Autostop, the engine can be started by depressing the clutch pedal ↪ 127.
- Automatic transmission: during an Autostop, the engine can be started by releasing the brake pedal ↪ 127.

Starting the vehicle at low temperatures

Starting the engine without additional heaters is possible down to -25 °C for diesel engines and -30 °C for petrol engines.

Required is an engine oil with the correct viscosity, the correct fuel, performed services and a sufficiently charged vehicle battery.

With temperatures below -30 °C the automatic transmission requires a warming phase of approx. 5 minutes. The selector lever must be in position **P**.

Turbo engine warm-up

Upon start-up, engine available torque may be limited for a short time, especially when the engine temperature is cold. The limitation is to allow the lubrication system to fully protect the engine.

Overrun cut-off

The fuel supply is automatically cut off during overrun, i.e. when the vehicle is driven with a gear engaged but accelerator pedal is released.



Depending on driving conditions, the overrun cut-off may be deactivated.

Stop-start system

The stop-start system helps to save fuel and to reduce the exhaust emissions. When conditions allow, it switches off the engine as soon as the vehicle is at a low speed or at a standstill, e.g. at a traffic light or in a traffic jam.

Activation

The stop-start system is available as soon as the engine is started, the vehicle starts-off and the conditions as stated below in this section are fulfilled.

The system is ready to operate when the LED in the button  is not illuminated. To activate the system when the system is deactivated, press .

If the stop-start system is temporarily not available and the button  is pressed, the LED in the button flashes.

Deactivation

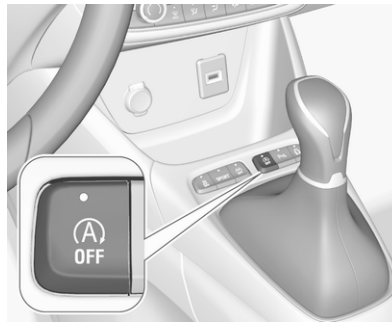

Deactivate the stop-start system manually by pressing . The deactivation is indicated when the LED in the button illuminates.

Autostop

Vehicles with manual transmission
An Autostop can be activated at a standstill.

Activate an Autostop as follows:

- Depress the clutch pedal.
- Set the lever to neutral.
- Release the clutch pedal.

The engine will be switched off while the ignition stays on.

Vehicles with automatic transmission

If the vehicle is at a standstill with depressed brake pedal, Autostop is activated automatically.

The engine will be switched off while the ignition stays on.

The stop-start system will be disabled on inclines of 12% or more.

Indication



An Autostop is indicated by control indicator .

During an Autostop, the heating and brake performance will be maintained.

Conditions for an Autostop

The stop-start system checks if each of the following conditions is fulfilled.

- The stop-start system is not manually deactivated.
- The driver's door is closed or the driver's seat belt is fastened.
- The vehicle battery is sufficiently charged and in good condition.
- The engine is warmed up.
- The engine coolant temperature is not too high.
- The engine exhaust temperature is not too high, e.g. after driving with high engine load.
- The ambient temperature is not too low or too high.
- The climate control system allows an Autostop.
- The brake vacuum is sufficient.

- The self-cleaning function of the exhaust filter is not active.
- The vehicle was driven at least at walking speed since the last Autostop.

Otherwise an Autostop will be inhibited.

Notice

The Autostop may be inhibited for several hours after a battery replacement or reconnection.

Certain settings of the climate control system may inhibit an Autostop. See Climate control chapter for more details ⇨ 112.

If an autostop is temporarily not available, (A) flashes green ⇨ 88.

Immediately after driving at a higher speed an Autostop may be inhibited.

Vehicle battery discharge protection

To ensure reliable engine restarts, several vehicle battery discharge protection features are implemented as part of the stop-start system.

Power saving measures

During an Autostop, several electrical features such as auxiliary electric heater or rear window heating are disabled or switched to a power saving mode. The fan speed of the climate control system is reduced to save power.

Restart of the engine by the driver

Vehicles with manual transmission

Depress the clutch pedal without depressing the brake pedal to restart the engine.

Vehicles with automatic transmission

The engine is restarted if

- the brake pedal is released while the selector lever is in position **D** or **M**
- or the brake pedal is released or the selector lever is in position **N** when the selector lever is moved to position **D** or **M**
- or the selector lever is moved to position **R**.

Restart of the engine by the stop-start system

The selector lever must be in neutral to enable an automatic restart.

If one of the following conditions occurs during an Autostop, the engine will be restarted automatically by the stop-start system:

- The stop-start system is manually deactivated.
- The driver's seat belt is unfastened or the driver's door is opened.
- The engine temperature is too low.
- The charging level of the vehicle battery is below a defined level.
- The brake vacuum is not sufficient.
- The climate control system requests an engine start.

If an electrical accessory, e.g. a portable CD player, is connected to the power outlet, a brief power drop during the restart might be noticeable.

Parking

⚠ Warning

- Do not park the vehicle on an easily ignitable surface. The high temperature of the exhaust system could ignite the surface.
- Always apply the parking brake. Activate the parking brake without pressing the release button. Apply as firmly as possible on a downhill slope or uphill slope. Depress brake pedal at the same time to reduce operating force.
- Switch off the engine.
- If the vehicle is on a level surface or uphill slope, engage first gear or set the selector lever to position **P**. On an uphill slope, turn the front wheels away from the kerb.

If the vehicle is on a downhill slope, engage reverse gear or set the selector lever to position

P. Turn the front wheels towards the kerb.

- Close the windows.
- Remove the ignition key from the ignition switch or switch off ignition on vehicles with power button. Turn the steering wheel until the steering wheel lock is felt to engage.

- Lock the vehicle with  on the radio remote control.

Or with electronic key system press marking on front door handles ⇨ 22.

- Activate the anti-theft alarm system ⇨ 31.
- The engine cooling fans may run after the engine has been switched off ⇨ 179.

Caution

After running at high engine speeds or with high engine loads, operate the engine briefly at a low load or run in neutral for

approx. 30 seconds before switching off, in order to protect the turbocharger.

Notice

In the event of an accident with airbag deployment, the engine is switched off automatically if the vehicle comes to a standstill within a certain time.

In countries with extremely low temperatures it may be necessary to park the vehicle without applied parking brake. Make sure to park the vehicle on a level surface.

Keys, locks ⇨ 20.

Laying-up the vehicle for a long period of time ⇨ 178.

Engine exhaust

Danger

Engine exhaust gases contain poisonous carbon monoxide, which is colourless and odourless and could be fatal if inhaled.



If exhaust gases enter the interior of the vehicle, open the windows. Have the cause of the fault rectified by a workshop.

Avoid driving with an open load compartment, otherwise exhaust gases could enter the vehicle.

Exhaust filter

Automatic cleaning process

The exhaust filter system filters soot particles out of the exhaust gases.



The start of saturation of the exhaust filter is indicated by the temporary illumination of  or , accompanied by a message in the Driver Information Centre.

As soon as the traffic conditions permit, regenerate the filter by driving at a vehicle speed of at least 40 mph until the control indicator extinguishes.

Notice

On a new vehicle, the first exhaust filter regeneration operations may be accompanied by a burning smell, which is normal. Following prolonged operation of the vehicle at very low speed or at idle, water vapour can be emitted at the exhaust on acceleration. This does not affect the behaviour of the vehicle or the environment.

Cleaning process not possible

If  or  stays on, accompanied by an audible signal and a message, this indicates that the exhaust filter additive level is too low.

The reservoir must be topped-up without delay. Seek the assistance of a workshop.

Catalytic converter

The catalytic converter reduces the amount of harmful substances in the exhaust gases.

Caution

Fuel grades other than those listed on pages ⇨ 169, ⇨ 228 could damage the catalytic converter or electronic components.

Unburnt fuel will overheat and damage the catalytic converter. Therefore avoid excessive use of the starter, running the fuel tank dry and starting the engine by pushing or towing.

In the event of misfiring, uneven engine running, a reduction in engine performance or other unusual problems, have the cause of the fault rectified by a workshop as soon as possible. In an emergency, driving can be continued for a short period, keeping vehicle speed and engine speed low.

AdBlue

General information

The selective catalytic reduction (BlueInjection) is a method to substantially reduce the nitrogen oxides in the exhaust emission. This is achieved by injecting a Diesel Exhaust Fluid (DEF) into the exhaust system. The ammonia released by the fluid reacts with nitrous gases (NO_x) from the exhaust and turns it into nitrogen and water.

The designation of this fluid is AdBlue®. It is a non-toxic, non-flammable, colourless and odourless fluid which consists of 32% urea and 68% water.

Warning

Avoid contact of your eyes or skin with AdBlue.

In case of eye or skin contact, rinse off with water.

Caution

Avoid contact of the paintwork with AdBlue.

In case of contact, rinse off with water.

AdBlue freezes at a temperature of approx. $-11\text{ }^{\circ}\text{C}$. As the vehicle is equipped with an AdBlue preheater, the emissions reduction at low temperatures is ensured. The AdBlue preheater works automatically.

Notice

Frozen and again liquefied AdBlue is usable without quality loss.

Level warnings

The AdBlue consumption is approx. 1.5 l per 600 miles. The consumption can be higher depending on driving behaviour (e.g. high load or towing).

Depending on the calculated range of AdBlue, different messages are displayed in the Driver Information Centre. The messages and the restrictions are a legal requirement.

The first possible warning message appears at an AdBlue range below 1500 miles, shows up at each start and each 190 miles range reduction:

Top up AdBlue: Starting impossible in 1500 mi

Additionally, control indicator  illuminates continuously and a chime sounds with every message pop-up.

At an AdBlue range below 380 miles, the following warning message is being displayed, shows up at each start and each 12 miles range reduction:

Top up AdBlue: Starting impossible in 380 mi

Additionally, control indicator  flashes continuously and a chime sounds with every message pop-up.

Notice

In case of high AdBlue consumption, the Driver Information Centre may display this warning without the previous warning stages.

The last warning level is entered when the AdBlue tank is empty. Restart of the engine is not possible.

The following warning message is being displayed and cannot be dismissed:

Top up AdBlue: Starting impossible

Additionally, control indicator  flashes continuously and engine cannot be restarted until AdBlue tank is being filled with at least 5 l.

High emission warnings

If the exhaust emission rises above a certain value, warnings similar to the range warnings will be displayed in the Driver Information Centre.

Requests to have the exhaust system checked and finally the announcement of the prevention of an engine restart are displayed. These restrictions are a legal requirement.

Consult a workshop for assistance.

Refilling AdBlue

Caution

Only use AdBlue that complies with European standards DIN 70 070 and ISO 22241-1.

Do not use additives.

Do not dilute AdBlue.

Otherwise the selective catalytic reduction system could be damaged.

Notice

Whenever a filling pump with a nozzle for passenger cars is not available at a filling station, use only AdBlue bottles or canisters with a sealed refill adapter for refilling, to prevent splashback and overspill, and in order to ensure that the fumes from the tank are captured and do not emerge. AdBlue in bottles or canisters is available in many filling

stations and can be purchased e.g. at Vauxhall dealers and other retail outlets.

Since AdBlue has a limited durability, check the date of expiry before refilling.

Notice

Refill the tank to a level of at least 5 l to ensure that the new AdBlue level is being detected.

In case AdBlue refill is not successfully detected:

1. Continuously drive the vehicle for 10 min making sure that vehicle speed is always higher than 12 mph.
2. If AdBlue refill is detected successfully, AdBlue supply-driven warnings or limitations will disappear.

If AdBlue refill is still not detected, seek the assistance of a workshop.

If AdBlue must be refilled at temperatures below -11°C , the refilling of AdBlue may not be detected by the system. In this

event, park the vehicle in a space with a higher ambient temperature until AdBlue is liquified.

Notice

When unscrewing the protective cap from the filler neck, ammonia fumes may emerge. Do not inhale as the fumes have a pungent smell. The fumes are not harmful by inhalation.

It is recommended to fill the AdBlue tank completely.

The vehicle must be parked on a level surface.

The filler neck for AdBlue is located behind the fuel filler flap, which is located at left rear side of the vehicle.

The fuel filler flap can only be opened if the vehicle is unlocked.

1. Switch off ignition.
2. Close all doors to avoid ammonia fumes entering the interior of the vehicle.
3. Release the fuel filler flap by pushing the flap ↗ 171.

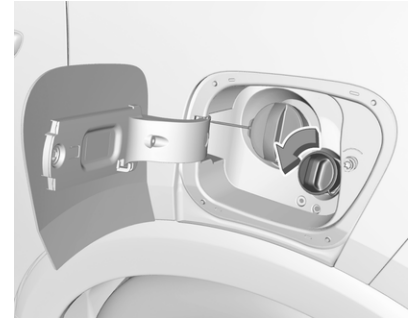

4. Unscrew protective cap from the filler neck.
5. Open AdBlue canister.
6. Mount one end of the hose on the canister and screw the other end on the filler neck.
7. Lift the canister until it is empty, or until the flow from the canister has stopped. This can take up to 5 minutes.
8. Place the canister on the ground to empty the hose, wait 15 seconds.

9. Unscrew the hose from the filler neck.
10. Mount the protective cap and turn clockwise until it engages.

Notice

Dispose of AdBlue canister according to environmental requirements. Hose can be reused after flushing with clear water before AdBlue dries out.

Automatic transmission

The automatic transmission permits automatic gearshifting (automatic mode) or manual gearshifting (manual mode).

Manual shifting is possible in manual mode by tapping the selector lever to + or - ▷ 135.

Transmission display



The mode or selected gear is shown in the Driver Information Centre.

D and the number of the engaged gear indicates automatic mode.

M and the number of the selected gear indicates manual mode.

R indicates reverse gear.

N indicates neutral position.

P indicates park position.

Gear selection

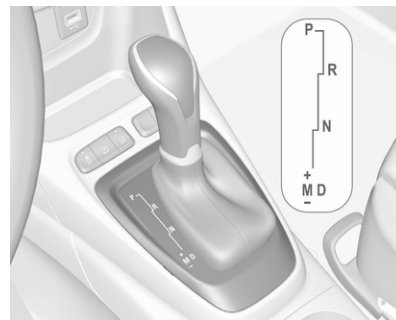

Move the selector lever in the shifting gate as shown in the illustration above.

- P** : park position, wheels are locked, engage only when the vehicle is stationary and the parking brake is applied
- R** : reverse gear, engage only when the vehicle is stationary
- N** : neutral
- D** : automatic mode
- M** : manual mode
- +** : upshift in manual mode
- : downshift in manual mode

The selector lever is locked in **P** and can only be moved when the ignition is on and the brake pedal is applied.

The engine can only be started with the lever in position **P** or **N**. When position **N** is selected, press the brake pedal or apply the parking brake before starting.

Do not accelerate while engaging a gear. Never depress the accelerator pedal and brake pedal at the same time.

When a gear is engaged, the vehicle slowly begins to creep when the brake is released.

Engine braking

To utilise the engine braking effect, select a lower gear in good time when driving downhill, see manual mode.

Rocking the vehicle

Rocking the vehicle is only permissible if the vehicle is stuck in sand, mud or snow. Move the selector lever between **D** and **R** in a repeat pattern. Do not race the engine and avoid sudden acceleration.

Parking

Apply the parking brake and engage **P**.

Manual mode

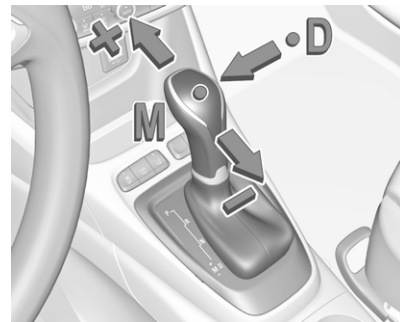

Move selector lever out of position **D** towards the left in position **M**.

Tap selector lever towards **+** to shift to a higher gear.

Tap the selector lever towards **-** to shift to a lower gear.

If a higher gear is selected when vehicle speed is too low, or a lower gear when vehicle speed is too high, the shift is not executed. This can cause a message in the Driver Information Centre.

In manual mode, no automatic shifting to a higher gear takes place at high engine revolutions.

Gear shifting ⇨ 85.

Electronic driving programmes

- Following a cold start, the operating temperature programme increases engine speed to quickly bring the catalytic converter to the required temperature.
- Special programmes automatically adapt the shifting points when driving up inclines or down hills.
- In snowy or icy conditions or on other slippery surfaces, the electronic transmission control enables the driver to select manually first, second or third gear for starting off.

Kickdown

Pressing down the accelerator pedal beyond the kickdown detent will lead to maximum acceleration independent of selected driving mode. The transmission shifts to a lower gear depending on engine speed.

Fault

In the event of a fault a message is displayed in the Driver Information Centre.

Vehicle messages ⇨ 95.

Electronic transmission control enables only third gear. The transmission no longer shifts automatically.

Do not drive faster than 62 mph.

Have the cause of the fault remedied by a workshop.

Interruption of power supply

In the event of an interruption of power supply, the selector lever cannot be moved out of the **P** position.

If the vehicle battery is discharged, start the vehicle using jump leads ⇨ 211.

If the vehicle battery is not the cause of the fault, release the selector lever.

1. Apply the parking brake.
2. Release the selector lever trim from the centre console. Poke with a finger into the leather socket below the selector lever and push the trim upwards.

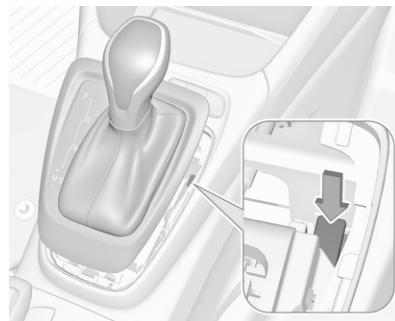

3. Push down the button and move the selector lever out of **P**. Have the cause of the power supply interruption remedied by a workshop.
4. Mount the selector lever trim onto the centre console and refit.

Manual transmission

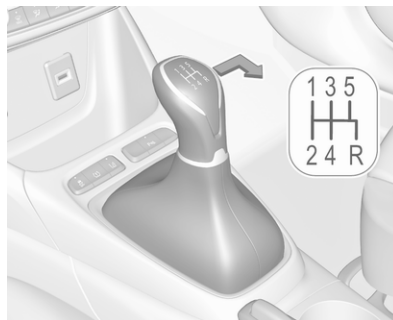

To engage reverse on 5-speed transmission, depress the clutch pedal and move the selector lever to the right and rear.

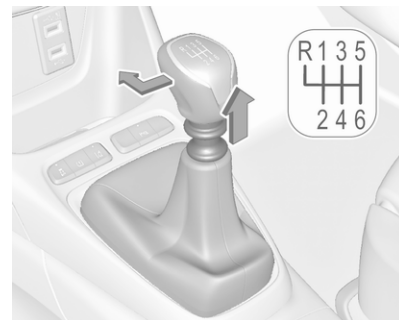

To engage reverse on 6-speed transmission, depress the clutch pedal, pull the ring under the selector lever and move the selector lever quite to the left and front.

If the gear does not engage, set the lever to neutral, release the clutch pedal and depress again; then repeat gear selection.

Do not slip the clutch unnecessarily.

When operating, depress the clutch pedal completely. Do not use the pedal as a foot rest.

When clutch slip is detected for a specific time, the engine power will be reduced. A warning is displayed in the Driver Information Centre. Release the clutch.

Caution

It is not advisable to drive with the hand resting on the selector lever.

Gear shifting ⇨ 85.

Stop-start system ⇨ 127.

Brakes

The brake system comprises two independent brake circuits.

If a brake circuit fails, the vehicle can still be braked using the other brake circuit. However, braking effect is achieved only when the brake pedal is depressed firmly. Considerably more force is needed for this. The braking distance is extended. Seek the assistance of a workshop before continuing the journey.

When the engine is not running, the support of the brake servo unit disappears once the brake pedal has been depressed once or twice. Braking effect is not reduced, but braking requires significantly greater force. It is especially important to bear this in mind when being towed.

Control indicator (Ⓢ) ⇨ 85.

Antilock brake system

Antilock brake system (ABS) prevents the wheels from locking.

ABS starts to regulate brake pressure as soon as a wheel shows a tendency to lock. The vehicle remains steerable, even during hard braking.

ABS control is made apparent through a pulse in the brake pedal and the noise of the regulation process.

For optimum braking, keep the brake pedal fully depressed throughout the braking process, despite the fact that the pedal is pulsating. Do not reduce the pressure on the pedal.

When braking in an emergency, the hazard warning flashers are switched on automatically depending on the force of deceleration. They are switched off automatically the first time you accelerate.

After starting off, the system performs a self-test which may be audible.



Control indicator (Ⓢ) ⇨ 85.

Fault

⚠ Warning

If there is a fault in the ABS, the wheels may be liable to lock due to braking that is heavier than normal. The advantages of ABS are no longer available. During hard braking, the vehicle can no longer be steered and may swerve.

Have the cause of the fault remedied by a workshop.

Parking brake

⚠ Warning

Before leaving the vehicle, check parking brake status. Control indicator (P) illuminate constantly when electric parking brake is applied.

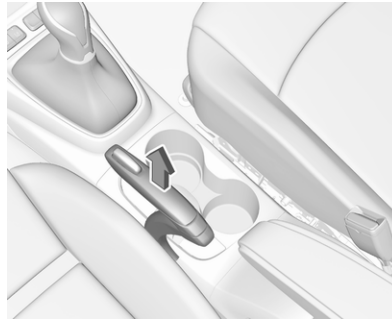

⚠ Warning

Always apply parking brake firmly without operating the release button, and apply as firmly as possible on a downhill or uphill slope.

To release the parking brake, pull the lever up slightly, press the release button and fully lower the lever.

To reduce the operating forces of the parking brake, depress the foot brake at the same time.

Control indicator (P) ⇨ 85.

Brake assist

If brake pedal is depressed quickly and forcefully, maximum brake force is automatically applied.

Operation of brake assist might become apparent by a pulse in the brake pedal and a greater resistance when depressing the brake pedal.

Maintain steady pressure on the brake pedal as long as full braking is required. Maximum brake force is automatically reduced when brake pedal is released.

Hill start assist

The system helps prevent unintended movement when driving away on inclines.

When releasing the brake pedal after stopping on an incline, brakes remain on for further 2 seconds. The brakes release automatically as soon as the vehicle begins to accelerate.

Ride control systems

Electronic Stability Control and Traction Control system

Electronic stability control (ESC) improves driving stability when necessary, regardless of the type of road surface or tyre grip.

As soon as the vehicle starts to swerve (understeer / oversteer), engine output is reduced and the wheels are braked individually.

ESC operates in combination with the traction control system. It prevents the driven wheels from spinning.

The traction control system is a component of the ESC and prevents the driven wheels from spinning. As soon as the driven wheels starts to spin, engine output is reduced and the wheel spinning the most is braked individually. This considerably improves the driving stability of the vehicle on slippery road surfaces.



ESC and traction control system are operational after each engine start as soon as the control indicator  extinguishes.

When ESC and traction control system operate,  flashes.

Warning

Do not let this special safety feature tempt you into taking risks when driving.

Adapt speed to the road conditions.

Control indicator  ⇨ 86.

Deactivation

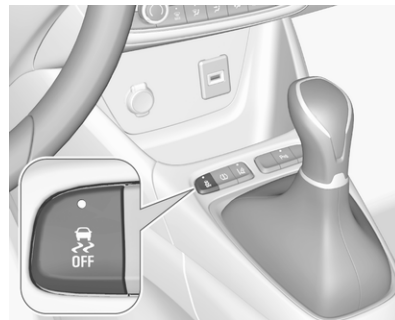

ESC and traction control system can be deactivated, everytime it is required: press .

Control indicator  illuminates ⇨ 86.

A status message appears in the Driver Information Centre.

ESC and traction control system are reactivated by pressing the  button again, by applying the brake or in the case that the vehicle is driven faster than 30 mph.

 extinguishes when ESC and traction control system are reactivated.

ESC and traction control system are also reactivated the next time the ignition is switched on.

Fault

If there is a fault in the system, the control indicator  illuminates continuously and a message appears in the Driver Information Centre. The system is not operational.

Have the cause of the fault remedied by a workshop.

Descent control system

The descent control system allows the vehicle to travel at a low speed without depressing the brake pedal. The vehicle will automatically decelerate to a low speed and remain at that speed when the system is activated. Some noise or vibration from the brake system may be apparent when the system is active.

Caution

Use only when descending steep grades while driving off-road. Do not use when driving on normal road surfaces. Unnecessary usage of the DCS function, such as while driving on normal roads, may damage the brake system and the ESC function.



Activation

Notice

If hill descent control is active, active emergency braking is automatically deactivated.

The systems is only available for slopes greater than 5%.





At speeds below approx. 30 mph, press . The system can also be activated when the vehicle is stationary with the engine running. The control indicator  in the instrument cluster is illuminated in green to show the system is activated.



When the vehicles starts its descent, the system controls the speed of the vehicle; accelerator and brake pedals can be released.

- If the gearbox is in first or second gear, the speed decreases and the control indicator in the instrument cluster flashes rapidly.
- If the gearbox is in neutral or the clutch pedal is released, the speed decreases and the control indicator in the instrument cluster flashes slowly.

If the system is operating, the brake lights automatically come on.

If the speed exceeds 18 mph, regulation is paused. The  indicator light in the instrument cluster changes to grey. However, the LED of the  button is still illuminated. Regulation is automatically resumed if the speed falls below 18 mph, the slope is greater than 5% and the pedal release conditions are met.

Deactivation

Press  again until the LED in the button extinguishes. The green control indicator  in the instrument cluster extinguishes, too.

Depressing the foot brake or accelerator will also cause the system to be deactivated.

If the speed exceeds 43 mph, the system is automatically deactivated. The LED in the button extinguishes.

Fault

If the green control indicator  does not illuminate or flash after pressing the button, there is a fault in the system.

Seek the assistance of a workshop.

Selective ride control

Caution

The vehicle is designed to drive principally on-road, but it also enables driving off-road occasionally.

However, do not drive on terrain where the vehicle could be damaged due to obstacles, such

as stones among others and on terrain with steep inclines and poor grip.

Do not cross waters.

Caution





When driving off-road, sudden motion and manoeuvres can cause a collision or losing control.

Selective ride control is designed to optimise traction in low-grip conditions (snow, mud and sand).

It adapts to the terrain by acting on the front wheels, in doing so this saves the weight normally associated with a more conventional four wheel drive system.



Selective ride control allows to choose between five driving modes:

- ESC off mode 
- standard mode 
- snow mode 
- mud mode 
- sand mode 

The several modes can be activated by turning the control.

A LED illuminates and a status message appears in the Driver Information Centre to confirm the chosen mode.

ESC off mode

The ESC and Traction Control are deactivated in this mode.

A LED in the button  illuminates.

ESC and Traction Control are reactivated automatically from 30 mph or everytime the ignition is switched on.

Standard mode

This mode is calibrated for a low level of wheel spin, based on the different types of grip generally encountered in normal day to day driving.

Everytime the ignition is switched off, the system is automatically reset to this mode.

Snow mode

This mode adapts to the grip conditions encountered by each wheel when starting.

When advancing, the system optimises wheel spin to guarantee the best acceleration based on the

available traction. Recommended in cases of deep snow and steep inclines.

This mode is active up to a speed of 30 mph.

Mud mode

This mode allows considerable wheel spin at start-up for the wheel with the least grip, this removes mud and re-establishes traction.

Simultaneously, the wheel with the most grip is provided with the most torque possible.

This mode is active up to a speed of 50 mph.

Sand mode

This mode allows a small amount of simultaneous wheel spin on the two drive wheels, enabling the vehicle to advance and reduce the risk of sinking.

This mode is active up to a speed of 75 mph.

Caution

Do not use the other modes on sand as the vehicle may become stuck.

Driver assistance systems

⚠ Warning

Driver assistance systems are developed to support the driver and not to replace the driver's attention.

The driver stays in full control of the vehicle and accepts full responsibility when driving the vehicle.

When using driver assistance systems, always take care regarding the current traffic situation and follow applicable traffic rules.

Cruise control

The cruise control can store and maintain speeds above 25 mph.

Additionally at least the third gear must be engaged on manual transmission.

Additionally position **D** or the second or a higher gear in position **M** must be selected on automatic transmission.

Deviations from the stored speeds may occur when driving uphill or downhill.

The system maintains the vehicle speed at the preset speed by the driver, without any action on the accelerator pedal.

The preset speed can be exceeded temporarily by pressing the accelerator pedal firmly.



The status and preset speed is displayed in the Driver Information Centre.

Do not use the cruise control if it is not advisable to maintain a constant speed.

Control indicator   88.

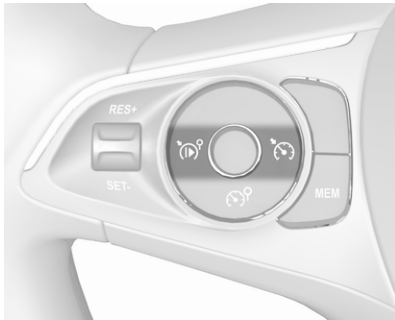
Switching on the system



Press  on the steering wheel: symbol  and a message are indicated in the Driver Information Centre. The system is still not active.

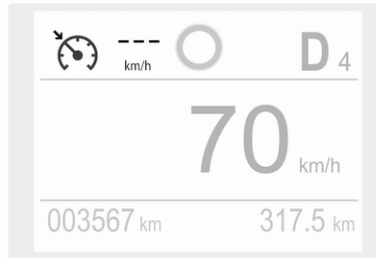

Activation of the functionality

Setting speed by the driver

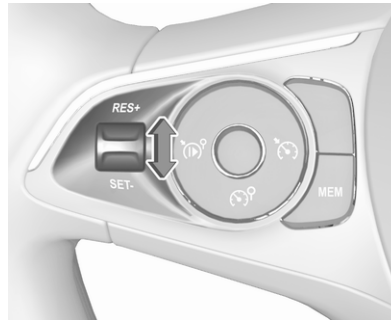

Accelerate to the desired speed and move thumb wheel briefly to **SET/-**. The current speed is stored and maintained. Accelerator pedal can be released.

The preset speed can then be changed by moving thumb wheel to **RES/+** to increase or to **SET/-** to decrease the speed. Move thumb wheel repeatedly to change speed in small steps, move and hold to change speed in large steps.

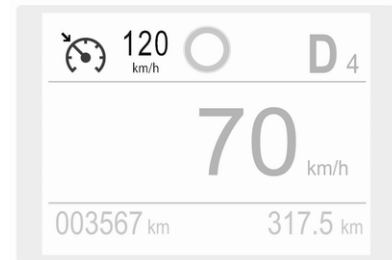

Speed value is indicated in the Driver Information Centre.

Adopting speed by the speed limit recognition

The intelligent speed adaptation informs the driver when a speed limit is detected by the speed limit recognition. The detected speed limit can be used as new value for the cruise control.

Using the camera at the top of the windscreen, this system detects and reads speed limit and end of speed limit signs.

If the cruise control is active:

- in the uplevel Driver Information Centre the recognised speed limit will be displayed and **MEM** illuminates.
- in the midlevel Driver Information Centre the recognised speed limit will be displayed on the digital speed indication page along with an instruction message.

Press **MEM** on the steering wheel to request saving of the suggested speed.

Press **MEM** on the steering wheel once more to confirm and save the new speed setting.

This speed is the new value for the cruise control.

This function can be deactivated or activated in the personalisation menu ↗ 96.

Exceeding the set speed

Vehicle speed can be increased by depressing the accelerator pedal.

When the accelerator pedal is released, the previously stored speed is resumed.

Deactivation of the functionality

Press : cruise control is in pause mode and a message is displayed. The vehicle is driven without cruise control.

Cruise control is deactivated, but not switched off. Last stored speed remains in memory for later speed resume.

Cruise control is deactivated automatically when:

- The brake pedal is depressed.
- Vehicle speed is below 25 mph.
- The Traction Control system or Electronic Stability Control is operating.
- The manual transmission is in **N**, first or second gear.
- The automatic transmission is in position **M** and first gear.

Resume stored speed

Move thumb wheel to **RES/+** at a speed above 25 mph. The stored speed will be obtained.

Switching off the system

Press : the cruise control mode is deselected and the cruise control indication extinguishes in the Driver Information Centre.

Pressing  to activate the speed limiter deactivates cruise control.

Switching off the ignition cancels any programmed speed value.

Fault

In the event of a cruise control fault, the speed is cleared resulting in flashing of the dashes.

The speed limiter may not operate correctly if traffic signs do not comply with the Vienna Convention on Road Signs and Signals.

Speed limiter

The speed limiter prevents the vehicle from exceeding a preset maximum speed.

The maximum speed can be set at speeds above 18 mph.



The driver can accelerate the vehicle up to the preset speed. Deviations from the limited speed may occur when driving downhill.

The preset speed can be exceeded temporarily by pressing the accelerator pedal fully.

The status and preset speed limit is displayed in the Driver Information Centre.

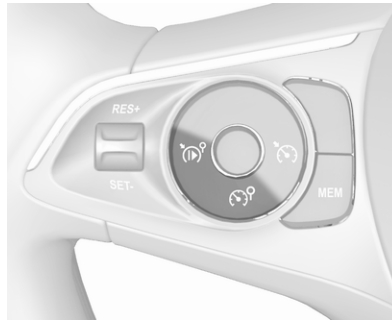
Switching on the system



Press , symbol  and a message are displayed in the Driver Information Centre. The system is still not active.

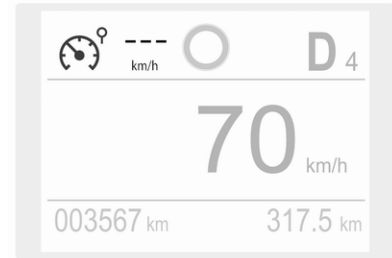

Activation of the functionality

Setting speed by the driver

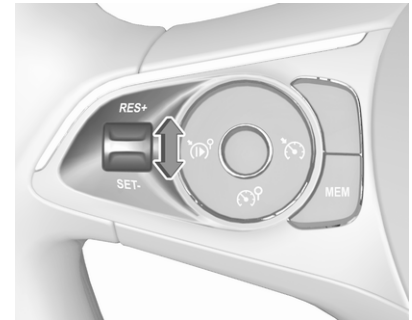

Accelerate to the desired speed and move thumb wheel briefly to **SET/-**. The current speed is stored as maximum speed.

The preset maximum speed can be changed by moving thumb wheel to **RES/+** to increase or to **SET/-** to decrease the desired maximum speed. Move thumb wheel repeatedly to change speed in small steps, move and hold to change speed in large steps.



Speed value is indicated in the Driver Information Centre.

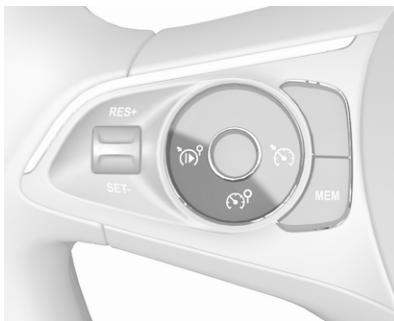

Press  to activate speed limiter.

Adopting speed by the speed limit recognition

The intelligent speed adaptation informs the driver when a speed limit is detected by the speed limit recognition. The detected speed limit can be used as new value for the speed limiter.

Using the camera at the top of the windscreen, this system detects and reads speed limit and end of speed limit signs.

If the speed limiter is active:

- in the uplevel Driver Information Centre the recognised speed limit will be displayed and **MEM** illuminates.
- in the midlevel Driver Information Centre the recognised speed limit will be displayed on the digital speed indication page along with an instruction message.

Press **MEM** on the steering wheel to request saving of the suggested speed limit.

Press **MEM** on the steering wheel once more to confirm and save the new speed setting.

This speed is the new value for the speed limiter.

This function can be deactivated or activated in the personalisation menu  96.

Exceeding the speed limit

In the event of an emergency, it is possible to exceed the speed limit by depressing the accelerator pedal fully. In this case the preset speed value flashes.

Release the accelerator pedal and the speed limiter function is reactivated once a speed lower than the speed limit is obtained.

Deactivation of the functionality

Press , speed limiter is in pause mode and a message is displayed. The vehicle is driven without speed limiter.

Speed limiter is deactivated, but not switched off. Last stored speed remains in memory for later speed resume.

Resume limit speed

Press . The stored speed limit will be obtained.

Switching off the system

Press , the speed limiter mode is deselected and the speed limit indication extinguishes in the Driver Information Centre.

Pressing  to activate cruise control deactivates speed limiter.

The preset speed remains in the memory when the ignition is switched off.

Fault

In the event of a speed limiter fault, the speed is cleared resulting in flashing of the dashes.

The speed limit recognition may not operate correctly if traffic signs do not comply with the Vienna Convention on Road Signs and Signals.

Forward collision alert

The forward collision alert may help to avoid or reduce the harm caused by front-end crashes.

The forward collision alert uses the front camera in the windscreen to detect a preceding vehicle directly ahead, in your path.

If a vehicle directly ahead is approached too quickly, a warning chime and alert in the Driver Information Centre is provided.

Warning

Forward collision alert is just a warning system and does not apply the brakes. When approaching a vehicle ahead too rapidly, it may not provide you enough time to avoid a collision.

The driver accepts full responsibility for the appropriate following distance based on traffic, weather and visibility conditions.



The complete attention of the driver is always required while driving. The driver must always be ready to take action and apply the brakes.

Activation

Forward collision alert detects vehicles and operates automatically at all speeds above 3 mph and 53 mph. The system detects stationary vehicles if the speed does not exceed 50 mph.

Alerting the driver

The driver is warned by following alerts:

- Symbol  illuminates and a warning message is displayed in the Driver Information Centre when the distance to the vehicle ahead gets to small.
- Symbol  illuminates, a warning message is displayed in the Driver Information Centre and a warning chime sounds, when a collision is imminent and immediate driver's action is required.

Warning

Forward collision alert is just a warning system and does not apply the brakes. When approaching a vehicle ahead too rapidly, it may not provide you enough time to avoid a collision.

The driver accepts full responsibility for the appropriate following distance based on traffic, weather and visibility conditions.

The complete attention of the driver is always required while driving. The driver must always be ready to take action and apply the brakes.

Caution

The colour lighting of this control indicator does not correspond to local traffic laws on following distance. The driver bears full responsibility for maintaining safe following distance according to

applicable traffic rules, weather and road conditions etc. at all times.

Selecting the alert sensitivity

The alert sensitivity has to be set to close, normal or distant in the vehicle personalisation menu ⇨ 96.

The chosen setting will remain until it is changed. The alert timing will vary based on vehicle speed. The faster the vehicle speed, the farther away the alert will occur. Consider traffic and weather conditions when selecting the alert timing.

Deactivation

The system can only be deactivated by deactivating the active emergency braking in the vehicle personalisation ⇨ 96.

System limitations

Forward collision alert is designed to warn on vehicles only, but may react also to other objects.

In the following cases, forward collision alert may not detect a vehicle ahead or sensor performance is limited:

- driving on winding or hilly roads
- driving in the dark
- weather limits visibility, such as fog, rain, or snow
- the sensor in the windscreen is blocked by snow, ice, slush, mud, dirt etc.
- the windscreen is damaged or affected by foreign objects, e.g. stickers

Active emergency braking

Active emergency braking can help to reduce the damage and injury from crashes with vehicles, pedestrians and obstacles directly ahead, when a collision can no longer be avoided either by manual braking or by steering. Before the active emergency braking applies, the driver is warned by the forward collision alert or the front pedestrian protection alert.

Forward collision alert ⇨ 149.

Front pedestrian protection ⇨ 153.

The feature uses various inputs (e.g. camera sensor, brake pressure, vehicle speed) to calculate the probability of a frontal collision.

Warning

This system is not intended to replace the driver responsibility for driving the vehicle and looking ahead. Its function is limited to supplemental use only to reduce the vehicle speed before a collision.

The system may not react to animals. After a sudden lane change, the system needs a certain time to detect the next preceding vehicle.

The driver must always be ready to take action and apply the brakes and steer to avoid collisions.

Functionality

Active emergency braking is equipped with a front camera and operates in forward gear in the range between walking speed and 53 mph. The system detects stationary vehicles only if the speed does not exceed 50 mph.

A precondition is that forward collision alert with front camera system is not deactivated in the vehicle personalisation menu ⇨ 96.

The system includes:

- emergency automatic braking
- forward looking brake assist
- forward collision alert
- front pedestrian protection

Emergency automatic braking

After activation of brake preparation system and just before the imminent collision, this function automatically applies limited braking to reduce the impact speed of the collision or prohibit a crash. If active emergency braking is applied,  flashes in the instrument cluster. Depending on the

situation, the vehicle may automatically brake moderately or hard. This front automatic braking can only occur if a vehicle or a pedestrian ahead is detected.

Forward collision alert ⇨ 149.

Front pedestrian protection ⇨ 153.

Emergency automatic braking may slow the vehicle to a complete stop to try to avoid a potential crash.

⚠ Warning

Emergency automatic braking is an emergency crash preparation feature and is not designed to avoid crashes. Do not rely on the system to brake the vehicle. Emergency automatic braking will not brake outside of its operating speed range and only responds to detected vehicles and pedestrians.

Forward looking brake assist

In addition to emergency automatic braking, the forward looking brake assist function makes the brake assist

more sensitive. Therefore, pressing the brake pedal less strongly results in immediate hard braking. This function helps the driver brake quicker and harder before the imminent collision.

⚠ Warning

Active emergency braking is not designed to apply hard autonomous braking or to automatically avoid a collision. It is designed to reduce the vehicle speed before a collision. It may not react to animals. After a sudden lane change, the system needs a certain time to detect the next preceding vehicle.

The complete attention of the driver is always required while driving. The driver must always be ready to take action and apply the brakes and steer to avoid collisions.

The system is designed to work with all occupants wearing their seat belts.

Forward collision alert ⇨ 149.

Front pedestrian protection ⇨ 153.

System limitations

In some cases, the active emergency braking system may provide an automatic braking in situations that seem to be unnecessary, for instance in parking garages, due to traffic signs in a curve or due to vehicles in another lane. This is normal operation, the vehicle does not need service. Firmly apply the accelerator pedal to override the automatic braking if the situation and the surroundings permit.

In the following cases, active emergency braking performance is limited:

- driving on winding or hilly roads
- detecting all vehicles, especially vehicles with a trailer, tractors, muddy vehicles, etc.
- detecting a vehicle when weather limits visibility, such as in fog, rain, or snow
- driving in the dark
- windscreen damaged or stickered

Complete attention is always required while driving, and you should be ready to take action and apply the brakes and / or steer the vehicle to avoid crashes.

We recommend to deactivate the system in the vehicle personalisation in the following cases:

- when towing a trailer or caravan
- when carrying long objects on roof bars or a roof rack
- when the vehicle is being towed with the engine running
- when a spare wheel is fitted that is smaller than the other wheels
- before using an automatic car wash with the engine running
- before placing the vehicle on a rolling road in a workshop
- if the windscreen has been damaged close to the camera
- if the front bumper has been damaged
- if the brake lights are not working

Active emergency braking can be deactivated in the personalisation menu ↪ 96. If deactivated, 

illuminates in the instrument cluster and a warning message is displayed in the Driver Information Centre.

Fault

In case the system requires a service, a message is displayed in the Driver Information Centre.

If the system does not work as it should do, vehicle messages are displayed in the Driver Information Centre.

Vehicle messages ↪ 95.

Front pedestrian protection

Front pedestrian protection may help to avoid or reduce the harm caused by front-end crashes with pedestrians when driving forward.

The system uses the front camera in the windscreen to detect a pedestrian directly ahead in your path.

Front pedestrian protection can detect and alert to pedestrians in a forward gear at speeds between 3 mph and 37 mph.

During driving in the dark, system performance is limited.

Danger

Front pedestrian braking does not provide an alert or automatically brake the vehicle, unless it detects a pedestrian.

The system may not detect pedestrians, including children, when the pedestrian is not directly ahead, not fully visible, not standing upright, or when part of a group.

Front pedestrian protection includes:

- detecting front pedestrian ahead
- front pedestrian alert

Front pedestrian protection is activated together with forward collision alert.

Forward collision alert ↪ 149.

Detecting front pedestrian ahead

A pedestrian ahead up to a distance of approx. 40 m is indicated by a symbol in the instrument cluster.

Front pedestrian alert

When approaching a detected pedestrian too quickly, a warning message is displayed in the Driver Information Centre. A warning chime is provided.

Cruise control or Adaptive cruise control may be disengaged when the front pedestrian alert occurs.

System limitations

In the following cases, front pedestrian protection may not detect a pedestrian ahead or sensor performance is limited:

- vehicle speed is out of range from 3 mph to 37 mph in forward gear
- the distance to an pedestrian ahead is more than 40 m
- driving on winding or hilly roads
- driving in the dark
- weather limits visibility, such as fog, rain, or snow

- the sensor in the windscreen is blocked by snow, ice, slush, mud, dirt etc.
- the windscreen is damaged or affected by foreign objects, e.g. stickers

Parking assist

General information

The system is switched off automatically when attaching a trailer or bike carrier to the trailer hitch.

⚠ Warning

The driver bears full responsibility for the parking manoeuvre.

Always check the surrounding area when driving backwards or forwards while using parking assist system.

The parking assist makes parking easier by measuring the distance between the vehicle and obstacles. It informs and warns the driver by giving acoustic signals and display indication.

Acoustic signals are given on the side on which the vehicle is closer to an obstacle. The interval between the sounds becomes shorter as the vehicle gets closer to that obstacle. When the distance is less than approx. 30 cm, the sound is continuous.

Rear parking assist

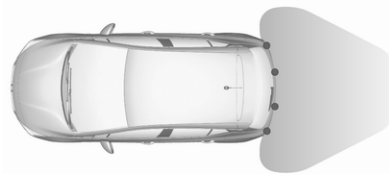

The system operates with ultrasonic parking sensors in the rear bumper.

Activation



Rear parking assist is activated when reverse gear is engaged.

The system is ready to operate when the LED in the parking assist button  is not illuminated.

Indication

The system warns the driver with acoustic signals against potentially hazardous obstacles behind the vehicle in a distance range up to 50 cm.



Additionally, the distance to rear obstacles is displayed by changing distance lines in the Info Display  92. When the obstacle is very close,  for danger is displayed in the screen.

Deactivation

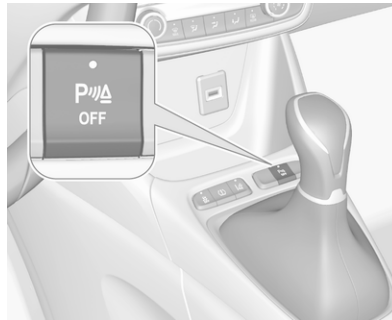

The system is switched off when reverse gear is disengaged. Press  to deactivate the system manually. The LED in the button illuminates when the system is deactivated. If the system has been deactivated manually, it is not reactivated automatically the next time the ignition is switched on.

Front-rear parking assist

It uses two different acoustic warning signals for the front and rear monitoring areas, each with a different tone frequency.

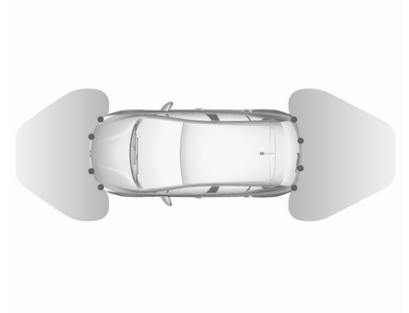

The system operates with ultrasonic parking sensors in the rear and front bumper.

Activation

Rear parking assist is activated when reverse gear is engaged.

In addition to the rear parking assist, the front parking assist is triggered when an obstacle is detected in front and the speed of the vehicle is still below 6 mph.

The system is ready to operate when the LED in the parking assist button  is not illuminated.

Indication

The system warns the driver with acoustic signals against potentially hazardous obstacles in front of the vehicle and behind the vehicle by using the respective loudspeakers.



Additionally, the distance to rear and front obstacles is displayed by changing distance lines in the Info Display ↗ 92.

Deactivation

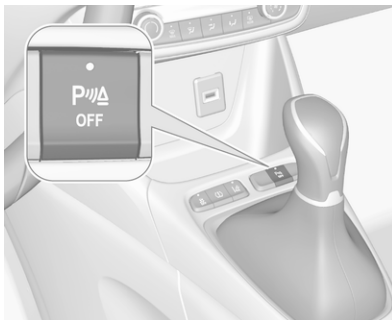

The system is deactivated automatically when vehicle speed exceeds 6 mph or if the vehicle stops for more than 3 seconds in a forward gear or if no further obstacles are detected.

When the system is deactivated manually, the LED in the button illuminates.

If the system has been deactivated manually, it is not reactivated automatically the next time the ignition is switched on.

System limitations

In the event of a fault or if the system does not work temporarily, e.g. because of high external noise level or other interference factors, **Service** in the cluster instrument illuminates. A message is indicated in the Driver Information Centre.

Warning

Under certain circumstances, various reflective surfaces on objects or clothing as well as external noise sources may cause the system to fail to detect obstacles.

Special attention must be paid to low obstacles which can damage the lower part of the bumper.

Caution

Performance of the system can be reduced when sensors are covered, e.g. by ice or snow.

Performance of the parking assist system can be reduced due to heavy loading.

Special conditions apply if there are taller vehicles in the vicinity (e.g. off-road vehicles, mini vans, vans). Object identification and correct distance indication in the upper part of these vehicles cannot be guaranteed.

Objects with a very small reflection cross-section, e.g. objects of narrow size or soft materials, may not be detected by the system.

Parking assist systems do not detect objects outside the detection range.

Notice

Make sure that the front number plate is properly mounted (not bent and no gaps to the bumper on the left or right side) and the sensors are

firmly in place. The performance of the parking assist could be reduced if the number plate is bent or a number plate holder is used.

Advanced parking assist

⚠ Warning

The driver bears full responsibility for accepting the parking slot suggested by the system and the parking manoeuvre.

Always check the surrounding area in all directions when using the advanced parking assist.

The advanced parking assist measures a suitable parking slot while passing, calculates the trajectory and automatically steers the vehicle while parking.

Advanced parking assist provides assistance for the following manoeuvres:

- entry into a parallel parking slot
- entry into a perpendicular parking slot
- exit from a parallel parking slot

The driver must control acceleration, braking and gear shifting, while steering is done automatically. The driver can take control at any time by gripping the steering wheel.

It may be necessary to move forwards and backwards more than once.

Instructions are given in the Info Display ↗ 92.

Advanced parking assist can only be activated when driving forwards.

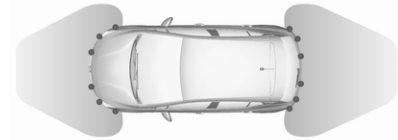

Advanced parking assist is always combined with front-rear parking assist.

The system has six ultrasonic parking sensors each in both the rear and front bumper.

Entry into a parallel parking slot

Activation

7" Colour Info Display: to search for a parking slot, activate the system by selecting **Park Assist** on the homepage of the touch screen. Then select **Enter parallel parking space**.

8" Colour Info Display: to search for a parking slot, activate the system by pressing . Select Driving functions on the touch screen and then **Park Assist**. Select **Enter parallel parking space**.

 illuminates in the instrument cluster to confirm the function.

Slow down the vehicle speed below 12 mph.

Select parking side by switching on turn light indicator on the respective side.

The allowed parallel distance between the vehicle and a row of parked cars is between 0.5 m and 1.5 m.

The system will not identify slots that are clearly smaller or larger than the vehicle.

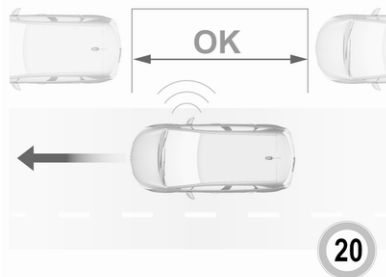

When a free slot is detected, a visual feedback on the Colour Info Display and a first acoustic signal is given. Drive slowly forwards. When the second acoustic signal is given, stop the vehicle, select reverse gear, release the steering wheel and start moving without exceeding 4 mph.

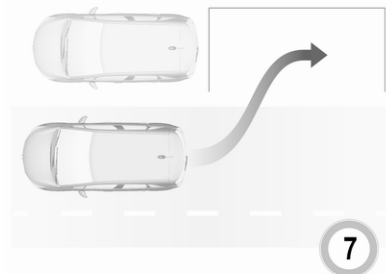



Move forwards and backwards while observing the warnings of the parking assist until the end of manoeuvre is indicated. When finished,  extinguishes in the instrument cluster.

Entry into a perpendicular parking slot

Activation

7" Colour Info Display: to search for a parking slot, activate the system by selecting **Park Assist** on the homepage of the touch screen. Then select **Enter perpendicular parking space**.

8" Colour Info Display: when search for a parking slot, activate the system by pressing . Select Driving functions on the touch screen and then **Park Assist**. Select **Enter bay parking space**.

 illuminates in the instrument cluster to confirm the function.

Slow down the vehicle speed below 12 mph.

Select parking side by switching on turn light indicator on the respective side.

The allowed parallel distance between the vehicle and a row of parked cars is between 0.5 m and 1.5 m.

When several successive slots are found, the vehicle will be directed towards the last one.

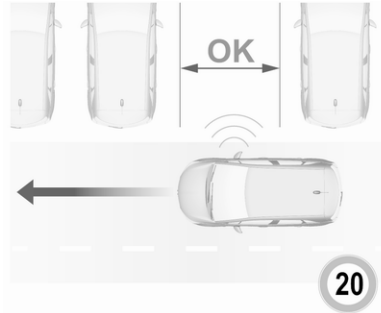

When a free slot is detected, a visual feedback on the Colour Info Display and an acoustic signal is given. Stop the vehicle, select reverse gear, release the steering wheel and start moving without exceeding 4 mph.

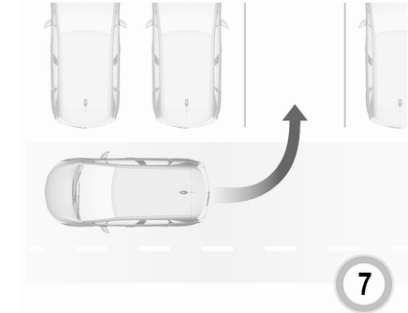

Move forwards and backwards as instructed by observing the warnings of the parking assist and paying attention to the acoustic signals until the end of manoeuvre is indicated. When finished,  extinguishes in the instrument cluster.

During the parking manoeuvre, the system is automatically deactivated once the rear of the vehicle is within 50 cm of an obstacle.

Exiting a parallel parking slot

Activation

7" Colour Info Display: when exiting a parallel parking slot, activate the system by selecting **Park Assist** on the homepage of the touch screen. Then select **Exit parallel parking space**.

8" Colour Info Display: when exiting a parallel parking slot, activate the system by pressing . Select Driving functions on the touch screen and then **Park Assist**. Select **Exit parallel parking space**.

Select exit side by switching on the respective turn light indicator.

Engage reverse or forward gear, release the steering wheel and start moving without exceeding 3 mph.

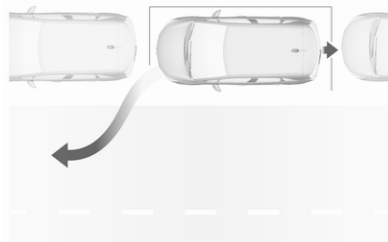

Move forwards and backwards while observing the warnings of the parking assist until the end of manoeuvre is indicated. The manoeuvre is complete when the vehicle's front wheels are out of the parking slot and  extinguishes in the instrument cluster.

After deactivation check control over the vehicle.

Display indication

The instructions on the display show:

- general hints and warning messages
- the demand to stop the vehicle, when a parking slot is detected
- the direction of driving during the parking manoeuvre
- the demand to shift into reverse or first gear
- the demand to stop or to drive slowly
- the successful completion of the parking manoeuvre indicated by a pop-up symbol and a chime
- the cancelling of a parking manoeuvre

Deactivation

The current park assist manoeuvre is cancelled via the button to return to the previous screen in the Colour Info Display. To deactivate the system completely, press **P  Off** in the centre console.

The system is deactivated automatically:

- if the ignition is switched off
- if stalling the engine
- if no manoeuvre is started within 5 minutes of selection of the type of manoeuvre
- after a prolonged stop of the vehicle during a manoeuvre
- if the electronic stability control is triggered
- if the speed of the vehicle exceeds the stated limit
- when the driver interrupts movement of the steering wheel
- after four manoeuvre cycles
- on opening the driver's door
- if one of the front wheels encounters an obstacle
- parking manoeuvre successfully ended

Deactivation by the driver or by the system during manoeuvring will be indicated on the display. Additionally, an acoustic signal sounds.

The system is switched off automatically when attaching a trailer or bike carrier to the trailer hitch.

Contact your dealer to switch off the system for a prolonged period.

Fault

In the event of a fault, P_0 flashes for a few seconds, accompanied by an acoustic signal. If the fault occurs during the use of the system, P_0 extinguishes.

In the event of a fault in the power steering, $\ominus!$ flashes in the instrument panel, accompanied by a message.

Notice

It is possible that the sensor detects a non-existing object caused by echo disturbance from external acoustic noise or mechanical misalignments (sporadic false warnings may occur).

Advanced parking assist system may not respond to changes in the available parking space after initiating a parking manoeuvre. The system may recognise an entry, a gateway, a courtyard or even a

crossing as a parking slot. After selecting reverse gear the system will start a parking manoeuvre. Take care regarding the availability of the suggested parking slot.

Low curbs and surface irregularities, e.g. on construction zones, are not detected by the system. The driver accepts responsibility.

Side blind spot alert

The side blind spot alert system detects and reports objects on either side of the vehicle, within a specified blind spot zone. The system displays a visual alert in each exterior mirror, when detecting objects that may not be visible in the interior and exterior mirrors.

Side blind spot alert uses some of the parking assist sensors.

Warning

Side blind spot alert does not replace driver vision.

The system does not detect:

- vehicles outside the side blind zones which may be rapidly approaching
- pedestrians, cyclists or animals

Before changing a lane, always check all mirrors, look over the shoulder and use the turn light.

Activation

7" Colour Info Display: select **Blind spot monitoring** on the Info Display and activate the function.

8" Colour Info Display: press . Select Driving functions on the Info Display and then **Blind spot monitoring**. Activate the function.

 illuminates continuously green in the instrument cluster to confirm the function.

Functionality

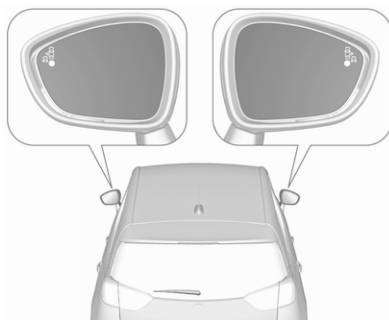

When the system detects a vehicle in the side blind zone while driving forwards, an LED will illuminate in the relevant exterior mirror.

The LED comes on immediately when being passed.

The LED comes on after a delay when passing another vehicle slowly.

Operation conditions

The following conditions must be fulfilled for proper operation:

- all vehicles are moving in the same direction and in adjacent lanes
- the vehicle speed is between 7 and 87 mph
- passing a vehicle with a speed difference of less than 6 mph
- another vehicle is passing with a speed difference of less than 15 mph
- the traffic flow is normal
- driving on a straight or slightly curved road

No alert will be given in the following situations:

- in the presence of non-moving objects, e.g. parked vehicles, barriers, street lamps, road signs
- in very dense traffic, when moving vehicles might be confused with a stationary object
- with vehicles moving in the opposite direction

- driving on a winding road or a sharp corner
- when passing or being passed by a very long vehicle, e.g. lorry, coach, which is at the same time detected at the rear in the blind spot angle and present in the driver's forward field of vision
- when passing too quickly

Deactivation



The system is deactivated in the vehicle personalisation ↻ 96.  extinguishes in the instrument cluster. Additionally, an acoustic signal sounds.

The state of the system is stored when switching off the ignition.

The system is switched off automatically when attaching a trailer or bike carrier to the trailer hitch.

Due to adverse weather conditions such as heavy rain, false detections may occur.

Fault

In the event of a fault,  flashes for a few moments in the instrument cluster, accompanied by  and a display message. Seek the assistance of a workshop.

Panoramic view system

This system allows views of the vehicle's surroundings to be displayed as a nearly 180° picture in the Info Display, like a bird's eye view.

The system uses:

- rear camera, installed in the tailgate
- ultrasonic parking sensors in the rear bumper

The screen is divided into two parts: on the right there is a view from above the vehicle, and on the left there are different views displayed.

Activation

Panoramic view system is activated by:

- engaging reverse gear
- driving up to 6 mph

Functionality

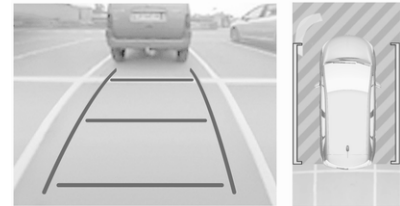

Different views can be selected in the left part of the display. Change the type of view by pressing the touch field in the left lower zone of the display:

- rear view
- auto mode

- zoom view
- 180° view

Auto mode is activated by default. In this mode, the system selects the best view, standard or zoom, to display according to the information from the parking sensors.

The state of the system is not kept in memory when the ignition is switched off.

Rear view



The area behind the vehicle is displayed in the screen. The vertical lines represent the width of the

vehicle with mirrors unfolded. The direction of the lines changes with the steering angle.

The horizontal lines represent a distance of about 30 cm, 1m and 2 m beyond the rear bumper.

This view is available in auto mode or in the view selection menu.

Auto mode

This mode is activated by default. Using sensors in the rear bumper, the automatic view changes from a rear view to a view from above, as an obstacle is approached during a manoeuvre.

Zoom view



The camera records the vehicle's surroundings during the manoeuvre in order to reconstruct a view from above the rear of the vehicle in its near surroundings, allowing the vehicle to be manoeuvred around obstacles nearby. This view is available with auto mode or in the view selection menu.

180° view

The 180° view facilitates reversing out of a parking bay, making it possible to see the approach of vehicles, pedestrians and cyclists. This view is not recommended for carrying out a complete manoeuvre. It is made up of three areas: left 1, centre 2 and right 3. This view is available from the view selection menu only.

Deactivation

Panoramic view system is deactivated when:

- driving faster than 6 mph
- 7 seconds after disengaging reverse gear
- by pressing the icon \otimes in the left upper corner of the touch screen
- opening the tailgate

General information**⚠ Warning**

The panoramic view system does not replace driver vision. It will not display children, pedestrians, cyclists, crossing traffic, animals, or any other objects outside of the camera view area, e. g. below the bumper, or underneath the vehicle.

Do not drive or park the vehicle using only the panoramic view system.

Always check the surrounding of the vehicle before driving.

Displayed images may be further or closer than they appear. The area displayed is limited and objects that are close to either edge of the bumper or under the bumper are not displayed on the screen.

System limitations**Caution**

For optimal operation of the system, it is important to keep the lense of the camera in the tailgate between the number plate lights always clean. Rinse the lense with water and wipe with a soft cloth.

Do not clean the lense with a steam-jet or high-pressure jet cleaner.

The panoramic view system may not operate properly when:

- The surrounding is dark.
- The sun or the beam of headlights is shining directly into the camera lenses.

- During nighttime driving.
- Weather limits visibility, such as fog, rain, or snow.
- The camera lenses are blocked by snow, ice, slush, mud, dirt.
- A trailer or bike carrier is attached to the trailer hitch.
- The vehicle had an accident.
- There are extreme temperature changes.

Rear view camera

The rear view camera assists the driver when reversing by displaying a view of the area behind the vehicle.

The view of the camera is displayed in the Info Display.

⚠ Warning

The rear view camera does not replace driver vision. Note that objects that are outside the camera's field of view and the parking assist sensors, e.g. below the bumper or underneath the vehicle, are not displayed.

Do not reverse or park the vehicle using only the rear view camera. Always check the surrounding of the vehicle before driving.

Switching on

Rear view camera is automatically activated when reverse gear is engaged.

Functionality

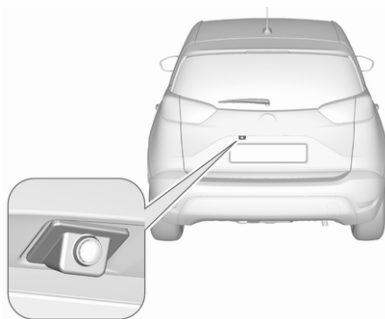

The area displayed by the camera is limited. The distance of the image that appears on the display differs from the actual distance.

Guidelines

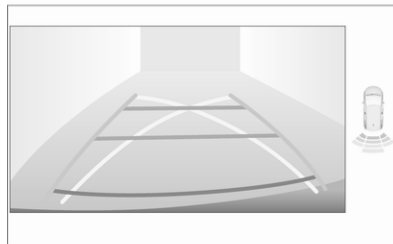

The vertical lines represent the width of the vehicle without mirrors and the general direction of the vehicle. The horizontal lines represent a distance of about 30 cm, 1m and 2 m beyond the rear bumper. The crossing curves represent the maximum turning circle.

Deactivation of guidelines

Guidelines can be deactivated in the Info Display. Select **Settings** ▶ **Vehicle** ▶ **Collision detection** ▶ **Rear view camera guide lines** ▶ **O**.

Info Display ⇨ 92.

Vehicle personalisation ⇨ 96.

Switching off

The camera is switched off when a certain forward speed is exceeded or if reverse gear is disengaged for approx. 10 seconds.

System limitations

The rear view camera may not operate properly when:

- The surrounding is dark.
- The beam of headlights is shining directly into the camera lenses.
- During nighttime driving.
- Weather limits visibility, such as fog, rain, or snow.
- The camera lenses are blocked by snow, ice, slush, mud, dirt. Clean the lense, rinse with water, and wipe with a soft cloth.
- The tailgate will be opened.
- A trailer or bike carrier is attached to the trailer hitch.
- The vehicle had a rear end accident.
- There are extreme temperature changes.

Lane departure warning

The lane departure warning system observes the lane markings between which the vehicle is driving via a front camera. The system detects lane changes and warns the driver in the event of an unintended lane change via visual and acoustic signals.

Criteria for the detection of an unintended lane change are:

- no operation of turn lights
- no brake pedal operation
- no active acceleration

If the driver is active, no warning will be issued.

Activation

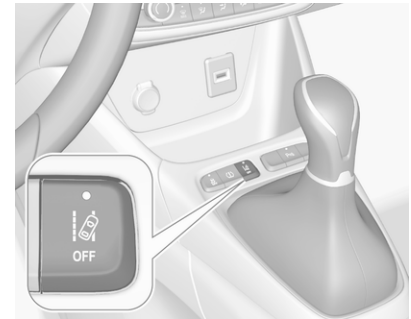

The lane departure warning system is activated by pressing . The system is switched on when the LED in the button is not illuminated.

The system is only operable at vehicle speeds above 37 mph and if lane markings are available.

When the system recognises an unintended lane change, the control indicator  flashes yellow. Simultaneously a chime sound is activated.



Deactivation

The system is deactivated by pressing , the LED in the button illuminates.

At speeds below 37 mph the system is inoperable.

Fault

In the event of a fault,  appears in the instrument cluster, accompanied by a display message. Seek the assistance of a workshop.

The system cannot operate when no lane marking is detected.

System limitations

The system may not operate properly when:

- vehicle speed is below 37 mph
- driving on winding or hilly roads

- driving in the dark
- weather limits visibility, such as fog, rain, or snow
- the camera is blocked by snow, ice, slush, mud, dirt, windscreen damage or affected by foreign items, e.g. stickers
- the sun is shining directly into the camera lens
- close vehicles ahead
- banked roads
- road edges
- roads with poor lane markings
- sudden lighting changes

Driver alert

The system cannot replace the need for vigilance on the part of the driver. Taking a break is recommended as soon as feeling tired or at least every two hours. Do not take the steering wheel when feeling tired.

Activation or Deactivation

The system can be activated or deactivated in the vehicle personalisation .

The state of the system stays in memory when the ignition is switched off.

Driving time alert

The driver gets notified by a pop-up reminder symbol  in the Driver Information Centre simultaneously with an acoustic alert if the driver has not taken a break after 2 hours of driving at a speed above 40 mph. The alert is repeated hourly until the vehicle is stopped, no matter how vehicle speed evolves.

The counting of driving time alert is reset when the ignition has been switched off for a few minutes.

Driver drowsiness detection

The system monitors the driver's level of vigilance. A camera in the windscreen detects variations in trajectory compared to the lane markings. This system is particularly suited for a speed higher than 40 mph.

If the trajectory of the vehicle suggests a certain level of drowsiness or inattention by the

driver, the system triggers the first level of alert. The driver is notified by a message and an audible signal is given.

After three first level alerts, the system triggers a new alert with a message, accompanied by a more pronounced audible signal.

In certain driving conditions (poor road surface or strong winds), the system may give alerts independent of the driver's level of vigilance.

The driver drowsiness detection is reinitialised when the ignition has been switched off for a few minutes or the speed remains below 40 mph for a few minutes.

System limitations

The system may not operate properly when:

- dazzle caused by headlights of an oncoming vehicles, low sun, reflections on damp roads
- driving on winding, hilly or narrow roads
- driving in the dark

- weather limits visibility, such as fog, rain, or snow
- the camera is blocked by snow, ice, slush, mud, dirt
- the windscreen is damaged or affected by foreign items, e.g. stickers
- the sun is shining directly into the camera lens
- close vehicles ahead
- banked roads
- road edges
- roads with poor lane markings
- multiple lane markings due to roadworks
- sudden lighting changes

Fuel

Fuel for petrol engines

The petrol engines are compatible with bio-fuels that conform to current and future European standards and can be obtained from filling stations:

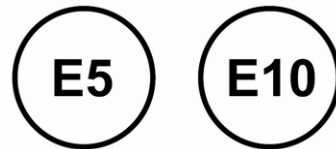

Petrol that meets the EN228 standard, mixed with a biofuel meeting the EN15376 standard.

Use fuel with the recommended octane rating. A lower octane rating can reduce engine power and torque and slightly increases fuel consumption.

Caution

Use of fuel with a lower octane rating than the lowest possible rating could lead to uncontrolled combustion and engine damage.

The engine-specific requirements regarding octane rating are given in the engine data overview ↗ 228. A country-specific label at the fuel filler flap can supersede the requirement.

Fuel for diesel engines

The diesel engines are compatible with bio-fuels that conform to current and future European standards and can be obtained from filling stations:

B7

Diesel fuel that meets standard EN590 mixed with a biofuel that meets standard EN14214 (possibly containing up to 7% Fatty Acid Methyl Ester).

B10

Diesel fuel that meets standard EN16734 mixed with a biofuel that meets standard EN14214 (possibly containing up to 10% Fatty Acid Methyl Ester).

XTL

Paraffinic diesel fuel that meets standard EN15940 mixed with a biofuel that meets standard EN14214 (possibly containing up to 7% Fatty Acid Methyl Ester).

B20**B30**

The use of B20 or B30 fuel meeting standard EN16709 is possible. However, this use, even occasional, requires strict application of the special servicing conditions referred to as "arduous conditions".

For further information, contact a workshop.

Caution

The use of any other type of (bio) fuel (vegetable or animal oils, pure or diluted, domestic fuel etc.) is strictly prohibited (risk of damage to the engine and fuel system).

Notice

The only diesel additives authorised for use are those that meet the B715000 standard.

Low temperature operation

At temperatures below 0 °C, some diesel products with biodiesel blends may clog, freeze or gel, which may affect the fuel supply system. Starting and engine operation may not work properly. Make sure to fill winter grade diesel fuel at ambient temperatures below 0 °C.

Arctic grade diesel fuel can be used at extremely low temperatures below -20 °C. Using this fuel grade in warm or hot climates is not recommended and may cause engine stalling, poor starting or damage on the fuel injection system.

Refuelling



⚠ Danger

Before refuelling, switch off ignition and any external heaters with combustion chambers.

Follow the operating and safety instructions of the filling station when refuelling.

⚠ Danger

Fuel is flammable and explosive. No smoking. No naked flames or sparks.

If you can smell fuel in your vehicle, have the cause of this remedied immediately by a workshop.

A label with symbols at the fuel filler flap is indicating the allowed fuel types. In Europe the pump nozzles of the filling stations are marked with these symbols. Refuel only the allowed fuel type.

Caution

In case of misfuelling, do not switch on ignition.

Fuel filler flap is located at left rear side of vehicle.



The fuel filler flap can only be opened if the vehicle is unlocked. Release the fuel filler flap by pushing the flap.

Petrol and diesel refuelling

To open, turn the cap slowly anticlockwise.

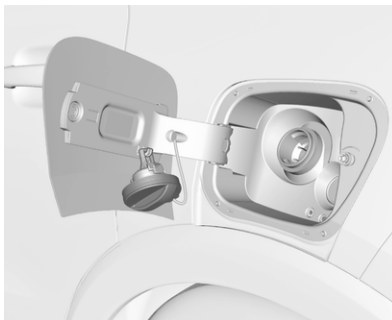

The fuel filler cap can be attached to the hook on the fuel filler flap.

Place the nozzle in straight position to the filler neck and press with slight force to insert.

To refuel, switch on pump nozzle.

After the automatic cut-off, the tank can be topped up by operating the pump nozzle a maximum of two more times.

Caution

Wipe off any overflowing fuel immediately.

To close, turn the fuel filler cap clockwise.

Close the flap and allow it to engage.

Fuel filler cap

Only use genuine fuel filler caps.

Diesel-engined vehicles have special fuel filler caps.

Trailer hitch

General information

Entrust retrofitting of towing equipment to a workshop. It may be necessary to make changes that affect the cooling system, heat shields or other equipment. Only use approved towing equipment.

The bulb outage detection function for trailer or bike carrier brake light cannot detect a partial bulb outage. E.g. in case of four bulbs with a power of 5 W each, the function only detects light outage when only a single 5 W light remains or none remain.

LED lights are not suitable for the wiring harness of this trailer hitch.

Towing equipment could cover the opening of the towing eye. If this is the case use the coupling ball bar for towing.

Driving characteristics and towing tips

Before attaching a trailer, lubricate the coupling ball. However, do not do so if a stabiliser, which acts on the coupling ball, is being used to reduce snaking movements.

During trailer towing do not exceed a speed of 50 mph. A maximum speed of 60 mph is only appropriate if an oscillation damper is used and the permissible gross trailer weight does not exceed the vehicle's curb weight.

For trailers with low driving stability and caravan trailers, the use of an oscillation damper is strongly recommended.

If the trailer starts snaking, drive more slowly, do not attempt to correct the steering and brake sharply if necessary.

When driving downhill, drive in the same gear as if driving uphill and drive at a similar speed.

Adjust tyre pressure to the value specified for full load ↗ 232.

Trailer towing

Trailer loads

The permissible trailer loads are vehicle and engine-dependent maximum values which must not be exceeded. The actual trailer load is the difference between the actual gross weight of the trailer and the actual coupling socket load with the trailer coupled.

The permissible trailer loads are specified in the vehicle documents. In general, they are valid for inclines up to 12%.

The permissible trailer load applies up to the specified incline and at sea level. Since engine power decreases as altitude increases due to the air becoming thinner, therefore reducing climbing ability, the permissible gross train weight also decreases by 10% for every 1000 m of altitude. The gross train weight does not have to be reduced when driving on roads with slight inclines (less than 8%, e.g. motorways).

The permissible gross train weight must not be exceeded. This weight is specified on the identification plate ⇨ 224.

Vertical coupling load

The vertical coupling load is the load exerted by the trailer on the coupling ball. It can be varied by changing the weight distribution when loading the trailer.

The maximum permissible vertical coupling load of 65 kg is specified on the towing equipment identification plate and in the vehicle documents. For vehicles with engine DV5RC and automatic transmission, the maximum permissible vertical coupling load is 55 kg. Always aim for the maximum load, especially in the case of heavy trailers. The vertical coupling load should never fall below 25 kg.

Rear axle load

When the trailer is coupled and the towing vehicle fully loaded, the permissible rear axle load (see identification plate or vehicle documents) may be exceeded by 60 kg, the gross vehicle weight rating must not be exceeded. If the permissible rear axle load is exceeded, a maximum speed of 60 mph applies.

Towing equipment

Caution
When operating without a trailer, remove the coupling ball bar.

Stowage of coupling ball bar

The bag with the coupling ball bar is stowed on the rear floor cover in the load compartment.

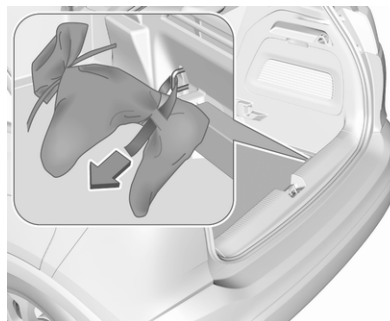

Place the strap through the rear right lashing eye, wrap around twice and tighten the strap to secure the bag.

Fitting the coupling ball bar

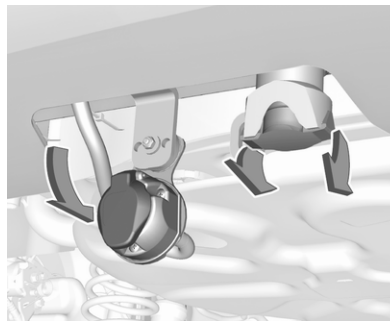



Swivel the connecting socket downwards. Remove the sealing plug from the opening for the coupling ball bar and stow it.

Checking the tensioning of the coupling ball bar

- Red marking on rotary knob must point towards green marking on coupling ball bar.
- The gap between the rotary knob and the coupling ball bar must be approx. 6 mm.
- The key must be in position .

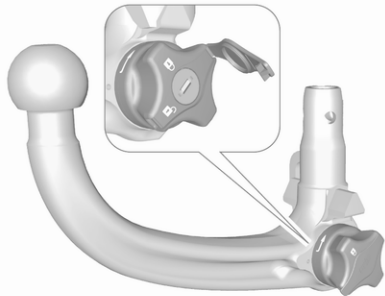
Otherwise, the coupling ball bar must be tensioned before being inserted:



- Unlock coupling ball bar by turning key to position .

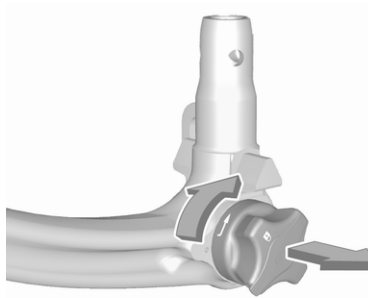

- Pull out rotary knob and turn clockwise as far as it will go.

Inserting the coupling ball bar

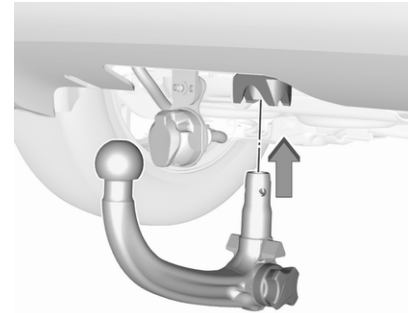

Insert the tensioned coupling ball bar in the opening and push firmly upwards until it audibly engages.

The rotary handle snaps back into its original position resting against the coupling ball bar without a gap.

Warning

Do not touch rotary handle during insertion.

Lock the coupling ball bar by turning the key to position . Remove the key and close the protective flap.

Eye for break-away stopping cable

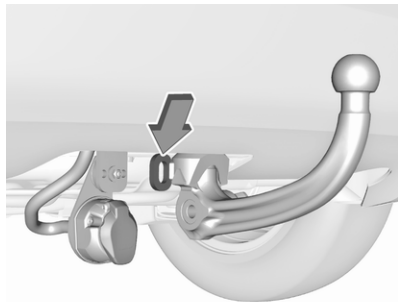

Attach breakaway stopping cable to eye.

Checking the correct installation of the coupling ball bar

- Green marking on rotary knob must point towards green marking on coupling ball bar.
- There must be no gap between the rotary handle and the coupling ball bar.
- The coupling ball bar must be firmly engaged in the opening.
- The coupling ball bar must be locked and the key removed.

⚠ Warning

Towing a trailer is permitted only when a coupling ball bar is fitted correctly. If the coupling ball bar does not engage correctly, seek the assistance of a workshop.

Dismounting the coupling ball bar

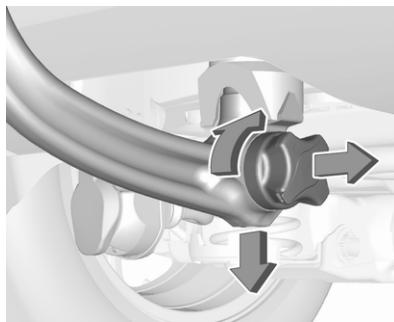

Open the protective flap and turn the key to position  to unlock the coupling ball bar.

Pull out rotary handle and turn clockwise as far as it will go. Pull out coupling ball bar downwards.

Insert sealing plug in opening.

Swivel the connecting socket upwards.

Stow the coupling ball bar in the bag and secure by fixing the strap through the rear right lashing eye. Wrap around twice and tighten the strap to secure the bag.

Vehicle care

General Information	177
Accessories and vehicle modifications	177
Vehicle storage	178
End-of-life vehicle recovery	178
Vehicle checks	179
Performing work	179
Bonnet	179
Engine oil	180
Engine coolant	181
Washer fluid	181
Brakes	182
Brake fluid	182
Vehicle battery	182
Diesel fuel system bleeding	184
Wiper blade replacement	184
Bulb replacement	185
Halogen headlights	185
LED headlights	188
Front fog lights	188
Tail lights	188
Side turn lights	192
Number plate light	193
Interior lights	193

Electrical system	193
Fuses	193
Engine compartment fuse box	194
Instrument panel fuse box	196
Vehicle tools	198
Tools	198
Wheels and tyres	199
Winter tyres	199
Tyre designations	199
Tyre pressure	199
Tyre deflation detection system	200
Tread depth	201
Changing tyre and wheel size	202
Wheel covers	202
Tyre chains	202
Tyre repair kit	203
Wheel changing	206
Spare wheel	207
Jump starting	211
Towing	212
Towing the vehicle	212
Towing another vehicle	213
Appearance care	214
Exterior care	214
Interior care	216
Floor mats	217

General Information

Accessories and vehicle modifications

We recommend the use of genuine parts and accessories and factory approved parts specific for this vehicle type. We cannot assess or guarantee reliability of other products - even if they have a regulatory or otherwise granted approval.

Any modification, conversion or other changes made to standard vehicle specifications (including, without limitation, software modifications, modifications of the electronic control units) may invalidate the warranty offered by Vauxhall.

Furthermore, such changes may affect driver assistance systems, may impact fuel consumption, CO₂ emissions and other emissions of the vehicle and cause the vehicle to no longer conform to the operating permit, impacting the validity of your vehicle registration.

Caution

When transporting the vehicle on a train or on a recovery vehicle, the mud flaps might be damaged.

Vehicle storage**Storage for a long period of time**

If the vehicle is to be stored for several months:

- Wash and wax the vehicle.
- Have the wax in the engine compartment and underbody checked.
- Clean and preserve the rubber seals.
- Fill up fuel tank completely.
- Change the engine oil.
- Drain the washer fluid reservoir.
- Check the coolant antifreeze and corrosion protection.
- Adjust tyre pressure to the value specified for full load.

- Park the vehicle in a dry, well ventilated place. Prevent the vehicle from rolling.
- Engage first or reverse gear or set selector lever to **P**.
- Do not apply the parking brake.
- Open the bonnet, close all doors and lock the vehicle.
- Disconnect the clamp from the negative terminal of the vehicle battery. Note that all systems are not functional, e.g. central locking system.

Anti-theft alarm system ⇨ 31.

Putting back into operation

When the vehicle is to be put back into operation:

- Connect the clamp to the negative terminal of the vehicle battery. Initialize the power windows ⇨ 36.
- Check tyre pressure.
- Fill up the washer fluid reservoir.
- Check the engine oil level.

- Check the coolant level.
- Fit the number plate if necessary.

End-of-life vehicle recovery

Information on end-of-life vehicle recovery centres and the recycling of end-of-life vehicles is available on our website, where legally required. Only entrust this work to an authorised recycling centre.

Vehicle checks

Performing work

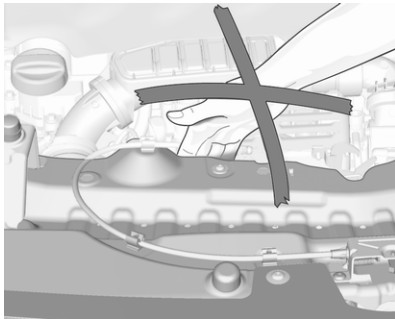

⚠ Warning

Only perform engine compartment checks when the ignition is off.
The cooling fan may start operating even if the ignition is off.

⚠ Danger

The ignition system uses extremely high voltage. Do not touch.

Bonnet

Opening

Open the driver's door.

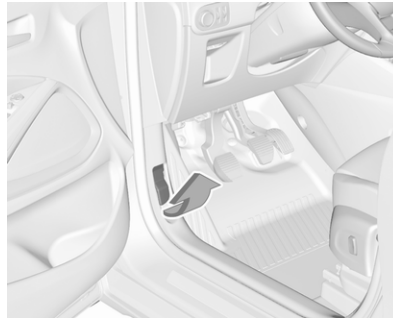

Pull the lever and return it to its original position.

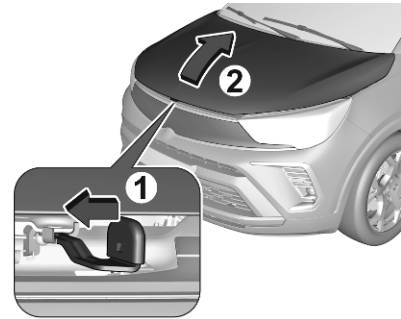

Move the safety catch sideways to the left vehicle side and open the bonnet. Secure the bonnet support.

Closing

Before closing the bonnet, press the support into the holder.
Lower the bonnet and let it fall into the latch from a low height (20-25 cm). Check that the bonnet is engaged.

Caution

Do not press the bonnet into the latch to avoid dents.

Engine oil

Check the engine oil level manually on a regular basis to prevent damage to the engine. Ensure that the correct specification of engine oil is used.

Recommended fluids and lubricants
 ⇨ 222.

The maximum engine oil consumption is 0.6 l per 600 miles.

Check with the vehicle on a level surface. The engine must be at operating temperature and switched off for at least 5 minutes.

Caution

It is the owner's responsibility to maintain the proper level of an appropriate quality engine oil in the engine.

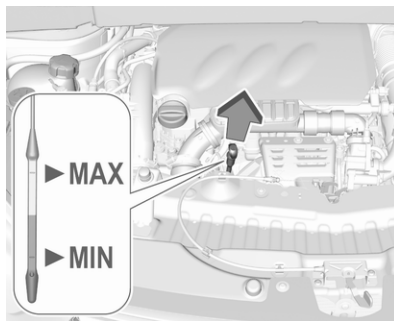

Pull out the dipstick, wipe it clean, reinsert it fully, pull out and read the engine oil level.

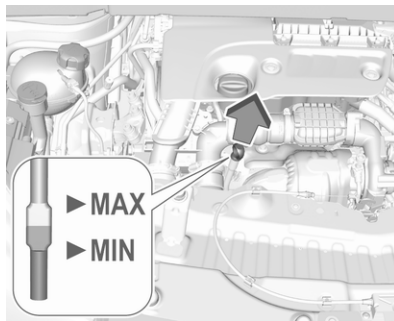

Different dipsticks are used depending on engine variant.

When the engine oil level has dropped to the **MIN** mark, top up the engine oil. We recommend the use of the same grade of engine oil that was used at last change.

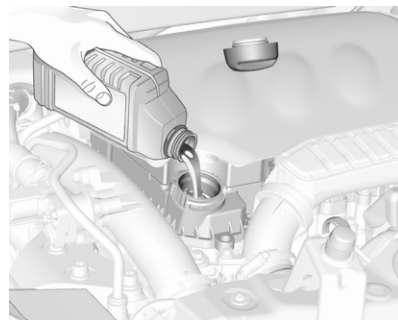

The engine oil level must not exceed the **MAX** mark on the dipstick.

Caution

Overfilled engine oil must be drained or suctioned out. If the engine oil exceeds the maximum level, do not start the vehicle and contact a workshop.

Capacities ⇨ 231.

Fit the cap on straight and tighten it.

Engine coolant

The factory filled coolant provides freeze protection down to approx. -37 °C.

Caution

Only use approved antifreeze.

Coolant and antifreeze ⇨ 222.

Coolant level

Caution

Too low a coolant level can cause engine damage.

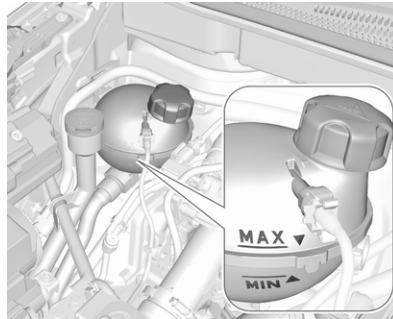

If the cooling system is cold, the coolant level should be above the **MIN** mark. Top up if the level is low.

⚠ Warning

Allow the engine to cool before opening the cap. Carefully open the cap, relieving the pressure slowly.

To top up, use a 1:1 mixture of released coolant concentrate mixed with clean tap water. If no coolant concentrate is available, use clean tap water. Install the cap tightly. Have

the coolant concentration checked and have the cause of the coolant loss remedied by a workshop.

Washer fluid

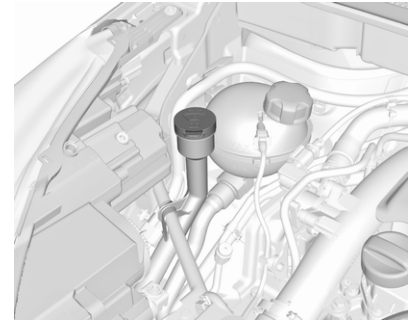

Fill with clean water mixed with a suitable quantity of approved windscreen washer fluid which contains antifreeze.

Caution

Only washer fluid with a sufficient antifreeze concentration provides protection at low temperatures or a sudden drop in temperature.

Washer fluid ↗ 222.

Brakes

In the event of minimum thickness of the brake lining, a squealing noise sounds during braking.

Continued driving is possible but have the brake lining replaced as soon as possible.

Once new brake linings are installed, do not brake unnecessarily hard for the first few journeys.

Brake fluid**⚠ Warning**

Brake fluid is poisonous and corrosive. Avoid contact with eyes, skin, fabrics and painted surfaces.

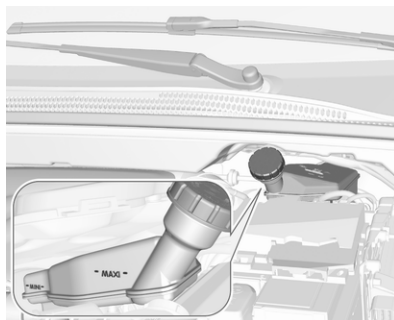

The brake fluid level must be between the **MIN** and **MAX** marks.

If fluid level is below **MIN** seek the assistance of a workshop.

Brake fluid ↗ 222.

Vehicle battery

The vehicle battery is maintenance-free provided that the driving profile allows sufficient charging of the battery. Short-distance-driving and frequent engine starts can discharge the battery. Avoid the use of unnecessary electrical consumers.



Batteries do not belong in household waste. They must be disposed of at an appropriate recycling collection point.

Laying up the vehicle for more than four weeks can lead to battery discharge. Disconnect the clamp from the negative terminal of the vehicle battery.

Ensure the ignition is switched off before connecting or disconnecting the vehicle battery.

Battery discharge protection ↗ 110.

Anti-theft alarm system ↗ 31.

Replacing the vehicle battery**Notice**

Any deviation from the instructions given in this section may lead to temporary deactivation or disturbance of the stop-start system.

When the vehicle battery is being replaced, ensure that there are no open ventilation holes in the vicinity of the positive terminal. If a ventilation hole is open in this area, it must be closed off with a dummy cap, and the ventilation in the vicinity of the negative terminal must be opened.

Ensure that the vehicle battery is always replaced by the same type of battery.

The vehicle battery has to be replaced by a workshop.

Stop-start system ⇨ 127.

Charging the vehicle battery

Warning

On vehicles with stop-start system, ensure that the charging potential does not exceed 14.6 V when using a battery charger. Otherwise the vehicle battery may be damaged.

Jump starting ⇨ 211.

Discharge protection

Battery voltage

When the vehicle battery voltage is running low, a warning message will appear in the Driver Information Centre.

When the vehicle is being driven, the load reduction function temporarily deactivates certain functions, e.g. the heated rear window.

The deactivated functions are reactivated automatically as soon as conditions permit.

Idle boost

If charging of the vehicle battery is required due to battery condition, the power output of the generator must be increased. This will be achieved by an idle boost which may be audible.

A message appears in the Driver Information Centre.

Power outlet

The power outlets are deactivated in the event of low vehicle battery voltage.

Warning label



Meaning of symbols:

- No sparks, naked flames or smoking.
- Always shield eyes. Explosive gases can cause blindness or injury.
- Keep the vehicle battery out of reach of children.
- The vehicle battery contains sulphuric acid which could cause blindness or serious burn injuries.

- See the Owner's Manual for further information.
- Explosive gas may be present in the vicinity of the vehicle battery.

Power saving mode

This mode deactivates electrical consumers to avoid excessive discharging of the vehicle battery. These consumers, such as the infotainment system, windscreen wipers, low beam headlights, courtesy light, etc. can be used for a total maximum time of about 40 minutes after ignition is switched off.

Deactivating power saving mode

Power saving mode is deactivated automatically when the engine is restarted. Run the engine for a sufficient charge:

- for less than 10 minutes to use the consumers for approx. 5 minutes
- for more than 10 minutes to use the consumers for up to approx. 30 minutes

Diesel fuel system bleeding

If the tank has been run dry, the diesel fuel system must be bled. Switch on the ignition three times for 15 seconds at a time. Then crank the engine for a maximum of 40 seconds. Repeat this process after no less than 5 seconds. If the engine fails to start, seek the assistance of a workshop.

Wiper blade replacement

Windscreen

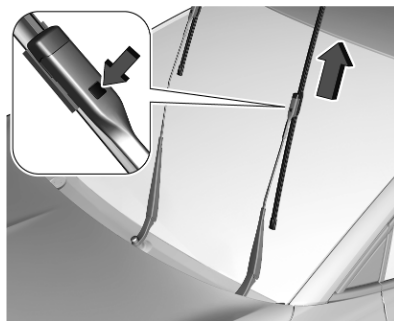

Switch off ignition.

Within one minute after switching off ignition, operate the wiper lever to position the wiper blades vertically on the windscreen.

Lift the wiper arm until it stays in the raised position, press button to disengage the wiper blade and remove.

Attach the wiper blade slightly angled to the wiper arm and push until it engages.

Lower wiper arm carefully.

Rear window

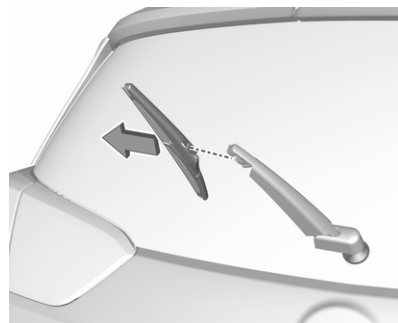

Lift wiper arm. Disengage wiper blade as shown in illustration and remove.

Attach the wiper blade slightly angled to the wiper arm and push until it engages.

Lower wiper arm carefully.

Bulb replacement

Before replacing a bulb, ensure that all exterior and interior lights and the ignition are switched off. All doors have to be closed.

Only hold a new bulb at the base. Do not touch the bulb glass with bare hands.

Use only the same bulb type for replacement.

Replace headlight bulbs from within the engine compartment.

Bulb check

After a bulb replacement switch on the ignition, operate and check the lights.

Halogen headlights

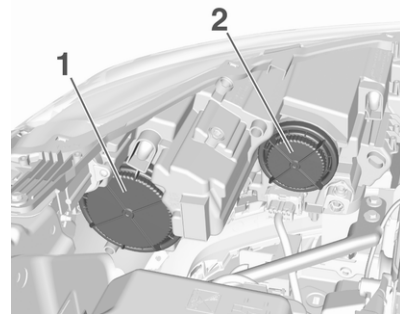

1 : high beam, turn light

2 : low beam

High beam

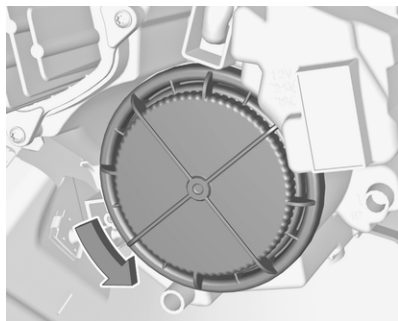

1. Rotate the cap anticlockwise and remove it.

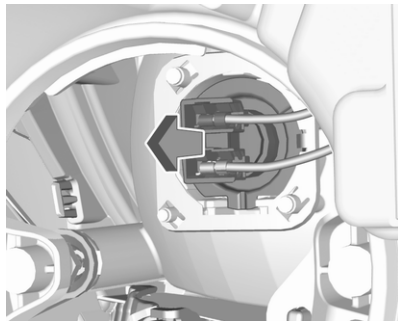

2. Withdraw the upper bulb socket from the reflector housing.

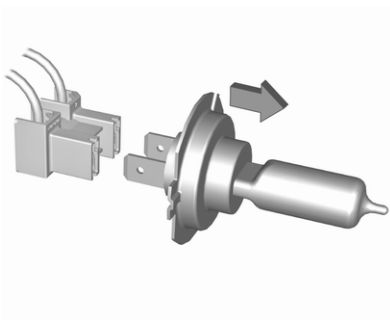

3. Remove the bulb from the plug connector by pulling.
4. Replace the bulb and connect it to the plug connector.
5. Insert and push the bulb socket into the reflector housing by setting the lug into position.
6. Fit the cap and rotate clockwise.

Turn light

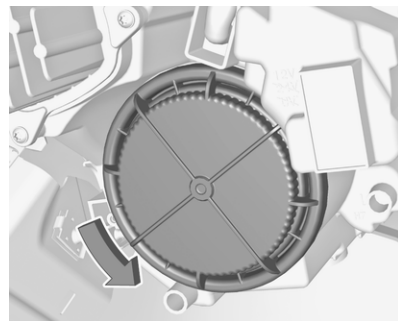

1. Rotate the cap anticlockwise and remove it.

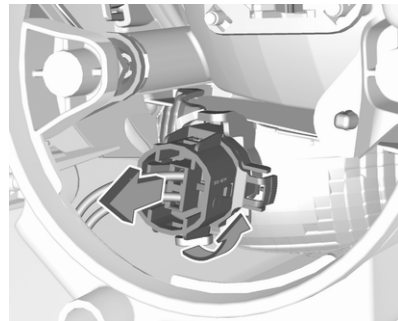

2. Rotate the lower bulb socket anticlockwise to disengage. Withdraw the bulb socket from the reflector housing.

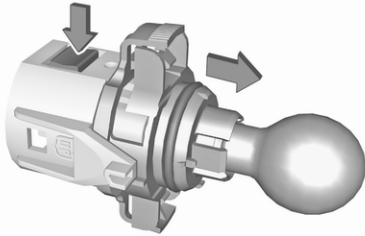

3. Press latch and remove the bulb from the bulb socket.
4. Replace the bulb and attach it to the bulb socket.
5. Insert the bulb socket into the reflector housing and rotate clockwise.
6. Fit the cap and rotate clockwise.

Low beam

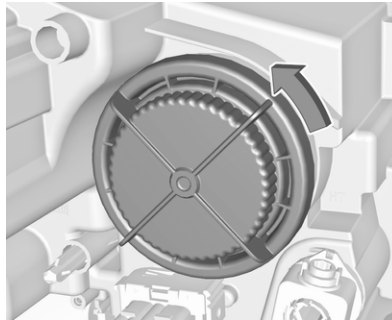

1. Rotate the cap anticlockwise and remove it.

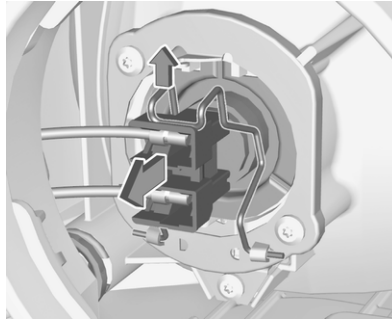

2. Lift the retainer, then pull the plug connector backwards.
3. Fold down the retainer and remove the bulb from the reflector housing.

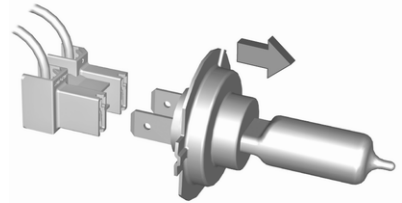

4. Replace the bulb and push it into the reflector housing by setting the lug into position.
5. Fold up the retainer and hold in position.
6. Attach the plug connector to the bulb and fix it with the retainer.
7. Fit the cap and rotate clockwise.

Sidelight / daytime running light

In case of defective LEDs, have them replaced by a workshop.

LED headlights

Headlights for low and high beam, sidelights, daytime running lights and turn lights are designed as LEDs and cannot be changed.

Have lights repaired by a workshop in case of failure.

Eco-LED headlights

The turn lights are designed as bulbs.

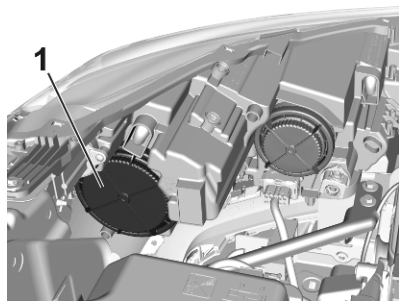

1. Rotate the cap anticlockwise and remove it.

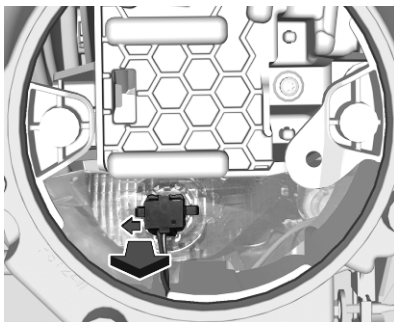

2. Push the bulb socket to the left and withdraw it from the reflector housing.

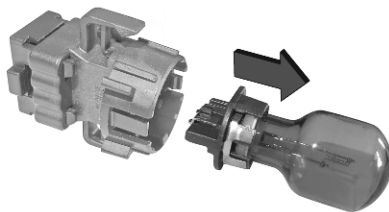

3. Remove the bulb from the plug connector by pulling.
4. Replace the bulb and connect it to the plug connector.
5. Insert the bulb socket into the reflector housing and push it forwards until it engages.
6. Fit the cap and rotate clockwise.

Front fog lights

The front fog lights are designed as LEDs and cannot be changed. In case of defective LEDs, have them replaced by a workshop.

Tail lights

Depending on version, tail lights and brake lights are designed as LEDs. In case of defective LEDs, have them replaced by a workshop.

Light assembly in the body

Detaching the light assembly



1. Unscrew the two screws that secure the light assembly.

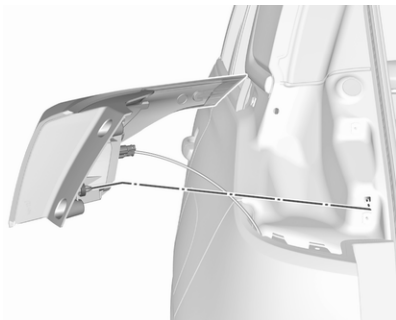

2. Remove the light assembly by pulling it straight back.
3. Remove the bulb socket.
 - a) Version without LED:

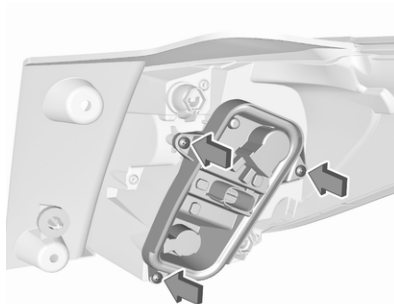

Remove the three screws and take out.

- b) Version with LED:

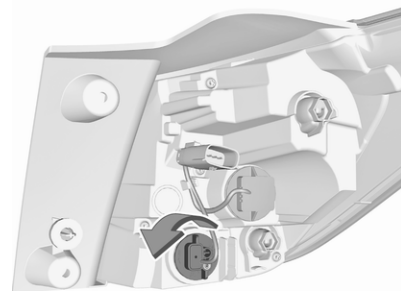

Remove from the light assembly by turning it anticlockwise.

4. Remove the bulb.
 - a) Version without LED:

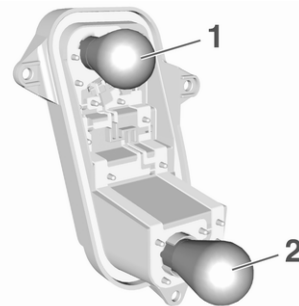

Pull and replace.

- 1 : tail light / brake light
- 2 : turn light
- b) Version with LED:

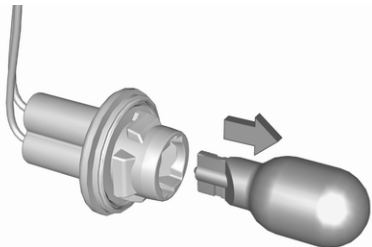

Pull straight out to remove from the socket and replace.

Attaching the light assembly

- 1. Depending on version, attach the bulb carrier to the light assembly and secure with the three screws or attach turn light bulb socket.

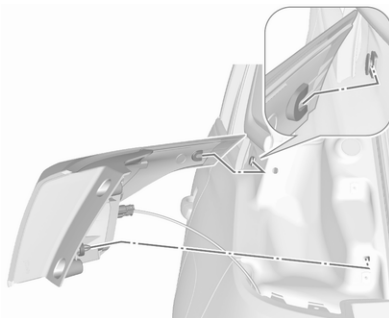

- 2. Attach the light assembly to the vehicle body and secure with the two screws.

Light assembly in the tailgate

Detaching the light assembly



- 1. Release the cover in the tailgate and remove it.

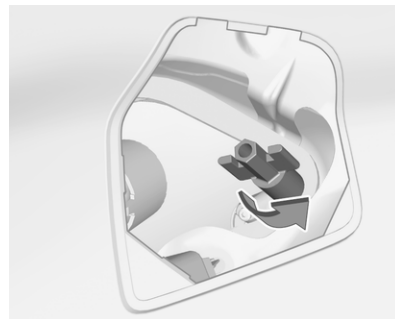

2. Unscrew the plastic nut by hand.



3. Carefully withdraw the light assembly from the recesses and remove.

4. Remove bulb socket.

a) Version without LED:

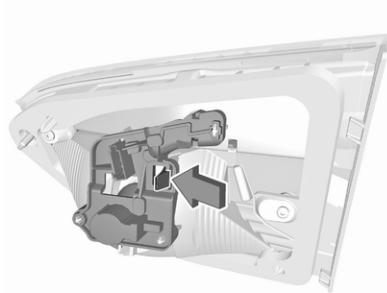

Press latch to release and remove bulb socket.

b) Version with LED:

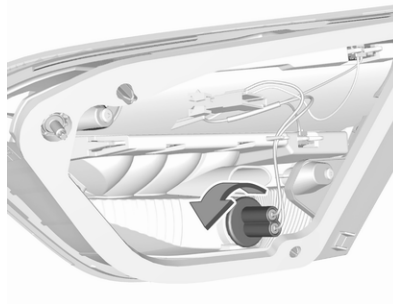

Remove the reverse light bulb socket from the light assembly by turning it anticlockwise.

5. Remove bulb.

a) Version without LED:

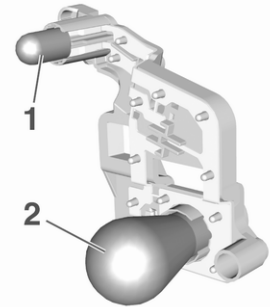

Remove and replace.

1 : tail light

2 : rear fog light or reverse light

b) Version with LED:

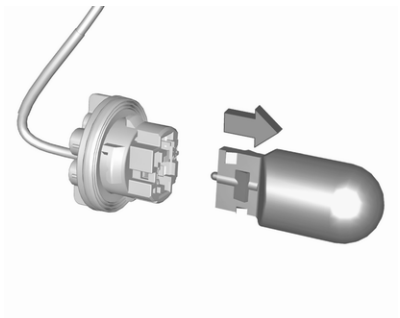

Pull straight out to remove and replace.

Attaching the light assembly

1. Depending on version, attach the bulb carrier to the light assembly or attach the reverse light bulb socket.



2. Attach the light assembly to the tailgate.
3. Secure the light assembly with the plastic nut.
4. Attach the cover to the tailgate.

Side turn lights

To replace bulb, remove light assembly:

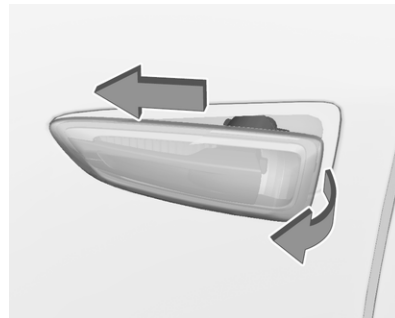

1. Slide the light assembly forward and remove it at the back.



2. Turn bulb socket anticlockwise and remove from light assembly.

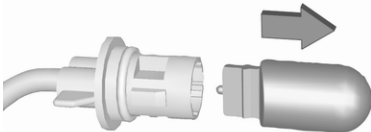

3. Pull bulb from bulb socket and replace it.

4. Insert bulb socket and turn clockwise.
5. Insert left end of the light assembly, slide to the left and insert right end.

Number plate light

The number plate light is designed as LEDs and cannot be changed. In case of defective LEDs, have them replaced by a workshop.

Interior lights

Have the following bulbs replaced by a workshop:

- courtesy light, reading lights
- load compartment light
- instrument panel illumination

Electrical system

Fuses

Data on the replacement fuse must match the data on the defective fuse.

The three fuse boxes are located in:

- engine compartment
- instrument panel

Before replacing a fuse, turn off the respective switch and the ignition.

A blown fuse can be recognised by its melted wire.

Caution

Do not replace the fuse until the cause of the fault has been remedied.

Some functions are protected by several fuses.

Fuses may also be inserted without existence of a function.

Fuse extractor

A fuse extractor may be located in the fuse box in the engine compartment.

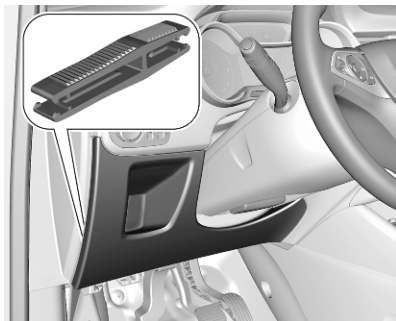

Depending on version, a fuse extractor may be located on the backside of the cover in the instrument panel

The extractor has two sides, each side is designed for a different type of fuses.

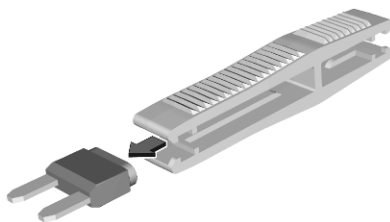

Grab the fuse with the fuse extractor and withdraw the fuse.

Engine compartment fuse box

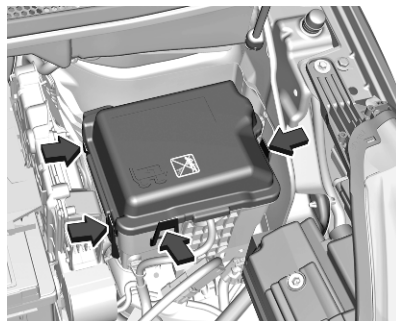

The fuse box is in the front left of the engine compartment.

Disengage the cover and remove it.

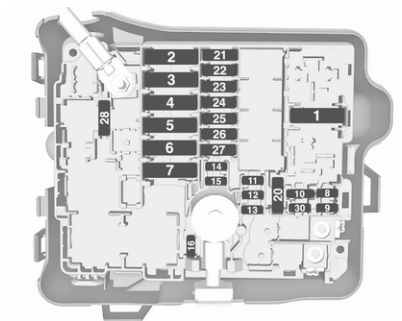

No. Circuit

- 1 Fan climate control system
- 2 –
- 3 Body fuse box
- 4 –
- 5 Instrument panel fuse box
- 6 Engine cooling unit
- 7 Body control module
- 8 Engine control fuel pump
- 9 Engine control

No. Circuit

- 10 Engine control
- 11 Engine control
- 12 Engine cooling unit
- 13 Body control module
- 14 Intelligent battery sensor
- 15 –
- 16 Front fog lights
- 17 –
- 18 High beam right
- 19 High beam left
- 20 Engine control fuel pump
- 21 Starter
- 22 –
- 23 Starter
- 24 Trailer hitch
- 25 Instrument panel fuse box
- 26 Transmission control module

No. Circuit

- 27 Body control module
- 28 Engine control module
- 29 Front wiper
- 30 Body control module

After having changed defective fuses, close the fuse box cover and press until it engages.

If the fuse box cover is not closed correctly, malfunction may occur.

Instrument panel fuse box

Fuse box on the left side of the instrument panel

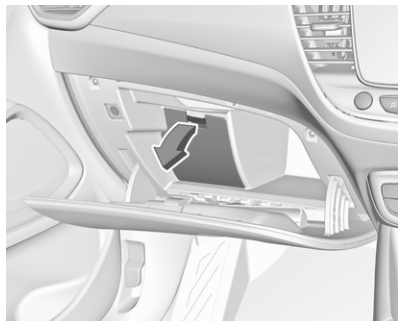

In right-hand drive vehicles, the fuse box is located behind a cover in the glovebox. Open the glovebox and remove the cover.

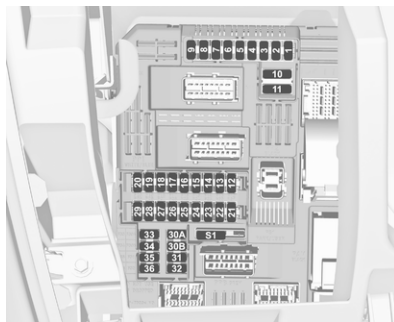

No. Circuit

- | No. | Circuit |
|-----|--|
| 1 | Interior mirror, exhaust system, electric power steering, clutch sensor, LPG, exterior mirror adjustment, inductive charging |
| 2 | – |
| 3 | Trailer hitch |
| 4 | Horn |
| 5 | Windscreen washer pump front / rear |
| 6 | Windscreen washer pump front / rear |

No. Circuit

- | No. | Circuit |
|-----|--|
| 7 | Heated steering wheel |
| 8 | Rear wiper |
| 9 | – |
| 10 | Central locking system |
| 11 | Central locking system |
| 12 | Instrument cluster |
| 13 | Climate control system, USB |
| 14 | BTA module |
| 15 | Instrument cluster, climate control system |
| 16 | Brake, starter, retained power off |
| 17 | Instrument cluster |
| 18 | Advanced parking assist |
| 19 | Top column module, trailer control module |
| 20 | – |
| 21 | Anti-theft alarm system, start button |

No. Circuit

- 22 Rain sensor, front camera
- 23 Door module
- 24 Advanced parking assist, camera, Infotainment
- 25 Airbag
- 26 Top column module
- 27 Anti-theft alarm system
- 28 –
- 29 Infotainment
- 30 –
- 31 Infotainment
- 32 Power outlet front
- 33 –
- 34 Heated exterior mirrors, door module

No. Circuit

- 35 Instrument cluster, light switch, advanced parking assist, transmission control module
- 36 Courtesy lights, sun visor lights, glovebox light

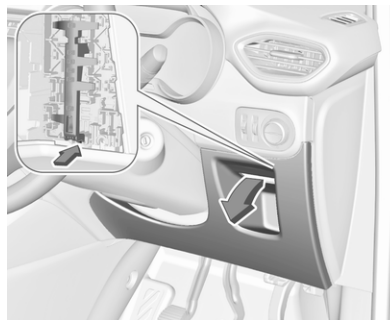
Fuse box on the right side of the instrument panel

In right-hand drive vehicles, the fuse box is behind a cover in the instrument panel. Disengage cover at the side and remove.

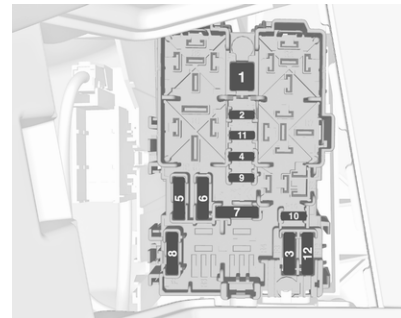
**No. Circuit**

- 1 Heated rear window
- 2 Heated exterior mirrors
- 3 Front power window
- 4 Driver's door control unit
- 5 Rear power window
- 6 Heated seats
- 7 –
- 8 Infotainment
- 9 –

No. Circuit

10 Power outlet rear

11 –

12 –

Vehicle tools

Tools

Vehicles with spare wheel

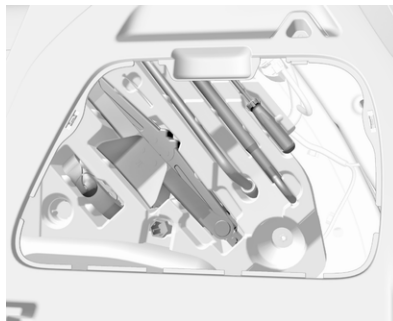

The jack, tools, a strap for securing a damaged wheel and the towing eye are placed in the tool box in the right wall of the load compartment.

Spare wheel ↪ 207.

Vehicles without spare wheel

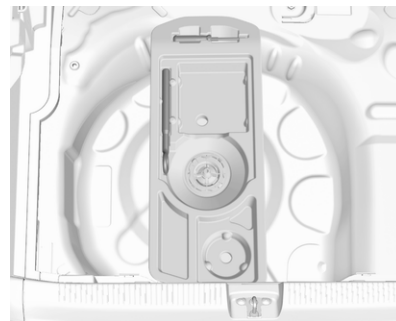

The screwdriver and the towing eye are located in a box below the floor cover in the load compartment.

Tyre repair kit ↪ 203.

Wheels and tyres

Tyre condition, wheel condition

Drive over edges slowly and at right angles if possible. Driving over sharp edges can cause tyre and wheel damage. Do not trap tyres on the kerb when parking.

Regularly check the wheels for damage. Seek the assistance of a workshop in the event of damage or unusual wear.

Winter tyres

Winter tyres improve driving safety at temperatures below 7 °C and should therefore be fitted on all wheels.

In accordance with country-specific regulations, affix the speed sticker in the driver's field of view.

All tyre sizes are permitted as winter tyres ⇨ 232.

Tyre designations

E.g. **195/65 R 15 91 T**

- 195** : tyre width, mm
- 65** : cross-section ratio (tyre height to tyre width), %
- R** : belt type: Radial
- RF** : type: RunFlat
- 15** : wheel diameter, inches
- 91** : load index e.g. 95 is equivalent to 615 kg
- T** : speed code letter

Speed code letter:

- Q** : up to 100 mph
- S** : up to 112 mph
- T** : up to 118 mph
- H** : up to 130 mph
- V** : up to 150 mph
- W** : up to 168 mph

Choose a tyre appropriate for the maximum speed of this vehicle. Refer to the EEC Certificate of Conformity provided with the vehicle or other national registration documents. Optional equipment could reduce the maximum speed of the vehicle.

Directional tyres

Directional tyres should be mounted so that they rotate in the correct direction. The proper rotation direction is indicated by a symbol (e.g. an arrow) on the sidewall.

Tyre pressure

Check the pressure of cold tyres at least every 14 days and before any long journey.

Do not forget the spare wheel.



The tyre pressure information label on the left door frame indicates the original equipment tyres and the correspondent tyre pressures.

The tyre pressure data refers to cold tyres. It applies to summer and winter tyres.

Always inflate the spare tyre to the pressure specified for full load.

The ECO tyre pressure serves to achieve the smallest amount of fuel consumption possible.

Incorrect tyre pressures will impair safety, vehicle handling, comfort and fuel economy and will increase tyre wear.

The tyre pressure table indicates the required pressure for a specific tyre size only and shows all possible tyre combinations ↗ 232.

For the tyres approved for this vehicle, refer to the EEC Certificate of Conformity provided with the vehicle or other national registration documents.

The driver is responsible for correct adjustment of tyre pressure.

Warning

If the pressure is too low, this can result in considerable tyre warm-up and internal damage, leading to tread separation and even to tyre blow-out at high speeds.

Warning

For specific tyres the recommended tyre pressure as shown in the tyre pressure table may exceed the maximum tyre pressure as indicated on the tyre. Never exceed the maximum tyre pressure as indicated on the tyre.

Temperature dependency

The tyre pressure depends on the temperature of the tyre. During driving, tyre temperature and pressure increase. Tyre pressure values provided on the tyre information label and tyre pressure chart are valid for cold tyres, which means at 20 °C.

The pressure increases by nearly 1.5 psi for a 10 °C temperature increase. This must be considered when warm tyres are checked.

Tyre deflation detection system

The tyre deflation detection system continually checks the rotation speed of all four wheels and warns on low tyre pressure condition once vehicle is driving. This is achieved by comparing tyre rolling circumference with reference values and further signals.

If a tyre loses pressure the control indicator  illuminates and a warning message is displayed in the Driver Information Centre.

In this case reduce speed, avoid sharp cornering and strong braking. Stop at next safe opportunity and check tyre pressure.

Control indicator  ↗ 87.

After adjusting tyre pressure initialise system to extinguish the control indicator and restart system.

Caution

Deflation detection system warns just about low tyre pressure condition and does not replace regular tyre maintenance by the driver.

In case of a system malfunction a message is displayed in the Driver Information Centre. Set correct tyre pressure and reinitialise system. If the failure continues to be displayed, contact a workshop. The system is inoperable when ABS or ESC has a malfunction or a temporary spare wheel is used.

In case of a system malfunction a message is displayed in the Driver Information Centre. Set correct tyre pressure and reinitialise system. If the failure continues to be displayed, contact a workshop. The system is inoperable when ABS or ESC has a malfunction.

Once the road tyre has been refitted, check the tyre pressure with cold tyres and initialise the system.

System initialisation

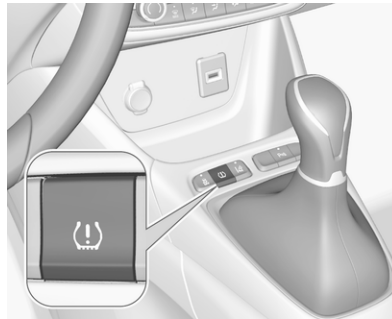

After tyre pressure correction or wheel change, the system must be initialised to learn new circumference reference values:

1. Always ensure that all four tyres have correct tyre pressure ↻ 232.
2. Apply parking brake.
3. Press (⏏) to reset deflation detection system.
4. Reset is confirmed by pop-up indication.

After initialisation system automatically calibrates to new tyre pressures during driving. After longer drive the system will adopt and monitor new pressures.

Always check tyre pressure with cold tyres.

System has to be reinitialised when:

- tyre pressure has been changed
- load condition has been changed
- wheels have been swapped or exchanged

The system will not warn instantaneously on a tyre blow out or a rapid deflation. This is due to required calculation time.

Tread depth

Check tread depth at regular intervals.

Tyres should be replaced for safety reasons at a tread depth of 2-3 mm (4 mm for winter tyres).

For safety reasons, it is recommended that the tread depth of the tyres on one axle should not vary by more than 2 mm.



The legally permissible minimum tread depth (1.6 mm) has been reached when the tread has worn down as far as one of the tread wear indicators (TWI). Their position is indicated by markings on the sidewall.

If there is more wear at the front than the rear, swap round front wheels and rear wheels periodically. If directional tyres are mounted, ensure that the direction of rotation of the wheels remains the same.

Tyres age, even if they are not used. We recommend tyre replacement every 6 years.

Changing tyre and wheel size

If tyres of a different size than those fitted at the factory are used, it may be necessary to reprogramme the tyre deflation detection system and make other vehicle modifications.

Tyre deflation detection system
↪ 200.

Have the label with tyre pressures replaced.

⚠ Warning

The use of unsuitable tyres or wheels may lead to accidents and will invalidate the vehicle operating permit.

Wheel covers

Wheel covers and tyres that are factory approved for the respective vehicle and comply with all of the relevant wheel and tyre combination requirements must be used.

If the wheel covers and tyres used are not factory approved, the tyres must not have a rim protection ridge.

Wheel covers must not impair brake cooling.

⚠ Warning

Use of unsuitable tyres or wheel covers could lead to sudden pressure loss and thereby accidents.

Vehicles with steel wheels: When using locking wheel nuts, do not attach wheel covers.

Tyre chains

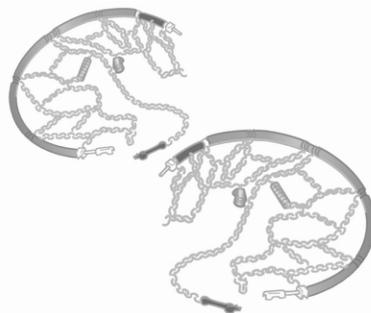

Tyre chains are only permitted on the front wheels.

Always use fine mesh chains that add no more than 10 mm to the tyre tread and the inboard sides (including chain lock).

⚠ Warning

Damage may lead to tyre blowout.

Tyre chains are only permitted on tyres of size 195/65 R15 91 and 195/60 R16 89

Temporary spare wheel

The use of tyre chains is not permitted on the temporary spare wheel.

Tyre repair kit

Minor damage to the tyre tread can be repaired with the tyre repair kit.

Do not remove foreign bodies from the tyres.

Tyre damage exceeding 4 mm or that is at tyre's sidewall cannot be repaired with the tyre repair kit.

⚠ Warning

Do not drive faster than 50 mph.
Do not use for a lengthy period.
Steering and handling may be affected.

If you have a flat tyre:

Apply the parking brake and engage first gear, reverse gear or **P**.

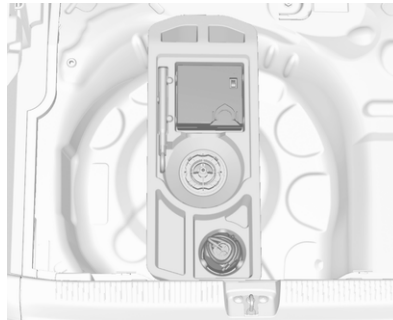

The tyre repair kit is in the load compartment below the floor cover.

1. Remove the sealant bottle and the compressor.

2. Pull speed limit label from sealant bottle and place it in driver's visible area.

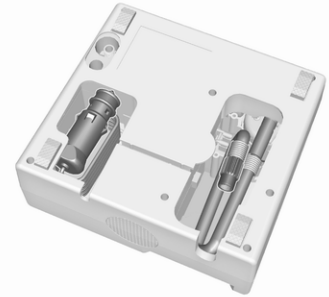

3. Remove the electrical connection cable and air hose from the storage compartments on the underside of the compressor.

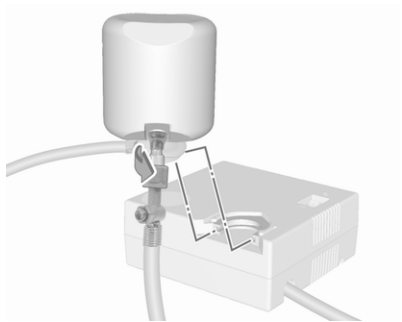

4. Screw the compressor air hose to the connection on the sealant bottle.
5. Fit the sealant bottle into the bracket on the compressor.
Set the compressor near the tyre in such a way that the sealant bottle is upright.
6. Unscrew valve cap from defective tyre.

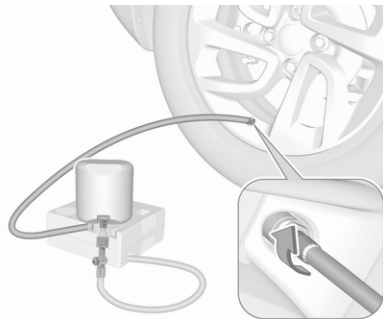

7. Screw the filler hose to the tyre valve.
8. The switch on the compressor must be set to O.
9. Connect the compressor plug to the power outlet ↻ 74.
To avoid discharging the battery, we recommend running the engine.

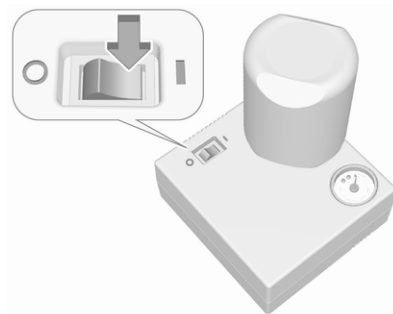

10. Set the rocker switch on the compressor to I. The tyre is filled with sealant.
11. The compressor pressure gauge briefly indicates up to 6 bar whilst the sealant bottle is emptying (approx. 30 seconds). Then the pressure starts to drop.
12. All of the sealant is pumped into the tyre. Then the tyre is being inflated.
13. The prescribed tyre pressure should be obtained within 10 minutes.
Tyre pressure ↻ 232.

When the correct pressure is obtained, switch off the compressor.

If the prescribed tyre pressure is not obtained within 10 minutes, remove the tyre repair kit. Move the vehicle one tyre rotation.

Reattach the tyre repair kit and continue the filling procedure for 10 minutes. If the prescribed tyre pressure is still not obtained, the tyre is too badly damaged. Seek the assistance of a workshop.

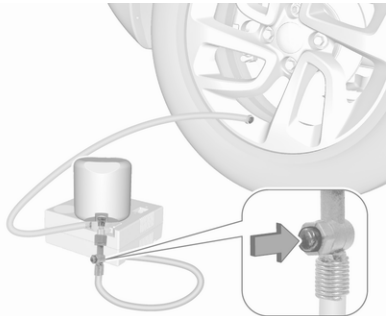

Drain excess tyre pressure with the button on the air hose.

Do not run the compressor longer than 10 minutes.

14. Detach the tyre repair kit. Remove sealant bottle from bracket. Screw the filler hose to the free connection of the sealant bottle. This prevents sealant from escaping. Stow tyre repair kit in load compartment.
15. Remove any excess sealant using a cloth.

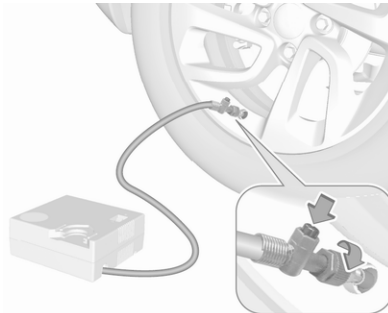

16. Continue driving immediately so that sealant is evenly distributed in the tyre. After driving approx. 3 miles (but no more than 10 min), stop and check tyre pressure. Screw compressor air hose directly onto tyre valve when doing this. Fill tyre as described

before. Drain excess tyre pressure with the button on the air hose.

If tyre pressure hasn't decreased under 1.5 bar, set it to the correct value. Otherwise the vehicle must not be used. Seek assistance of a workshop.

Repeat the checking procedure once more after driving further 6 miles (but no more than 10 minutes) to check that there is no more loss of pressure.

If the tyre pressure has fallen below 1.5 bar, the vehicle must not be used. Seek the assistance of a workshop.

17. Stow away tyre repair kit in load compartment.

Notice

The driving characteristics of the repaired tyre are severely affected, therefore have this tyre replaced.

If unusual noise is heard or the compressor becomes hot, turn compressor off for at least 30 minutes.

The built-in safety valve opens at a pressure of 7 bar (102 psi).

Note the expiry date of the kit. After this date its sealing capability is no longer guaranteed. Pay attention to storage information on sealant bottle.

Replace the used sealant bottle. Dispose of the bottle as prescribed by applicable laws.

The compressor and sealant can be used from approx. -30 °C.

Wheel changing

Make the following preparations and observe the following information:

- Park the vehicle on a level, firm and non-skid surface. The front wheels must be in the straight-ahead position.
- If necessary, place a chock under the wheel diagonally opposite the wheel to be changed.
- Apply the parking brake and engage first gear, reverse gear or P.

- If the ground on which the vehicle is standing is soft, a solid board (max. 1 cm thick) should be placed under the jack.
- Take heavy objects out of the vehicle before jacking up.
- No people or animals may be in the vehicle when it is jacked-up.
- Never crawl under a jacked-up vehicle.
- Do not start the vehicle when it is raised on the jack.
- Before screwing in the wheel bolts, clean them.

Warning

Do not grease wheel bolts.

Tightening torques

Caution

If the vehicle is equipped with alloy wheels, tighten the wheel bolts manually at least for the first five turns.

There are two different types of wheels with two different bolts and tightening torques.

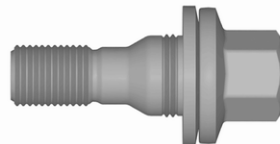

Tightening torque for alloy wheels is 100 Nm.



Tightening torque for steel wheels is 115 Nm.

Warning

Ensure to use always the correct wheel bolts if changing the wheels. When installing the spare wheel, the bolts for alloy wheels can also be used.

Jacking positions

The jacking positions shown refer to the use of lifting arms and accessory jacks used for changing winter / summer tyres.



Rear arm position of the lifting platform centrally under the relevant vehicle jacking point.



Front arm position of the lifting platform centrally under the relevant vehicle jacking point.

Spare wheel

The spare wheel can be classified as a temporary spare wheel depending on the size compared to the other mounted wheels and country regulations. In this case a permissible maximum speed applies, even though no label at the spare wheel indicates this.

Caution

The use of a spare wheel that is smaller than the other wheels or in combination with winter tyres could affect driveability. Have the defective tyre replaced as soon as possible.

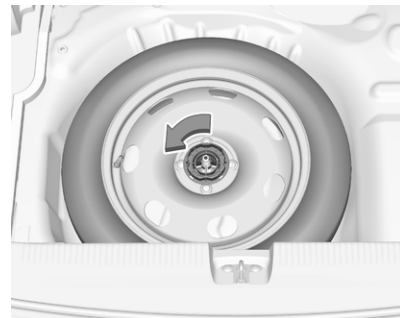

The spare wheel is located in the load compartment:

1. Open the floor cover.
2. The spare wheel is secured with a wing nut. Unscrew nut and take out the spare wheel.

There is a box with tools in the right wall of the load compartment.

Vehicle tools ⇨ 198.

- When, after a wheel change, no wheel is placed in the spare wheel well, fasten the wing nut and close the floor cover.
- After a wheel change back to a full size wheel, place the spare wheel outside up in the well and secure with the wing nut.

Temporary spare wheel

Caution

If driving with a temporary spare wheel, active emergency braking has to be deactivated.

Only mount one temporary spare wheel. The permissible maximum speed on the label on the temporary spare wheel is only valid for the factory-fitted tyre size.

Do not drive faster than 50 mph. Take curves slowly. Do not use for a long period of time.

Fitting the spare wheel

Make the preparations given for wheel changing ⇨ 206 and observe the following information:

- Never change more than one wheel at once.
 - Use the jack only to change wheels in case of puncture, not for seasonal winter or summer tyre change.
 - The jack is maintenance-free.
- Disengage wheel bolt caps with a screwdriver and remove.

Steel wheels with cover: Pull off the wheel cover.

Alloy wheels: Disengage wheel bolt caps with a screwdriver and remove. To protect the wheel, place a soft cloth between the screwdriver and the alloy wheel.

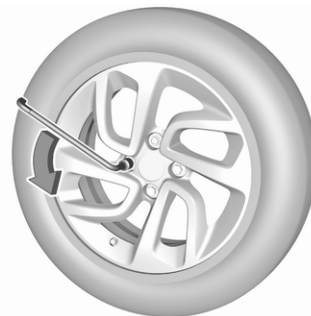

- Attach the wheel wrench and loosen each wheel bolt by half a turn.

The wheels might be protected by locking wheel bolts. To loosen these specific bolts, first attach the adapter for the locking wheel bolts onto the head of the bolt before installing the wheel wrench. The adapter is located in the glovebox or in the load compartment under the rear floor cover.



3. Ensure the jack is correctly positioned under the relevant vehicle jacking point.

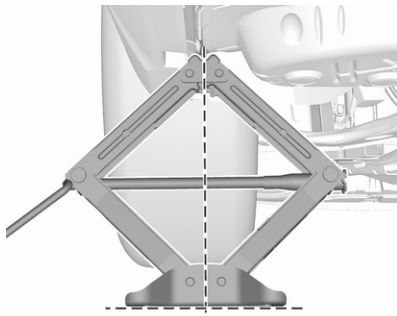

4. Set the jack to the necessary height. Position it directly below

the jacking point in a manner that prevents it from slipping.

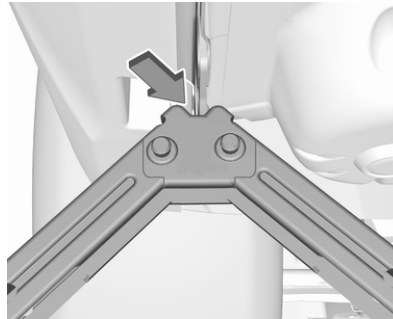

Ensure that the edge of the body fits into the notch of the jack.



With the jack correctly aligned rotate wheel wrench until wheel is clear of the ground.

5. Unscrew the wheel nuts.
6. Change the wheel.
7. Screw on the wheel nuts.
8. Lower the vehicle and remove jack.
9. Install the wheel wrench ensuring that it is located securely and tighten each bolt in a crosswise sequence. Tightening torque is 100 Nm.

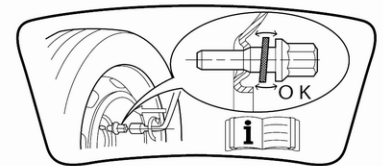

If the vehicle is equipped with alloy wheels, note that the wheel bolts can also be used for the steel

spare wheel. In this case, the spare wheel is secured by the conical contact of each bolt. In this case, the washers do not come into contact with the spare wheel.

10. Align the valve hole in the wheel cover with the tyre valve before installing.

Install wheel nut caps.

11. Stow and secure the replaced wheel and the tools.
12. Check the tyre pressure of the installed tyre and the tightening torque as soon as possible.

Stowing a damaged full size wheel in the load compartment

The spare wheel well is not designed for other tyre sizes than the temporary spare wheel. A damaged full size wheel must be stowed in the load compartment and secured with a strap.

Vehicle tools ⇨ 198.

To secure the wheel:

1. Position the wheel outside up close to one sidewall of the load compartment.

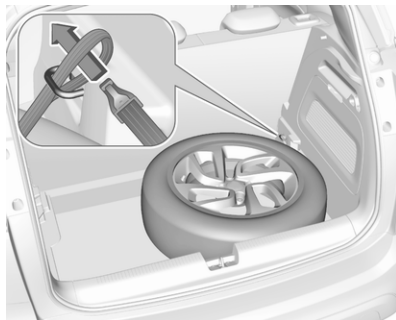

2. Place the loop end of the strap through the front lashing eye on the appropriate side.
3. Place the hook end of the strap through the loop and pull it until the strap is fastened securely to the lashing eye.



4. Insert the strap through the spokes of the wheel as shown in the illustration.
5. Mount the hook to the rear lashing eye.
6. Tighten the strap and secure it using the buckle.

If no strap is available, make sure to store the wheel securely in the load compartment.

Loading information ⇨ 67

⚠ Danger

Always drive with folded up and engaged rear seat backrests when stowing a damaged full size wheel in the load compartment.

Jump starting

Do not start with quick charger.

A vehicle with a discharged vehicle battery can be started using jump leads and the vehicle battery of another vehicle.

⚠ Warning

Be extremely careful when starting with jump leads. Any deviation from the following instructions can lead to injuries or damage caused by battery explosion or damage to the electrical systems of both vehicles.

⚠ Warning

Avoid contact of the battery with eyes, skin, fabrics and painted surfaces. The fluid contains sulphuric acid which can cause injuries and damage in the event of direct contact.

- Never expose the vehicle battery to naked flames or sparks.

- A discharged vehicle battery can already freeze at a temperature of 0 °C. Defrost the frozen battery before connecting jump leads.
- Wear eye protection and protective clothing when handling a battery.
- Use a booster battery with the same voltage (12 V). Its capacity (Ah) must not be much less than that of the discharged vehicle battery.
- Use jump leads with insulated terminals and a cross section of at least 16 mm² (25 mm² for diesel engines).
- Do not disconnect the discharged vehicle battery from the vehicle.
- Switch off all unnecessary electrical consumers.
- Do not lean over the vehicle battery during jump starting.
- Do not allow the terminals of one lead to touch those of the other lead.

- The vehicles must not come into contact with each other during the jump starting process.
- Apply the parking brake, transmission in neutral, automatic transmission in **P**.

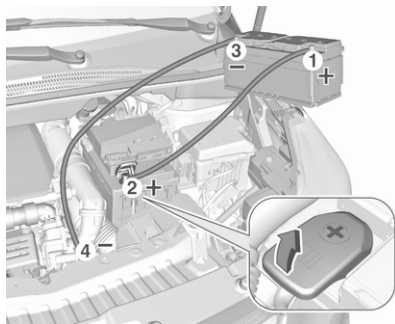

Open the positive terminal protection caps of both vehicle batteries.

Lead connection order:

1. Connect the red lead to the positive terminal of the booster battery.
2. Connect the other end of the red lead to the positive terminal of the discharged battery.

3. Connect the black lead to the negative terminal of the booster battery.
4. Connect the other end of the black lead to a vehicle grounding point of your vehicle in the engine compartment.

Route the leads so that they cannot catch on rotating parts in the engine compartment.

To start the engine:

1. Start the engine of the vehicle providing the jump.
2. After 5 minutes, start the other engine. Start attempts should be made for no longer than 15 seconds at an interval of 1 minute.
3. Allow both engines to idle for approx. 3 minutes with the leads connected.
4. Switch on electrical consumers (e.g. headlights, heated rear window) of the vehicle receiving the jump start.
5. Reverse above sequence exactly when removing leads.

Towing

Towing the vehicle



Wrap a cloth around the tip of a flat screwdriver to prevent paint damage. Insert a screwdriver in the slot at the bottom of the cap. Release the cap by carefully moving the screwdriver downwards.

The towing eye is stowed with the vehicle tools ⇨ 198.

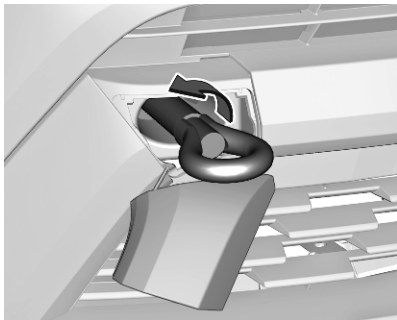

Screw in the towing eye as far as it will go until it stops in a horizontal position.

Attach a tow rope – or better still a tow rod – to the towing eye.

The towing eye must only be used for towing and not for recovering the vehicle.

Switch on ignition to release steering wheel lock and to permit operation of brake lights, horn and windscreen wiper.

Caution

Deactivate the driver assistance systems like active emergency braking ⇨ 151, otherwise the vehicle may automatically brake during towing.

Switch the selector lever to neutral.
Release the parking brake.

Caution

Drive slowly. Do not drive jerkily. Excessive tractive force can damage the vehicle.

When the engine is not running, considerably more force is needed to brake and steer.

To prevent the entry of exhaust gases from the towing vehicle, switch on the air recirculation and close the windows.

Vehicles with automatic transmission: The vehicle must be towed facing forwards, not faster than 50 mph nor further than 60 miles. In all other

cases and when the transmission is defective, the front axle must be raised off the ground.

Seek the assistance of a workshop.

After towing, unscrew the towing eye.

Insert cap with the outer flange into the recess and fix cap by pushing.

Towing another vehicle

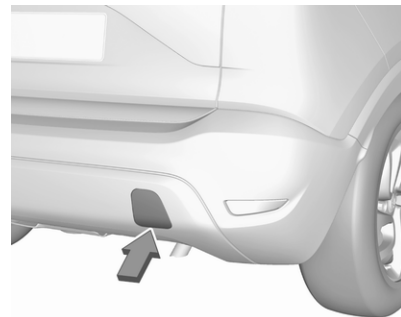

Wrap a cloth around the tip of a flat screwdriver to prevent paint damage. Insert a screwdriver in the slot at the bottom of the cap. Release the cap by carefully moving the screwdriver downwards.

The towing eye is stowed with the vehicle tools ⇨ 198.



Screw in the towing eye as far as it will go until it stops in a horizontal position.

The lashing eye at the rear underneath the vehicle must never be used as a towing eye.

Attach a tow rope – or better still a tow rod – to the towing eye.

The towing eye must only be used for towing and not for recovering a vehicle.

Caution

Drive slowly. Do not drive jerkily. Excessive tractive force can damage the vehicle.

After towing, unscrew the towing eye. Insert cap with the upper flange into the recess and fix cap by pushing.

Appearance care

Exterior care

Locks

The locks are lubricated at the factory using a high quality lock cylinder grease. Use a de-icing agent only when absolutely necessary, as this has a degreasing effect and impairs lock function. After using a de-icing agent, have the locks regreased by a workshop.

Washing

The paintwork is exposed to environmental influences.

Bird droppings, dead insects, resin, pollen and the like should be cleaned off immediately, as they contain aggressive constituents which can cause paint damage.

If using a vehicle wash, comply with the vehicle wash manufacturer's instructions. The windscreen wiper and rear window wiper must be

switched off. Remove antenna and external accessories such as roof racks etc.

If the vehicle is washed by hand, make sure that the insides of the wheel housings are also thoroughly rinsed out.

Wax painted parts of the vehicle regularly.

Clean edges and folds on opened doors and the bonnet as well as the areas they cover.

Clean bright metal mouldings with a cleaning solution approved for aluminium to avoid damages.

Caution

Always use a cleaning agent with a pH value of four to nine.
Do not use cleaning agents on hot surfaces.

Do not clean the engine compartment with a steam-jet or high-pressure jet cleaner.

Thoroughly rinse and leather-off the vehicle. Rinse leather frequently. Use separate leathers for painted and glass surfaces: remnants of wax on the windows will impair vision.

Have the door hinges of all doors greased by a workshop.

Do not use hard objects to remove spots of tar. Use tar removal spray on painted surfaces.

Exterior lights

Headlight and other light covers are made of plastic. Do not use any abrasive or caustic agents, do not use an ice scraper, and do not clean them dry.

Polishing and waxing

Polishing is necessary only if the paint has become dull or if solid deposits have become attached to it.

Plastic body parts must not be treated with wax or polishing agents.

Windows and windscreen wiper blades

Switch off wipers before handling in their areas.

Use a soft lint-free cloth or chamois leather together with window cleaner and insect remover.

When cleaning the rear window from inside, always wipe in parallel to the heating element to prevent damage.

For mechanical removal of ice, use a sharp-edged ice scraper. Press the scraper firmly against the glass so that no dirt can get under it and scratch the glass.

Clean smearing wiper blades with a soft cloth and window cleaner. Also make sure to remove any residues such as wax, insect residues and similar from the window.

Ice residues, pollution and continuous wiping on dry windows will damage or even destroy the wiper blades.

Glass panel

Use a soft lint-free cloth or chamois leather together with window cleaner to clean the glass panel.

Wheels and tyres

Do not use high-pressure jet cleaners.

Clean rims with a pH-neutral wheel cleaner.

Rims are painted and can be treated with the same agents as the body.

Paintwork damage

Rectify minor paintwork damage with a touch-up pen before rust forms. Have more extensive damage or rust areas repaired by a workshop.

Underbody

Some areas of the vehicle underbody have a PVC undercoating while other critical areas have a durable protective wax coating.

After the underbody is washed, check the underbody and have it waxed if necessary.

Bitumen / rubber materials could damage the PVC coating. Have underbody work carried out by a workshop.

Before and after winter, wash the underbody and have the protective wax coating checked.

Towing equipment

Do not clean the coupling ball bar with a steam-jet or high-pressure jet cleaner.

Interior care

Interior and upholstery

Only clean the vehicle interior, including the instrument panel fascia and panelling, with a dry cloth or interior cleaner.

Clean the leather upholstery with clear water and a soft cloth. In case of heavy soiling, use leather care.

The instrument cluster and the displays should only be cleaned using a soft damp cloth. If necessary use a weak soap solution.

Clean fabric upholstery with a vacuum cleaner and brush. Remove stains with an upholstery cleaner.

Clothing fabrics may not be colourfast. This could cause visible discolourations, especially on light-coloured upholstery. Removable stains and discolourations should be cleaned as soon as possible.

Clean seat belts with lukewarm water or interior cleaner.

Caution

Close Velcro fasteners as open Velcro fasteners on clothing could damage seat upholstery.

The same applies to clothing with sharp-edged objects, like zips or belts or studded jeans.

Plastic and rubber parts

Plastic and rubber parts can be cleaned with the same cleaner as used to clean the body. Use interior cleaner if necessary. Do not use any other agent. Avoid solvents and petrol in particular. Do not use high-pressure jet cleaners.

Floor mats

⚠ Warning

If a floor mat has the wrong size or is not properly installed, it can interfere with the accelerator pedal and/or brake pedal, what can cause unintended acceleration and/or increased stopping distance which can cause a crash and injury.

Use the following guidelines for proper floor mat usage.

- The original equipped floor mats were designed for your vehicle. Have damaged floor mats only

replaced by certified floor mats. Always check that the floor mats do not interfere with the pedals.

- Use the floor mat with the correct side up. Do not turn it over.
- Do not place anything on top of the driver's side floor mat.
- Use only a single floor mat on the driver's side.

Installing and removing the floor mats

The driver's side floor mat and the passenger's side floor mat are each held in place by two retainers.

To install the floor mat:

1. Move the seat backwards as far as possible.

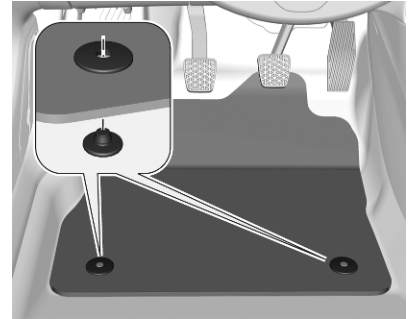

2. Align slots in the mat with the retainers, as shown.
3. Push the mat to the floor.

To remove the floor mat:

1. Move the seat backwards as far as possible.
2. Pull the floor mat upwards to remove.

Service and maintenance

General information	218
Service information	218
Recommended fluids, lubricants and parts	222
Recommended fluids and lubricants	222

General information

Service information

In order to ensure economical and safe vehicle operation and to maintain the value of your vehicle, it is of vital importance that all maintenance work is carried out at the proper intervals as specified.

The detailed, up-to-date service schedule for your vehicle is available at the workshop.

Severe operating conditions exist if one or more of the following circumstances occur frequently: Cold starting, stop and go operation, e.g. for taxis and police vehicles, trailer operation, mountain driving, driving on poor and sandy road surfaces, increased air pollution, presence of airborne sand and high dust content, driving at high altitude and large variations of temperature.

Under these severe operating conditions, certain service work may be required more frequently than the regular service interval indicated in the service display. Contact a workshop for customised service schedules.

Service display ⇨ 81.

Confirmations

Confirmation of service is recorded in the Service and warranty booklet. The date and mileage is completed with the stamp and signature of the servicing workshop.

Make sure that the Service and warranty booklet is completed correctly as continuous proof of service is essential if any warranty or goodwill claims are to be met, and is also a benefit when selling the vehicle.

Service intervals

Engine code	EB2ADT EB2ADTS	EB2FA	EP6FADTXD	EB2DTS	EP6FDTMD EP6FDTM
Country group 1	12,000 miles / 1 year	12,000 miles / 1 year	19,000 miles / 1 year		
Country group 2	9,000 miles / 1 year	12,000 miles / 1 year	12,000 miles / 1 year		
Country group 3	9,000 miles / 1 year	12,000 miles / 1 year	12,000 miles / 1 year	6,000 miles / 1 year ¹⁾	
Country group 4		9,000 miles / 1 year	12,000 miles / 1 year		12,000 miles / 1 year
Country group 5		6,000 miles / 1 year			6,000 miles / 1 year

1) Unless otherwise indicated in the service display.

220 Service and maintenance

Engine code	DV5RC DV5RD DV5RCD DV5RCE	DW10FC	DV6D
Country group 1	19,000 miles / 1 year ¹⁾	19,000 miles / 1 year ¹⁾	
Country group 2	19,000 miles / 1 year ¹⁾	19,000 miles / 1 year ¹⁾	
Country group 3	9,000 miles / 1 year	12,000 miles / 1 year	
Country group 4	9,000 miles / 1 year	12,000 miles / 1 year	9,000 miles / 1 year
Country group 5	6,000 miles / 1 year	6,000 miles / 1 year	6,000 miles / 1 year

1) Unless otherwise indicated in the service display.

Country Group 1:

Andorra, Austria, Belgium, Cyprus, Denmark, Finland, France, Germany, Greece, Iceland, Republic of Ireland, Italy, Liechtenstein, Luxembourg, Malta, Monaco, Netherlands, Norway, Portugal, San Marino, Spain, Sweden, Switzerland, United Kingdom.

Country Group 2:

Bosnia-Herzegovina, Bulgaria, Croatia, Czech Republic, Estonia, North Macedonia, Hungary, Latvia, Lithuania, Poland, Romania, Slovakia, Slovenia.

Country Group 3:

Albania, Montenegro, Serbia.

Country Group 4:

Israel, South Africa, Turkey, Lesotho, Swaziland.

Country Group 5:

All other countries which are not listed in the previous country groups.

Confirmations

Confirmation of service is recorded in the Service and warranty booklet. The date and mileage is completed with the stamp and signature of the servicing workshop.

Make sure that the Service and warranty booklet is completed correctly as continuous proof of service is essential if any warranty or goodwill claims are to be met, and is also a benefit when selling the vehicle.

Recommended fluids, lubricants and parts

Recommended fluids and lubricants

Only use products that meet the recommended specifications.

Warning

Operating materials are hazardous and could be poisonous. Handle with care. Pay attention to information given on the containers.

Engine oil

Engine oil is identified by its quality and its viscosity. Quality is more important than viscosity when selecting which engine oil to use. The engine oil quality ensures e.g. engine cleanliness, wear protection and engine oil aging control, whereas viscosity grade gives information on the engine oil's thickness over a temperature range.

Select the appropriate engine oil based on its quality and on the minimum ambient temperature ⇨ 226.

Topping up engine oil

Caution

In case of any spilled engine oil, wipe it up and dispose of it properly.

Engine oils of different manufacturers and brands can be mixed as long as they comply with the required engine oil quality and viscosity.

Select the appropriate engine oil based on its quality and on the minimum ambient temperature ⇨ 226.

Additional engine oil additives

The use of additional engine oil additives could cause damage and invalidate the warranty.

Engine oil viscosity grades

The SAE viscosity grade gives information of the thickness of the engine oil.

Multigrade engine oil is indicated by two figures, e.g. SAE 5W-30. The first figure, followed by a W, indicates the low temperature viscosity and the second figure the high temperature viscosity.

Select the appropriate viscosity grade depending on the minimum ambient temperature ⇨ 226.

All of the recommended viscosity grades are suitable for high ambient temperatures.

Coolant and antifreeze

Use only Lobrid antifreeze approved for the vehicle. Consult a workshop.

The system is factory filled with coolant designed for excellent corrosion protection and frost protection down to approx. -37 °C. This concentration should be maintained all year round. The use of additional coolant additives that

intend to give additional corrosion protection or seal against minor leaks can cause function problems. Liability for consequences resulting from the use of additional coolant additives will be rejected.

Washer fluid

Use only washer fluid approved for the vehicle to prevent damage of wiper blades, paintwork, plastic and rubber parts. Consult a workshop.

Brake fluid

Over time, brake fluid absorbs moisture which will reduce braking effectiveness. The brake fluid should therefore be replaced at the specified interval.

AdBlue

Only use AdBlue to reduce the nitrogen oxides in the exhaust emission ↪ 131.

Technical data

Vehicle identification	224
Vehicle identification number ..	224
Identification plate	224
Engine identification	225
Vehicle data	226
Recommended fluids and lubricants	226
Engine data	228
Performance	229
Vehicle dimensions	231
Capacities	232
Tyre pressures	233

Vehicle identification

Vehicle identification number

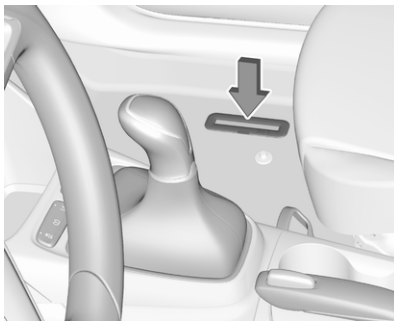

The vehicle identification number is stamped on the identification plate and on the floor pan, under the floor covering, visible under a cover.

The vehicle identification number may be embossed on the instrument panel, visible through the windscreen, or in the engine compartment on the right body panel.

Identification plate



The identification plate is located on the front left or right door frame.

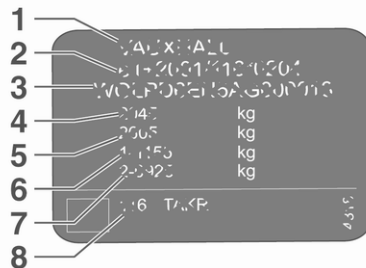

Information on identification label:

- 1 : manufacturer
- 2 : type approval number
- 3 : vehicle identification number
- 4 : permissible gross vehicle weight rating in kg
- 5 : permissible gross train weight in kg
- 6 : maximum permissible front axle load in kg
- 7 : maximum permissible rear axle load in kg
- 8 : vehicle-specific or country-specific data

The combined total of front and rear axle loads must not exceed the permissible gross vehicle weight.

Vehicle's kerb weight depends on the specification of the vehicle, e.g. optional equipment and accessories. Refer to the EEC Certificate of Conformity provided with your vehicle or other national registration documents.

The technical data is determined in accordance with European Community standards. We reserve the right to make modifications.

Specifications in the vehicle documents always have priority over those given in this manual.

Engine identification

The technical data tables use the engine identifier code. The engine data table additionally shows the engineering code.

Engine data ⇨ 228.

To identify the respective engine, refer to the EEC Certificate of Conformity provided with this vehicle or other national registration documents.

The Certificate of Conformity shows the engine identifier code, other national publications may show the engineering code. Check piston displacement and engine power to identify the respective engine.

Vehicle data

Recommended fluids and lubricants

Required engine oil quality

Country groups ↗ 218

Countries included in country groups 1 to 3

EB2FA	
EB2ADT	EP6FDTM
EB2ADTD	EB2DT
EB2ADTS	EC5F
EP6FADTXD	DW10FC
DV5RC	DV6D
DV5RD	DV6FD
DV5RE	DV6FE

Vauxhall Original engine oil

B71 2010 / B71 2312

B71 2312

Engine EC5F: B71 2290, B71 2296 or B71 300 may also be used.

Countries included in country group 4

all engines

Vauxhall Original engine oil

B71 2302 / B71 2297

Engine EC5F: B71 2296 or B71 300 may also be used.

Countries included in country group 5

all engines

Vauxhall Original engine oil

B71 2297

Engine oil viscosity grades

Country groups ↗ 218

	B71 2010	B71 2312	B71 2302	B71 2297
Engine oil viscosity grade	SAE 0W-20	SAE 0W-30	SAE 0W-30	SAE 5W-30

Engine data

Engine identifier code	D12xE / F12xE	D12xHL / F12xHL	D12xHT / F12xHT
Sales designation	1.2	1.2 Turbo	1.2 Turbo
Engineering code	EB2FA	EB2DT / EB2ADT	EB2ADTS
Piston displacement [cm ³]	1199	1199	1199
Engine power [kW]	61	81	96
at rpm	5750	5500	5500
Torque [Nm]	118	205	230
at rpm	2750	1750	1750
Fuel type	Petrol	Petrol	Petrol
Octane rating RON ¹⁾²⁾			
recommended	95	95	95
possible	98	98	98
possible	–	–	–

1) A country-specific label at the fuel filler flap can supersede the engine-specific requirement.

2) In certain countries, the use of a particular fuel, e.g. a specific octane rating, may be required to ensure proper engine operation.

	D15DTH	F15DTH	F15DTH	A16DT Z16DT	D15DT
Engine identifier code					
Sales designation	1.5	1.5	1.5	1.6	1.5
Engineering code	DV5RC	DV5RCD	DV5RCE	DV6D	DV5RD
Piston displacement [cm ³]	1499	1499	1499	1560	1499
Engine power [kW]	88	88	81	68	75
at rpm	3750	3750	3750	4000	3500
Torque [Nm]	300	300	250	230	250
at rpm	1750	1750	1750	1750	1750
Fuel type	Diesel	Diesel	Diesel	Diesel	Diesel

Performance

Engine	D12xE / F12xE	D12xHL / F12xHL	D12xHT / F12xHT
Maximum speed [mph]			
Manual transmission	106	116	125
Automatic transmission	–	116	–

230 Technical data

Engine	D15DT	D15DTH	F15DTH	A16DT / Z16DT
Maximum speed [mph]				
Manual transmission	111	–	111	106
Automatic transmission	–	113	113	–

Vehicle dimensions

Length [mm]	4212
Width with two exterior mirrors [mm]	1976
Width with two exterior mirrors folded [mm]	1825
Height [mm]	1597
Length of load compartment floor [mm]	793
Length of load compartment with folded rear seats [mm]	1483
Load compartment width [mm]	947
Load compartment height with cover [mm]	584
Load compartment height without cover [mm]	894
Height of load compartment opening [mm]	712
Turning circle diameter [m]	11.2

Capacities

Engine oil

Engine	D12xE / F12xE	D12xHL / F12xHL D12xHT / F12xHT	D15DT A16DT / Z16DT	D15DTH F15DTH
including filter [l]	3.25	3.5	3.75	3.95
between MIN and MAX [l]	1.0	1.0	1.0	1.6

Fuel tank

Petrol / diesel, refilling quantity [l]				45
---	--	--	--	----

AdBlue tank

AdBlue, refilling quantity [l]				14.8
--------------------------------	--	--	--	------

Tyre pressures

Tyres	Comfort with up to 3 people		ECO with up to 3 people		With full load	
	front	rear	front	rear	front	rear
	[kPa/bar] ([psi])	[kPa/bar] ([psi])	[kPa/bar] ([psi])	[kPa/bar] ([psi])	[kPa/bar] ([psi])	[kPa/bar] ([psi])
195/65 R15, 195/60 R16	230/2.3 (33)	230/2.3 (33)	250/2.5 (36)	250/2.5 (36)	240/2.4 (35)	290/2.9 (42)
205/60 R16, 215/50 R17	230/2.3 (33)	230/2.3 (33)	250/2.5 (36)	250/2.5 (36)	240/2.4 (35)	270/2.7 (39)
Temporary spare wheel 125/80 R16	420/4.2 (60)	420/4.2 (60)	–	–	420/4.2 (60)	420/4.2 (60)

Customer information

Customer information	234
Declaration of conformity	234
REACH	235
Software update	235
Registered trademarks	236
Vehicle data recording and privacy	237
Event data recorders	237
Radio Frequency Identification (RFID)	240

Customer information

Declaration of conformity

Transmission systems

This vehicle has systems that transmit and / or receive radio waves subject to Directive 2014/53/EU. The manufacturers of the systems listed below declare conformity with Directive 2014/53/EU. The full text of the EU declaration of conformity for each system is available at the following internet address: www.opel.com/conformity.

Importer is
Opel / Vauxhall, Bahnhofspatz,
65423 Ruesselsheim am Main,
Germany.

Navi 5.0 IntelliLink

Continental

LCIE Bureau Veritas-Site de
Fontenay aux Roses, 33 avenue du
général Leclerc, 92260 Fontenay aux
Roses, France

Operation frequency (MHz)	Maximum output (dBm)
---------------------------	----------------------

2400.0 - 2483.5	2.2
-----------------	-----

2400.0 - 2483.5	15
-----------------	----

Infotainment system R 4.0 IntelliLink

LG Electronics

European Shared Service center B.V.
Krijgsman 1, 1186 DM Amstelveen,
The Netherlands

Operation frequency:
2400.0 - 2483.5 MHz

Maximum output: 4 dBm

Infotainment system R 4.0

Clarion

244 rue du Pré à Varois, 54670
Custines, France

Operation frequency:
2400 - 2480 MHz

Maximum output: 4 dBm

BTA Module

Magneti Marelli S.p.A.

Viale A. Borletti 61/63, 20011
Corbetta, Italy

Operation frequency (MHz)	Maximum output (dBm)
880 -915	33
1710 - 1785	24
1850 -1910	24
1920 - 1980	24
2500 - 2570	23

Antenna module

Laird

Daimlerring 31, 31135 Hildesheim, Germany

Operation frequency: N/A

Maximum output: N/A

Radio remote control transmitter

Hülsbeck & Fürst GmbH & Co. KG
Steeger Str. 17, 42551 Velbert, Germany

Operation frequency: 433.92 MHz

Maximum output: 10 dBm

Radio remote control receiver

Delphi European, Middle Eastern & African Regional Offices Customer Technology

Center Avenue de Luxembourg,
L-4940 Bascharage, G.D. of Luxembourg

Operation frequency:
119.0 - 128.6 kHz

Maximum output: 16dB μ A/m @ 10m

Electronic key transmitter

Valeo

43 Rue Bayen, 75017 Paris, France

Operation frequency: 433.92 MHz

Maximum output: 10 dBm

Immobiliser

KOSTAL of America, Inc.

350 Stephenson Hwy, Troy MI 48083, USA

Operation frequency: 125 kHz

Maximum output: 5 dB μ A/m at 10m

ICASA type approval numbers

List of all Independent Communications Authority of South Africa (ICASA) type approval numbers:

TA-2016/121, TA-2016/3261, TA-2017/2387, TA-2017/2745, TA-2013/430, TA-2017/1106, TA-2016/929, TA-2017/3180

REACH

Registration, Evaluation, Authorisation and Restriction of Chemicals (REACH) is a European Union regulation adopted to improve the protection of human health and the environment from the risks that can be posed by chemicals. Visit www.opel.com/reach for further information and for access to the Article 33 communication.

Software update

The Infotainment system can download and install selected software updates over a wireless connection.

Notice

The availability of these over-the-air vehicle software updates varies by vehicle and country. Find more information on our home page.

Internet connection

Downloading over-the-air vehicle software updates requires internet connectivity, which can be accessed through a password-protected Wi-Fi hotspot, e.g. provided by a mobile phone.

To connect the Infotainment system to a hotspot, refer to the Infotainment Manual.

Updates

The system will prompt for certain updates to be downloaded and installed. There is also an option to check for updates manually.

To manually check for updates, select **Settings** on the home screen, **Software Information** and then **System Update**. Follow the on-screen prompts.

Notice

Steps for downloading and installing updates may vary by vehicle.

Notice

During the installation process, the vehicle may not be operational.

Registered trademarks**Apple Inc.**

Apple CarPlay™ is a trademark of Apple Inc.

App Store® and iTunes Store® are registered trademarks of Apple Inc.

iPhone®, iPod®, iPod touch®, iPod nano®, iPad® and Siri® are registered trademarks of Apple Inc.

Bluetooth SIG, Inc.

Bluetooth® is a registered trademark of Bluetooth SIG, Inc.

DivX, LLC

DivX® and DivX Certified® are registered trademarks of DivX, LLC.

EnGIS Technologies, Inc.

BringGo® is a registered trademark of EnGIS Technologies, Inc.

Google Inc.

Android™ and Google Play™ Store are trademarks of Google Inc.

Stitcher Inc.

Stitcher™ is a trademark of Stitcher, Inc.

Velcro Companies

Velcro® is a registered trademark of Velcro Companies.

Verband der Automobilindustrie e.V.

AdBlue® is a registered trademark of the VDA.

Vehicle data recording and privacy

Event data recorders

Electronic control units are installed in your vehicle. Control units process data which is received e.g. by vehicle sensors, or which they generate themselves or exchange amongst themselves. Some control units are necessary for the safe functioning of your vehicle, others assist you while you drive (driver assistance systems), while others provide comfort or infotainment functions.

The following contains general information about data processing in the vehicle. You will find additional information as to which specific data is uploaded, stored and passed on to third parties and for what purpose in your vehicle under the key word Data Protection closely linked to the references for the affected functional characteristics in the relevant Owner's Manual or in the general terms of sale. These are also available online.

Operating data in the vehicle

Control units process data for operation of the vehicle.

This data may include:

- vehicle status information (e.g. speed, movement delay, lateral acceleration, wheel rotation rate, "seat belts fastened" display)
- ambient conditions (e.g. temperature, rain sensor, distance sensor)

As a rule such data is transient and is not stored for longer than an operational cycle, and only processed on board the vehicle itself. Often control units include data storage (including the vehicle key). This is used to allow information to be documented temporarily or permanently on vehicle condition, component stress, maintenance requirements and technical events and errors.

Depending on technical equipment levels, the data stored is as follows:

- system component operating states (e.g. fill level, tyre pressure, battery status)
- faults and defects in important system components (e.g. lights, brakes)
- system reactions in special driving situations (e.g. triggering of an airbag, actuation of the stability control systems)
- information on events damaging the vehicle
- for electric vehicles the amount of charge in the high-voltage battery, estimated range

In special cases (e.g. if the vehicle has detected a malfunction), it may be necessary to save data that would otherwise just be volatile.

When you use services (e.g. repairs, maintenance), the operating data saved can be read together with the vehicle identification number and used where necessary. Staff working for the service network (e.g. garages, manufacturers) or third parties (e.g.

breakdown services) can read the data from the vehicle. The same applies to warranty work and quality assurance measures.

Data is generally read via the OBD (On-Board Diagnostics) port prescribed by law in the vehicle. The operating data read documents the technical condition of the vehicle or individual components and assists with fault diagnosis, compliance with warranty obligations and quality improvement. This data, in particular information on component stress, technical events, operator errors and other faults, is transmitted to the manufacturer where appropriate, together with the vehicle identification number. The manufacturer is also subject to product liability. The manufacturer potentially also uses operating data from vehicles for product recalls. This data can also be used to check customer warranty and guarantee claims.

Fault memories in the vehicle can be reset by a service company when carrying out servicing or repairs or at your request.

Comfort and infotainment functions

Comfort settings and custom settings can be stored in the vehicle and changed or reset at any time.

Depending on the equipment level in question, these include

- seat and steering wheel position settings
- chassis and air conditioning settings
- custom settings such as interior lighting

You can input your own data in the infotainment functions for your vehicle as part of the selected features.

Depending on the equipment level in question, these include

- multimedia data such as music, videos or photos for playback in an integrated multimedia system
- address book data for use with an integrated hands-free system or an integrated navigation system

- input destinations
- data on the use of online services

This data for comfort and infotainment functions can be stored locally in the vehicle or be kept on a device that you have connected to the vehicle (e.g. a smartphone, USB stick or MP3 player). Data that you have input yourself can be deleted at any time.

This data can only be transmitted out of the vehicle at your request, particularly when using online services in accordance with the settings selected by you.

Smartphone integration, e.g. Android Auto or Apple CarPlay

If your vehicle is equipped accordingly, you can connect your smartphone or another mobile device to the vehicle so that you can control it via the controls integrated in the vehicle. The smartphone image and sound can be output via the multimedia system in this case. At the same time, specific information is transmitted to your smartphone. Depending on the type of integration,

this includes data such as position data, day / night mode and other general vehicle information. For more information, please see the operating instructions for the vehicle / infotainment system.

Integration allows selected smartphone apps to be used, such as navigation or music playback. No further integration is possible between smartphone and vehicle, in particular active access to vehicle data. The nature of further data processing is determined by the provider of the app used. Whether you can define settings, and if so which ones, is dependent on the app in question and your smartphone's operating system.

Online services

If your vehicle has a radio network connection, this allows data to be exchanged between your vehicle and other systems. The radio network connection is made possible by means of a transmitter device in your vehicle or a mobile device provided by you (e.g. a smartphone). Online functions can be used via this radio network connection. These include online services and applications / apps provided to you by the manufacturer or other providers.

Proprietary services

In the case of the manufacturer's online services, the relevant functions are described by the manufacturer in an appropriate location (e.g. Owner's Manual, the manufacturer's website) and the associated data protection information is provided. Personal data may be used to provide online services. Data exchange for this purpose takes place via a protected connection, e.g. using the manufacturer's IT systems provided for the purpose. Collection,

processing and use of personal data for the purposes of preparation of services take place solely on the basis of legal permission, e.g. in the case of a legally prescribed emergency communication system or a contractual agreement, or by virtue of consent.

You can activate or deactivate the services and functions (which are subject to charges to some extent) and, in some cases, the vehicle's entire radio network connection. This does not include statutory functions and services such as an emergency communication system.

Third party services

If you make use of online services from other providers (third parties), these services are subject to the liability and data protection and usage conditions of the provider in question. The manufacturer frequently has no influence over the content exchanged in this regard.

Therefore, please note the nature, scope and purpose of the collection and use of personal data within the scope of third party services provided by the service provider in question.

Radio Frequency Identification (RFID)

RFID technology is used in some vehicles for functions such as immobiliser. It is also used in connection with conveniences such as radio remote controls for door locking / unlocking and starting. RFID technology in Vauxhall vehicles does not use or record personal information or link with any other Vauxhall system containing personal information.

Index

A

Accessories and vehicle modifications	177
Active emergency braking....	88, 151
AdBlue.....	87, 131, 232
Adjustable air vents	120
Advanced parking assist.....	157
Airbag and belt tensioners	83
Airbag deactivation	54, 83
Airbag label.....	49
Airbag system	49
Air conditioning regular operation	121
Air conditioning system	112
Air intake	121
Air vents.....	120
Antilock brake system	138
Antilock brake system (ABS)	85
Anti-theft alarm system	31
Anti-theft locking system	30
Appearance care.....	214
Armrest.....	44, 45, 62
Ashtrays	76
Automatic anti-dazzle	35
Automatic crash notification (ACN)	99
Automatic light control	103
Automatic locking	28
Automatic transmission	134
Autostop.....	88, 127
Auxiliary heater.....	119

B

Battery discharge protection	110
Belts.....	46
BlueInjection.....	131
Bonnet	179
Brake and clutch system	85
Brake assist	139
Brake fluid	182, 222
Brake light.....	188
Brakes	138, 182
Breakdown.....	212
Bulb replacement	185

C

Capacities	232
Catalytic converter	131
Central locking system	23
Centre console lighting	109
Centre console storage	62
Changing tyre and wheel size ...	202
Charging system	84
Child locks	28
Child restraint installation locations	58
Child restraints.....	55
Child restraint systems	55
Cigarette lighter	76
Climate control	15
Climate control systems.....	111
Clock.....	74

Control indicators.....	82
Control of the vehicle	123
Controls.....	70
Convex shape	33
Coolant and antifreeze.....	222
Cornering lights.....	105
Cruise control	88, 144
Cupholders	61
Curtain airbag system	53

D

Danger, Warnings and Cautions ...	4
Daytime running lights	105
Declaration of conformity.....	234
DEF.....	131
Deflation detection system.....	87
Descent control system	86, 141
Diesel exhaust fluid.....	131
Diesel fuel system bleeding	184
Door open	89
Doors.....	29
Driver alert.....	168
Driver assistance systems.....	144
Driver Information Centre.....	89
Driving characteristics and towing tips	173
Driving hints.....	123

E

Electric adjustment	33
Electrical system.....	193

Electronic climate control system	115
Electronic driving programmes ..	136
Electronic key system.....	22
Electronic Stability Control and Traction Control system....	86, 140
Electronic Stability Control and Traction Control system off.....	86
Emergency call.....	99
End-of-life vehicle recovery	178
Engine compartment fuse box ...	194
Engine coolant	181
Engine coolant temperature	86
Engine coolant temperature gauge	80
Engine data	228
Engine exhaust	130
Engine identification.....	225
Engine oil	180, 222, 226, 232
Engine oil level monitor.....	81
Engine oil pressure	87
Entry lighting	109
ERA GLONASS.....	100
Event data recorders.....	237
Exhaust filter.....	86, 130
Exit lighting	109
Exterior care	214
Exterior light	88
Exterior lighting	12, 102
Exterior mirrors.....	33

F

Fault	136
First aid.....	66
First aid kit	66
Fixed air vents	120
Floor mats.....	217
Folding mirrors	34
Forward collision alert.....	149
Front airbag system	52
Front fog lights	88, 106, 188
Front pedestrian protection.....	153
Front seats.....	41
Fuel.....	169
Fuel for diesel engines	170
Fuel for petrol engines	169
Fuel gauge	80
Fuel tank.....	232
Fuses	193

G

Gauges.....	79
Gear selection	134
Gear shifting.....	85
General information	173
Glass panel	38
Glovebox	61

H

Halogen headlights	185
Hand brake.....	138, 139
Hazard warning flashers	105

- Headlight flash 104
Headlight range adjustment 104
Headlights 102
Headlights when driving abroad 105
Head restraint adjustment 8
Head restraints 40
Head-up display 93
Heated mirrors 34
Heated rear window 37
Heated steering wheel 70
Heated windscreen 38
Heating 44
Heating and ventilation system . 111
High beam 88, 103
High beam assist 88, 103
Hill start assist 139
Horn 13, 71
- I**
- Identification plate 224
Ignition switch positions 124
Immobiliser 33
Indicators 79
Inductive charging 75
Info Display 92
Instrument cluster 77
Instrument panel fuse box 196
Instrument panel illumination
control 108
Instrument panel overview 10
- Interior care 216
Interior lighting 108
Interior lights 108, 193
Interior mirrors 35
Interruption of power supply 136
Introduction 3
- J**
- Jump starting 211
- K**
- Keys 20
Keys, locks 20
- L**
- Lane departure warning 86, 167
Lashing eyes 65
LED headlights 105, 188
Lighting features 109
Light switch 102
Load compartment 29, 62
Load compartment cover 64
Loading information 67
Low beam 88
Low fuel 87
- M**
- Malfunction indicator light 84
Manual anti-dazzle 35
Manual mode 135
Manual transmission 137
- Manual windows 36
Mirror adjustment 9
Misted light covers 107
- N**
- New vehicle running-in 123
Number plate light 193
- O**
- Object detection systems 154
Odometer 79
Oil, engine 222, 226
Outside temperature 73
Overrun cut-off 127
- P**
- Panoramic view system 163
Parking 18, 129
Parking assist 154
Parking brake 85, 139
Parking lights 107
Particulate filter 130
Performance 229
Performing work 179
Power button 124
Power outlets 74
Power windows 36
Preheating 86
Puncture 207

- Q**
 Quickheat..... 119
- R**
 Radio Frequency Identification (RFID)..... 240
 Radio remote control 21
 Rain sensor..... 88
 REACH..... 235
 Reading lights 108
 Rear floor storage cover 64
 Rear fog light 88, 107, 188
 Rear seats 45
 Rear view camera 166
 Rear window wiper and washer . . 73
 Recommended fluids and lubricants 222, 226
 Refuelling 171
 Registered trademarks..... 236
 Reverse light..... 188
 Reversing lights 107
 Ride control systems..... 140
 Roadside assistance..... 99
 Roof..... 38
 Roof load..... 67
 Roof rack 67
- S**
 Safety belts..... 46
 Seat adjustment 7, 42
 Seat belt 8
 Seat belt reminder 83
 Seat belts 46
 Seat heating..... 44
 Seat position 41
 Selective catalytic reduction..... 131
 Selective ride control..... 142
 Selector lever..... 134
 Service 121, 218
 Service display 81
 Service information 218
 Service vehicle soon 84
 Side airbag system 52
 Side blind spot alert..... 88, 161
 Sidelights..... 102
 Side turn lights 192
 Software update..... 235
 SOS..... 99
 Spare wheel 207
 Speed limiter..... 89, 147
 Speedometer 79
 Starting and operating..... 123
 Starting off 16
 Starting the engine 125
 Steering..... 123
 Steering wheel adjustment 9, 70
 Steering wheel controls 70
 Stop engine..... 84
 Stop-start system..... 127
 Storage..... 61
 Storage compartments..... 61
 Sun visor lights 109
 Sun visors 38
 Symbols 4
 System check..... 84
- T**
 Tachometer 80
 Tail lights 188
 Three-point seat belt 47
 Through-loading facility..... 62
 Tools 198
 Tow bar..... 173
 Towing..... 173, 212
 Towing another vehicle 213
 Towing equipment 174
 Towing the vehicle 212
 Trailer hitch..... 173
 Trailer towing 173
 Transmission 16
 Transmission display 134
 Tread depth 201
 Trip odometer 79
 Turn lights 82, 106
 Tyre chains 202
 Tyre deflation detection system . 200
 Tyre designations 199
 Tyre pressure 199
 Tyre pressures 233
 Tyre repair kit 203

U

Ultrasonic parking assist.....	154
Upholstery.....	216
USB port.....	74
Using this manual	3

V

Vauxhall Connect.....	99
Vehicle battery	182
Vehicle checks.....	179
Vehicle data.....	226
Vehicle data recording and privacy.....	237
Vehicle dimensions	231
Vehicle identification number	224
Vehicle jack.....	198
Vehicle messages	95
Vehicle personalisation	96
Vehicle security.....	30
Vehicle specific data	3
Vehicle storage.....	178
Vehicle tools.....	198
Vehicle unlocking	6
Ventilation.....	111

W

Warning chimes	95
Warning lights.....	79
Warning triangle	66
Washer and wiper systems	13
Washer fluid	181

Wheel

Tightening torque.....	207
Wheel changing	206
Wheel covers	202
Wheels and tyres	199
Windows.....	35
Windscreen.....	35
Windscreen wiper and washer	71
Winter tyres	199
Wiper blade replacement	184

Copyright by Vauxhall Motors Ltd.

The information contained in this publication is effective as of the date indicated below. Vauxhall Motors Ltd. reserves the right to make changes to the technical specifications, features and design of the vehicles relative to the information contained in this publication, as well as changes to the publication itself.

Edition: November 2020, Vauxhall Motors Ltd.

Printed on chlorine-free bleached paper.

ID-VCDAORIE2011-en

