

# **VAUXHALL Astra GTC**

**Owner's Manual  
Model Year 2012.5  
Edition: January 2012  
TS 1708-C-12**

---

# Contents

Introduction .....	2
In brief .....	6
Keys, doors and windows .....	19
Seats, restraints .....	33
Storage .....	52
Instruments and controls .....	63
Lighting .....	99
Climate control .....	112
Driving and operating .....	120
Vehicle care .....	155
Service and maintenance .....	197
Technical data .....	200
Customer information .....	217
Index .....	220

## Introduction

Fuel	Designation	<input type="text"/>		
Engine oil	Grade	<input type="text"/>		
	Viscosity	<input type="text"/>		
Tyre pressure	Tyre size		Front	Rear
	Summer tyres	<input type="text"/>	<input type="text"/>	<input type="text"/>
	Winter tyres	<input type="text"/>	<input type="text"/>	<input type="text"/>
Weights	Gross vehicle weight rating	<input type="text"/>		
	- Kerb weight, basic model	<input type="text"/>		
	= Loading	<input type="text"/>		

## Vehicle specific data

Please enter your vehicle's data on the previous page to keep it easily accessible. This information is available in the sections "Service and maintenance" and "Technical data" as well as on the identification plate.

## Introduction

Your vehicle is a designed combination of advanced technology, safety, environmental friendliness and economy.

This Owner's Manual provides you with all the necessary information to enable you to drive your vehicle safely and efficiently.

Make sure your passengers are aware of the possible risk of accident and injury which may result from improper use of the vehicle.

You must always comply with the specific laws and regulations of the country that you are in. These laws may differ from the information in this Owner's Manual.

When this Owner's Manual refers to a workshop visit, we recommend your Vauxhall Authorised Repairer.

All Vauxhall Authorised Repairers provide first-class service at reasonable prices. Experienced mechanics trained by Vauxhall work according to specific Vauxhall instructions.

The customer literature pack should always be kept ready to hand in the vehicle.

## Using this manual

- This manual describes all options and features available for this model. **Certain descriptions, including those for display and menu functions, may not apply to your vehicle due to model variant, country specifications, special equipment or accessories.**
- The "In brief" section will give you an initial overview.
- The table of contents at the beginning of this manual and within each section shows where the information is located.

- The index will enable you to search for specific information.
- This Owner's Manual depicts left-hand drive vehicles. Operation is similar for right-hand drive vehicles.
- The Owner's Manual uses the factory engine designations. The corresponding sales designations can be found in the section "Technical data".
- Directional data, e.g. left or right, or front or back, always relate to the direction of travel.
- The vehicle display screens may not support your specific language.
- Display messages and interior labelling are written in **bold** letters.

## Danger, Warnings and Cautions

### Danger

Text marked  **Danger** provides information on risk of fatal injury. Disregarding this information may endanger life.

**⚠ Warning**

Text marked **⚠ Warning** provides information on risk of accident or injury. Disregarding this information may lead to injury.

**Caution**

Text marked **Caution** provides information on possible damage to the vehicle. Disregarding this information may lead to vehicle damage.

**Symbols**

Page references are indicated with ⇨.  
⇨ means "see page".

Thank you for choosing a Vauxhall.

We wish you many hours of  
pleasurable driving.

**Your Vauxhall Team**



## In brief

### Initial drive information

#### Vehicle unlocking





Press button  to unlock the doors and load compartment. Open the doors by pulling the handles.



To open the tailgate, push the brand emblem at the bottom half.

Press button  to unlock and open the tailgate while the doors remain locked.

Radio remote control  20, Central locking system  21, Load compartment  23.

## Seat adjustment

### Seat positioning

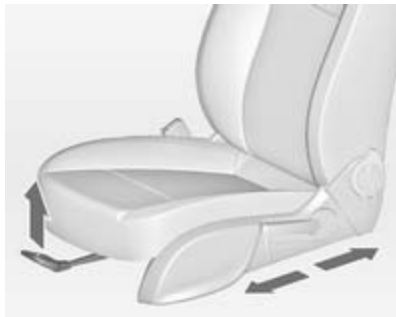

Pull handle, slide seat, release handle.

Seat position ⇄ 35, Seat adjustment ⇄ 35.

### **⚠ Danger**

Do not sit nearer than 25 cm from the steering wheel, to permit safe airbag deployment.

### Seat backrests



Pull lever, adjust inclination and release lever. Allow the seat to engage audibly.

Seat position ⇄ 35, Seat adjustment ⇄ 35, Seat folding ⇄ 38.

### Seat height

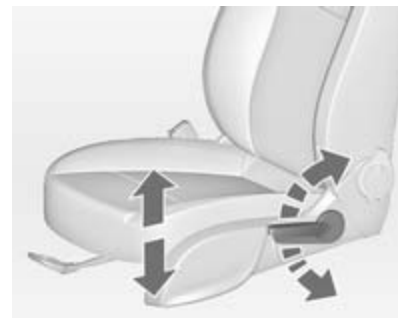

Lever pumping motion

up = seat higher  
down = seat lower

Seat position ⇄ 35, Seat adjustment ⇄ 35.



### Seat inclination

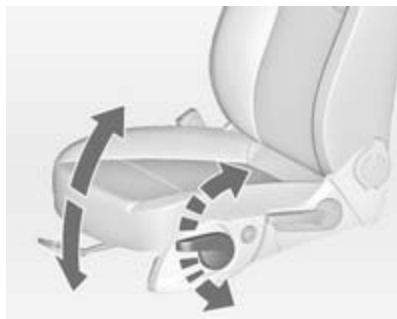

Lever pumping motion

up = front end higher

down = front end lower

Seat position ⇨ 35, Seat adjustment  
⇨ 35.

### Head restraint adjustment

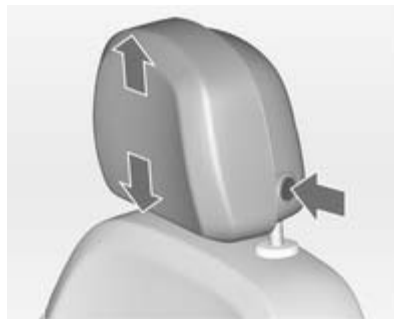

Press the button, adjust height and engage.

Head restraints ⇨ 33.

### Seat belt



Pull out the seat belt and engage in belt buckle. The seat belt must not be twisted and must fit close against the body. The backrest must not be tilted back too far (maximum approx. 25 °).

To release belt, press red button on belt buckle.

Seat position ⇨ 35, Seat belts  
⇨ 40, Airbag system ⇨ 42.

## Mirror adjustment

### Interior mirror

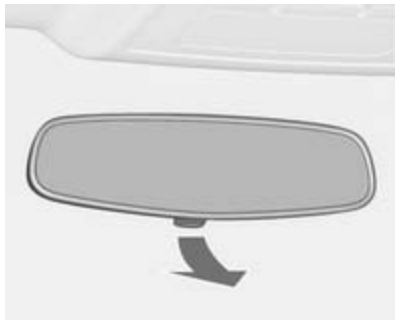

To reduce dazzle, adjust the lever on the underside of the mirror housing.  
Interior mirror ↗ 29, Automatic anti-dazzle interior mirror ↗ 29.

### Exterior mirrors

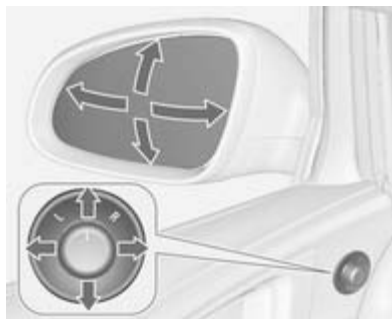

Select the relevant exterior mirror and adjust it.

Convex exterior mirrors ↗ 27,  
Electric adjustment ↗ 27, Folding exterior mirrors ↗ 28, Heated exterior mirrors ↗ 28.

## Steering wheel adjustment



Unlock the lever, adjust the steering wheel, then engage the lever and ensure it is fully locked.

Do not adjust the steering wheel unless the vehicle is stationary and the steering wheel lock has been released.

Airbag system ↗ 42, Ignition positions ↗ 121.

## Instrument panel overview



- 
- |  |     |  |     |   |     |
|--|-----|--|-----|---|-----|
| <b>1</b> Power windows .....   | 30  | Control indicator for airbag<br>deactivation .....       | 75  | <b>19</b> Selector lever, manual<br>transmission .....      | 130 |
| <b>2</b> Exterior mirrors .....  | 27  | Control indicator for front<br>passenger seat belt ..... | 75  | Automatic transmission .....                                | 127 |
| <b>3</b> Cruise control .....  | 138 | <b>11</b> Info-Display .....                             | 84  | <b>20</b> Ignition switch with<br>steering wheel lock ..... | 121 |
| Speed limiter .....  | 139 | <b>12</b> Anti-theft alarm system<br>status LED .....    | 25  | <b>21</b> Horn .....  | 64  |
| <b>4</b> Side air vents .....  | 118 | <b>13</b> Centre air vents .....                         | 118 | Driver airbag .....   | 42  |
| <b>5</b> Turn and lane-change<br>signals, headlight flash,<br>low beam and high beam ...                                       | 106 | <b>14</b> Glovebox .....                                 | 52  | <b>22</b> Bonnet release lever .....                        | 156 |
| Exit lighting .....  | 110 | Fuse box .....   | 174 | <b>23</b> Storage compartment .....                         | 53  |
| Parking lights .....   | 107 | <b>15</b> Sport mode .....                               | 135 | <b>24</b> Steering wheel adjustment . .                     | 63  |
| Driver Information Centre .....  | 81  | Tour mode .....  | 135 | <b>25</b> Light switch .....                                | 99  |
| <b>6</b> Instruments .....   | 70  | Traction Control system .....                            | 134 | Headlight range<br>adjustment .....                         | 101 |
| <b>7</b> Steering wheel controls .....   | 63  | Electronic Stability Control .                           | 134 | Front fog lights .....                                      | 106 |
| <b>8</b> Driver Information Centre .....   | 81  | Parking assist .....                                     | 141 | Rear fog light .....  | 107 |
| <b>9</b> Windscreen wiper,<br>windscreen washer<br>system, headlight washer<br>system, rear wiper, rear<br>washer system ..... | 65  | Lane departure warning .....                             | 146 | Instrument illumination .....                               | 108 |
| <b>10</b> Central locking system .....   | 21  | Eco button .....   | 123 |   |     |
| Hazard warning flashers .....  | 106 | <b>16</b> Climate control system .....                   | 112 |   |     |
|  |     | <b>17</b> AUX input, USB input .....                     | 10  |   |     |
|  |     | <b>18</b> Power outlet .....                             | 69  |   |     |

## Exterior lighting



Turn light switch:

- = lights off
- ☞ = sidelights
- ☞☞ = headlights



### Automatic light control

- AUTO** = automatic light control: Headlights are switched on and off automatically
- ☞ = activation or deactivation of the automatic light control
- ☞☞ = sidelights
- ☞☞☞ = headlights

### Fog lights

Press light switch:

- ☞☞☞ = front fog lights
- ☞☞☞☞ = rear fog light

Lighting ⇨ 99.

## Headlight flash, high beam and low beam

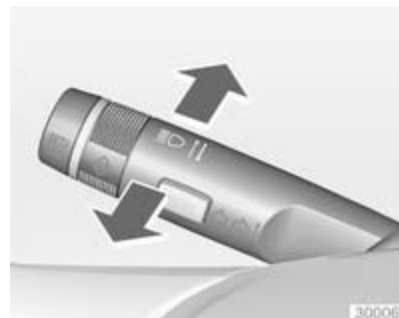

- headlight flash = pull lever
- high beam = push lever
- low beam = push or pull lever

Automatic light control ⇨ 100, High beam ⇨ 100, High beam assist ⇨ 100, Headlight flash ⇨ 101, Adaptive forward lighting ⇨ 102.

## Turn and lane-change signals



lever up = right turn signal  
lever down = left turn signal

Turn and lane-change signals  
↪ 106, Parking lights ↪ 107.

## Hazard warning flashers



Operated with the  button.  
Hazard warning flashers ↪ 106.

## Horn



Press .

## Washer and wiper systems

### Windscreen wiper



- 2** = fast
- 1** = slow
-  = timed interval wiping or automatic wiping with rain sensor
- O** = off

For a single wipe when the windscreen wiper is off, press the lever down.

Windscreen wiper ↻ 65, Wiper blade replacement ↻ 162.

### Windscreen and headlight washer systems

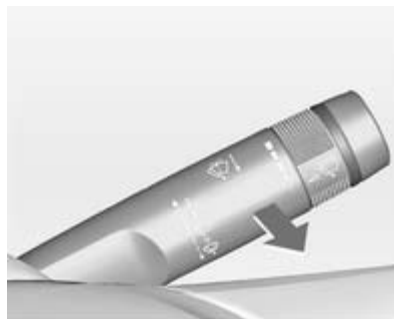

Pull lever.

Windscreen and headlight washer system ↻ 65, Washer fluid ↻ 159.

### Rear window wiper and washer systems



Press the rocker switch to activate the rear window wiper:

- upper position = continuous operation
- lower position = intermittent operation
- middle position = off

Rear window wiper/washer ↻ 67.

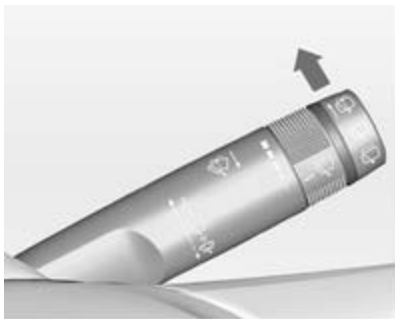

Push lever.

Washer fluid is sprayed on the rear window and the wiper wipes a few times.

## Climate control

### Heated rear window, heated exterior mirrors



The heating is operated by pressing the  button.

Heated rear window  31.

### Demisting and defrosting the windows



Press button .

Set the temperature control to the highest level.

Cooling  on.

Heated rear window  on.

Climate control system  112.



## Transmission

### Manual transmission



Reverse: with the vehicle stationary, wait 3 seconds after depressing clutch pedal and then press the release button on the selector lever and engage the gear.

If the gear does not engage, set the lever to neutral, release the clutch pedal and depress again; then repeat gear selection.

Manual transmission ⇨ 130.

### Automatic transmission



**P** = park  
**R** = reverse  
**N** = neutral  
**D** = drive

Manual mode: move selector lever from **D** to the left.

**+** = higher gear  
**-** = lower gear

The selector lever can only be moved out of **P** when the ignition is on and the brake pedal is applied. To engage **P** or **R**, press the release button.

Automatic transmission ⇨ 127.

## Starting off

### Check before starting off

- Tyre pressure and condition ⇨ 178, ⇨ 213.
- Engine oil level and fluid levels ⇨ 157.
- All windows, mirrors, exterior lighting and number plates are free from dirt, snow and ice and are operational.
- Proper position of mirrors, seats, and seat belts ⇨ 27, ⇨ 35, ⇨ 41.
- Brake function at low speed, particularly if the brakes are wet.

## Starting the engine

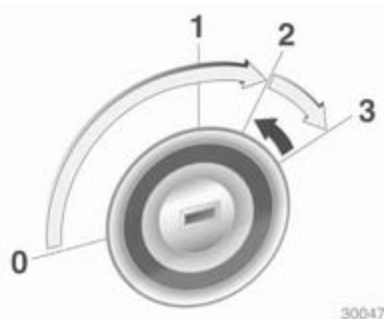

- Turn key to position **1**
- move the steering wheel slightly to release the steering wheel lock
- operate clutch and brake
- automatic transmission in **P** or **N**
- do not operate accelerator pedal
- diesel engines: turn the key to position **2** for preheating and wait until control indicator  extinguishes
- turn key to position **3** and release

Starting the engine ⇨ 121.

## Stop-start system



If the vehicle is at a low speed or at a standstill and certain conditions are fulfilled, activate an Autostop as follows:

- Depress the clutch pedal
- set the lever in neutral
- release the clutch pedal

An Autostop is indicated by the needle at the **AUTOSTOP** position in the tachometer.

To restart the engine, depress the clutch pedal again.

Stop-start system ⇨ 123.

## Parking

- Always apply the parking brake. Activate the manual parking brake without pressing the release button. Apply as firmly as possible on a downhill slope or uphill slope. Depress foot brake at the same time to reduce operating force. For vehicles with electrical parking brake, pull switch .

- Switch off the engine. Turn the ignition key to position **0** and remove it. Turn the steering wheel until the steering wheel lock is felt to engage.

For vehicles with automatic transmission, the key can only be removed when the selector lever is in the **P** position.

- If the vehicle is on a level surface or uphill slope, engage first gear or set the selector lever to **P** before switching off the ignition. On an uphill slope, turn the front wheels away from the kerb.

If the vehicle is on a downhill slope, engage reverse gear or set the

selector lever to **P** before switching off the ignition. Turn the front wheels towards the kerb.

- Lock the vehicle with button  on the radio remote control.

Activate the anti-theft alarm system  
⇨ 25.

- Do not park the vehicle on an easily ignitable surface. The high temperature of the exhaust system could ignite the surface.
- Close the windows.
- The engine cooling fans may run after the engine has been switched off ⇨ 156.
- After running at high engine speeds or with high engine loads, operate the engine briefly at a low load or run in neutral for approx. 30 seconds before switching off, in order to protect the turbocharger.

Keys, locks ⇨ 19, Laying the vehicle up for a long period of time ⇨ 155.

## Keys, doors and windows

Keys, locks .....	19
Doors .....	23
Vehicle security .....	25
Exterior mirrors .....	27
Interior mirrors .....	29
Windows .....	29

## Keys, locks

### Keys

#### Replacement keys

The key number is specified in the Car Pass or on a detachable tag.

The key number must be quoted when ordering replacement keys as it is a component of the immobiliser system.

Locks ⇨ 193.

#### Lock cylinders

Designed to free-wheel if they are forcefully rotated without the correct key or if the correct key is not fully inserted. To reset, turn cylinder with the correct key until its slot is vertical, remove key and then re-insert it. If the cylinder still free-wheels, turn the key through 180° and repeat operation.

### Key with foldaway key section



Press button to extend. To fold the key, first press the button.

### Car Pass

The Car Pass contains security related vehicle data and should therefore be kept in a safe place.

When the vehicle is taken to a workshop, this vehicle data is needed in order to perform certain operations.

## Radio remote control



Used to operate:

- Central locking system
- Anti-theft locking system
- Anti-theft alarm system
- Power windows

The radio remote control has an approximate range of up to 20 metres. It can be restricted by external influences. The hazard warning flashers confirm operation.

Handle with care, protect from moisture and high temperatures and avoid unnecessary operation.

## Fault

If the central locking system cannot be operated with the radio remote control, it may be due to the following:

- Range exceeded
- Battery voltage too low
- Frequent, repeated operation of the radio remote control while not in range, which will require re-synchronisation
- Overload of the central locking system by operating at frequent intervals, the power supply is interrupted for a short time
- Interference from higher-power radio waves from other sources

Unlocking ⇨ 21.

## Basic settings

Some settings can be changed in the menu **Settings** in the Info-Display. Vehicle personalisation ⇨ 93.

## Radio remote control battery replacement

Replace the battery as soon as the range reduces.



Batteries do not belong in household waste. They must be disposed of at an appropriate recycling collection point.

## Key with foldaway key section



Extend the key and open the unit. Replace the battery (battery type CR 2032), paying attention to the installation position. Close the unit and synchronise.

### Radio remote control synchronisation

After replacing the battery, unlock the door with the key in the driver's door lock. The radio remote control will be synchronised when you switch on the ignition.

### Memorised settings

Whenever the key is removed from the ignition switch, the following settings are automatically memorised by the key:

- Lighting
- Infotainment system
- Central locking system
- Sport mode settings
- Comfort settings

The saved settings are automatically used the next time the memorised key is inserted into the ignition switch and turned to position 1 ↷ 121.

A precondition is that **Personalization by driver** is activated in the personal settings of the Graphic-Info-Display. This must be set for each key used. On vehicles equipped with Colour-Info-Display, the personalisation is permanently activated.

Vehicle personalisation ↷ 93.

### Central locking system

Unlocks and locks doors, load compartment and fuel filler flap.

A pull on an interior door handle unlocks the respective door. Pulling the handle once more opens the door.

#### Note

In the event of an accident in which airbags or belt pretensioners are deployed, the vehicle is automatically unlocked.

#### Note



A short time after unlocking with the remote control the doors are locked automatically if no door has been opened.

### Unlocking



Press button .

Two settings are selectable:

- To unlock only the driver's door, load compartment and fuel filler flap, press button  once. To unlock both doors, press button  twice or

- press button  once to unlock both doors, load compartment and fuel filler flap

The setting can be changed in the menu **Settings** in the Info-Display. Vehicle personalisation ⇨ 93.

The setting can be saved for the key being used. Memorised settings ⇨ 21.

Unlocking and opening the tailgate ⇨ 23.

## Locking

Close doors, load compartment and fuel filler flap.



Press button .

If the driver's door is not closed properly, the central locking system will not work.

## Central locking buttons

Locks or unlocks both doors, the load compartment and fuel filler flap from the passenger compartment.



Press the  button to lock.

Press the  button to unlock.

## Fault in radio remote control system

### Unlocking



Manually unlock the driver's door by turning the key in the lock. Switch on the ignition and press the central locking button  to unlock passenger's door, load compartment and fuel filler flap. By switching on the ignition, the anti-theft locking system is deactivated.

### Locking

Manually lock the driver's door by turning the key in the lock.

## Fault in central locking system

### Unlocking

Manually unlock the driver's door by turning the key in the lock. The passenger's door can be opened by pulling the interior handle twice. The load compartment and fuel filler flap cannot be opened. To deactivate the anti-theft locking system, switch on the ignition ⇨ 25.

### Locking

Push inside locking knob of passenger's door. Then close the driver's door and lock it from the outside with the key. The fuel filler flap and tailgate cannot be locked.

## Automatic locking

This security feature can be configured to automatically lock the doors, load compartment and fuel filler flap as soon as a certain speed is exceeded.

Additionally it is configurable to unlock the driver's door or all doors after the ignition is switched off and

the ignition key is removed (manual transmission) or the selector lever is moved to **P** position (automatic transmission).

Settings can be changed in the menu **Settings** in the Info-Display. Vehicle personalisation ⇨ 93.

The settings can be saved for the key being used ⇨ 21.

## Doors

### Load compartment

### Tailgate

#### Opening



Press button  on radio remote control or push the brand emblem at the bottom half to unlock and open the tailgate.





Pressing button  opens the tailgate even if the doors are locked.  
Central locking system ⇨ 21.

### Closing

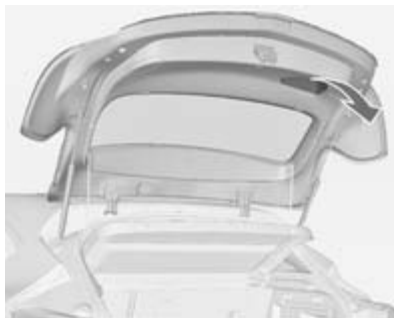

Use the interior handle.  
Do not touch the brand emblem whilst closing as this could unlock the tailgate again.  
Central locking system ⇨ 21.

### General hints for operating tailgate

#### Warning

Do not drive with the tailgate open or ajar, e.g. when transporting bulky objects, since toxic exhaust gases, which can not be seen or smelled, could enter the vehicle. This can cause unconsciousness and even death.

#### Caution

Before opening the tailgate check overhead obstructions, such as a garage door, to avoid damage to the tailgate. Always check the moving area above and behind the tailgate.

#### Note

The installation of certain heavy accessories onto the tailgate may affect its ability to remain open.

## Vehicle security

### Anti-theft locking system

#### Warning

Do not use the system if there are people in the vehicle! The doors cannot be unlocked from the inside.

The system deadlocks the doors. The doors must be closed otherwise the system cannot be activated.

If the ignition was on, the driver's door must be opened and closed once so that the vehicle can be secured.

Unlocking the vehicle disables the mechanical anti-theft locking system. This is not possible with the central locking button.

### Activating



Press  on the radio remote control twice within 15 seconds.

### Anti-theft alarm system

The anti-theft alarm system is combined with the central locking system.

It monitors:

- Doors, tailgate, bonnet
- Passenger compartment including adjoining load compartment
- Vehicle inclination, e.g. if it is raised
- Ignition

### Activation

- Self-activated 30 seconds after locking the vehicle (initialisation of the system)
- Directly by pressing  on the radio remote control once more after locking



#### Note

Changes to the vehicle interior, such as the use of seat covers and open windows, could impair the function of passenger compartment monitoring.

### Activation without monitoring of passenger compartment and vehicle inclination



Switch off the monitoring of passenger compartment and vehicle inclination when animals are being left in the vehicle, because of high volume ultrasonic signals or movements triggering the alarm. Also switch off when the vehicle is on a ferry or train.

1. Close tailgate, bonnet, windows.
2. Press button . LED in the button  illuminates for a maximum of 10 minutes.

3. Close doors.
4. Activate the anti-theft alarm system.

Status message is displayed in the Driver Information Centre.

### Status LED



Status LED is integrated in the sensor on top of the instrument panel.

Status during the first 30 seconds of anti-theft alarm system activation:

LED illuminates = test, arming delay.  
 LED flashes quickly = doors, tailgate or bonnet not completely closed, or system fault.

Status after system is armed:

LED flashes slowly = system is armed.

Seek the assistance of a workshop in the event of faults.

### Deactivation

Unlocking the vehicle deactivates the anti-theft alarm system.

### Alarm

When triggered, the alarm sounds via a separate battery-backed power sounder, and the hazard warning lights flash simultaneously. The number and duration of alarm signals are stipulated by legislation.

The alarm can be silenced by pressing any button on the radio remote control or by switching on the ignition.

The anti-theft alarm system can be deactivated only by pressing button  or by switching on the ignition.

A triggered alarm, which has not been interrupted by the driver, will be indicated by the hazard warning lights. They will flash quickly three times when the vehicle is unlocked next time with the radio remote control. Additionally a warning message or a warning code is displayed in the Driver Information Centre after switching on the ignition. Vehicle messages ⇨ 86.

If the vehicle's battery is to be disconnected (e.g. for maintenance work), the alarm siren must be deactivated as follows: switch the ignition on then off, then disconnect the vehicle's battery within 15 seconds.

## Immobiliser

The system is part of the ignition switch and checks whether the vehicle is allowed to be started with the key being used.

The immobiliser is activated automatically after the key has been removed from the ignition switch.

If the control indicator  flashes when the ignition is on, there is a fault in the system; the engine cannot be started. Switch off the ignition and repeat the start attempt.

If the control indicator continues flashing, attempt to start the engine using the spare key and seek the assistance of a workshop.

### Note

The immobiliser does not lock the doors. You should always lock the vehicle after leaving it and switch on the anti-theft alarm system ⇨ 21, ⇨ 25.

Control indicator  ⇨ 80.

## Exterior mirrors

### Convex shape

The convex exterior mirror contains an aspherical area and reduces blind spots. The shape of the mirror makes objects appear smaller, which will affect the ability to estimate distances.

### Electric adjustment

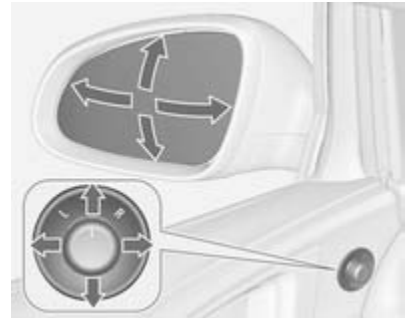

Select the relevant exterior mirror by turning the control to left (L) or right (R). Then swivel the control to adjust the mirror.

In position **0** no mirror is selected.

## Folding



For pedestrian safety, the exterior mirrors will swing out of their normal mounting position if they are struck with sufficient force. Reposition the mirror by applying slight pressure to the mirror housing.

## Electric folding



Turn control to **0**, then push the control down. Both exterior mirrors will fold.

Push the control down again - both exterior mirrors return to their original position.

If an electrically folded mirror is manually extended, pressing down the control will only electrically extend the other mirror.

## Heated



Operated by pressing the  button.

Heating works with the engine running and is switched off automatically after a short time.

## Interior mirrors

### Manual anti-dazzle

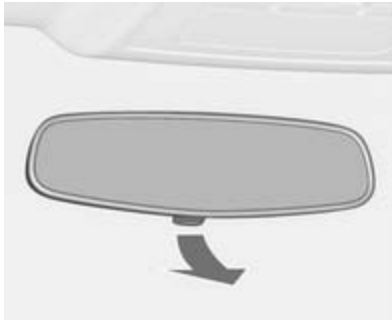

To reduce dazzle, adjust the lever on the underside of the mirror housing.

### Automatic anti-dazzle



Dazzle from following vehicles at night is automatically reduced.

## Windows

### Windscreen

#### Heat-reflecting windscreen

The heat-reflecting windscreen has a coating which reflects solar radiation. Also data signals, e.g. from toll stations, might be reflected.

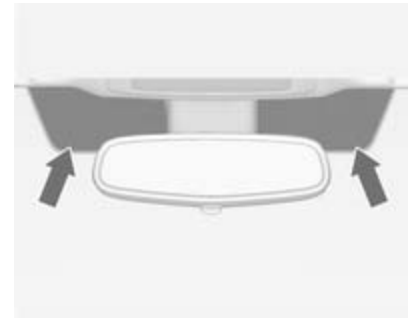

The marked areas of the windscreen behind the interior mirror are not covered with the coating. Devices for electronic data recording and fee

payment must be attached in these areas. Otherwise data recording malfunctions may occur.

## Power windows

### ⚠ Warning

Take care when operating the power windows. Risk of injury, particularly to children.

Keep a close watch on the windows when closing them. Ensure that nothing becomes trapped in them as they move.

Switch on ignition to operate power windows. Retained power off ⇨ 121.



Operate the switch for the respective window by pushing to open or pulling to close.

Pushing or pulling gently to the first detent: window moves up or down as long as the switch is operated.

Pushing or pulling firmly to the second detent and then releasing: window moves up or down automatically with safety function enabled. To stop movement, operate the switch once more in the same direction.

## Safety function

If the window glass encounters resistance above the middle of the window during automatic closing, it is immediately stopped and opened again.

## Override safety function

In the event of closing difficulties due to frost or the like, switch on the ignition, then pull the switch to the first detent and hold. The window moves up without safety function enabled. To stop movement, release the switch.

## Operating windows from outside

The windows can be operated remotely from outside the vehicle.

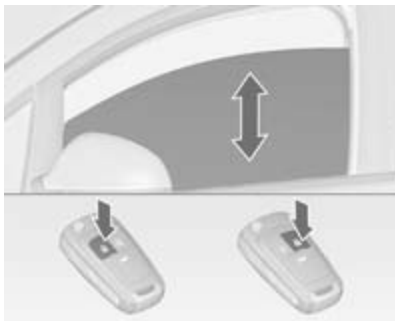

Press and hold  button to open windows.

Press and hold  button to close windows.

Release button to stop window movement.

If the windows are fully opened or closed, the hazard warning lights will flash twice.

### Overload

If the windows are repeatedly operated within short intervals, the window operation is disabled for some time.

### Initialising the power windows

If the windows cannot be closed automatically (e.g. after disconnecting the vehicle battery), a warning message or a warning code is displayed in the Driver Information Centre.

Vehicle messages ⇨ 86.

Activate the window electronics as follows:

1. Close doors.
2. Switch on ignition.
3. Pull switch until the window is closed and keep pulling for additional 2 seconds.
4. Repeat for each window.

### Heated rear window



Operated by pressing the  button.

Heating works with the engine running and is switched off automatically after a short time.

Depending on the engine type, the heated rear window comes on automatically when the diesel particle filter is being cleaned.

### Sun visors

The sun visors can be folded down or swivelled to the side to prevent dazzling.



If the sun visors have integral mirrors, the mirror covers should be closed when driving.

A ticket holder is located on the backside of the sun visor.

## Glass panel

### Panorama roof

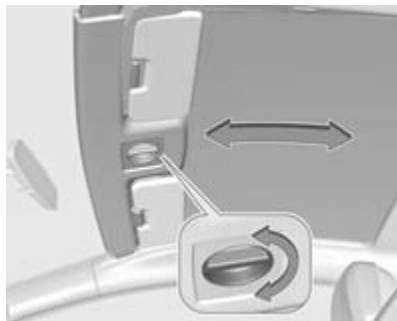

Turn the handle and move the roof cover to a suitable position.

The roof cover engages in position after releasing the handle.

### Note

Close the sun visors before sliding the roof lining.

## Seats, restraints

Head restraints .....	33
Front seats .....	35
Rear seats .....	39
Seat belts .....	40
Airbag system .....	42
Child restraints .....	46

## Head restraints

### Position

#### **⚠ Warning**

Only drive with the head restraint set to the proper position.

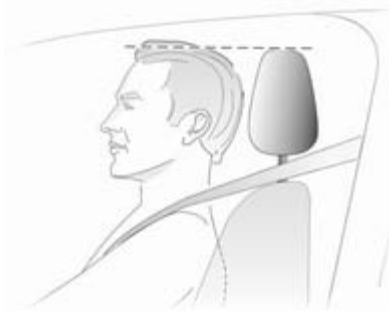

The upper edge of the head restraint should be at upper head level. If this is not possible for extremely tall people, set to highest position, and set to lowest position for small people.

## Adjustment

### Head restraints on front seats

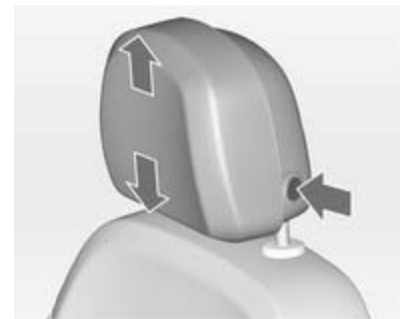

### Height adjustment

Press the button, adjust height and engage.

### Horizontal adjustment

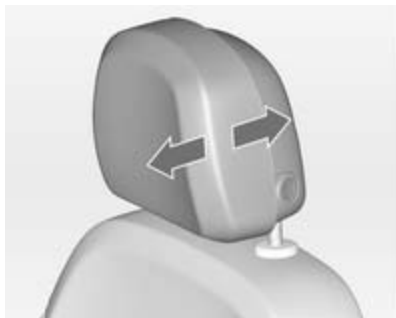

To adjust horizontally, pull the head restraint forwards. It engages in several positions.

To return to its rearmost position, pull fully forwards and release.

### Head restraints on rear seats



#### Height adjustment

Pull the head restraint upwards or press the catch to release and push the head restraint downwards.

#### Removal

Press both catches, pull the head restraint upwards and remove.

### Active head restraints

In the event of a rear-end impact, the front parts of the active head restraints are moved slightly

forwards. Thus the head is supported so that the risk of whiplash injury is reduced.

#### Note

Approved accessories may only be attached if the seat is not in use.

## Front seats

### Seat position

#### **⚠ Warning**

Only drive with the seat correctly adjusted.



- Sit with buttocks as far back against the backrest as possible. Adjust the distance between the seat and the pedals so that legs are slightly angled when pressing the pedals. Slide the front passenger seat as far back as possible.

- Sit with shoulders as far back against the backrest as possible. Set the backrest rake so that it is possible to easily reach the steering wheel with arms slightly bent. Maintain contact between shoulders and the backrest when turning the steering wheel. Do not angle the backrest too far back. We recommend a maximum rake of approx. 25°.
- Adjust the steering wheel ↻ 63.
- Set seat height high enough to have a clear field of vision on all sides and of all display instruments. There should be at least one hand of clearance between head and the roof frame. Your thighs should rest lightly on the seat without pressing into it.
- Adjust the head restraint ↻ 33.
- Adjust the thigh support so that there is a space approx. two fingers wide between the edge of the seat and the hollow of the knee.
- Adjust the lumbar support so that it supports the natural shape of the spine.

## Seat adjustment

#### **⚠ Danger**

Do not sit nearer than 25 cm from the steering wheel, to permit safe airbag deployment.

#### **⚠ Warning**

Never adjust seats while driving as they could move uncontrollably.

#### **⚠ Warning**

Never store any subjects under the seats.

Drive only with engaged seats and backrests.

### Seat positioning

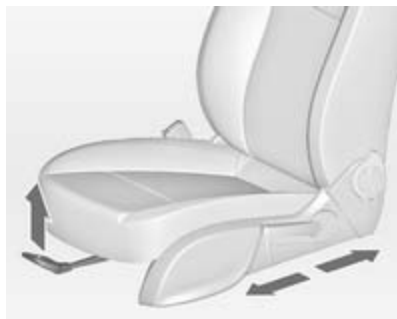

Pull handle, slide seat, release handle.

### Seat backrest



Pull lever, adjust inclination and release lever. Allow the backrest to engage audibly.

### Seat height

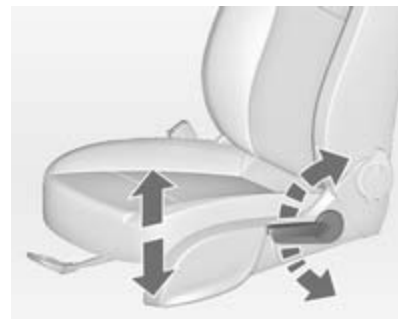

Lever pumping motion  
up = seat higher  
down = seat lower

### Seat inclination

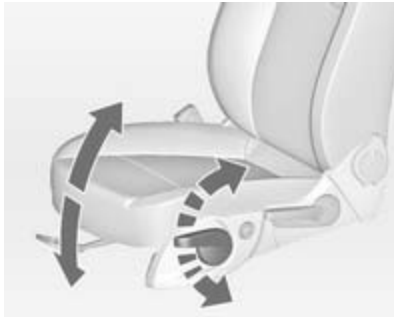

Lever pumping motion

up = front end higher

down = front end lower

### Lumbar support



Adjust lumbar support using the four-way switch to suit personal requirements.

Moving support up and down: push switch up or down.

Increasing and decreasing support: push switch forwards or backwards.

### Adjustable thigh support

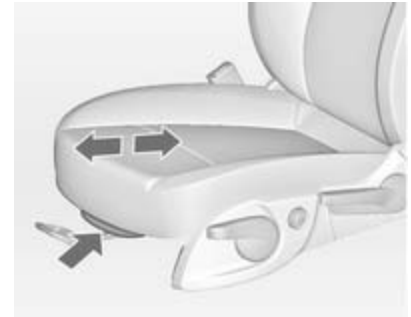

Pull the lever and slide the thigh support.

### Side bolster, VXR version



Adjust seat width and backrest width using the switches to suit personal requirements.

Operate front rocker switch to change seat width.

Operate rear rocker switch to change backrest width.

### Seat folding



Lift release lever and fold backrest forwards. Slide seat forwards.

To restore, slide the seat backwards. Move the backrest against the resistance to the upright position and engage.

The memory function allows the seat to engage in its original position.

Do not operate backrest inclination lever while backrest is tilted forward.

Vehicles with panorama roof: to tilt backrest forward, push head restraints down and lift up sun visors.



The illustration shows the release lever on VXR seat.

#### **⚠ Danger**

Move the backrest to an upright position before folding to avoid injury.

## Armrest

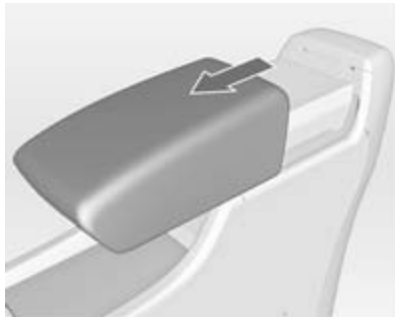

The armrest can be slid forwards by 10 cm. Under the armrest there is a storage compartment.

Armrest storage ⇨ 54.

## Heating



Adjust heating to the desired setting by pressing the ☀ button for the respective seat one or more times. The control indicator in the button indicates the setting.

Prolonged use of the highest setting for people with sensitive skin is not recommended.

Seat heating is operational when engine is running and during an Autostop.

Stop-start system ⇨ 123.

## Rear seats

### Armrest

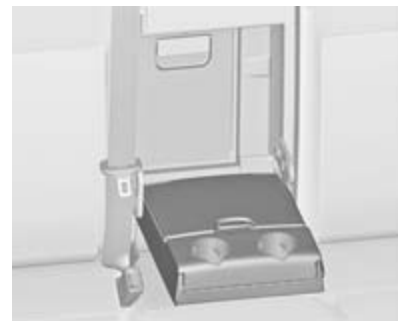

Fold armrest down. The armrest contains cupholders and a storage box.



## Seat belts



The seat belts are locked during heavy acceleration or deceleration of the vehicle holding the occupants in the sitting position. Therefore the risk of injury is considerably reduced.

### ⚠ Warning

Fasten seat belt before each trip. In the event of an accident, people not wearing seat belts endanger their fellow occupants and themselves.

Seat belts are designed to be used by only one person at a time. They are not suitable for people smaller than 150 cm. Child restraint system ⇨ 46.

Periodically check all parts of the belt system for damage, pollution and proper functionality.

Have damaged components replaced. After an accident, have the belts and triggered belt pretensioners replaced by a workshop.

### ⚠ Warning

The openings in the backrests of the VXR seats are not designed to mount or carry through any kind of additional seat belts.

### Note

Make sure that the belts are not damaged by shoes or sharp-edged objects or trapped. Prevent dirt from getting into the belt retractors.

## Seat belt reminder

Front seats are equipped with a seat belt reminder, indicated for driver seat as control indicator  in the tachometer ⇨ 75 and for passenger seat in the centre console ⇨ 72.

## Belt force limiters

On the front seats, stress on the body is reduced by the gradual release of the belt during a collision.

## Belt pretensioners

In the event of a head-on or rear-end collision of a certain severity, the front seat belts are tightened.

### ⚠ Warning

Incorrect handling (e.g. removal or fitting of belts) can trigger the belt pretensioners.

Deployment of the belt pretensioners is indicated by continuous illumination of control indicator  ⇨ 75.

Triggered belt pretensioners must be replaced by a workshop. Belt pretensioners can only be triggered once.

### Note

Do not affix or install accessories or other objects that may interfere with the operation of the belt pretensioners. Do not make any modifications to belt pretensioner components as this will invalidate the vehicle type approval.

## Three-point seat belt

### Fastening



Withdraw the belt from the retractor, guide it untwisted across the body and insert the latch plate into the buckle. Tighten the lap belt regularly whilst driving by pulling the shoulder belt.



Loose or bulky clothing prevents the belt from fitting snugly. Do not place objects such as handbags or mobile phones between the belt and your body.

<b>Warning</b>
The belt must not rest against hard or fragile objects in the pockets of your clothing.

Seat belt reminder   75.

### Removing



To release belt, press red button on belt buckle.

### Seat belts on the rear seats

The seat belt for the rear centre seat can only be withdrawn from the retractor if the backrest is engaged in upright position.

### Using the seat belt while pregnant



#### ⚠ Warning

The lap belt must be positioned as low as possible across the pelvis to prevent pressure on the abdomen.

## Airbag system

The airbag system consists of a number of individual systems depending on the scope of equipment.

When triggered the airbags inflate within milliseconds. They also deflate so quickly that it is often unnoticeable during the collision.

#### ⚠ Warning

If handled improperly the airbag systems can be triggered in an explosive manner.

#### Note



The airbag systems and belt pretensioner control electronics are located in the centre console area. Do not put any magnetic objects in this area.

Do not stick anything on the airbag covers and do not cover them with other materials.

Each airbag is triggered only once. Have deployed airbags replaced by a workshop. Furthermore, it might be necessary to have the steering wheel, the instrument panel, parts of the panelling, the door seals, handles and the seats replaced.

Do not make any modifications to the airbag system as this will invalidate the vehicle type approval.

When the airbags inflate escaping hot gases may cause burns.

Control indicator  for airbag systems  75.

## Front airbag system

The front airbag system consists of one airbag in the steering wheel and one in the instrument panel on the front passenger side. These can be identified by the word **AIRBAG**.



There are also warning labels on both sides of the sunblind on the front passenger side.

The front airbag system is triggered in the event of a front-end impact of a certain severity. The ignition must be switched on.

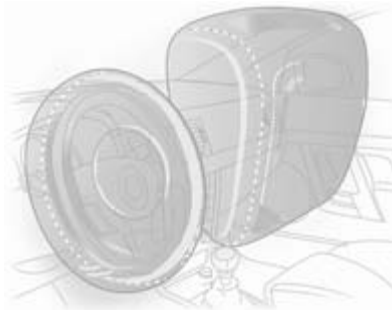

The inflated airbags cushion the impact, thereby reducing the risk of injury to the upper body and head of the front seat occupants considerably.

#### **Warning**

Optimum protection is only provided when the seat is in the proper position ↗ 35.

Keep the area in which the airbag inflates clear of obstructions.

Fit the seat belt correctly and engage securely. Only then the airbag is able to protect.

### Side airbag system



The side airbag system consists of an airbag in each front seat backrest. This can be identified by the word **AIRBAG**.

The side airbag system is triggered in the event of a side impact of a certain severity. The ignition must be switched on.

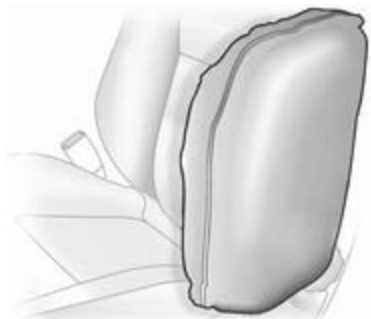

The inflated airbags cushion the impact, thereby reducing the risk of injury to the upper body and pelvis in the event of a side-on collision considerably.

#### **⚠ Warning**

Keep the area in which the airbag inflates clear of obstructions.

#### **Note**

Only use protective seat covers that have been approved for the vehicle. Be careful not to cover the airbags.

### **Curtain airbag system**

The curtain airbag system consists of an airbag in the roof frame on each side. This can be identified by the word **AIRBAG** on the roof pillars.

The curtain airbag system is triggered in the event of a side-on impact of a certain severity. The ignition must be switched on.

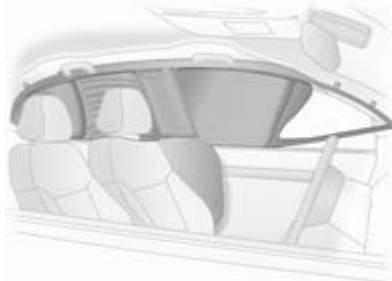

The inflated airbags cushion the impact, thereby reducing the risk of injury to the head in the event of a side-on impact considerably.

#### **⚠ Warning**

Keep the area in which the airbag inflates clear of obstructions.

The hooks on the handles in the roof frame are only suitable for hanging up light articles of clothing, without coat hangers. Do not keep any items in these clothes.



### **Airbag deactivation**

The front passenger airbag system must be deactivated if a child restraint system is to be fitted on this seat. The side airbag and curtain airbag systems, the belt pretensioners and all driver airbag systems will remain active.



The front passenger airbag system can be deactivated via a key-operated switch on the right side of the instrument panel.

Use the ignition key to choose the position:

 OFF = front passenger airbag is deactivated and will not inflate in the event of a collision. Control indicator  OFF illuminates continuously in the centre console. A child restraint system can be installed in accordance with the chart **Child restraint installation locations** ⇨ 48. No adult person is allowed to occupy the front passenger seat.

 ON = front passenger airbag is active. A child restraint system must not be installed.

### Danger

Risk of fatal injury for a child using a child restraint system on a seat with activated front passenger airbag.

Risk of fatal injury for an adult person on a seat with deactivated front passenger airbag.



If the control indicator  illuminates for approx. 60 seconds after the ignition is switched on, the front passenger airbag system will inflate in the event of a collision.

If both control indicators are illuminated at the same time, there is a system failure. The status of the system is not discernible, therefore no person is allowed to occupy the front passenger seat. Contact a workshop immediately.

Change status only when the vehicle is stopped with the ignition off.

Status remains until the next change.

Control indicator for airbag deactivation ⇨ 75.

## Child restraints

### Child restraint systems

We recommend the Vauxhall child restraint system which is tailored specifically to the vehicle.

When a child restraint system is being used, pay attention to the following usage and installation instructions and also those supplied with the child restraint system.

Always comply with local or national regulations. In some countries, the use of child restraint systems is forbidden on certain seats.

#### Warning

When using a child restraint system on the front passenger seat, the airbag systems for the front passenger seat must be deactivated; if not, the triggering of the airbags poses a risk of fatal injury to the child.

This is especially the case if rear-facing child restraint systems are used on the front passenger seat.

### Selecting the right system

The rear seats are the most convenient location to fasten a child restraint system.

Children should travel facing rearwards in the vehicle as long as possible. This makes sure that the child's backbone, which is still very weak, is under less strain in the event of an accident.

Children under the age of 12 years that are smaller than 150 cm are only allowed to travel in a restraint system that is suitable for the child. Suitable are restraint systems that comply with ECE 44-03 or ECE 44-04. Since a proper position of the belt is rarely possible with a child that is smaller than 150 cm, we strongly advise the use of an appropriate child restraint system, even though this might, due to the age of the child, no longer be legally binding.

Ensure that the child restraint system to be installed is compatible with the vehicle type.

Ensure that the mounting location of the child restraint system within the vehicle is correct.

Allow children to enter and exit the vehicle only on the side facing away from the traffic.

When the child restraint system is not in use, secure the seat with a seat belt or remove it from the vehicle.

**Note**

Do not stick anything on the child restraint systems and do not cover them with any other materials.

A child restraint system which has been subjected to stress in an accident must be replaced.



## Child restraint installation locations

### Permissible options for fitting a child restraint system

Weight and age class	On front passenger seat		On rear outboard seats	On rear centre seat
	activated airbag	deactivated airbag		
<b>Group 0: up to 10 kg</b> or approx. 10 months	X	U <sup>1</sup>	U <sup>2</sup>	U
<b>Group 0+: up to 13 kg</b> or approx. 2 years	X	U <sup>1</sup>	U <sup>2</sup>	U
<b>Group I: 9 to 18 kg</b> or approx. 8 months to 4 years	X	U <sup>1</sup>	U <sup>2</sup>	U
<b>Group II: 15 to 25 kg</b> or approx. 3 to 7 years	X	X	U	U
<b>Group III: 22 to 36 kg</b> or approx. 6 to 12 years	X	X	U	U

<sup>1</sup> = Only if front passenger seat airbag system is deactivated. If the child restraint system is being secured using a three-point seat belt, move seat height adjustment to uppermost position and ensure that vehicle safety belt runs forwards from the upper anchorage point. Adjust seat backrest inclination as far as necessary to a vertical position to ensure that the belt is tight on the buckle side.

<sup>2</sup> = Seat available with ISOFIX and Top-Tether mounting brackets ⇨ 51.

U = Universal suitability in conjunction with three-point seat belt.

X = No child restraint system permitted in this weight class.

### Permissible options for fitting an ISOFIX child restraint system

Weight class	Size class	Fixture	On front passenger seat	On rear outboard seats	On rear centre seat
Group 0: up to 10 kg	E	ISO/R1	X	IL	X
	D	ISO/R2	X	IL	X
Group 0+: up to 13 kg	E	ISO/R1	X	IL	X
	D	ISO/R2	X	IL	X
	C	ISO/R3	X	IL	X
Group I: 9 to 18 kg	D	ISO/R2	X	IL	X
	C	ISO/R3	X	IL	X
	B	ISO/F2	X	IL, IUF	X
	B1	ISO/F2X	X	IL, IUF	X
	A	ISO/F3	X	IL, IUF	X

IL = Suitable for particular ISOFIX restraint systems of the 'specific-vehicle', 'restricted' or 'semi-universal' categories.  
The ISOFIX restraint system must be approved for the specific vehicle type.

IUF = Suitable for ISOFIX forward-facing child restraint systems of universal category approved for use in this weight class.

X = No ISOFIX child restraint system approved in this weight class.

**ISOFIX size class and seat device**

- A – ISO/F3 = Forward-facing child restraint system for children of maximum size in the weight class 9 to 18 kg.
- B – ISO/F2 = Forward-facing child restraint system for smaller children in the weight class 9 to 18 kg.
- B1 – ISO/F2X = Forward-facing child restraint system for smaller children in the weight class 9 to 18 kg.
- C – ISO/R3 = Rear-facing child restraint system for children of maximum size in the weight class up to 13 kg.
- D – ISO/R2 = Rear-facing child restraint system for smaller children in the weight class up to 13 kg.
- E – ISO/R1 = Rear-facing child restraint system for young children in the weight class up to 13 kg.

## ISOFIX child restraint systems



Fasten vehicle-approved ISOFIX child restraint systems to the ISOFIX mounting brackets. Specific vehicle ISOFIX child restraint system positions are marked in the table by IL.

ISOFIX mounting brackets are indicated by a label on the backrest.

## Top-tether fastening eyes

Top-Tether fastening eyes are marked with the symbol  for a child seat.



In addition to the ISOFIX mounting fasten the Top-Tether strap to the Top-Tether fastening eyes. The strap must run between the two guide rods of the head restraint.

ISOFIX child restraint systems of universal category positions are marked in the table by IUF.

## Storage

Storage compartments .....	52
Load compartment .....	55
Roof rack system .....	61
Loading information .....	61

## Storage compartments

### Glovebox



The glovebox features a pen holder, a credit card holder and a coin holder.

The intermediate shelf can be removed.

The glovebox should be closed whilst driving.

## Cupholders

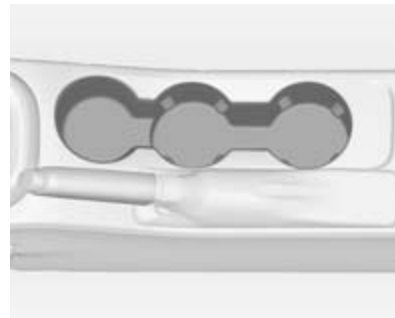

Cupholders are located in the centre console.

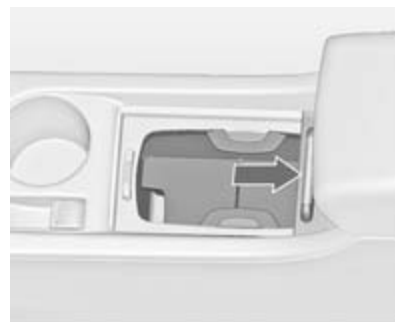

Depending on the version, cupholders are located under a cover in the centre console. Slide cover backwards. Bottles can be stowed after folding up the intermediate shelf ⇨ 54.

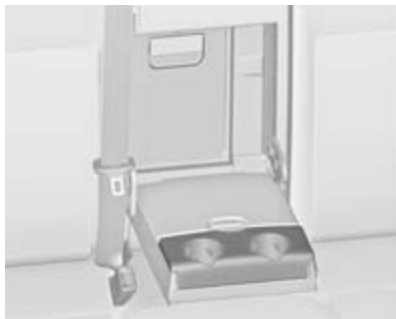

Additional cupholders are located in the rear armrest. Fold down the armrest.

## Front storage

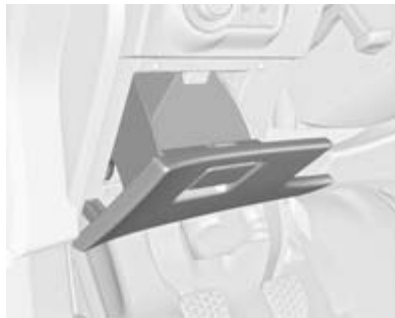

A storage compartment is located next to the steering wheel.

## Sunglasses storage

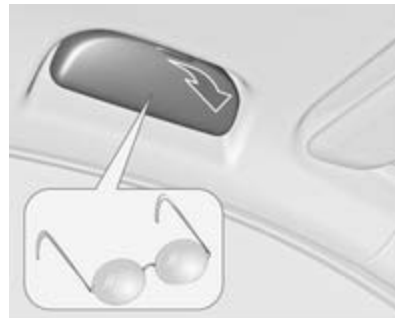

Fold down and open.

Do not use for storing heavy objects.

## Armrest storage

### Storage under the front armrest

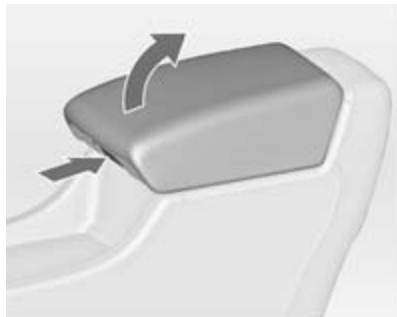

Press button to fold up the armrest. The armrest must be in rearmost position.

### Storage in the rear armrest



Fold down armrest and open cover. Close cover before folding the armrest up.

## Centre console storage

### Front console



The storage container can be used to store small items.

Depending on the version, a storage compartment is located under a cover.

Slide cover backwards.

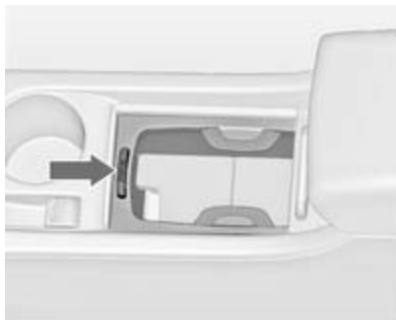

Press button to remove the frame of the cupholder. The frame can be stowed in the glovebox.

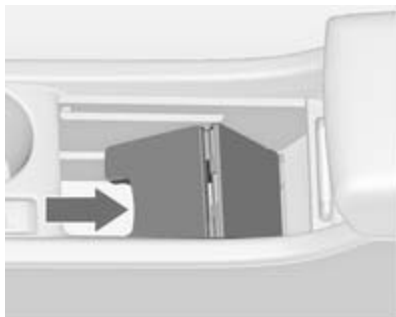

A further storage compartment is located under the intermediate shelf. Fold up the intermediate shelf and fix it in the vertical position. The frame of the cupholder can be reintegrated to stow bottles.

### Rear console



Pull out the drawer.

#### Caution

Do not use for ashes or for other glowing items.

## Load compartment

The rear seat backrest is divided into two parts. Both parts can be folded down.

### Load compartment extension

Remove the load compartment cover if necessary.

Press and hold the catch, then push the head restraints down.

Fold up the rear armrest.





Guide the seat belts through side supports to protect them against damage. When folding the backrests, pull the seat belts along with them.

Pull the release lever on one or both sides and fold down the backrests onto the seat cushion.



Take the seat belt out of the seat backrest guide and put it behind the retainer as shown in the illustration.

To fold up, raise the backrests and guide them into an upright position until they engage audibly.

Ensure that the seat belts of the outboard seats are placed in the corresponding belt guides.



The backrests are properly engaged when the red marks on both sides near the release lever are no longer visible.

### ⚠ Warning

When folding up, ensure that backrests are securely locked in position before driving. Failure to do so may result in personal injury or damage to load or vehicle in the event of heavy braking or collision.



The seat belt of the centre seat could be blocked when the backrest is folded up too quickly. To unlock the retractor, push in the seat belt or pull it out by approx. 20 mm and then let go.

## Open the pass-through in the rear centre backrest

Fold down the rear armrest.



Pull the grip and open the cover.

Suitable for loading long, narrow objects.

Ensure that the cover engages after folding up.



The closed cover can be secured from the side of the load compartment. Turn the knob 90°:

knob horizontal = cover secured from the side of the passenger compartment

knob vertical = cover not secured

## Rear storage

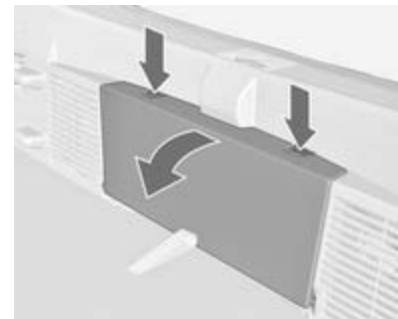

Press both buttons and fold down cover.

Maximum load: 0.5 kg.

## Load compartment cover

Do not place any objects on the cover.

## Removing



Unhook retaining straps from tailgate.

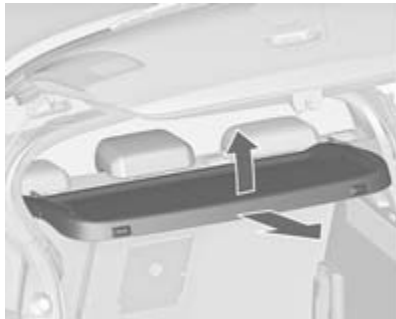

Lift cover at the rear and push it upwards at the front.

Remove the cover.

If the height adjustable cover is mounted in the middle or upper position, the load compartment cover can be stowed below it.

Height adjustable cover ⇨ 58.

## Fitting

Engage cover in side guides and fold downwards. Attach retaining straps to tailgate.

## Rear floor storage cover

### Rear floor cover

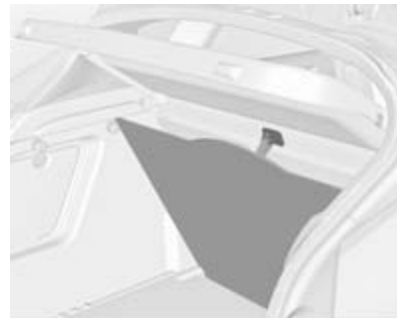

The rear floor cover can be lifted. Hinge the loop into the hook on the lower side of the load compartment cover.

### Caution

Only use the hook for hanging up the rear floor cover and the height adjustable cover.

## Height adjustable cover



The height adjustable cover can be mounted in three positions:

- directly above the rear floor cover (1),
- in a middle position (2)
- in an upper position (3).

### Caution

Ensure that the front and rear end of the height adjustable cover are attached to the same level.

## Lifting

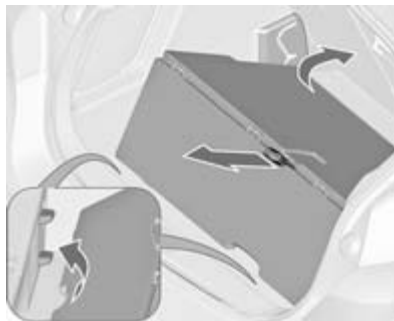

To lift the cover to a higher level, pull the loop backwards and lift the rear edge of the cover onto the corresponding supports.

## Lowering



To lower the cover, pull the strap backwards and push down the front centre of the cover at the same time.

### Caution

Do not lower the height adjustable cover to position 1 in vehicles equipped with subwoofer. The subwoofer could be damaged.

**Note**

- If mounted in position 2 or 3, the space between the rear floor cover and the height adjustable cover can be used as a stowage compartment.
- The height adjustable cover can be lifted and hooked in with the strap when it is mounted in position 1 or 2.
- If mounted in position 2, an almost completely flat load bay is created if the rear seat backrests are folded forwards.
- Opening the side covers (e.g. when exchanging the rear light bulbs) is only possible with the height adjustable cover mounted in position 1 or 2.

**Caution**

The height adjustable cover is able to withstand a load of no more than 100 kg.

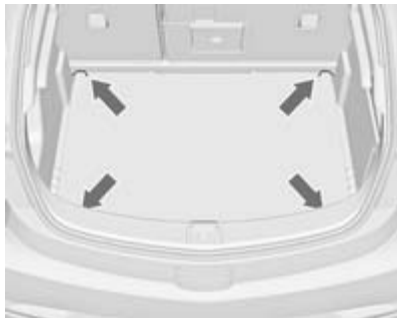
**Lashing eyes**

The lashing eyes are designed to secure items against slippage, e.g. using lashing straps or luggage net.

**Warning triangle**

Stow the warning triangle in the space behind the strap on the right side of the load compartment.

Depending on the equipment, the warning triangle can be stored in a storage compartment below the floor cover.

## First aid kit



Stow the first aid kit in the stowage compartment behind the warning triangle.

Use the recesses to fold down the cover.

Depending on the equipment, the first aid kit can be stored in the rear storage ↻ 57.

## Roof rack system

### Roof rack

For safety reasons and to avoid damage to the roof, the vehicle approved roof rack system is recommended. For further information contact your workshop.

Follow the installation instructions and remove the roof rack when not in use.

### Mounting roof rack



Detach the cover from each mounting point by using a coin.

## Loading information



- Heavy objects in the load compartment should be placed against the seat backrests. Ensure that the backrests are securely engaged. If objects can be stacked, heavier objects should be placed at the bottom.
- Secure objects with lashing straps attached to the lashing eyes ↻ 60. Attach the height adjustable cover in the lowest position ↻ 58.

- Use the four hooks at the sidewalls of the load compartment for hanging up carrier bags. Maximum load: 5 kg per hook.
- Secure loose objects in the load compartment to prevent them from sliding.
- When transporting objects in the load compartment, the backrests of the rear seats must not be angled forward.
- Do not allow the load to protrude above the upper edge of the backrests.
- Do not place any objects on the load compartment cover or the instrument panel, and do not cover the sensor on top of the instrument panel.
- The load must not obstruct the operation of the pedals, parking brake and gear selector lever, or hinder the freedom of movement of the driver. Do not place any unsecured objects in the interior.
- Do not drive with an open load compartment.

### ⚠ Warning

Always make sure that the load in the vehicle is securely stowed. Otherwise objects can be thrown around inside the vehicle and cause personal injury or damage to the load or car.

- The payload is the difference between the permitted gross vehicle weight (see identification plate ↻ 200) and the EC kerb weight.

To calculate the payload, enter the data for your vehicle in the Weights table at the front of this manual.

The EC kerb weight includes weights for the driver (68 kg), luggage (7 kg) and all fluids (tank 90 % full).

Optional equipment and accessories increase the kerb weight.

- Driving with a roof load increases the sensitivity of the vehicle to cross-winds and has a detrimental effect on vehicle handling due to

the vehicle's higher centre of gravity. Distribute the load evenly and secure it properly with retaining straps. Adjust the tyre pressure and vehicle speed according to the load conditions. Check and retighten the straps frequently.

Do not drive faster than 75 mph.

The permissible roof load is 75 kg. The roof load is the combined weight of the roof rack and the load.

## Instruments and controls

Controls .....	63
Warning lights, gauges and indicators .....	70
Information displays .....	81
Vehicle messages .....	86
Trip computer .....	90
Vehicle personalisation .....	93

### Controls

#### Steering wheel adjustment



Unlock lever, adjust steering wheel, then engage lever and ensure it is fully locked.

Do not adjust steering wheel unless vehicle is stationary and steering wheel lock has been released.

#### Steering wheel controls



The Infotainment system, the cruise control, the speed limiter and a connected mobile phone can be operated via the controls on the steering wheel.

Further information is available in the Infotainment system manual.

Cruise control ⇨ 138, Speed limiter ⇨ 139.



## Heated steering wheel



Activate heating by pressing  button. Activation is indicated by the LED in the button.



The recommended grip areas of the steering wheel are heated quicker and to a higher temperature than the other areas.

Heating is operational when the engine is running and during an Autostop.

Stop-start system  123.

## Horn



Press .

## Windscreen wiper/washer

### Windscreen wiper



- 2** = fast
- 1** = slow
-  = interval wiping
- O** = off

For a single wipe when the windscreen wiper is off, press the lever down.

Do not use if the windscreen is frozen.  
Switch off in car washes.

### Adjustable wiper interval





Wiper lever in position .

Turn the adjuster wheel to adjust the desired wipe interval:

- short interval = turn adjuster wheel upwards
- long interval = turn adjuster wheel downwards

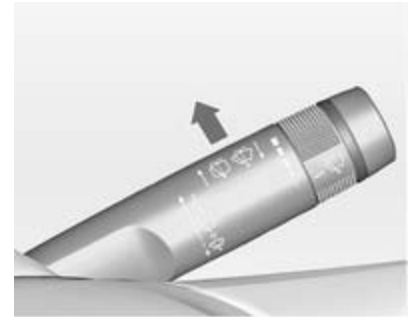
### Automatic wiping with rain sensor



 = automatic wiping with rain sensor

The rain sensor detects the amount of water on the windscreen and automatically regulates the frequency of the windscreen wiper.

If the wiper frequency is above 20 seconds the wiper arm moves slightly down to park position.

### Adjustable sensitivity of the rain sensor



Turn the adjuster wheel to adjust the sensitivity:

- |                  |   |                               |
|------------------|---|-------------------------------|
| low sensitivity  | = | turn adjuster wheel downwards |
| high sensitivity | = | turn adjuster wheel upwards   |



Keep the sensor free from dust, dirt and ice.

### Windscreen and headlight washer

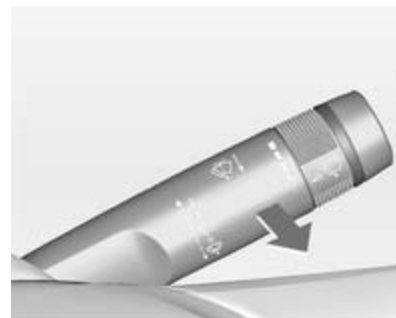

Pull lever. Washer fluid is sprayed onto the windscreen and the wiper wipes a few times.

If the headlights are on, washer fluid is also sprayed onto the headlights, provided that the lever is pulled sufficiently long. Afterwards the headlight washer system is inoperable for 5 wash cycles or until engine or headlights have been switched off and on again.

## Rear window wiper/washer

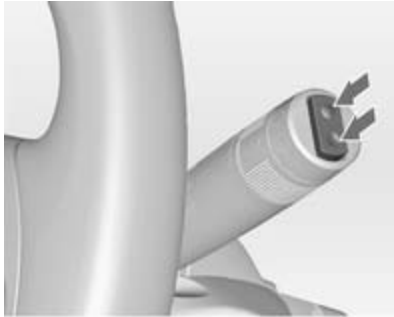

Press the rocker switch to activate the rear window wiper:

upper position	= continuous operation
lower position	= intermittent operation
middle position	= off

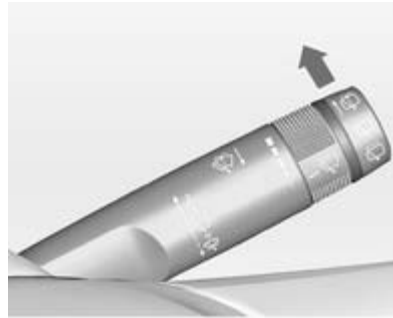

Push lever. Washer fluid is sprayed onto the rear window and the wiper wipes a few times.

Do not use if the rear window is frozen.

Switch off in car washes.

The rear window wiper comes on automatically when the windscreen wiper is switched on and reverse gear is engaged.

Activation or deactivation of this function can be changed in the menu **Settings** in the Info-Display.

Vehicle personalisation ↻ 93.

The rear window washer system is deactivated when the fluid level is low.

## Outside temperature



20153

A drop in temperature is indicated immediately and a rise in temperature after a time delay.



If outside temperature drops to 3 °C, a warning message is displayed in the Driver Information Centre with Uplevel-Display or Uplevel-Combi-Display.

### Warning

The road surface may already be icy even though the display indicates a few degrees above 0 °C.

## Clock

Date and time are shown in the Info-Display.

### Set date and time

Press the **CONFIG** button. The menu **Settings** is displayed.

Select **Time & Date**.

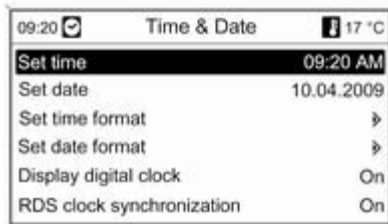

Selectable setting options:

- **Set time:** Changes the time shown on the display.
- **Set date:** Changes the date shown on the display.
- **Set time format:** Changes indication of hours between **12 hours** and **24 hours**.

- **Set date format:** Changes indication of date between **MM/DD/YYYY** and **DD.MM.YYYY**.
- **Display digital clock:** Switches on/off indication of time on the display.
- **RDS clock synchronization:** The RDS signal of most VHF transmitters automatically sets the time. RDS time synchronisation can take a few minutes. Some transmitters do not send a correct time signal. In such cases, it is recommended to switch off automatic time synchronisation.

Vehicle personalisation ⇨ 93.

## Power outlets



A 12 Volt power outlet is located in the front console.



A further 12 Volt power outlet is located in the rear console. Fold the cover downwards.

Do not exceed the maximum power consumption of 120 watts.

With ignition off, the power outlets are deactivated. Additionally the power outlets are deactivated in the event of low battery voltage.

Electrical accessories that are connected must comply with the electromagnetic compatibility requirements laid down in DIN VDE 40 839.

Do not connect any current-delivering accessories, e.g. electrical charging devices or batteries.

Do not damage the outlet by using unsuitable plugs.

Stop-start system ⇨ 123.

## Cigarette lighter



The cigarette lighter is located in the front console.

Press in cigarette lighter. It switches off automatically once the element is glowing. Pull out lighter.

## Ashtrays

### Caution

To be used only for ash and not for combustible rubbish.



The portable ashtray can be placed in the cupholders.

## Warning lights, gauges and indicators

### Instrument cluster

In some versions, the needles of the instruments briefly rotate to the end position when the ignition is switched on.

### Speedometer

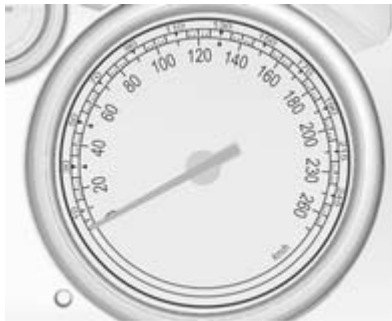

Indicates vehicle speed.

### Odometer



The bottom line displays the recorded distance in miles.

### Trip odometer

The top line displays the recorded distance since the last reset.

To reset, hold the reset knob depressed for a few seconds with the ignition on.

## Tachometer



Displays the engine speed.

Drive in a low engine speed range for each gear as much as possible.

### Caution

If the needle is in the red warning zone, the maximum permitted engine speed is exceeded. Engine at risk.

## Fuel gauge



Displays the fuel level in the tank.

Control indicator ● illuminates if the level in the tank is low. Refuel immediately if it flashes.

Never run the tank dry.

Because of the fuel remaining in the tank, the top-up quantity may be less than the specified tank capacity.

## Engine coolant temperature gauge



Displays the coolant temperature.

left area = engine operating temperature not yet reached

central area = normal operating temperature

right area = temperature too high



### Caution

If engine coolant temperature is too high, stop vehicle, switch off engine. Danger to engine. Check coolant level.

## Service display

The engine oil life system lets you know when to change the engine oil and filter. Based on driving conditions, the interval at which an engine oil and filter change will be indicated can vary considerably.

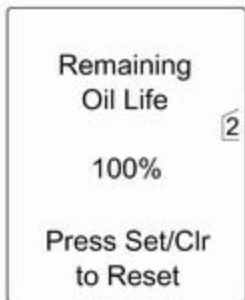

In the Uplevel-Display or Uplevel-Combi-Display, the remaining oil life duration is displayed in the **Vehicle Information Menu**.

In the Midlevel-Display, the remaining engine oil life duration is displayed by the control indicator , therefore the ignition must be switched on, with the engine not running.

The menu and function can be selected via the buttons on the turn signal lever.

To display the remaining engine oil life duration:

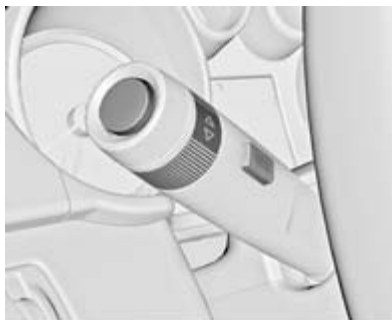

Press the **MENU** button to select the **Vehicle Information Menu**.

Turn the adjuster wheel to select **Remaining Oil Life**.

The system must be reset every time the engine oil is changed to allow proper functionality. Seek the assistance of a workshop.

Press the **SET/CLR** button to reset. Therefore the ignition must be switched on, with the engine not running.

When the system has calculated that engine oil life has been diminished, **Change Engine Oil Soon** or a warning code appears in the Driver Information Centre. Have engine oil and filter changed by a workshop within one week or 300 miles (whichever occurs first).

Driver Information Centre .

Service information .

## Control indicators

The control indicators described are not present in all vehicles. The description applies to all instrument

versions. Depending on the equipment, the position of the control indicators may vary. When the ignition is switched on, most control indicators will illuminate briefly as a functionality test.

The control indicator colours mean:

- red = danger, important reminder
- yellow = warning, information, fault
- green = confirmation of activation
- blue = confirmation of activation
- white = confirmation of activation

## Control indicators in the instrument cluster

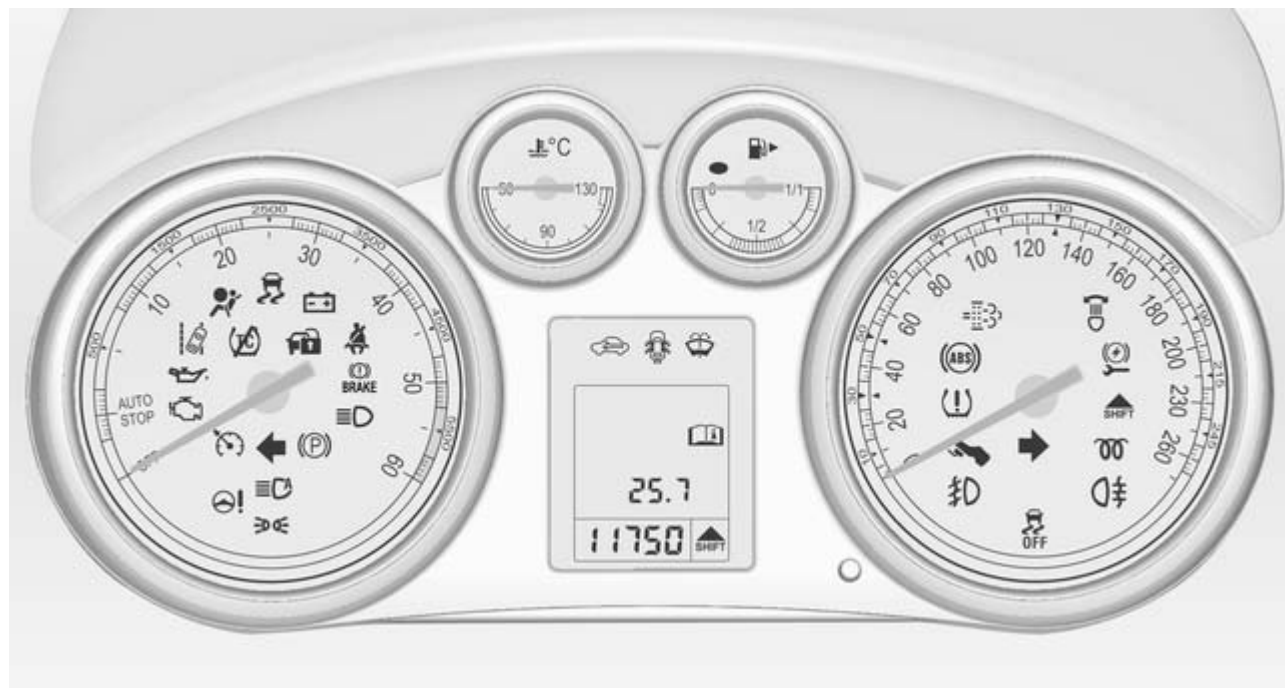

## Control indicators in the centre console



### Turn signal

↔ illuminates or flashes green.

### Illuminates briefly

The parking lights are switched on.

### Flashes

A turn signal or the hazard warning flashers are activated.

Rapid flashing: failure of a turn signal light or associated fuse, failure of turn signal light on trailer.

Bulb replacement ↗ 163, Fuses ↗ 171.

Turn signals ↗ 106.

## Seat belt reminder

### Seat belt reminder on front seats

🚗 for driver's seat illuminates or flashes red.

🚗 for front passenger seat illuminates or flashes red, when seat is occupied.

### Illuminates

After the ignition has been switched on until the seat belt has been fastened.

### Flashes

After having started the engine for a maximum of 100 seconds until the seat belt has been fastened.

## Airbag and belt tensioners

🚗 illuminates red.

When the ignition is switched on, the control indicator illuminates for approx. 4 seconds. If it does not illuminate, does not extinguish after 4 seconds or illuminates whilst driving, there is a fault in the airbag system. Seek the assistance of a workshop. The airbags and belt pretensioners may fail to trigger in the event of an accident.

Deployment of the belt pretensioners or airbags is indicated by continuous illumination of 🚗.

### ⚠ Warning

Have the cause of the fault remedied immediately by a workshop.

Belt pretensioners, airbag system ↗ 40, ↗ 42.

## Airbag deactivation

🚗 illuminates yellow.

Illuminates for approx. 60 seconds after the ignition is switched on. The front passenger airbag is activated.

 illuminates yellow.

The front passenger airbag is deactivated ⇨ 44.

### Danger

Risk of fatal injury for a child using a child restraint system together with activated front passenger airbag.

Risk of fatal injury for an adult person with deactivated front passenger airbag.

## Charging system

 illuminates red.

Illuminates when the ignition is switched on and extinguishes shortly after the engine starts.

### Illuminates when the engine is running

Stop, switch off engine. Battery is not charging. Engine cooling may be interrupted. The brake servo unit may cease to be effective. Seek the assistance of a workshop.

## Malfunction indicator light

 illuminates or flashes yellow.

Illuminates when the ignition is switched on and extinguishes shortly after the engine starts.

### Illuminates when the engine is running

Fault in the emission control system. The permitted emission limits may be exceeded. Seek the assistance of a workshop immediately.

### Flashes when the engine is running

Fault that could lead to catalytic converter damage. Ease up on the accelerator until the flashing stops. Seek the assistance of a workshop immediately.

## Service vehicle soon

 illuminates yellow.

Additionally a warning message or a warning code is displayed.

The vehicle needs a service.

Seek the assistance of a workshop. Vehicle messages ⇨ 86.

## Brake and clutch system

### Brake and clutch fluid level

 illuminates red.

The brake and clutch fluid level is too low ⇨ 159.

### Warning

Stop. Do not continue your journey. Consult a workshop.

Illuminates after the ignition is switched on if the manual parking brake is applied ⇨ 132.

### Operate pedal

 illuminates or flashes yellow.

Clutch pedal needs to be operated to start the engine. Stop-start system ⇨ 123.

**Illuminates**

Brake pedal needs to be operated to release the electrical parking brake  
 ⇨ 132.

**Flashes**

Clutch pedal needs to be operated to start the engine ⇨ 121.

**Electrical parking brake**

Ⓢ illuminates or flashes red.

**Illuminates**

Electrical parking brake is applied  
 ⇨ 132.

**Flashes**

Electrical parking brake is not fully applied or released. Switch on ignition, depress brake pedal and attempt to reset the system by first releasing and then applying the electrical parking brake. If Ⓢ remains flashing, do not drive and seek the assistance of a workshop.

**Electrical parking brake fault**

Ⓢ illuminates or flashes yellow.

**Illuminates**

Electrical parking brake is operating with degraded performance ⇨ 132.

**Flashes**

Electrical parking brake is in service mode. Stop vehicle, apply and release the electrical parking brake to reset.

**⚠ Warning**

Have the cause of the fault remedied immediately by a workshop.

**Antilock brake system (ABS)**

Ⓢ illuminates yellow.

Illuminates for a few seconds after the ignition is switched on. The system is ready for operation when the control indicator extinguishes.

If the control indicator does not extinguish after a few seconds, or if it illuminates while driving, there is a fault in the ABS. The brake system remains operational but without ABS regulation.

Antilock brake system ⇨ 131.

**Upshift**

Ⓢ illuminates green, or is shown as a symbol in the Driver Information Centre with Uplevel-Display or Uplevel-Combi-Display.

Upshifting is recommended for fuel saving.

ECO drive assistant ⇨ 90.

**Power steering**

Ⓢ illuminates yellow.

**Illuminates with power steering reduced**

Power steering is reduced due to overheating of the system. Control indicator extinguishes when the system has cooled down.

Stop-start system ⇨ 123.

### **Illuminates with power steering disabled**

Failure in the power steering system. Consult a workshop.

### **Lane departure warning**

☞ illuminates green or flashes yellow.

### **Illuminates green**

System is switched on and ready to operate.

### **Flashes yellow**

System recognises an unintended lane change.

### **Ultrasonic parking assist**

P<sup>u</sup>▲ illuminates yellow.

Fault in system

or

Fault due to sensors that are dirty or covered by ice or snow

or

Interference due to external sources of ultrasound. Once the source of interference is removed, the system will operate normally.

Have the cause of the fault in the system remedied by a workshop.

Ultrasonic parking assist ⇨ 141.

### **Electronic Stability Control off**

☞ illuminates yellow.

The system is deactivated.

### **Electronic Stability Control and Traction Control system**

☞ illuminates or flashes yellow.

### **Illuminates**

A fault in the system is present. Continued driving is possible. Driving stability, however, may deteriorate depending on road surface conditions.

Have the cause of the fault remedied by a workshop.

### **Flashes**

The system is actively engaged. Engine output may be reduced and the vehicle may be braked automatically to a small degree.

Electronic Stability Control ⇨ 134, Traction Control system ⇨ 134.

### **Traction Control system off**

☞ illuminates yellow.

The system is deactivated.

### **Preheating**

☞ illuminates yellow.

Preheating is activated. Only activates when outside temperature is low.

### **Diesel particle filter**

☞ illuminates or flashes yellow.

The diesel particle filter requires cleaning.

Continue driving until  extinguishes. If possible, do not allow engine speed to drop below 2000 rpm.

### Illuminates

The diesel particle filter is full. Start cleaning process as soon as possible.

### Flashes

The maximum filling level of the filter is reached. Start cleaning process immediately to avoid damage to the engine.

Diesel particle filter  125, Stop-start system  123.

## Tyre pressure monitoring system

 illuminates or flashes yellow.

### Illuminates

Tyre pressure loss. Stop immediately and check tyre pressure.

### Flashes

Fault in system or tyre without pressure sensor mounted (e.g. spare wheel). After 60-90 seconds the control indicator illuminates continuously. Consult a workshop.

## Engine oil pressure

 illuminates red.

Illuminates when the ignition is switched on and extinguishes shortly after the engine starts.

### Illuminates when the engine is running

#### Caution

Engine lubrication may be interrupted. This may result in damage to the engine and/or locking of the drive wheels.

1. Depress clutch.
2. Select neutral gear, set selector lever to **N**.

3. Move out of the flow of traffic as quickly as possible without impeding other vehicles.
4. Switch off ignition.

#### Warning

When the engine is off, considerably more force is needed to brake and steer. During an Autostop the brake servo unit will still be operational.

Do not remove key until vehicle is stationary, otherwise the steering wheel lock could engage unexpectedly.

Check oil level before seeking the assistance of a workshop  157.

## Low fuel

 illuminates or flashes yellow.

### Illuminates

Level in fuel tank is too low.



## Flashes

Fuel used up. Refuel immediately.

Never run the tank dry.

Catalytic converter ↻ 126.

Bleeding the diesel fuel system

↻ 162.

## Immobiliser

🔒 flashes yellow.

Fault in the immobiliser system. The engine cannot be started.

## Reduced engine power

⚠️ illuminates yellow.

The engine power is limited. Consult a workshop.

## Exterior light

➡️ illuminates green.

The exterior lights are on ↻ 99.

## High beam

☰D illuminates blue.

Illuminates when high beam is on, during headlight flash ↻ 100, or when high beam is on with high beam assist or intelligent light range ↻ 102.

## High beam assist

☰C illuminates green.

The high beam assist or intelligent light range is activated ↻ 100, ↻ 102.

## Adaptive forward lighting

⚡ illuminates or flashes yellow.

## Illuminates

Fault in system.

Seek the assistance of a workshop.

## Flashes

System switched to symmetrical low beam.

Control indicator ⚡ flashes for approx. 4 seconds after the ignition is switched on as a reminder that the system has been activated ↻ 102.

Automatic light control ↻ 100.

## Fog light

☁️D illuminates green.

The front fog lights are on ↻ 106.

## Rear fog light

☁️R illuminates yellow.

The rear fog light is on ↻ 107.

## Low washer fluid

🚿 illuminates yellow.

The washer fluid level is low.

Washer fluid ↻ 159.

## Cruise control

🚗 illuminates white or green.

## Illuminates white

The system is on.

## Illuminates green

Cruise control is active.

Cruise control ↻ 138.

## Door open

☞ illuminates red.

A door or the tailgate is open.

## Information displays

### Driver Information Centre



The Driver Information Centre (DIC) is located in the instrument cluster between speedometer and tachometer. It is available as Midlevel-Display, Uplevel-Display or Uplevel-Combi-Display.

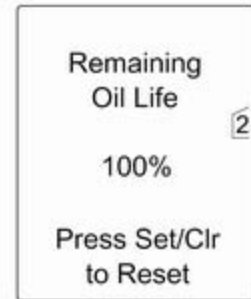

In the Uplevel-Display the following main menus can be selected by the **MENU** button:

- **Vehicle Information Menu**
- **Trip/Fuel Information Menu**
- **Performance Menu**



In the Uplevel-Combi-Display, the menus can be selected by the **MENU** button, indicated by symbols in the top line of the display:

- = **Vehicle Information Menu**
- = **Trip/Fuel Information Menu**

Some of the displayed functions differ between vehicle driving and standstill and some functions are only active when the vehicle is driving.

Vehicle personalisation ⇨ 93.

Memorised settings ⇨ 21.

### Selecting menus and functions

The menus and functions can be selected via the buttons on the turn signal lever.



Press the **MENU** button to switch between the menus or to return from a submenu to the next higher menu level.



Turn the adjuster wheel to highlight a menu option or to set a numeric value.



Press the **SET/CLR** button to select a function or to confirm a message.

### Vehicle Information Menu

Press the **MENU** button to select the **Vehicle Information Menu**, or on Uplevel-Combi-Display select .

Turn the adjuster wheel to select one of the submenus. Press the **SET/CLR** button to confirm.



Follow the instructions given in the submenus.

Possible submenus for the following functions:

- **Unit:** displayed units can be changed
- **Tyre Pressure:** checks tyre pressure of all wheels during driving ⇨ 178
- **Remaining Oil Life:** indicates when to change the engine oil and filter ⇨ 72
- **Speed Warning:** if exceeding the preset speed, a warning chime will be activated
- **Traffic Sign Assistant:** displays detected traffic signs for the current route section ⇨ 143
- **Following Distance Indication:** displays the distance to a preceding moving vehicle ⇨ 140



Selection and indication can be different between Midlevel-, Uplevel-, and Uplevel-Combi-Display.

### Trip/Fuel Information Menu

Press the **MENU** button to select the **Trip/Fuel Information Menu**, or select  on Uplevel-Combi-Display.

Turn the adjuster wheel to select one of the submenus. Press the **SET/CLR** button to confirm.



- Trip odometer 1
- Trip odometer 2
- Digital speed

Trip odometer 2 and digital speed are only available on vehicles with Uplevel-Display or Uplevel-Combi-Display.

On vehicles with trip computer more submenus are available.

Trip/Fuel Information Menu, Trip Computer ↻ 90.

ECO drive assist ↻ 90.

## Performance Menu



Submenus are:

- **Oil Temp.:** Display of oil temperature.
- **Oil Pres.:** Display of oil pressure.
- **Boost Pres.:** Display of turbo boost pressure.
- **Lap Timer:** Display of lap times, top speed, average speed and average time. Follow the instructions given in the submenu.
- **Coolant Temp.:** Display of coolant temperature.

- **Battery Volt.:** Display of battery voltage.
- **Acceleration:** Display of current acceleration in all directions.

## Graphic-Info-Display, Colour-Info-Display

Depending on the vehicle configuration the vehicle has a Graphic- or Colour-Info-Display. The Info-Display is located in the instrument panel above the Infotainment system.

### Graphic-Info-Display

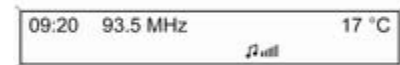

Depending on the Infotainment system, the Graphic-Info-Display is available in two versions.



20153

Graphic-Info-Display indicates:

- time ↪ 68
- outside temperature ↪ 67
- date ↪ 68
- Infotainment system, see description in the Infotainment system manual
- settings for vehicle personalisation ↪ 93

## Colour-Info-Display



The Colour-Information-Display indicates in colour:

- time ↪ 68
- outside temperature ↪ 67
- date ↪ 68
- Infotainment system, see description in the Infotainment system manual
- navigation, see description in the Infotainment system manual
- system settings

- vehicle messages ↪ 86
- settings for vehicle personalisation ↪ 93

The type of information and how it is displayed depends on the equipment of the vehicle and the settings made.

## Selecting menus and settings

Menus and settings are accessed via the display.



Selections are made via:

- menus
- function buttons and multifunction knob of the Infotainment system

### Selecting with the Infotainment system



Select a function via the Infotainment system buttons. The menu of the selected function is displayed.

The multifunction knob is used to select an item and to confirm.

#### Multifunction knob

The multifunction knob is the central control element for the menus:

#### Turn

- To mark a menu option
- To set a numeric value or to display a menu option

#### Press (the outer ring)

- To select or activate the marked option
- To confirm a set value
- To switch a system function on/off

#### BACK button

Press button to:

- exit a menu without changing settings
- return from a submenu to a higher menu level
- delete the last character in a character sequence

Press and hold the button for a few seconds to delete the entire entry.

Vehicle personalisation ⇄ 93.

Memorised settings ⇄ 21.

### Smartphone controller

The smartphone controller allows a smartphone to access vehicle data via WLAN or Bluetooth connection.

This data can then be displayed and analysed on the smartphone.

### Vehicle messages

Messages are indicated mainly in the Driver Information Centre (DIC), in some cases together with a warning and signal buzzer.

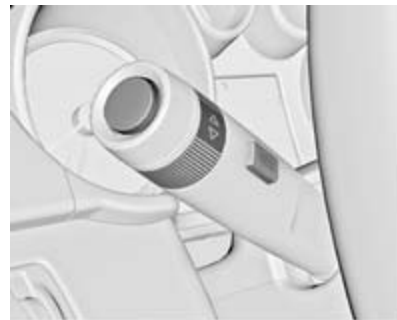

Press the **SET/CLR** button, the **MENU** button or turn the adjuster wheel to confirm a message.

## Vehicle messages on the Midlevel-Display



The vehicle messages are displayed as code numbers.

### No. Vehicle message

- 2 No radio remote control detected, depress clutch pedal for a restart
- 3 Engine coolant level low
- 4 Air conditioning off
- 5 Steering wheel is locked

### No. Vehicle message

- 6 Depress brake pedal to release electrical parking brake
- 7 Turn steering wheel, switch ignition off and then on
- 9 Turn steering wheel, start engine again
- 12 Vehicle overloaded
- 13 Compressor overheated
- 15 Centre high-mounted brake light failure
- 16 Brake light failure
- 17 Headlight levelling malfunction
- 18 Left low beam failure
- 19 Rear fog light failure
- 20 Right low beam failure
- 21 Left sidelight failure
- 22 Right sidelight failure
- 23 Reversing light failure

### No. Vehicle message

- 24 Number plate light failure
- 25 Left front turn signal failure
- 26 Left rear turn signal failure
- 27 Right front turn signal failure
- 28 Right rear turn signal failure
- 29 Check trailer brake light
- 30 Check trailer reversing light
- 31 Check left trailer turn signal
- 32 Check right trailer turn signal
- 33 Check trailer rear fog light
- 34 Check trailer rear light
- 35 Replace battery in radio remote control
- 48 Clean side blind zone alert system
- 49 Lane departure warning unavailable
- 53 Tighten gas cap



**No. Vehicle message**

- 54 Water in diesel fuel filter
- 55 Diesel particle filter is full  
↻ 125
- 56 Tyre pressure imbalance on front axle
- 57 Tyre pressure imbalance on rear axle
- 58 Tyres without TPMS sensors detected
- 59 Open and then close driver window
- 60 Open and then close front passenger window
- 61 Open and then close rear left window
- 62 Open and then close rear right window
- 65 Theft attempted
- 66 Service theft alarm system
- 67 Service steering wheel lock

**No. Vehicle message**

- 68 Service power steering
- 69 Service suspension system
- 70 Service level control system
- 71 Service rear axle
- 74 Service AFL
- 75 Service air conditioning
- 76 Service side blind zone alert system
- 77 Service lane departure warning
- 78 Service pedestrian protection system
- 79 Top up engine oil
- 81 Service transmission
- 82 Change engine oil soon
- 83 Service adaptive cruise control
- 84 Engine power is reduced
- 94 Shift to park before exiting

**No. Vehicle message**

- 95 Service airbag
- 128 Bonnet open
- 134 Park assist fault, clean bumper
- 136 Service parking assist
- 145 Check washer fluid level
- 174 Low battery
- 258 Park assist off

## Vehicle messages on the Uplevel-Display or Uplevel-Combi-Display



The vehicle messages are displayed as text. Follow the instructions given in the messages.

The system displays messages regarding the following topics:

- Fluid levels
- Anti-theft alarm system
- Brakes
- Drive systems
- Ride control systems

- Cruise control
- Object detection systems
- Lighting, bulb replacement
- Wiper/washer system
- Doors, windows
- Radio remote control
- Seat belts
- Airbag systems
- Engine and transmission
- Tyre pressure
- Diesel particle filter
- Battery

## Vehicle messages on the Colour-Info-Display

Some important messages appear additionally in the Colour-Info-Display. Press the multifunction knob to confirm a message. Some messages only pop up for a few seconds.

## Warning chimes

### When starting the engine or whilst driving

Only one warning chime will sound at a time.

The warning chime regarding unfastened seat belts has priority over any other warning chime.

- If seat belt is not fastened.
- If a door or the tailgate is not fully closed when starting off.
- If a certain speed is exceeded with parking brake applied.
- If a programmed speed or speed limit is exceeded.
- If a warning message or a warning code appears in the Driver Information Centre.
- If the parking assist detects an object.
- If unintended lane change occurs.
- If the reverse gear is engaged and the rear end carrier extended.
- If the diesel particle filter has reached the maximum filling level.

### When the vehicle is parked and/ or the driver's door is opened

- When the key is in the ignition switch.
- With exterior lights on.

### During an Autostop

- If the driver's door is opened.

## Battery voltage

When the battery voltage is running low, a warning message or warning code 174 will appear in the Driver Information Centre.

1. Switch off immediately electrical consumers which are not required for a safe ride, such as seat heating, heated rear window or other main consumers.
2. Charge the battery by driving continuously for a while or by using a charging device.

The warning message or warning code will disappear after the engine has been started two times consecutively without voltage drop.

If the battery cannot be recharged, have the cause of the fault remedied by a workshop.

## Trip computer

The menus and functions can be selected via the buttons on the turn signal lever.



Press the **MENU** button to select the **Trip/Fuel Information Menu**, or select  $\leftarrow$  on the Uplevel-Combi-Display.



### Trip/Fuel Information Menu on Uplevel-Display

Turn the adjuster wheel to select one of the submenus:

Trip 1 <span style="float: right;">1</span>
2120.4 km
12553

- Trip odometer 1
- Trip odometer 2
- Range
- Average consumption
- Instantaneous consumption
- Average speed
- Digital speed
- Traffic sign assistant

### Trip/Fuel Information Menu on Uplevel-Combi-Display

Turn the adjuster wheel to select the submenu:

1	2781.2 km
	$6.5 \frac{L}{100km}$
$\emptyset$	99.6 km/h
20201	

- Trip odometer 1

- Average consumption 1
- Average speed 1

2	563.2 km
	$7.8 \frac{L}{100km}$
$\emptyset$	103.5 km/h
N	002915

- Trip odometer 2
- Average consumption 2
- Average speed 2



- Digital speed
- Range
- Instantaneous consumption

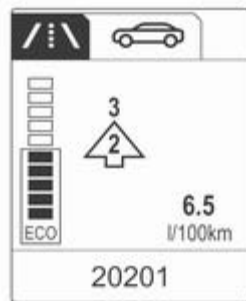

- ECO drive assistant

### Trip computer 1 and 2

The information of two trip computers can be reset separately for odometer, average consumption and average speed, making it possible to display different trip information for different drivers.

To reset, press the **SET/CLR** button in each mode for a few seconds.



### Trip odometer

Trip odometer displays the recorded distance since a certain reset.

### Range

Range is calculated from current fuel tank content and current consumption. The display shows average values.

After refuelling, the range is updated automatically after a brief delay.

When the fuel level in the tank is low, a message appears on vehicles with Uplevel-Display or Uplevel-Combi-Display.

When the tank has to be refuelled immediately, a warning code or warning message is displayed on vehicles with Midlevel- and Uplevel-Display or Uplevel-Combi-Display.

Additionally the control indicator  in the fuel gauge illuminates or flashes ⇨ 79.

### Average consumption

Display of average consumption. The measurement can be reset at any time and starts with a default value.

To reset, press the **SET/CLR** button for a few seconds.

### Instantaneous consumption

Display of the instantaneous consumption.

### Average speed

Display of average speed. The measurement can be reset at any time.

To reset, press the **SET/CLR** button for a few seconds.

### Digital speed

Digital display of the instantaneous speed.

### Traffic sign assistant

Indicates detected traffic signs for the current route section ⇨ 143.

### ECO drive assistant

An arrow indicates a recommended upshifting for fuel saving.

Additionally a bar indicates if the current driving is economical. A full bar indicates most economical driving.

## Vehicle personalisation

The vehicle's behaviour can be personalised via changing the settings in the Info-Display.

Some of the personal settings for different drivers can be memorised individually for each vehicle key. Memorised settings ⇨ 21.

Depending on vehicle equipment and country-specific regulations some of the functions described below might not be available.

Some functions are only displayed or active when the engine is running.

## Personal settings in the Graphic-Info-Display



Press the **CONFIG** button. The menu **Settings** is displayed.

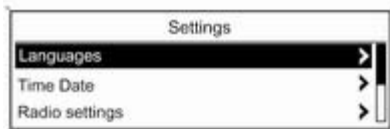

The following settings can be selected by turning and pressing the multifunction knob:

- **Sport mode settings**
- **Languages**
- **Time Date**
- **Radio settings**
- **Phone settings**
- **Vehicle settings**

In the corresponding submenus the following settings can be changed:

### Sport mode settings

The driver can select the functions which will be activated in Sport mode ⇨ 135.

- **Sport suspension:** Damping becomes harder.
- **Sport powertrain performance:** Accelerator pedal and gear change characteristics become more responsive.
- **Sport steering:** Steering support is reduced.
- **Swap backlight colour main instr.:** Change of instrument illumination colour.

### Languages

Selection of the desired language.

### Time Date

See Clock ⇨ 68.

### Radio settings

See description for Infotainment system in the Infotainment system manual.

## Phone settings

See description for Infotainment system in the Infotainment system manual.

## Vehicle settings

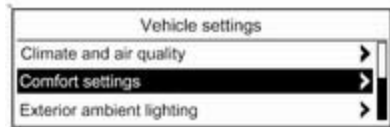

### ■ Climate and air quality

**Auto fan speed:** Modifies the fan regulation. Changed setting will be active after switching the ignition off and on again.

**Climate control mode:** Activates or deactivates the cooling every time the ignition is switched on or uses the last chosen setting.

**Auto demist:** Supports windscreen dehumidification by automatically selecting the necessary settings and auto air conditioning mode.

**Auto rear demist:** Activates automatically rear heated window.

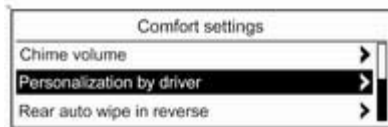

### ■ Comfort settings

**Chime volume:** Changes the volume of warning chimes.

**Personalization by driver:** Activates or deactivates the personalisation function.

**Rear auto wipe in reverse:** Activates or deactivates automatically switching on of the

rear window wiper when reverse gear is engaged.

### ■ Park assist / Collision detection

**Park assist:** Activates or deactivates the ultrasonic parking assist.

### ■ Exterior ambient lighting

**Duration upon exit of vehicle:** Activates or deactivates and change the duration of exit lighting.

**Exterior lighting by unlocking:** Activates or deactivates the welcome lighting.

### ■ Power door locks

**Auto door unlock:** Activates or deactivates the automatic door unlocking function after switching off ignition.

**Auto door lock:** Activates or deactivates the automatic door locking function after driving off.

**Stop door lock if door open:** Activates or deactivates the automatic door locking function while a door is open.



**Delayed door lock:** Activates or deactivates the delayed door locking function.

■ **Remote locking, unlocking, starting**

**Remote unlock feedback:** Activates or deactivates the hazard warning flasher feedback whilst unlocking.

**Remote door unlock:** Changes the configuration to unlock only the driver's door or the whole vehicle whilst unlocking.

**Auto relock doors:** Activates or deactivates the automatic relock function after unlocking without opening the vehicle.

■ **Restore factory settings**

**Restore factory settings:** Reset all settings to the default settings.

## Personal settings in the Colour-Info-Display



Press the **CONFIG** button. The menu **Settings** is displayed.



The following settings can be selected by turning and pressing the multifunction knob:

- **Sport mode settings**
- **Languages**
- **Time & Date**
- **Radio settings**
- **Phone settings**
- **Navigation settings**
- **Vehicle settings**
- **Display settings**

In the corresponding submenus the following settings can be changed:

### Sport mode settings

The driver can select the functions which will be activated in Sport mode ↗ 135.

- **Sport suspension:** Damping becomes harder.
- **Sport powertrain performance:** Accelerator pedal and gear change characteristics become more responsive.
- **Sport steering:** Steering support is reduced.
- **Swap backlight colour main instr.:** Change of instrument illumination colour.

### Languages

Selection of the desired language.

### Time & Date

See Clock ↗ 68.

### Radio settings

See description for Infotainment system in the Infotainment system manual.

### Phone settings

See description for Infotainment system in the Infotainment system manual.

### Navigation settings

See description for Infotainment system in the Infotainment system manual.

### Vehicle settings

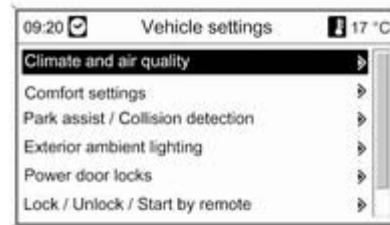

- **Climate and air quality**

**Auto fan speed:** Modifies the fan regulation. Changed setting will be active after switching the ignition off and on again.

**Climate control mode:** Activates or deactivates cooling when switching on the ignition or uses the last chosen setting.

**Auto demist:** Supports windscreen dehumidification by automatically selecting the necessary settings and auto air conditioning mode.

**Auto rear demist:** Activates automatically the rear heated window.

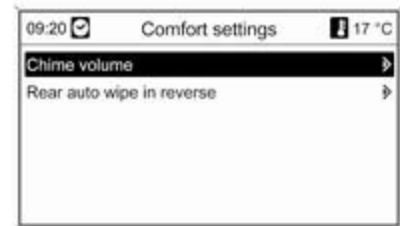

- **Comfort settings**

**Chime volume:** Changes the volume of warning chimes.

**Rear auto wipe in reverse:**

Activates or deactivates automatically switching on of the rear window wiper when reverse gear is engaged.

**■ Park assist / Collision detection**

**Park assist:** Activate or deactivate the ultrasonic parking assist.

**■ Exterior ambient lighting****Duration upon exit of vehicle:**

Activates or deactivates and changes the duration of exit lighting.

**Exterior lighting by unlocking:**

Activates or deactivates the welcome lighting.

**■ Power door locks**

**Auto door unlock:** Activates or deactivates the automatic door unlocking function after switching off ignition.

**Auto door lock:** Activates or deactivates the automatic door locking function after driving off.

**Prevent doorlock while door open:**

Activates or deactivates the

automatic door locking function while a door is open.

**■ Lock / Unlock / Start by remote**

**Remote unlock feedback:** Activates or deactivates the hazard warning flasher feedback whilst unlocking.

**Remote door unlock:** Changes the configuration to unlock only the driver's door or the whole vehicle whilst unlocking.

**Auto relock doors:** Activates or deactivates the automatic relock function after unlocking without opening the vehicle.

**■ Restore factory settings**

**Restore factory settings:** Resets all settings to the default settings.

**Display settings**

Selectable display settings:

■ **Day mode:** Optimisation for daylight conditions.

■ **Night mode:** Optimisation for darkness.

■ **Automatic mode:** The display changes mode when the vehicle lights are switched on/off.

# Lighting

Exterior lighting ..... 99  
 Interior lighting ..... 108  
 Lighting features ..... 109

## Exterior lighting

### Light switch



Turn light switch:

- 0** = lights off
- ☞☞** = sidelights
- ☞☞☞** = headlights

Control indicator ☞☞ ⇨ 80.

### Light switch with Automatic light control



Turn light switch:

- AUTO** = automatic light control: Headlights are switched on and off automatically depending on external lighting conditions.
- ☞** = activation or deactivation of the automatic light control. Switch turns back to **AUTO**.
- ☞☞** = sidelights
- ☞☞☞** = headlights

In the Driver Information Centre with Uplevel-Display or Uplevel-Combi-Display, the current status of the automatic light control is displayed.

When switching on the ignition, automatic light control is active.

When headlights are on,  $\Rightarrow$  lights up. Control indicator  $\Rightarrow$   $\rightarrow$  80.

### Tail lights

Tail lights are illuminated together with headlights and sidelights.

### Automatic light control



When the automatic light control function is switched on and the engine is running, the system switches between daytime running light and headlights automatically depending on the lighting conditions and information given by the rain sensor system.

### Daytime running light

Daytime running light increases visibility of the vehicle during daylight.

### Automatic headlight activation

During poor lighting conditions the headlights are switched on.

Furthermore the headlights are switched on if the windscreen wipers have been activated for several wipes.

### Tunnel detection

When a tunnel is entered the headlights are switched on without any delay.

Adaptive forward lighting  $\rightarrow$  102.

### High beam

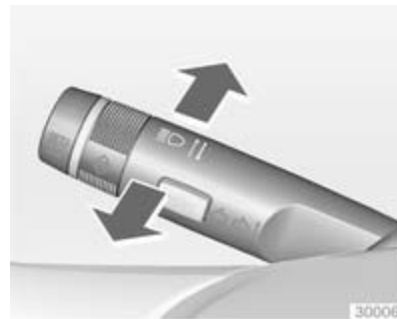

To switch from low to high beam, push lever.

To switch to low beam, push lever again or pull.

### High beam assist

This feature allows high beam as main driving light by night and when vehicle speed is faster than 25 mph.

It switches to low beam when:



- a sensor detects the lights of oncoming or preceding vehicles
- the vehicle speed is slower than 12 mph
- it is foggy or snowy
- driving in urban areas

If there are no restrictions detected, the system switches back to high beam.

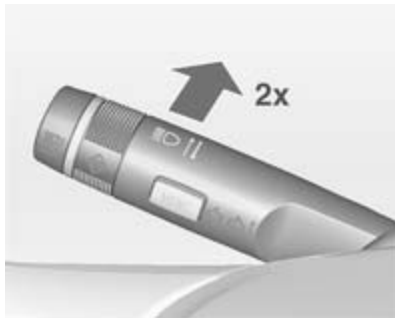
## Activation



The high beam assist is activated by pushing the indicator lever twice with a speed above 25 mph.

The green control indicator  illuminates continuously when the assist is activated, the blue one  illuminates when high beam is on. Control indicator   $\rightarrow$  80.

## Deactivation

Push indicator lever once. It is also deactivated when front fog lights are switched on.

If a headlight flash is activated when the high beam is on, the high beam assist will be deactivated.

If a headlight flash is activated when the high beam is off, the high beam assist will stay activated.

The latest setting of the high beam assist will remain after the ignition is switched on again.

## Headlight flash

To activate the headlight flash, pull lever.

## Headlight range adjustment

### Manual headlight range adjustment



To adapt headlight range to the vehicle load to prevent dazzling: turn thumb wheel  to required position.

- 0 = front seats occupied
- 1 = all seats occupied
- 2 = all seats occupied and load compartment laden
- 3 = driver's seat occupied and load compartment laden.

Dynamic automatic headlight levelling ↗ 102.

## Headlights when driving abroad

The asymmetrical headlight beam extends visibility at the edge of the road at the passenger side.

However, when driving in countries where traffic drives on the opposite side of the road, adjust the headlights to prevent dazzling of oncoming traffic.

## Vehicles with halogen headlight system

The headlights do not have to be adjusted.

## Vehicles with Xenon headlight system



1. Key in ignition switch.
2. Pull turn signal lever and hold (headlight flash).
3. Switch on ignition.
4. After approx. 5 seconds the control indicator ⚡ starts flashing and an acoustic signal sounds.

Control indicator ⚡ ↗ 80.

Every time the ignition is switched on, ⚡ flashes as a reminder for approx. 4 seconds.

For deactivation operate the same procedure as described above. ⚡ will not flash when function is deactivated.

## Adaptive forward lighting

The Adaptive forward lighting functions are only available with Bi-Xenon headlights. Light range, light distribution and intensity of light are variably triggered depending on the light conditions, weather and road type.

With the light switch in position **AUTO** all lighting functions are available.

The following functions are available also with light switch in position ⚡D:

- Dynamic curve lighting
- Cornering light
- Reversing function
- Dynamic automatic headlight levelling

### Playstreet lighting

Activated automatically at low speed up to approx. 20 mph. The light beam is turned at an angle of 8° to the roadside.

### Town lighting

Activated automatically at a speed range between approx. 25 and 34 mph and when street lights are detected by the light sensor. The light range is reduced by an extended light distribution.

### Country lighting

Activated automatically at a speed range between approx. 34 and 70 mph. The beam of light and the brightness is different between the left and the right side.

### Motorway lighting

Activated automatically at a speed above approx. 70 mph and minimal steering movements. It switches on after a delay or directly when the vehicle is powerfully accelerated. The light beam is longer and brighter.

### Adverse weather lighting

Activated automatically up to a speed of approx. 43 mph, when the rain sensor recognises condensation or the wiper operates continuously. The range, distribution and light intensity is regulated variably depending on visibility.

### Dynamic curve lighting



The light beam pivots based on steering wheel angle and speed, improving lighting in curves.

Control indicator  $\curvearrowright$   $\curvearrowleft$  80.

### Corner lighting



On tight bends or when turning off, depending on the steering angle or the turn signal light, an additional left or right reflector is switched on which illuminates the road at a right angle to the direction of travel. It is activated up to a speed of 25 mph.

Control indicator  $\curvearrowright$   $\curvearrowleft$  80.

### Reversing function

If the headlights are on and reverse gear is engaged, both corner lights are switched on. They remain illuminated for 20 seconds after disengaging reverse gear or until driving faster than 10 mph in a forward gear.



## High beam assist

This feature allows high beam as main driving light by night and when vehicle speed is faster than 25 mph.

It switches to low beam when:



- the camera in the windscreen detects the lights of oncoming or preceding vehicles
- the vehicle speed is slower than 12 mph
- it is foggy or snowy
- driving in urban areas

If there are no restrictions detected, the system switches back to high beam.

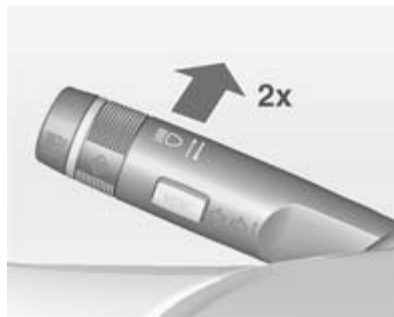
## Activation



The high beam assist is activated by pushing the indicator lever twice with a speed above 25 mph.

The green control indicator  illuminates continuously when the assist is activated, the blue one  illuminates when high beam is on.

Control indicator   80.

## Deactivation

Push indicator lever once. It is also deactivated when front fog lights are switched on.

If a headlight flash is activated when the high beam is on, the high beam assist will be deactivated.

If a headlight flash is activated when the high beam is off, the high beam assist will stay activated.

High beam assist is always active after the ignition is switched on.

## Intelligent light ranging with automatic high beam activation

Intelligent light ranging uses the properties of Bi-Xenon headlights to extend the light range of the low beam by up to 400 metres and additionally activates automatic high beam without dazzling or disturbing oncoming or preceding traffic.

High beam is deactivated and the low beam light range is reduced to avoid dazzling when the following restrictions are detected by the front camera in the windscreen:

- a preceding vehicle is recognised,
- an oncoming vehicle is recognised,
- urban areas are entered,
- it is foggy or snowy.

If there are no restrictions detected, the system switches back to high beam.

When the system is active, the front camera monitors the area ahead of the vehicle and ensures an optimum light distribution for maximum driver vision during almost all conditions.

Intelligent light ranging with automatic high beam activation therefore reduces the difference between conventional low and high beam without drastic changes in light-range, distribution and intensity.

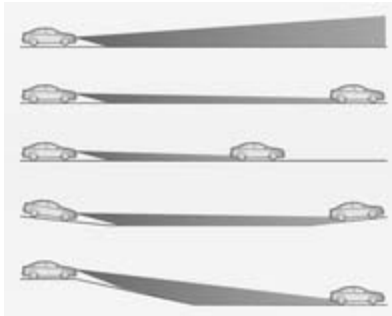

A special topographical evaluation function detects preceding vehicles on hills or slopes by recognising the rear light moving ahead. The system adjusts the height of the light range to ensure optimum illumination on the road ahead without dazzling.

### Activation

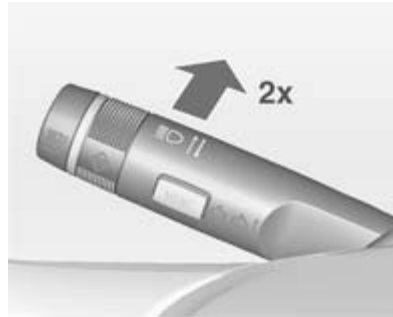

Intelligent light ranging and automatic high beam activation are switched on together by pushing the indicator lever twice. They can be switched on with ignition on.

Automatic high beam activation operates at a speed above 25 mph and deactivates below 12 mph. Intelligent light ranging operates above 35 mph.

The green control indicator  $\equiv \text{D}$  illuminates continuously when the function is activated, the blue one  $\equiv \text{D}$  illuminates when high beam switches on automatically.

### Deactivation

Push indicator lever once. It is also deactivated when front fog lights are switched on.

### Dynamic automatic headlight levelling

To prevent oncoming traffic from dazzle, headlight levelling is automatically adjusted based on inclination information measured by front and rear axle, acceleration or deceleration and vehicle speed.

### Fault in Adaptive forward lighting system

When the system detects a failure in the Adaptive forward lighting system, the system moves to a preset position to avoid dazzling of oncoming traffic. If this is not possible, the affected headlight will be automatically switched off. In any case, one headlight will stay on. A warning is displayed in the Driver Information Centre.

### Hazard warning flashers



Operated with the  button.

In the event of an accident with airbag deployment the hazard warning flashers are activated automatically.

### Turn and lane-change signals



lever up = right turn signal  
 lever down = left turn signal

If the lever is moved past the resistance point, the turn signal is switched on constantly. When the steering wheel moves back, the turn signal is automatically deactivated.

For three flashes, e.g. when changing lanes, press the lever until resistance is felt and then release.

When a trailer is connected, turn signal flashes six times when pressing the lever until resistance is felt and then releasing.

Move the lever to the resistance point and hold for longer indication.

Switch the turn signal off manually by moving the lever to its original position.

### Front fog lights



Operated with the  button.

Light switch in position **AUTO**: switching on front fog lights will switch headlights on automatically.

## Rear fog lights



Operated with the  button.

Light switch in position **AUTO**: switching on rear fog light will switch headlights on automatically.

Light switch in position : rear fog light can only be switched on with front fog lights.

The vehicle rear fog light is deactivated when towing.

## Parking lights



When the vehicle is parked, the parking lights on one side can be activated:

1. Switch off ignition.
2. Move turn signal lever all the way up (right parking lights) or down (left parking lights).

Confirmed by a signal and the corresponding turn signal control indicator.

## Reversing lights

The reversing light comes on when the ignition is on and reverse gear is selected.

## Misted light covers

The inside of the light housing may mist up briefly in poor, wet and cold weather conditions, in heavy rain or after washing. The mist disappears quickly by itself; to help switch on the headlights.

## Interior lighting

### Instrument panel illumination control



Brightness of the following lights can be adjusted when the exterior lights are on:

- Instrument panel illumination
- Info-Display
- Illuminated switches and operation elements.

Turn thumb wheel  and hold until the desired brightness is obtained.

On vehicles with light sensor, the brightness can only be adjusted when the exterior lights are on and the light sensor detects night conditions.

### Interior lights

During entry and exit of the vehicle, the front and rear courtesy lights automatically switch on and then off after a delay.

#### Note

In the event of an accident with airbag deployment the courtesy lights are turned on automatically.

### Front courtesy light



Operate rocker switch:

 = automatic switching on and off.

press  = on.

press  = off.

### Courtesy light on version with panorama roof



Left and right lamps are separately switchable.

Operate rocker switches:

centre = automatic switching on and off.

press I = on.

press 0 = off.

## Rear courtesy lights



Illuminates in conjunction with the front courtesy light depending on rocker switch position.

Press

## Reading lights



Operated with  and  buttons in front and rear courtesy lights.

## Sunvisor lights

Illuminates when the cover is opened.

## Lighting features

### Centre console lighting

Spotlight incorporated in the interior lighting comes on when headlights are switched on.

### Entry lighting

#### Welcome lighting

Following lights are switched on for a short time by unlocking the vehicle with the radio remote control:

- headlights,
- tail lights,
- reversing lights,
- number plate lights,
- instrument panel light,
- interior lights,
- door and console lights,
- puddle lights.

Some functions work only in the dark and facilitates locating the vehicle.

The lighting switches off immediately when the ignition key is turned to position 1 ⇨ 121.

Activation or deactivation of this function can be changed in the menu **Settings** in the Info-Display. Vehicle personalisation ⇨ 93.

The settings can be saved for the key being used ⇨ 21.

The following lights will additionally switch on when the driver's door is opened:

- all switches,
- Driver Information Centre,
- door pocket lights,
- console lights.

## Exit lighting

The following lights switch on if the key is removed from the ignition switch:

- Interior lights
- Instrument panel light (only when it is dark)

- Door and console lights

- Puddle lights

They will switch off automatically after a delay and will be activated again if the driver's door is opened.

Headlights, tail lights, reversing lights and number plate lights illuminate the surrounding area for an adjustable time after leaving the vehicle.

## Switching on



1. Switch off ignition.
2. Remove ignition key.
3. Open driver's door.

4. Pull turn signal lever.

5. Close driver's door.

If the driver's door is not closed the lights switch off after two minutes.

Exit lighting is switched off immediately if the turn signal lever is pulled while the driver's door is open.

Activation, deactivation and duration of this function can be changed in the menu **Settings** in the Info-Display. Vehicle personalisation ⇨ 93.

The settings can be saved for the key being used ⇨ 21.

## Battery discharge protection

### Battery state of charge function

The function guarantees longest battery life via a generator with controllable power output and optimised power distribution.

To prevent discharge of the battery when driving, following systems are reduced automatically in two stages and finally switched off:

- Auxiliary heater
- Heated rear window and mirrors
- Heated seats
- Fan

In the second stage a message which confirms the activation of the battery discharge protection will be displayed in the Driver Information Centre.

### **Switching off electric lights**

To prevent discharge of the battery when the ignition is switched off, some interior lights are switched off automatically after some time.



## Climate control

Climate control systems .....	112
Air vents .....	118
Maintenance .....	119

## Climate control systems

### Heating and ventilation system



Controls for:

- Temperature
- Air distribution
- Fan speed
- Demisting and defrosting

Heated rear window  → 31.



### Temperature

red = warm

blue = cold

Heating will not be fully effective until the engine has reached normal operating temperature.

### Air distribution



-  = to windscreen and front door windows
-  = to head area via adjustable air vents
-  = to foot well

All combinations are possible.

### Fan speed

Adjust the air flow by switching the fan to the desired speed.

### Demisting and defrosting

- Press button : fan automatically switches to higher speed, the air distribution is directed towards the windscreen.
- Set temperature control to warmest level.
- Switch on heated rear window .
- Open side air vents as required and direct them towards the door windows.

## Air conditioning system



In addition to the heating and ventilation system, the air conditioning system has controls for:

-  = cooling
-  = air recirculation

Heated seats  ↗ 39, Heated steering wheel  ↗ 64.

### Cooling

Operated with the  button and is functional only when the engine and fan are running.

The air conditioning system cools and dehumidifies (dries) as soon as the outside temperature is slightly above the freezing point. Therefore condensation may form and drip from under the vehicle.

If no cooling or drying is required, switch the cooling system off to save fuel. When the cooling system is switched off, no engine restart will be requested by the climate control system during an Autostop.

### Air recirculation system

Operated with the  button.



### Warning

The exchange of fresh air is reduced in air recirculation mode. In operation without cooling the air humidity increases, so the windows may mist up from inside. The quality of the passenger compartment air deteriorates, which may cause the vehicle occupants to feel drowsy.

In warm and very humid ambient air conditions, the windscreen might mist up from outside, when cold air is directed to it. If windscreen mists up from outside, activate windscreen wiper and deactivate .



### Maximum cooling

Briefly open the windows so that hot air can disperse quickly.

- Cooling  on.
- Air circulation system  on.
- Press air distribution switch .
- Set temperature control to coldest level.
- Set fan speed to highest level.
- Open all vents.

## Demisting and defrosting the windows



- Press button : fan automatically switches to higher speed, the air distribution is directed towards the windscreen.
- Switch cooling  on.
- Set temperature control to warmest level.
- Switch on heated rear window .
- Open side air vents as required and direct them towards the door windows.

### Note

If the settings for demisting and defrosting are selected, an Autostop will be inhibited.

If the settings for demisting and defrosting are selected while the engine is in an Autostop, the engine will restart automatically.



## Electronic climate control system

The dual zone climate control allows different climatisation temperatures for driver and front passenger side.



Controls for:

- Temperature on driver side
- Air distribution
- Fan speed
- Temperature on front passenger side

-  = cooling
- AUTO** = automatic mode
-  = manual air recirculation
-  = demisting and defrosting

Heated rear window  ⇨ 31, Heated seats  ⇨ 39, Heated steering wheel  ⇨ 64.

The preselected temperature is automatically regulated. In the automatic mode, the fan speed and air distribution automatically regulate the air flow.

The system can be manually adapted via the use of air distribution and air flow controls.

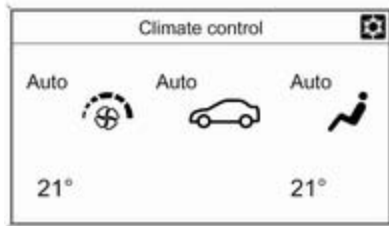

Each change of settings is shown in the Info-Display for a few seconds.

The electronic climate control system is only fully operational when the engine is running.

## Automatic mode AUTO



Basic setting for maximum comfort:

- Press **AUTO** button: the air distribution and fan speed are regulated automatically.
- Open all air vents.
- Press  to switch on cooling. On some versions cooling is activated automatically by pressing the **AUTO** button.
- Set the preselected temperatures for driver and front passenger using the left and right rotary knobs to 22 °C.

The fan speed regulation in automatic mode can be changed in the menu **Settings**.

Vehicle personalisation ⇨ 93.

All air vents are actuated automatically in automatic mode. The air vents should therefore always be open.

## Temperature preselection

Temperatures can be set to the desired value.



If the minimum temperature is set, the climate control system runs at maximum cooling.





If the maximum temperature is set, the climate control system runs at maximum heating.

**Note**



If the temperature is reduced 2 °C or more while the engine is in an Autostop, the engine will restart automatically.

Stop-start system ⇨ 123.

**Demisting and defrosting the windows** 

- Press button .
- Press cooling button .
- Temperature and air distribution are set automatically and the fan runs at high speed.
- Switch on heated rear window .
- To return to automatic mode: press button  or **AUTO**.

**Note**

If the  button is pressed while the engine is running, an Autostop will be inhibited until the  button is pressed again.

If the  button is pressed while the engine is in an Autostop, the engine will restart automatically.

**Manual settings**

Climate control system settings can be changed by activating the buttons and rotary knobs as follows.

Changing a setting will deactivate the automatic mode.

**Fan speed** 



Press lower button to decrease or upper button to increase fan speed as shown in the illustration. The fan speed is indicated by the number of segments in the display.

Press and hold the lower button: fan and cooling are switched off.

Press and hold upper button: the fan runs at maximum speed.

To return to automatic mode: Press **AUTO** button.

**Air distribution** , , 

Press appropriate button for desired adjustment. Activation is indicated by the LED in the button.

 = to windscreen and front door windows.

 = to head area via adjustable air vents.

 = to foot well.

All combinations are possible.

Return to automatic air distribution: Deactivate corresponding setting or press button **AUTO**.

## Cooling ☀

Activate or deactivate with the ☀ button.

The air conditioning system cools and dehumidifies (dries) when outside temperature is above a specific level. Therefore condensation may form and drip from under the vehicle.

If no cooling or drying is required, switch the cooling system off to save fuel. When the cooling system is switched off, no engine restart will be requested by the climate control system during an Autostop.

The display will indicate **ACON** when cooling is activated or **ACOFF** when the cooling is deactivated.

## Air recirculation mode 🚗

### ⚠ Warning

The exchange of fresh air is reduced in air recirculation mode. In operation without cooling the air humidity increases, so the windows may mist up from inside. The quality of the passenger compartment air deteriorates, which may cause the vehicle occupants to feel drowsy.

In warm and very humid ambient air conditions, the windscreen might mist up from outside, when cold air is directed to it. If windscreen mists up from outside, activate windscreen wiper and deactivate 🚗.



Press button 🚗 once to activate the manual air recirculation mode.

Activation is indicated by the LED in the button.

## Basic settings

Some settings can be changed in the menu **Settings** in the Info-Display. Vehicle personalisation ⇨ 93.

## Auxiliary heater

### Air heater

Quickheat is an electric auxiliary air heater which automatically warms up the passenger compartment more quickly.

## Air vents

### Adjustable air vents

At least one air vent must be open while the cooling is on.



To open the vent, turn the adjuster wheel towards the bigger ■ symbol. Adjust the air amount at the vent outlet by turning the adjuster wheel.



Direct the flow of air by tilting and swivelling the slats.

To close the vent, turn the adjuster wheel towards the smaller ■ symbol.

### **⚠ Warning**

Do not attach any objects to the slats of the air vents. Risk of damage and injury in case of an accident.

### Fixed air vents

Additional air vents are located beneath the windscreen and door windows and in the foot wells.

## Maintenance

### Air intake

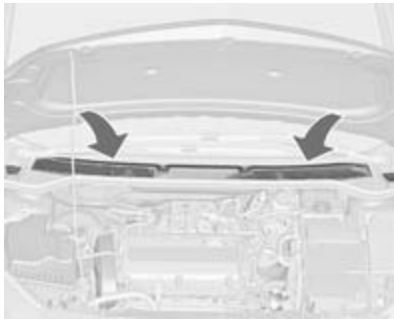

The air intake in front of the windscreen in the engine compartment must be kept clear to allow air intake. Remove any leaves, dirt or snow.

### Pollen filter

The pollen filter cleans dust, soot, pollen and spores from the air entering the vehicle through the air intake.

### Air conditioning regular operation

In order to ensure continuously efficient performance, cooling must be operated for a few minutes once a month, irrespective of the weather and time of year. Operation with cooling is not possible when the outside temperature is too low.

### Service

For optimal cooling performance, it is recommended to annually check the climate control system, starting three years after initial vehicle registration, including:

- Functionality and pressure test
- Heating functionality
- Leakage check
- Check of drive belts
- Cleaning of condenser and evaporator drainage
- Performance check



## Driving and operating

Driving hints .....	120
Starting and operating .....	121
Engine exhaust .....	125
Automatic transmission .....	127
Manual transmission .....	130
Brakes .....	131
Ride control systems .....	134
Driver assistance systems .....	138
Fuel .....	147
Towing .....	150

## Driving hints

### Control of the vehicle

#### **Never coast with engine not running (except during Autostop)**

Many systems will not function in this situation (e.g. brake servo unit, power steering). Driving in this manner is a danger to yourself and others. All systems function during an Autostop, but there will be a controlled reduction in power steering assist and vehicle speed is reduced.

Stop-start system ⇨ 123.

#### **Idle boost**

If charging of the battery is required due to battery condition, the power output of the generator has to be increased. This will be achieved by an idle boost which may be audible.

On vehicles with Uplevel-Display or Uplevel-Combi-Display, a message appears in the Driver Information Centre.

## Pedals

To ensure the pedal travel is uninhibited, there must be no mats in the area of the pedals.

## Starting and operating

### New vehicle running-in

Do not brake unnecessarily hard for the first few journeys.

During the first drive, smoke may occur because of wax and oil evaporating off the exhaust system. Park the vehicle in the open for a while after the first drive and avoid inhaling the fumes.

During the running-in period fuel and engine oil consumption may be higher and the cleaning process of the diesel particle filter may take place more often. Autostop may be inhibited to allow for charging the battery.

Diesel particle filter ⇨ 125.

### Ignition switch positions

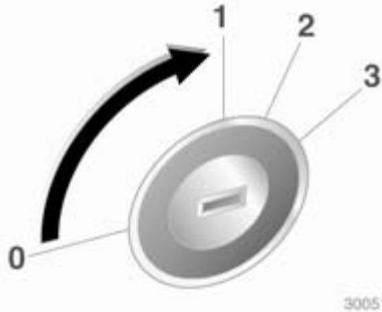

- 0 = Ignition off
- 1 = Steering wheel lock released, ignition off
- 2 = Ignition on, for diesel engine: preheating
- 3 = Starting

### Retained power off

The following electronic systems can work until the driver's door is opened or at the latest for 10 minutes after the ignition is switched off:

- Power windows
- Power outlets

Power to the Infotainment system will continue to operate for 30 minutes or until the key is removed from the ignition switch, regardless of whether any door will be opened.

### Starting the engine

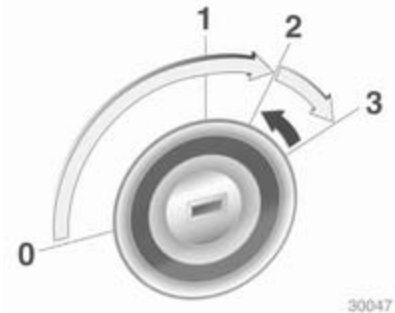

Manual transmission: operate clutch.  
Automatic transmission: operate brake and move the selector lever to **P** or **N**.

Do not operate the accelerator pedal.

Diesel engine: turn the key to position **2** for preheating until control indicator  extinguishes.

Turn the key briefly to position **3** and release: an automatic procedure operates the starter with a short delay as long as the engine is running, see Automatic Starter Control.

Before restarting or to switch off the engine, turn the key back to position **0**.

During an Autostop, the engine can be started by depressing the clutch pedal.

### Starting the vehicle at low temperatures

The start of the engine without additional heaters is possible down to  $-25\text{ }^{\circ}\text{C}$  for diesel engines and  $-30\text{ }^{\circ}\text{C}$  for petrol engines. Required is an engine oil with the correct viscosity, the correct fuel, performed services and a sufficiently charged battery. With temperatures below  $-30\text{ }^{\circ}\text{C}$  the automatic transmission need a warming phase of approx. 5 minutes. The selector lever must be in position **P**.

### Automatic Starter Control

This function controls the engine starting procedure. The driver does not have to hold the key in position **3**. Once applied, the system will go on starting automatically until the engine is running. Because of the checking procedure, the engine starts running after a short delay.

Possible reasons for a non-starting engine:

- Clutch pedal not operated (manual transmission)
- Brake pedal not operated or selector lever not in **P** or **N** (automatic transmission)
- Timeout occurred

### Turbo engine warm-up

Upon start-up, engine available torque may be limited for a short time, especially when the engine temperature is cold. The limitation is to allow the lubrication system to fully protect the engine.

### Overrun cut-off

The fuel supply is automatically cut off during overrun, i.e. when the vehicle is driven with a gear engaged but accelerator is released.

## Stop-start system

The stop-start system helps to save fuel and to reduce the exhaust emissions. When conditions allow, it switches off the engine as soon as the vehicle is at a low speed or at a standstill, e.g. at a traffic light or in a traffic jam. It starts the engine automatically as soon as the clutch is depressed. A battery sensor ensures that an Autostop is only performed if the battery is sufficiently charged for a restart.

### Activation

The stop-start system is available as soon as the engine is started, the vehicle starts-off and the conditions as stated below in this section are fulfilled.

### Deactivation



Deactivate the stop-start system manually by pressing the **eco** button. The deactivation is indicated when the LED in the button extinguishes.

### Autostop

If the vehicle is at a low speed or at a standstill, activate an Autostop as follows:

- Depress the clutch pedal
- set the lever in neutral
- release the clutch pedal

The engine will be switched off while the ignition stays on.



An Autostop is indicated by the needle at the **AUTOSTOP** position in the tachometer.

During an Autostop, the heating and brake performance will be maintained.

### Caution

The steering assist can be reduced during an Autostop.

**Conditions for an Autostop**

The stop-start system checks if each of the following conditions is fulfilled. Otherwise an Autostop will be inhibited.

- The stop-start system is not manually deactivated
- the bonnet is fully closed
- the driver's door is closed or the driver's seat belt is fastened
- the battery is sufficiently charged and in good condition
- the engine is warmed up
- the engine coolant temperature is not too high
- the engine exhaust temperature is not too high, e.g. after driving with high engine load
- the ambient temperature is not too low
- the climate control system does not inhibit an Autostop
- the brake vacuum is sufficient

- the self-cleaning function of the diesel particle filter is not active
- the vehicle has moved since the last Autostop

Ambient temperature near to the freezing point can inhibit an Autostop. Certain settings of the climate control system may inhibit an Autostop. See Climate control chapter for more details.

Immediately after motorway driving an Autostop may be inhibited.

New vehicle running-in ⇨ 121.

**Battery discharge protection**

To ensure reliable engine restarts, several battery discharge protection features are implemented as part of the stop-start system.

**Power saving measures**

During an Autostop, several electrical features such as auxiliary electric heater or rear window heating are disabled or switched into a power saving mode. The fan speed of the climate control system is reduced to save power.

**Restart of the engine by the driver**

Depress the clutch pedal to restart the engine.

The engine start is indicated by the needle at the idle speed position in the tachometer.

If the selector lever is shifted out of neutral before depressing the clutch first, control indicator  illuminates or is shown as a symbol in the Driver Information Centre.

Control indicator  ⇨ 76.

**Restart of the engine by the stop-start system**

The selector lever has to be in neutral to enable an automatic restart.

If one of the following conditions occurs during an Autostop, the engine will be restarted automatically by the stop-start system.

- The stop-start system is manually deactivated
- the bonnet is opened

- the driver's seat belt is unfastened and the driver's door is opened
- the engine temperature is too low
- the battery is discharged
- the brake vacuum is not sufficient
- the vehicle starts to move
- the climate control system requests an engine start
- the air conditioning is manually switched on

If the bonnet is not fully closed, a warning message is displayed in the Driver Information Centre.

If an electrical accessory, e.g. a portable CD player, is connected to the power outlet, a brief power drop during restart might be noticeable.

## Parking

- Do not park the vehicle on an easily ignitable surface. The high temperature of the exhaust system could ignite the surface.
- Always apply parking brake. Apply manual parking brake without pressing release button. Apply as

firmly as possible on downhill or uphill slopes. Depress the foot brake at the same time to reduce operating force.

- Switch off the engine and ignition. Turn the steering wheel until the steering wheel lock engages.
- If the vehicle is on a level surface or uphill slope, engage first gear or set the selector lever to **P** before switching off the ignition. On an uphill slope, turn the front wheels away from the kerb.

If the vehicle is on a downhill slope, engage reverse gear or set the selector lever to **P** before switching off the ignition. Turn the front wheels towards the kerb.

- Lock the vehicle and activate the anti-theft alarm system.

### Note

In the event of an accident with airbag deployment, the engine is turned off automatically if the vehicle comes to a standstill within a certain time.

## Engine exhaust

### Danger

Engine exhaust gases contain poisonous carbon monoxide, which is colourless and odourless and could be fatal if inhaled.

If exhaust gases enter the interior of the vehicle, open the windows. Have the cause of the fault rectified by a workshop.

Avoid driving with an open load compartment, otherwise exhaust gases could enter the vehicle.

## Diesel particle filter

The diesel particle filter system filters harmful soot particles out of the exhaust gases. The system includes a self-cleaning function that runs automatically during driving without any notification. The filter is cleaned by periodically burning off the soot particles at high temperature. This process takes place automatically under set driving conditions and may

take up to 25 minutes. Typically it needs between 7 and 12 minutes. Autostop is not available and fuel consumption may be higher during this period. The emission of smells and smoke during this process is normal.



Under certain driving conditions, e.g. short distances, the system cannot clean itself automatically.

If the cleaning of the filter is required and if previous driving conditions did not enable automatic cleaning, it will be indicated by control indicator . Simultaneously **Diesel partic. filter is**

**full continue driving** or warning code 55 appears in the Driver Information Centre.

 illuminates when diesel particle filter is full. Start cleaning process as soon as possible.

 flashes when diesel particle filter has reached the maximum filling level. Start cleaning process immediately to avoid damage to the engine.

### Cleaning process

To activate cleaning process, continue driving, keep engine speed above 2000 revolutions per minute. Shift down if necessary. Diesel particle filter cleaning is then started.

If  illuminates additionally, cleaning is not possible, seek the assistance of a workshop.

### Caution

If the cleaning process is interrupted, there is a risk of provoking severe engine damage.

Cleaning takes place quickest at high engine speeds and loads.

The control indicator  extinguishes as soon as the self-cleaning operation is complete.

## Catalytic converter

The catalytic converter reduces the amount of harmful substances in the exhaust gases.

### Caution

Fuel grades other than those listed on pages ⇨ 147, ⇨ 205 could damage the catalytic converter or electronic components.

Unburnt petrol will overheat and damage the catalytic converter. Therefore avoid excessive use of the starter, running the fuel tank dry and starting the engine by pushing or towing.

In the event of misfiring, uneven engine running, a reduction in engine performance or other unusual problems, have the cause of the fault

rectified by a workshop as soon as possible. In an emergency, driving can be continued for a short period, keeping vehicle speed and engine speed low.

## Automatic transmission

The automatic transmission permits automatic gearshifting (automatic mode) or manual gearshifting (manual mode).

## Transmission display

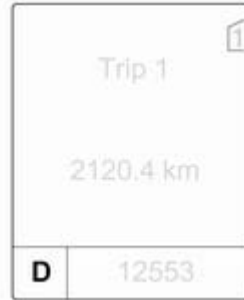

The mode or selected gear is shown in the transmission display.

## Selector lever





- P** = park position, wheels are locked, engage only when the vehicle is stationary and the parking brake is applied
- R** = reverse gear, engage only when the vehicle is stationary
- N** = neutral
- D** = automatic mode with all gears

The selector lever is locked in **P** and can only be moved when the ignition is on and the brake pedal is applied.





Without brake pedal applied, the control indicator  illuminates.

If the selector lever is not in **P** when the ignition is switched off, the control indicators  and **P** flash.

To engage **P** or **R**, press the release button.

The engine can only be started with the lever in position **P** or **N**. When position **N** is selected, press the brake pedal or apply the parking brake before starting.

Do not accelerate while engaging a gear. Never depress the accelerator pedal and brake pedal at the same time.

When a gear is engaged, the vehicle slowly begins to creep when the brake is released.

### Engine braking

To utilise the engine braking effect, select a lower gear in good time when driving downhill, see manual mode.

### Rocking the vehicle

Rocking the vehicle is only permissible if the vehicle is stuck in sand, mud or snow. Move the selector lever between **D** and **R** in a repeat pattern. Do not race the engine and avoid sudden acceleration.

### Parking

Apply the parking brake and engage **P**.

The ignition key can only be removed when the selector lever is in position **P**.

## Manual mode



Move selector lever out of position **D** towards the left and then forwards or backwards.

**+** = Shift to a higher gear.

**-** = Shift to a lower gear.

If a higher gear is selected when vehicle speed is too low, or a lower gear when vehicle speed is too high, the shift is not executed. This can cause a message in the Driver-Info-Display.

In manual mode no automatic shifting to a higher gear takes place at high engine revolutions.

## Electronic driving programmes

- Following a cold start, the operating temperature programme increases engine speed to quickly bring the catalytic converter to the required temperature.
- The automatic neutral shift function automatically shifts to idling when the vehicle is stopped with a forward gear engaged and the brake pedal is pressed.
- When SPORT mode is engaged, the vehicle shifts at higher engine speeds (unless cruise control is on). SPORT mode ↻ 135.
- Special programmes automatically adapt the shifting points when driving up inclines or down hills.

## Kickdown

If the accelerator pedal is pressed down completely in automatic mode, the transmission shifts to a lower gear depending on engine speed.

## Fault

In the event of a fault,  illuminates. Additionally a code number or a vehicle message is displayed in the Driver Information Centre. Vehicle messages ↻ 86.

The transmission no longer shifts automatically. Continued travel is possible with manual shifting.

Only the highest gear is available. Depending on the fault, 2nd gear may also be available in manual mode. Shift only when vehicle is at a standstill.

Have the cause of the fault remedied by a workshop.

## Interruption of power supply

In the event of an interruption of power supply, the selector lever cannot be moved out of the **P** position. The ignition key cannot be removed from the ignition switch.

If the battery is discharged, start the vehicle using jump leads ↻ 190.

If the battery is not the cause of the fault, release the selector lever.

1. Apply the parking brake.



2. Release the selector lever trim from the centre console at the front, fold it upwards and rotate it to the left.

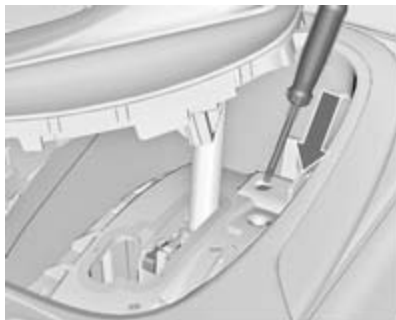

3. Insert a screwdriver into the opening as far as it will go and move the selector lever out of **P** or **N**. If **P** or **N** is engaged again, the selector lever will be locked in position again. Have the cause of the power supply interruption remedied by a workshop.
4. Mount the selector lever trim onto the centre console and refit.

## Manual transmission



To engage reverse, with the vehicle stationary wait 3 seconds after depressing the clutch pedal and then press the release button on the selector lever and engage the gear.

If the gear does not engage, set the lever to neutral, release the clutch pedal and depress again; then repeat gear selection.

Do not grind the clutch unnecessarily.

When operating, depress the clutch pedal completely. Do not use the pedal as a foot rest.

### Caution

It is not advisable to drive with the hand resting on the selector lever.

## Brakes

The brake system comprises two independent brake circuits.

If a brake circuit fails, the vehicle can still be braked using the other brake circuit. However, braking effect is achieved only when the brake pedal is depressed firmly. Considerably more force is needed for this. The braking distance is extended. Seek the assistance of a workshop before continuing your journey.

When the engine is not running, the support of the brake servo unit disappears once the brake pedal has been depressed once or twice. Braking effect is not reduced, but braking requires significantly greater force. It is especially important to bear this in mind when being towed.

Control indicator  ↪ 76.

## Antilock brake system

Antilock brake system (ABS) prevents the wheels from locking.

ABS starts to regulate brake pressure as soon as a wheel shows a tendency to lock. The vehicle remains steerable, even during hard braking.

ABS control is made apparent through a pulse in the brake pedal and the noise of the regulation process.

For optimum braking, keep the brake pedal fully depressed throughout the braking process, despite the fact that the pedal is pulsating. Do not reduce the pressure on the pedal.

After starting off the system performs a self-test which may be audible.

Control indicator  ↪ 77.

## Adaptive brake light

During full braking, all three brake lights flash for the duration of ABS control.

## Fault

### Warning

If there is a fault in the ABS, the wheels may be liable to lock due to braking that is heavier than normal. The advantages of ABS are no longer available. During hard braking, the vehicle can no longer be steered and may swerve.

Have the cause of the fault remedied by a workshop.

## Parking brake

### Manual parking brake

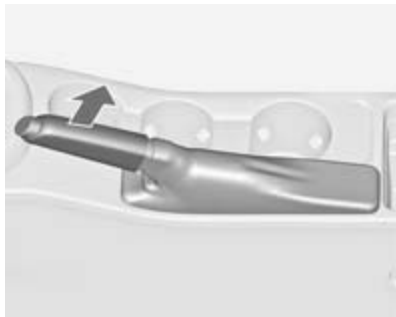

Always apply parking brake firmly without operating the release button, and apply as firmly as possible on a downhill or uphill slope.

To release the parking brake, pull the lever up slightly, press the release button and fully lower the lever.



To reduce the operating forces of the parking brake, depress the foot brake at the same time.

Control indicator  ↗ 76.

### Electrical parking brake



#### Applying when vehicle is stationary

Pull switch , the electrical parking brake operates automatically with an adequate force. For maximum force, e.g. parking with trailer or on inclines, pull switch  twice.

The electrical parking brake is applied when control indicator  lights up ↗ 77.

The electrical parking brake can always be activated, even if the ignition is off.

Do not operate electrical parking brake system too often without engine running because this will discharge the battery.

Before leaving the vehicle, check the electrical parking brake status. Control indicator  ↗ 77.

#### Releasing

Switch on ignition. Keep brake pedal depressed and then push switch .

#### Drive away function

Depressing clutch pedal (manual transmission) or engaging drive gear (automatic transmission) and then depressing the accelerator pedal releases the electrical parking brake automatically. This is not possible when the switch is pulled at the same time.

This function also helps driving away on inclines.

Aggressive drive away may reduce life time of wear parts.

### **Dynamic braking when vehicle is moving**

When the vehicle is moving and the switch (P) is kept pulled, the electrical parking brake system will decelerate the vehicle, but will not apply statically.

As soon as the switch (P) is released, dynamic braking will be stopped.

### **Fault**

Failure mode of electrical parking brake is indicated by control indicator (P) and by a code number or a vehicle message which is displayed in the Driver Information Centre. Vehicle messages ⇨ 86.

Apply electrical parking brake: pull and hold the switch (P) for more than 5 seconds. If control indicator (P) illuminates, electrical parking brake is applied.

Release electrical parking brake: push and hold the switch (P) for more than 2 seconds. If control indicator (P) extinguishes, electrical parking brake is released.

Control indicator (P) flashes: electrical parking brake is not fully applied or released. When continuously flashing, release electrical parking brake and retry applying.

### **Brake assist**

If the brake pedal is depressed quickly and forcefully, maximum brake force is automatically applied (full braking).

Maintain steady pressure on the brake pedal for as long as full braking is required. Maximum brake force is automatically reduced when the brake pedal is released.

### **Hill start assist**

The system helps prevent unintended movement when driving away on inclines.

When releasing the foot brake after stopping on an incline, the brakes remain on for a further two seconds. The brakes release automatically as soon as the vehicle begins to accelerate.

The hill start assist is not active during an Autostop.

## Ride control systems

### Traction Control system

The Traction Control system (TC) is a component of the Electronic Stability Control.

TC improves driving stability when necessary, regardless of the type of road surface or tyre grip, by preventing the drive wheels from spinning.

As soon as the drive wheels starts to spin, engine output is reduced and the wheel spinning the most is braked individually. This considerably improves the driving stability of the vehicle on slippery road surfaces.

TC is operational as soon as the control indicator  extinguishes.

When TC is active  flashes.

### Warning

Do not let this special safety feature tempt you into taking risks when driving.

Adapt speed to the road conditions.

Control indicator  ⇨ 78.

### Deactivation



TC can be switched off when spinning of drive wheels is required: press button  briefly.

Control indicator  illuminates.

TC is reactivated by pressing the  button again.

TC is also reactivated the next time the ignition is switched on.

### Electronic Stability Control

Electronic Stability Control (ESC) improves driving stability when necessary, regardless of the type of road surface or tyre grip. It also prevents the drive wheels from spinning.

As soon as the vehicle starts to swerve (understeer/oversteer), engine output is reduced and the wheels are braked individually. This considerably improves the driving stability of the vehicle on slippery road surfaces.

ESC is operational as soon as the control indicator  extinguishes.

When ESC is active  flashes.

### Warning

Do not let this special safety feature tempt you into taking risks when driving.

Adapt speed to the road conditions.

Control indicator   78.

### Deactivation



For very high-performance driving ESC can be deactivated: hold button  depressed for approx. 7 seconds.

Control indicator  illuminates.

ESC is reactivated by pressing the  button again. If the TC system was previously disabled, both TC and ESC are reactivated.

ESC is also reactivated the next time the ignition is switched on.

## Interactive driving system

### Flex Ride

Flex Ride driving system allows the driver to select between three driving modes:

- SPORT mode: press button **SPORT**, LED illuminates.
- TOUR mode: press button **TOUR**, LED illuminates.
- Normal mode: both buttons **SPORT** and **TOUR** are not pressed, no LED illuminates.

Deactivate SPORT mode and TOUR mode by pressing corresponding button once more.

In each driving mode Flex Ride networks the following electronic systems:

- Continuous Damping Control.
- Accelerator Pedal Control.
- Steering Control.
- Electronic Stability Control (ESC).
- Antilock brake system (ABS) with cornering brake control (CBC).
- Automatic transmission.





**SPORT mode**

The settings of the systems are adapted to a sportier driving style:

- Damping of shock absorbers reacts more stiffly to provide better contact with the road surface.
- The engine reacts more quickly to the accelerator pedal.
- Steering support is reduced.
- Shift points of automatic transmission occur later.
- With SPORT mode activated, the illumination of main instruments changes from white to red.

**TOUR mode**

The settings of the systems are adapted to a comfort driving style:

- Damping of shock absorbers reacts more softly.
- Accelerator pedal reacts with standard settings.
- Steering support is in standard mode.

- Shift points of automatic transmission occur in a comfort mode.
- Illumination of main instruments is white.

**Normal mode**

All settings of the systems are adapted to standard values.

**Drive mode control**

Within each manually selected driving mode (SPORT, TOUR or Normal), the Drive Mode Control (DMC) detects and analyses continuously the real driving characteristic, responses by the driver, and the active dynamic state of the vehicle. If necessary, the control unit of DMC automatically changes the settings within the selected driving mode or, when recognising greater variations, the driving mode is changed for the length of variation.

If, for example, **Normal** mode is selected and DMC detects a sporty driving behaviour, DMC changes several settings of the Normal mode

into sporty settings. The DMC changes to SPORT mode in case of very sporty driving behaviour.

If, for another example, TOUR mode is selected and whilst driving on a winding road a sudden hard brake is necessary, DMC will detect the dynamic vehicle condition and changes the settings for suspension to SPORT mode, to increase vehicle stability.

When the driving characteristic or the dynamic vehicle state returns to the former state, DMC will change the settings to the preselected driving mode.

**Personalised settings in the SPORT mode**

The driver can select the functions of the SPORT mode when **SPORT** button is pressed. These settings can be changed in the menu **Settings** in the Info-Display. Vehicle personalisation ⇨ 93.

## Flex Ride - VXR Version

The VXR Version of Flex Ride system works in the same way as the standard Flex Ride system with the difference that the modes have a more sporty characteristic.



VXR Flex Ride driving system allows the driver to select between three driving modes:

- **VXR mode:** press button **VXR**, LED illuminates.
- **SPORT mode:** press button **SPORT**, LED illuminates.
- **NORMAL mode:** neither button **SPORT** nor **VXR** is pressed, no LED illuminates.

Deactivate SPORT mode and VXR mode by pressing corresponding button once more.

In each driving mode VXR Flex Ride networks the following electronic systems:

- Continuous Damping Control.
- Accelerator Pedal Control.
- Steering Control.
- Electronic Stability Control (ESC).
- Antilock brake system (ABS) with cornering brake control (CBC).

## NORMAL mode

In NORMAL mode, when neither SPORT nor VXR button is pressed, all settings of the systems are adapted to standard values.

## SPORT mode

The settings of the systems are adapted to a sportier driving style.

## VXR mode

The drive dynamic characteristics are adapted to high performance settings.

In this mode the illumination of main instruments is switched to red.

## Personalised settings in the VXR mode

The driver can select the functions of the VXR mode when **VXR** button is pressed. These settings can be changed in the menu **Settings** in the Info-Display. Vehicle personalisation  
⇨ 93.

## Driver assistance systems

### ⚠ Warning

Driver assistance systems are developed to support the driver and not to replace his attention.

The driver accepts fully responsibility when driving the vehicle.

When using driver assistance systems, always take care regarding the current traffic situation.

## Cruise control

The cruise control can store and maintain speeds of approx. 20 to 120 mph. Deviations from the stored speeds may occur when driving uphill or downhill.

For safety reasons the cruise control cannot be activated until the foot brake has been operated once. Activating in first gear is not possible.





Do not use the cruise control if it is not advisable to maintain a constant speed.

With automatic transmission, only activate cruise control in automatic mode.

Control indicator   $\rightarrow$  80.

### Switching on

Press button , control indicator  in instrument cluster illuminates white.

### Activation

Accelerate to the desired speed and turn thumb wheel to **SET/-**, the current speed is stored and

maintained. Control indicator  in instrument cluster illuminates green. Accelerator pedal can be released.

Vehicle speed can be increased by depressing the accelerator pedal. When the accelerator pedal is released, the previously stored speed is resumed.

Cruise control remains activated while gear is changed.

### Increase speed



With cruise control active, hold thumb wheel turned to **RES/+** or briefly turn to **RES/+** repeatedly: speed increases continuously or in small increments.

Alternatively accelerate to the desired speed and store by turning to **SET/-**.

### Reduce speed

With cruise control active, hold thumb wheel turned to **SET/-** or briefly turn to **SET/-** repeatedly: speed decreases continuously or in small increments.

## Deactivation

Press button , control indicator  in instrument cluster illuminates white. Cruise control is deactivated. Last used set speed is stored in memory for later speed resume.



Automatic deactivation:

- vehicle speed below approx. 20 mph,
- vehicle speed above approx. 125 mph,
- the brake pedal is depressed,
- the clutch pedal is depressed for a few seconds,
- selector lever in **N**,
- engine speed in a very low range,
- the Traction Control system or Electronic Stability Control is operating.

## Resume stored speed

Turn thumb wheel to **RES/+** at a speed above 20 mph. The stored speed will be obtained.

## Switching off

Press button , control indicator  in instrument cluster extinguishes. The stored speed is deleted.

Pressing button  for activating speed limiter or switching off the ignition also switches off cruise control and deletes the stored speed.

## Speed limiter

The speed limiter prevents the vehicle exceeding a preset maximum speed.



The maximum speed can be set at a speed above 15 mph.

The driver can only accelerate up to the preset speed. Deviations from the limited speed may occur when driving downhill.

The preset speed limit is displayed in the top line of the Driver Information Centre when the system is active.

## Activation



Press button . If cruise control or adaptive cruise control has been activated before, it is switched off when speed limiter is activated and the control indicator  extinguishes.

## Set speed limit

With speed limiter active, hold thumb wheel turned to **RES/+** or briefly turn to **RES/+** repeatedly until the desired maximum speed is displayed in the Driver Information Centre.

Alternatively accelerate to the desired speed and briefly turn thumb wheel to **SET/-**: the current speed is stored as

maximum speed. Speed limit is displayed in the Driver Information Centre.



### Change speed limit

With speed limiter active, turn thumb wheel to **RES/+** to increase or **SET/-** to decrease the desired maximum speed.

### Exceeding the speed limit

In the event of an emergency it is possible to exceed the speed limit by depressing the accelerator pedal firmly beyond the point of resistance.

The limited speed will flash in the Driver Information Centre and a chime sounds during this period. Release the accelerator pedal and the speed limiter function is reactivated once a speed lower than the limit speed is obtained.

### Deactivation

Press button : speed limiter is deactivated and the vehicle can be driven without speed limit.

The limited speed is stored and a corresponding message appears in the Driver Information Centre.

### Resume limit speed

Turn thumb wheel to **RES/+**. The stored speed limit will be obtained.



### Switching off

Press button , the speed limit indication in the Driver Information Centre extinguishes. The stored speed is deleted.

By pressing button  to activate cruise control or adaptive cruise control or by switching off the ignition, speed limiter is also deactivated and the stored speed is deleted.

## Following distance indication

The following distance indication displays the distance to a preceding moving vehicle. The front camera in the windscreen is used to detect the distance of a vehicle directly ahead in the vehicle's path. It is active at speeds above 25 mph.

When a preceding vehicle is detected ahead, the distance is indicated in seconds, displayed on a page in the Driver Information Centre  81. Press the **MENU** button on the turn signal lever to select **Vehicle Information Menu**  and turn the adjuster wheel to choose following distance indication page.



The minimum indicated distance is 0.5 seconds.

If there is no vehicle ahead or the vehicle ahead is out of range, two dashes will be displayed: -- s.

## Parking assist



The parking assist makes parking easier by measuring the distance between the vehicle and obstacles, and giving acoustic signals.

The warning chime regarding unfastened seat belts has priority over any other acoustic signal ↻ 89.

Even when using the parking assist, the driver remains fully responsible for the parking manoeuvre.

The system consists of four ultrasonic parking sensors in the rear bumper. If the vehicle is equipped with a front

parking assist the system consists of four additional ultrasonic parking sensors in the front bumper.

The system uses two different frequencies for the front and rear sensors, respectively, each with a different sound.

Control indicator P ↻ 78.

### Activation



When reverse gear is engaged, the system is activated automatically.

The front parking assist can also be activated at a low speed by pressing the P button.

An illuminated LED in the parking assist button indicates that the system is ready to operate.

Depending on which of the sensors are closer to an obstacle, you will hear the buzzing sound of the respective sensors. The interval between the sounds becomes shorter as the vehicle gets closer to the obstacle. When the distance is less than 30 cm, the buzzing is continuous.



Depending on the version, the distance to a front obstacle is indicated in the Driver Information Centre by changing segments.

If the **P** button is pressed once within an ignition cycle, the front parking assist is always reactivated when the vehicle speed goes below a certain value.

### Deactivation

Deactivate the system by pressing the **P** button.

The LED in the button extinguishes and **Park Assist Off** will be displayed in the Driver Information Centre.

The system is deactivated automatically when exceeding a certain speed.

### Fault

In the event of a fault in the system, **P** illuminates or a vehicle message is displayed in the Driver Information Centre.

Additionally, **P** illuminates or a vehicle message is displayed in the Driver Information Centre if a malfunction of the system due to temporary conditions like snow covered sensors is detected.

Vehicle messages ↪ 86.

## Important hints for using the parking assist

### Warning

Under certain circumstances, various reflective surfaces on objects or clothing as well as external noise sources may cause the system to fail to detect obstacles.

Special attention has to be paid to low obstacles which can damage the lower part of the bumper.

### Caution

Performance of the sensor can be reduced when sensors are covered, e.g. by ice or snow.

Performance of the parking assist system can be reduced due to heavy loading.

Special conditions apply if there are taller vehicles involved (e.g. off-road vehicles, mini vans, vans). Object identification in the upper part of these vehicles cannot be guaranteed.

Objects with a very small reflection cross section, like objects of narrow size or soft materials, may not be detected by the system.

Parking assist will not detect objects out of the detection range.

#### Note

The parking assist system automatically detects factory-fitted towing equipment. It is deactivated when the connector is plugged in.

The sensor may detect a non-existing object (echo disturbance) caused by external acoustical or mechanic disturbances.

## Traffic sign assistant

### Functionality

The traffic sign assistant system detects designated traffic signs via a front camera and displays them in the Driver Information Centre.



Traffic signs, which will be detected, are:

#### Limit- and no passing signs

- speed limit
- no passing
- end of speed limit
- end of no passing

### Road signs

- beginning of motorway
- end of motorway
- A-roads
- playstreets

### Add on signs

- additional hints to traffic signs
- wet warning
- ice warning
- direction arrows

Speed limit signs are displayed in the Driver Information Centre until the next speed limit sign or end of speed limit is detected or rather sign timeout and after a defined time.





Combinations of more signs in the display are possible.



An exclamation mark in a frame indicates that there is an add on sign detected which cannot be recognised by the system.

The system is active up to a speed of 124 mph depending on the lighting conditions. At night the system is active up to a speed of 99 mph.

As soon as the speed becomes slower than 34 mph the display will be reset and the content of the traffic sign page will be cleared. The next recognised speed indication will be displayed.

### Display indication



Traffic signs are displayed on the page **Traffic sign detection** in the **Trip/Fuel Information Menu**, chosen via the adjuster wheel on the turn signal lever ↻ 81.

When another function on the Driver Information Centre menu was selected and then **Traffic sign detection** page is chosen again, the last recognised traffic sign will be displayed.

If the system is deactivated by itself, the content of the traffic sign page is cleared, indicated by the following symbol:



The content of the traffic sign page is also cleared during driving by pushing the **SET/CLR** button on the turn signal lever for a longer time.



### Pop-up function

Speed limits and no passing signs are displayed as pop-ups on each page of the menu.

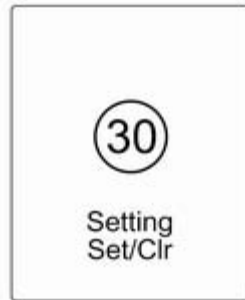

The pop-up function can be deactivated on the traffic sign page by pressing the **SET/CLR** button on the turn signal lever.

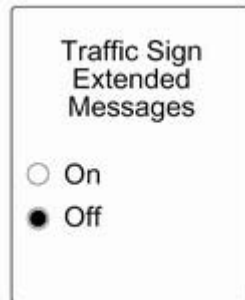

Once setting page is displayed, select **Off** to deactivate pop-up function. Reactivated by selecting **On**. When switching on the ignition, pop-up function is deactivated.

Pop-up indication is displayed for approx. 8 seconds in the Driver Information Centre.

### Fault

The traffic sign assistant system may not operate correctly when:

- the area of the windscreen, where the front camera is located, is not clean
- traffic signs are completely or partially covered or difficult to discern
- there are adverse environmental conditions like heavy rain, snow, direct sunlight or shadows. In this case **No Traffic Sign Detection due to Weather** is indicated on the display
- traffic signs are incorrectly mounted or damaged

- traffic signs do not comply with the Vienna Convention on traffic signs (Wiener Übereinkommen über Straßenverkehrszeichen)

### Caution

The system is intended to help the driver within a defined speed range to discern certain traffic signs. Do not ignore traffic signs which are not displayed by the system.

The system does not discern any other than the conventional traffic signs that might give or end a speed limit.

Do not let this special feature tempt you into taking risks when driving.

Always adapt speed to the road conditions.

The driver assistance systems do not relieve the driver from full responsibility for vehicle operation.

## Lane departure warning

The lane departure warning system observes the lane markings between which the vehicle is driving via a front camera. The system detects lane changes and warns the driver in the event of an unintended lane change via visual and acoustic signals.



Criteria for the detection of an unintended lane change are:

- no operation of turn signals
- no brake pedal operation
- no active accelerator operation or speeding-up
- no active steering

If the driver is active, no warning will be issued.

## Activation



The lane departure warning system is activated by pressing the  button. The illuminated LED in the button indicates that the system is switched on. When the control indicator  in the instrument cluster illuminates green, the system is ready to operate.

The system is only operable at vehicle speeds above 35 mph and if lane markings are available.

When the system recognises an unintended lane change, the control indicator  changes to yellow and flashes. Simultaneously a chime sound is activated.



### Deactivation

The system is deactivated by pressing  button, the LED in the button extinguishes.

At speeds below 35 mph the system is inoperable.

### Fault

The lane departure warning system may not operate properly when:

- the windscreen is not clean
- there are adverse environmental conditions like heavy rain, snow, direct sunlight or shadows

The system cannot operate when no lane marking is detected.

### Fuel

#### Fuel for petrol engines

Only use unleaded fuel that complies with EN 228.

Usage of fuel with quality, not complying to the Technical Regulations in effect (Decree № 118 of 27.02.2008 with amendments of 30.12.2008 № 1076) can lead to engine damage and loss of all warranty obligations.

Equivalent standardised fuels with an ethanol content of max. 10 % by volume may be used. In this case only use fuel that complies with E DIN 51626-1.

Use fuel with the recommended octane rating  $\geq$  205. Use of fuel with too low an octane rating can reduce engine power and torque and slightly increases fuel consumption.

**Caution**

Use of fuel that does not comply to EN 228 or similar can lead to deposits or engine damage and loss of warranty.

**Caution**

Use of fuel with too low an octane rating could lead to uncontrolled combustion and engine damage.

### Fuel for diesel engines

Only use diesel fuel that complies with EN 590.

Usage of fuel with quality, not complying to the Technical Regulations in effect (Decree № 118 of 27.02.2008 with amendments of 30.12.2008 № 1076) can lead to engine damage and loss of all warranty obligations.

In countries outside the European Union use Euro-Diesel fuel with a sulphur concentration below 50 ppm.

**Caution**

Use of fuel that does not comply to EN 590 or similar can lead to engine powerloss, increased wear or engine damage and loss of warranty.

Do not use marine diesel oils, heating oils, Aquazole and similar diesel-water emulsions. Diesel fuels must not be diluted with fuels for petrol engines.

### Refuelling



**⚠ Danger**

Before refuelling, switch off engine and any external heaters with combustion chambers. Switch off any mobile phones.

Follow the operating and safety instructions of the filling station when refuelling.

**⚠ Danger**

Fuel is flammable and explosive. No smoking. No naked flames or sparks.

If you can smell fuel in your vehicle, have the cause of this remedied immediately by an authorized dealer.

**Caution**

In case of misfuelling, do not switch on ignition.

Fuel filler flap is located at right rear side of vehicle.



The fuel filler flap can only be opened if the vehicle is unlocked. Release the fuel filler flap by pushing the flap.

To open, turn the cap slowly to the left.

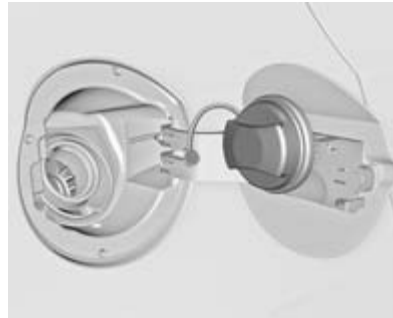

The fuel filler cap can be retained in the bracket on the fuel filler flap.

For refuelling, fully insert the pump nozzle and switch it on.

After automatic cut-off, it can be topped up with max. two doses of fuel.

### Caution

Wipe off any overflowing fuel immediately.

To close, turn the fuel filler cap to the right until it clicks.

Close the flap and let engage.

### Fuel filler cap

Only use genuine fuel filler caps. Diesel-engined vehicles have special fuel filler caps.

### Fuel consumption - CO<sub>2</sub>-Emissions

The minimum fuel consumption (combined) of the model Vauxhall Astra GTC is 63 mpg<sup>1)</sup>.

The minimum CO<sub>2</sub> emission (combined) is 119 g/km<sup>1)</sup>.

For the values specific for your vehicle, refer to the EEC Certificate of Conformity provided with your vehicle or other national registration documents.

### General information

The official fuel consumption and specific CO<sub>2</sub> emission figures quoted relate to the EU base model with standard equipment.

<sup>1)</sup> Maximum value was not available at time of printing.

Fuel consumption data and CO<sub>2</sub> emission data are determined according to regulation R (EC) No. 715/2007 (in the version respectively applicable), taking into consideration the vehicle weight in running order, as specified by the regulation.

The figures are provided only for the purpose of comparison between different vehicle variants and must not be taken as a guarantee for the actual fuel consumption of a particular vehicle. Additional equipment may result in slightly higher results than the stated consumption and CO<sub>2</sub> figures. Furthermore, fuel consumption is dependent on personal driving style as well as road and traffic conditions.

## **Towing**

### **General information**

Only use towing equipment that has been approved for your vehicle. Entrust retrofitting of towing equipment to a workshop. It may be necessary to make changes that affect the cooling system, heat shields or other equipment.

The bulb outage detection function for trailer brake light cannot detect a partial bulb outage, e.g. in case of 4 x 5 Watts it only detects lamp outage when only a 5 watt lamp remains or no lamp remains.

Fitting of towing equipment could cover the opening of the towing eye. If this is the case use the coupling ball bar for towing. Always keep the coupling ball bar in the vehicle.

Installation dimensions of factory-fitted towing equipment ⇨ 216.

### **Driving characteristics and towing tips**

Before attaching a trailer, lubricate the coupling ball. However, do not do so if a stabiliser, which acts on the coupling ball, is being used to reduce snaking movements.

For trailers with low driving stability and caravan trailers with a permitted gross vehicle weight of more than 1400 kg the use of a stabiliser is strongly recommended when driving above 50 mph.

If the trailer starts snaking, drive more slowly, do not attempt to correct the steering and brake sharply if necessary.

When driving downhill, drive in the same gear as if driving uphill and drive at a similar speed.

Adjust tyre pressure to the value specified for full load ⇨ 213.

## Trailer towing

### Trailer loads

The permissible trailer loads are vehicle and engine-dependent maximum values which must not be exceeded. The actual trailer load is the difference between the actual gross weight of the trailer and the actual coupling socket load with the trailer coupled.

The permissible trailer loads are specified in the vehicle documents. In general, they are valid for gradients up to max. 12 %.

The permitted trailer load applies up to the specified incline and up to an altitude of 1000 metres above sea level. Since engine power decreases as altitude increases due to the air becoming thinner, therefore reducing climbing ability, the permissible gross train weight also decreases by 10 % for every 1000 metres of additional altitude. The gross train weight does not have to be reduced when driving on roads with slight inclines (less than 8 %, e.g. motorways).

The permissible gross train weight must not be exceeded. This weight is specified on the identification plate ↗ 200.

### Vertical coupling load

The vertical coupling load is the load exerted by the trailer on the coupling ball. It can be varied by changing the weight distribution when loading the trailer.

The maximum permissible vertical coupling load (75 kg) is specified on the towing equipment identification plate and in the vehicle documents. Always aim for the maximum load, especially in the case of heavy trailers. The vertical coupling load should never fall below 25 kg.

### Rear axle load

When the trailer is coupled and the towing vehicle fully loaded, the permissible rear axle load (see identification plate or vehicle documents) may be exceeded by 70 kg, the gross vehicle weight rating may be exceeded by 70 kg. If the permissible rear axle load is exceeded, a maximum speed of 60 mph applies.

## Towing equipment

Caution
When operating without a trailer, remove the coupling ball bar.



### Stowage of coupling ball bar



The bag with the coupling ball bar is stowed in the rear stowage compartment on the floor.

Place the strap through the lashing eye, wrap around twice and tighten the strap to secure the bag.

### Fitting the coupling ball bar



Disengage and fold down the socket. Remove the sealing plug from the opening for the coupling ball bar and stow it.

### Checking the tensioning of the coupling ball bar



- Red marking on rotary knob must point towards green marking on coupling ball bar.
- The gap between the rotary knob and the coupling ball bar must be approx. 6 mm.
- The key must be in position .

Otherwise, the coupling ball bar must be tensioned before being inserted:

- Unlock coupling ball bar by turning key to position .

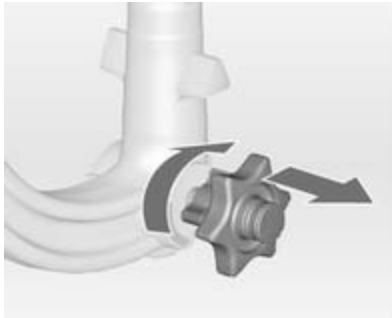

- Pull out rotary knob and turn clockwise as far as it will go.

#### Inserting the coupling ball bar



Insert the tensioned coupling ball bar in the opening and push firmly upwards until it audibly engages.

The rotary handle snaps back into its original position resting against the coupling ball bar without a gap.

#### **⚠ Warning**

Do not touch rotary handle during insertion.

Lock the coupling ball bar by turning the key to position . Remove the key and close the protective flap.

#### Eye for break-away stopping cable

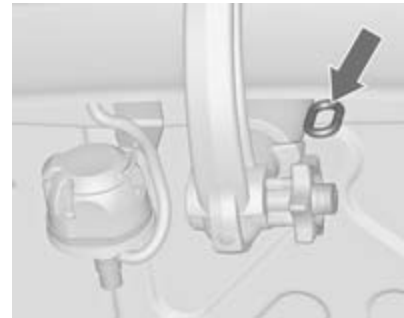

Attach breakaway stopping cable to eye.

#### Check that the coupling ball bar is correctly installed

- Green marking on rotary knob must point towards green marking on coupling ball bar.
- There must be no gap between the rotary handle and the coupling ball bar.

- The coupling ball bar must be firmly engaged in the opening.
- The coupling ball bar must be locked and the key removed.

**⚠ Warning**

Towing a trailer is permitted only when a coupling ball bar is fitted correctly. If the coupling ball bar does not engage correctly, seek the assistance of a workshop.

**Dismounting the coupling ball bar**

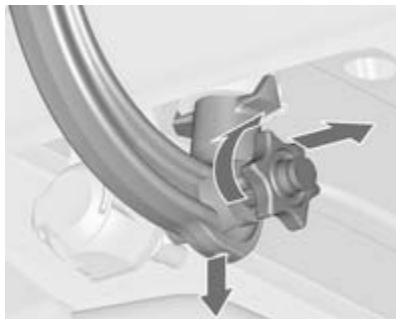

Open the protective flap and turn the key to position  to unlock the coupling ball bar.

Pull out rotary handle and turn clockwise as far as it will go. Pull out coupling ball bar downwards.

Insert sealing plug in opening. Fold away socket.

**Trailer stability assist**

If the system detects snaking movements, engine power is reduced and the vehicle/trailer combination is selectively braked until the snaking ceases. While system is working keep steering wheel as still as possible.

Trailer stability assist (TSA) is a function of the Electronic Stability Control  134.

## Vehicle care

General Information .....	155
Vehicle checks .....	156
Bulb replacement .....	163
Electrical system .....	171
Vehicle tools .....	177
Wheels and tyres .....	177
Jump starting .....	190
Towing .....	191
Appearance care .....	193

## General Information

### Accessories and vehicle modifications

We recommend the use of genuine parts and accessories and factory approved parts specific for your vehicle type. We cannot assess or guarantee reliability of other products - even if they have a regulatory or otherwise granted approval.

Do not make any modifications to the electrical system, e.g. changes of electronic control units (chip tuning).

#### Caution

When transporting the vehicle on a train or on a recovery vehicle, the mud flaps might be damaged.

## Vehicle storage

### Storage for a long period of time

If the vehicle is to be stored for several months:

- Wash and wax the vehicle.
- Have the wax in the engine compartment and underbody checked.
- Clean and preserve the rubber seals.
- Fill up fuel tank completely.
- Change the engine oil.
- Drain the washer fluid reservoir.
- Check the coolant antifreeze and corrosion protection.
- Adjust tyre pressure to the value specified for full load.
- Park the vehicle in a dry, well ventilated place. Engage first or reverse gear or set selector lever to **P**. Prevent the vehicle from rolling.
- Do not apply the parking brake.
- Open the bonnet, close all doors and lock the vehicle.

- Disconnect the clamp from the negative terminal of the vehicle battery. Beware that all systems are not functional, e.g. anti-theft alarm system.

### Putting back into operation

When the vehicle is to be put back into operation:

- Connect the clamp to the negative terminal of the vehicle battery. Activate the electronics of the power windows.
- Check tyre pressure.
- Fill up the washer fluid reservoir.
- Check the engine oil level.
- Check the coolant level.
- Fit the number plate if necessary.

### End-of-life vehicle recovery

Information on end-of-life vehicle recovery centres and the recycling of end-of-life vehicles is available on our website. Only entrust this work to an authorised recycling centre.

## Vehicle checks

### Performing work



#### **⚠ Warning**

Only perform engine compartment checks when the ignition is off.  
The cooling fan may start operating even if the ignition is off.

#### **⚠ Danger**

The ignition system and Xenon headlights use extremely high voltage. Do not touch.

## Bonnet

### Opening



Pull the release lever and return it to its original position.



Push the safety catch to the right and open the bonnet.

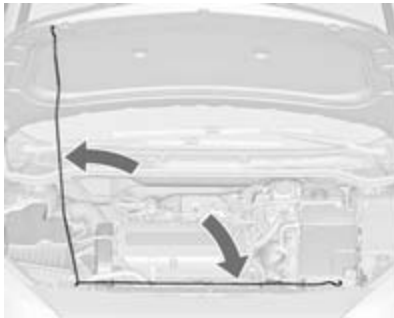

Secure the bonnet support.

If the bonnet is opened during an Autostop, the engine will be restarted automatically for safety reasons.

### Closing

Before closing the bonnet, press the support into the holder.

Lower the bonnet and allow it to drop into the catch. Check that the bonnet is engaged.

### Engine oil

Check the engine oil level manually on a regular basis to prevent damage to the engine. Ensure that the correct specification of oil is used. Recommended fluids and lubricants ⇨ 198.

Check with the vehicle on a level surface. The engine must be at operating temperature and switched off for at least 5 minutes.

Pull out the dipstick, wipe it clean, insert it to the stop on the handle, pull out and read the engine oil level.

### Caution

It is the owner's responsibility to maintain the proper level of an appropriate quality oil in the engine.

Insert dipstick to the stop on the handle and make half a turn.

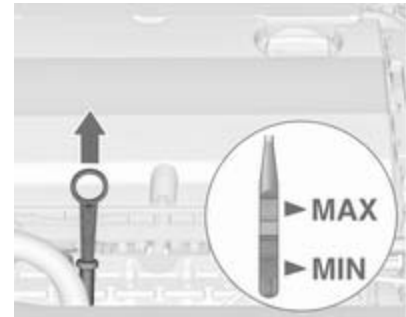

Different dipsticks are used depending on engine variant.

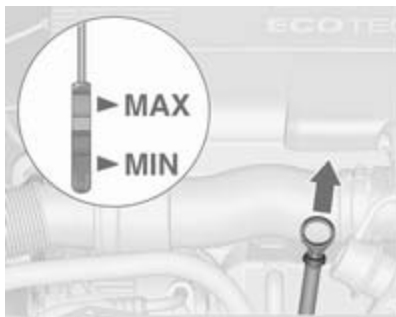

When the engine oil level has dropped to the **MIN** mark, top up engine oil.

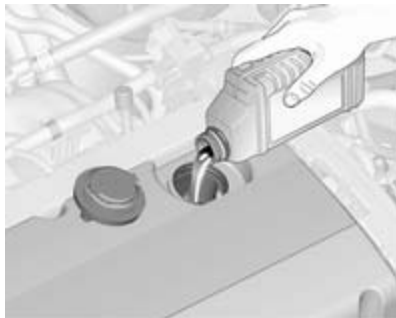

We recommend the use of the same grade of engine oil that was used at last change.

The engine oil level must not exceed the **MAX** mark on the dipstick.

**Caution**

Overfilled engine oil must be drained or suctioned out.

Capacities ⇨ 212.

Fit the cap on straight and tighten it.

**Engine coolant**

The coolant provides freeze protection down to approx. -28 °C. In northern countries with very low temperatures the factory filled coolant provides frost protection down to approx. -37°C.

**Caution**

Only use approved antifreeze.

**Coolant level**

**Caution**

Too low a coolant level can cause engine damage.

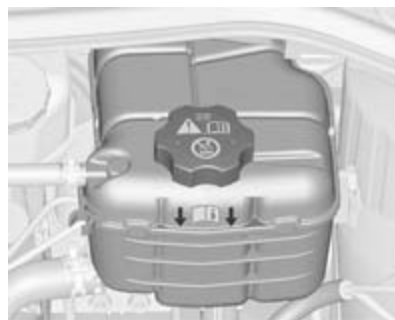

If the cooling system is cold, the coolant level should be above the filling line mark. Top up if the level is low.

**⚠ Warning**

Allow the engine to cool before opening the cap. Carefully open the cap, relieving the pressure slowly.

To top up use a 1:1 mixture of released coolant concentrate mixed with clean tap water. If no coolant concentrate is available, use clean tap water. Install the cap tightly. Have the coolant concentration checked and have the cause of the coolant loss remedied by a workshop.

**Washer fluid**

Fill with clean water mixed with a suitable quantity of windscreen washer fluid which contains antifreeze. For the correct mixing ratio refer to the washer fluid container.

**Caution**

Only washer fluid with a sufficient antifreeze concentration provides protection at low temperatures or a sudden drop in temperature.

**Brakes**

In the event of minimum thickness of the brake lining, a squealing noise sounds during braking.

Continued driving is possible but have the brake lining replaced as soon as possible.

Once new brake linings are installed, do not brake unnecessarily hard for the first few journeys.

**Brake fluid****⚠ Warning**

Brake fluid is poisonous and corrosive. Avoid contact with eyes, skin, fabrics and painted surfaces.





The brake fluid level must be between the **MIN** and **MAX** marks.

When topping up, ensure maximum cleanliness as contamination of the brake fluid can lead to brake system malfunctions. Have the cause of the loss of brake fluid remedied by a workshop.

Only use high-performance brake fluid approved for the vehicle. Brake and clutch fluid ⇨ 198.

## Battery

The vehicle battery is maintenance-free provided that the driving profile allows sufficient charging of the battery. Short-distance-driving and frequent engine starts can discharge the battery. Avoid the use of unnecessary electrical consumers.



Batteries do not belong in household waste. They must be disposed of at an appropriate recycling collection point.

Laying up the vehicle for more than 4 weeks can lead to battery discharge. Disconnect the clamp from the negative terminal of the vehicle battery.

Ensure the ignition is switched off before connecting or disconnecting the vehicle battery.

The anti-theft alarm siren must be deactivated as follows: Switch the ignition on then off, disconnect the vehicle's battery within 15 seconds. Battery discharge protection ⇨ 110.

## Replacing the battery

### Note

Any deviation from the instructions given in this paragraph may lead to a temporary deactivation of the stop-start system.

When the battery is being replaced, please ensure that there are no open ventilation holes in the vicinity of the positive terminal. If a ventilation hole is open in this area, it must be closed off with a dummy cap, and the ventilation in the vicinity of the negative terminal must be opened.

Only use batteries that allow the fuse box to be mounted above the battery.

In vehicles with stop-start system, ensure to have the AGM (Absorbent Glass Mat) battery replaced with an AGM battery again.



An AGM battery can be identified by the label on the battery. We recommend the use of an original Vauxhall battery.

#### Note

Using an AGM battery different from the original Vauxhall battery might result in a lower performance of the stop-start system.

We recommend that you have the battery replaced by a workshop.

Stop-start system ⇨ 123.

## Charging the battery

### ⚠ Warning

On vehicles with stop-start system, ensure that the charging potential does not exceed 14.6 volts when using a battery charger. Otherwise the battery might be damaged.

Jump starting ⇨ 190.

## Warning label



Meaning of symbols:

- No sparks, naked flames or smoking.
- Always shield eyes. Explosive gases can cause blindness or injury.
- Keep the battery out of reach of children.
- The battery contains sulfuric acid which could cause blindness or serious burn injuries.
- See the Owner's Manual for further information.
- Explosive gas may be present in the vicinity of the battery.

## Diesel fuel system bleeding

If the tank has been run dry, the diesel fuel system must be bled. Switch on the ignition three times for 15 seconds at a time. Then start the engine for a maximum of 40 seconds. Repeat this process after no less than 5 seconds. If the engine fails to start, seek the assistance of a workshop.

## Wiper blade replacement



Lift the wiper arm until it stays in the raised position, press button to disengage the wiper blade and remove.

Attach the wiper blade slightly angled to the wiper arm and push until it engages.

Lower wiper arm carefully.

## Wiper blade on the rear window



Lift wiper arm. Disengage wiper blade as shown in illustration and remove.

Attach the wiper blade slightly angled to the wiper arm and push until it engages.

Lower wiper arm carefully.

## Bulb replacement

Switch off the ignition and switch off the relevant switch or close the doors.

Only hold a new bulb at the base! Do not touch the bulb glass with bare hands.

Use only the same bulb type for replacement.

Replace headlight bulbs from within the engine compartment.

### Bulb check

After a bulb replacement switch on the ignition, operate and check the lights.

## Halogen headlights



**Bi-Halogen Headlight (1)** with one bulb for low and high beam.

**Front turn signal (2).**

**Sidelight/Daytime running light (3).**

## Low/High beam (1)



1. Rotate the cap (1) anticlockwise and remove it.

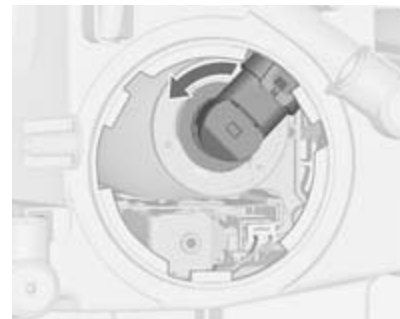

2. Rotate the bulb holder anticlockwise to disengage. Withdraw the bulb holder from the reflector.

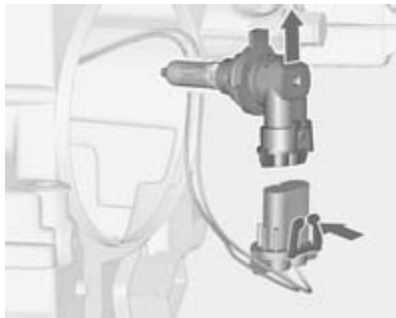

3. Disengage the bulb holder from the plug connector by pressing the retaining lug.
4. Replace the bulb and connect bulb holder with the plug connector.
5. Insert the bulb holder, engaging the two lugs into the reflector and rotate clockwise to secure.
6. Fit the cap and rotate clockwise.

### Front turn signal (2)



1. Rotate cap (2) anticlockwise and remove it.



2. Rotate bulb holder anticlockwise and remove.

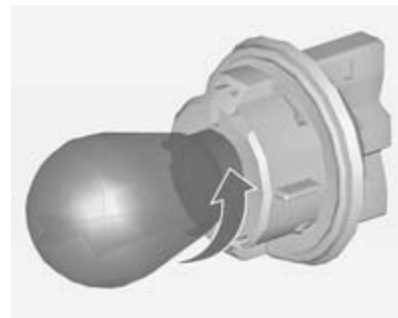

3. Remove the bulb from the socket by turning anticlockwise.
4. Replace and insert new bulb into socket by turning clockwise.
5. Insert the bulb holder into the reflector and turn clockwise.
6. Fit the cap and rotate clockwise.

### Sidelight/Daytime running light (3)



1. Rotate bulb socket (3) anticlockwise to disengage. Withdraw the bulb socket from the reflector.



2. Remove the bulb from the socket by pulling.
3. Replace and insert new bulb into socket.
4. Insert the bulb socket into the reflector and turn clockwise.

### Adaptive forward lighting

#### **⚠ Danger**

Adaptive forward lighting system uses Xenon headlights.

Xenon headlights work under extremely high electrical voltage. Do not touch. Have bulbs replaced by a workshop.

Bulbs for front turn signal and corner lighting can be changed.

Sidelight/Daytime running lights are designed as Light Emitting Diodes (LEDs) and cannot be changed.

### Cornering light

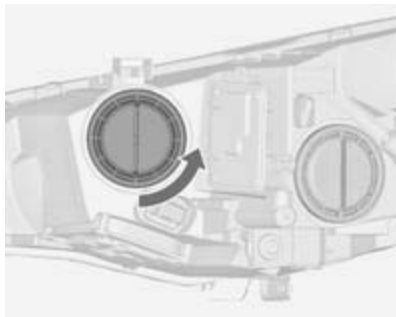

1. Rotate the cap anticlockwise and remove it.



2. Rotate the bulb holder anticlockwise to disengage. Withdraw the bulb holder from the reflector.

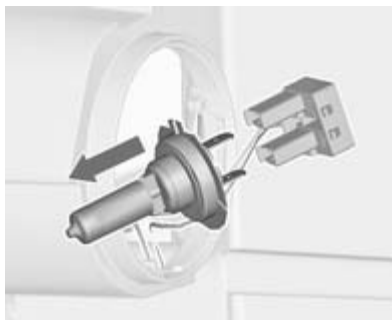

3. Disengage the bulb from the plug connector by pulling.
4. Replace the bulb and connect bulb holder with the plug connector.
5. Insert the bulb holder, engaging the two lugs into the reflector and rotate clockwise to secure.
6. Fit the cap and rotate clockwise.

### Front turn signal

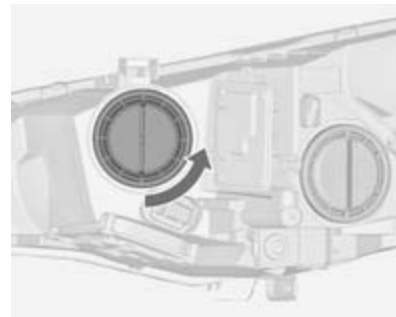

1. Rotate the cap anticlockwise and remove it.



2. Rotate bulb socket anticlockwise to disengage. Withdraw the bulb socket from the reflector.

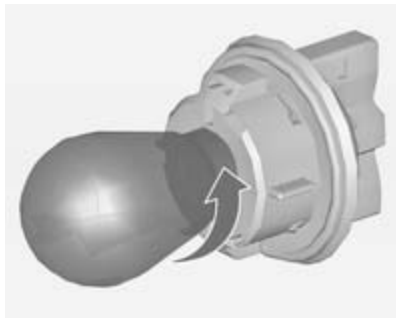

3. Remove the bulb from the socket by turning anticlockwise.
4. Replace and insert new bulb into socket by turning clockwise.
5. Insert the bulb socket into the reflector and turn clockwise.
6. Fit the cap and rotate clockwise.

## Fog lights



1. Disengage the cover with a screwdriver in the recess and remove the cover.



2. Unscrew both screws and remove light assembly.

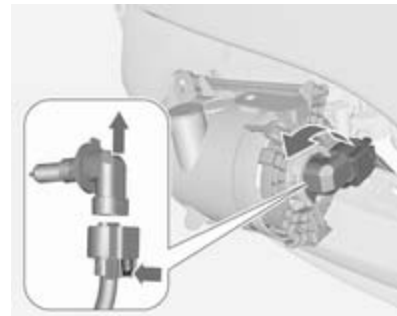



3. Turn the bulb holder anti-clockwise and remove it from the reflector.
4. Disengage the bulb socket from the plug connector by pressing the retaining lug.
5. Remove and replace the bulb socket with bulb and attach the plug connector.
6. Insert the bulb socket into the reflector by turning clockwise and engage.
7. Mount the light assembly by tightening both screws.
8. Assemble and engage the cover.

## Tail lights



1. Release the cover and remove it.



2. Unscrew both plastic securing nuts from the inside by hand.

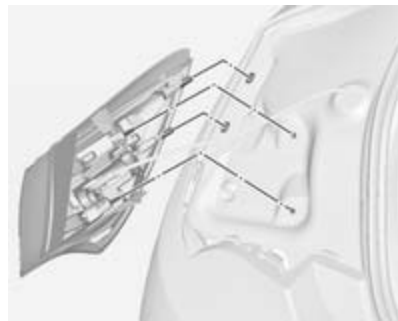

3. Carefully withdraw the light assembly from retaining pins and remove.
4. Detach the plug connector from the light assembly.

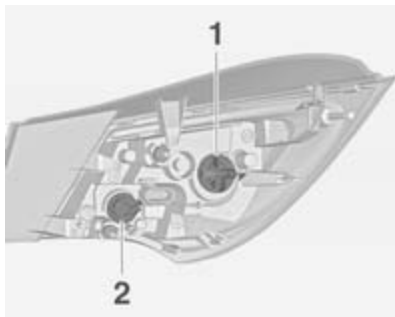

5. Remove and replace the bulb by turning the bulb socket anti-clockwise.

Tail light/Brake light (1)

Turn signal light (2)

#### **Tail lights with Light Emitting Diode (LED) for tail and brake light**

Only turn signal light (2) can be changed.

6. Insert and turn bulb holder clockwise into the tail light assembly.
7. Connect the plug connector with the light assembly.

8. Fit light assembly onto retaining pins and tighten the securing nuts.
9. Close the cover and engage.

#### **Lights in the tailgate**

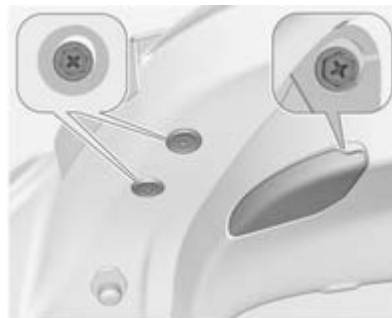

1. Open the tailgate and remove the covers.
2. Unscrew three screws.
3. Remove the tail light assembly.

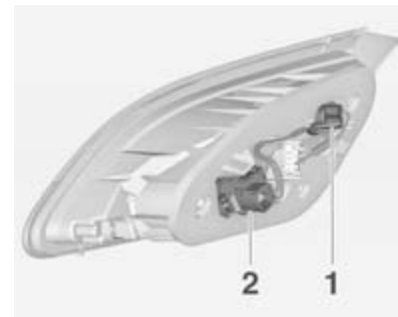

4. Turn bulb holder anti-clockwise and remove it from the reflector.

Replace the bulb:

Tail light (1)

Rear fog light (2) (only one side)

Reverse light (2) (only one side)

#### **Tail lights with Light Emitting Diode (LED)**

Only rear fog light resp. reverse light (2) can be changed.

5. Replace and insert new bulb into socket.
6. Insert the bulb socket into the reflector and turn clockwise.

7. Install the tail light assembly in the tailgate and tighten the screws.
8. Attach all covers.

## Side turn signal lights

Have bulbs replaced by a workshop.

## Number plate light

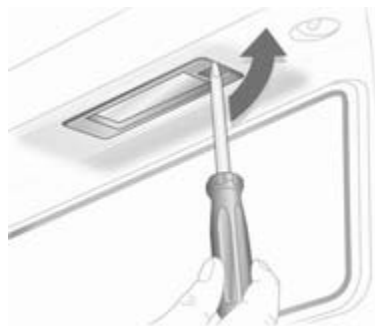

1. Insert screwdriver in recess of the cover, press to the side and release spring. Remove cover.
2. Remove the bulb holder downwards, taking care not to pull on the cable.



3. Disengage the retaining lug and remove the bulb holder from the wiring plug.
4. Remove and replace the bulb holder with bulb.
5. Connect the wiring plug to the bulb holder.
6. Push the bulb holder into the housing and close the cover.

## Interior lights

### Courtesy light, reading lights

Have bulbs replaced by a workshop.

### Load compartment light

Have bulbs replaced by a workshop.

### Instrument panel illumination

Have bulbs replaced by a workshop.

## Electrical system

### Fuses

Data on the replacement fuse must match the data on the defective fuse.

There are three fuse boxes in the vehicle:

- in the front left of the engine compartment,
- in left-hand drive vehicles, in the interior behind the storage compartment, or, in right-hand drive vehicles, behind the glovebox,
- behind a cover on the left side of the load compartment.

Before replacing a fuse, turn off the respective switch and the ignition.

A blown fuse can be recognized by its melted wire. Do not replace the fuse until the cause of the fault has been remedied.

Some functions are protected by several fuses.

Fuses may also be inserted without existence of a function.

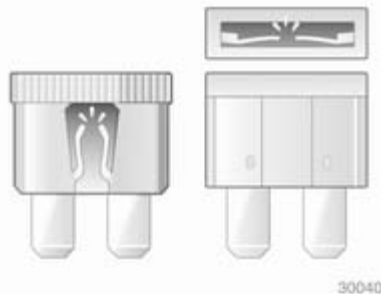

### Fuse extractor

A fuse extractor may be located in the fuse box in the engine compartment.

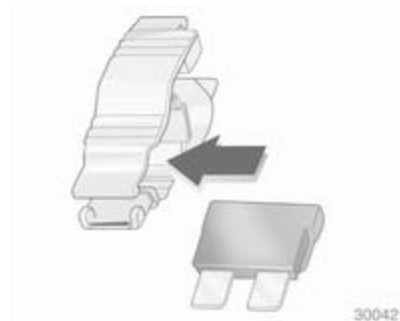
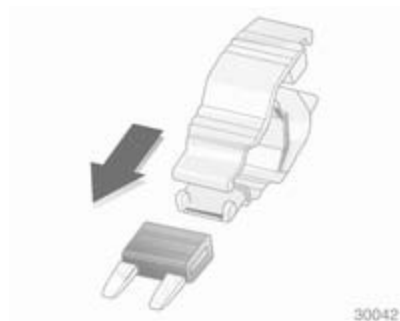



30044

Place the fuse extractor on the various types of fuse from the top or side, and withdraw fuse.

## Engine compartment fuse box

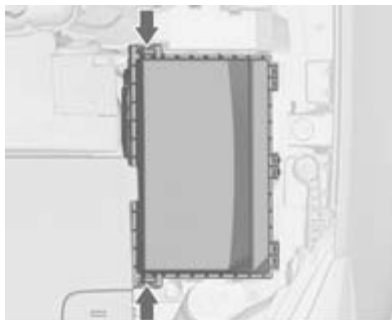

The fuse box is in the front left of the engine compartment.

Disengage the cover and fold it upwards until it stops. Remove the cover vertically upwards.

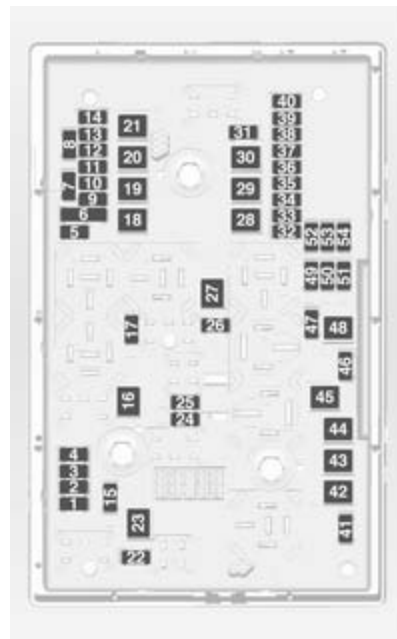

**No. Circuit**

- 1 Engine control module
- 2 Lambda probe
- 3 Fuel injection, ignition system
- 4 Fuel injection, ignition system
- 5 –
- 6 Mirror heating
- 7 Fan control
- 8 Lambda probe, engine
- 9 Rear window sensor
- 10 Battery sensor
- 11 Trunk release
- 12 Adaptive forward lighting module
- 13 –
- 14 Rear window wiper
- 15 Engine control module
- 16 Starter

**No. Circuit**

- 17 Transmission control module
- 18 Heated rear window
- 19 Front power windows
- 20 Rear power windows
- 21 ABS
- 22 Left high beam (Halogen)
- 23 Headlamp washer system
- 24 Right low beam (Xenon)
- 25 Left low beam (Xenon)
- 26 Fog lights
- 27 Diesel fuel heating
- 28 –
- 29 Electrical parking brake
- 30 ABS
- 31 –
- 32 Airbag
- 33 Adaptive forward lighting

**No. Circuit**

- 34 –
- 35 Power windows
- 36 –
- 37 Canister vent solenoid
- 38 Vacuum pump
- 39 Fuel system control module
- 40 Windscreen washer, Rear window washer system
- 41 Right high beam (Halogen)
- 42 Radiator fan
- 43 Windscreen wiper
- 44 –
- 45 Radiator fan
- 46 –
- 47 Horn
- 48 Radiator fan
- 49 Fuel pump

**No. Circuit**

- 50 Headlamp levelling
- 51 Air shutter
- 52 Auxiliary heater, diesel engine
- 53 Transmission control module,  
Engine control module
- 54 Wiring monitoring

After having changed defective fuses close the fuse box cover and press until it engages.

If the fuse box cover is not closed correctly, malfunction may occur.

**Instrument panel fuse box**



In left-hand drive vehicles, the fuse box is behind the storage compartment in the instrument panel. Open the compartment and push it to the left to unlock. Fold the compartment down and remove it.



In right-hand drive vehicles, the fuse box is located behind a cover in the glovebox. Open the glovebox, then open the cover and fold it down.



**No. Circuit**

- 1 Displays
- 2 Exterior lights
- 3 Exterior lights
- 4 Radio
- 5 Infotainment system, instrument
- 6 Power outlet front
- 7 Power outlet rear seat
- 8 Left low beam
- 9 Right low beam
- 10 Door locks
- 11 Interior fan
- 12 –
- 13 –
- 14 Diagnostic connector
- 15 Airbag
- 16 –

**No. Circuit**

- 17 Air conditioning system
- 18 Prefuse: radio, Infotainment, displays
- 19 Brake lights, tail lights, interior lights
- 20 –
- 21 –
- 22 Ignition switch
- 23 Body control unit
- 24 Body control unit
- 25 –
- 26 Power outlet load compartment

**Load compartment fuse box**

The fuse box is on the left side of the load compartment behind a cover.



Remove the cover.

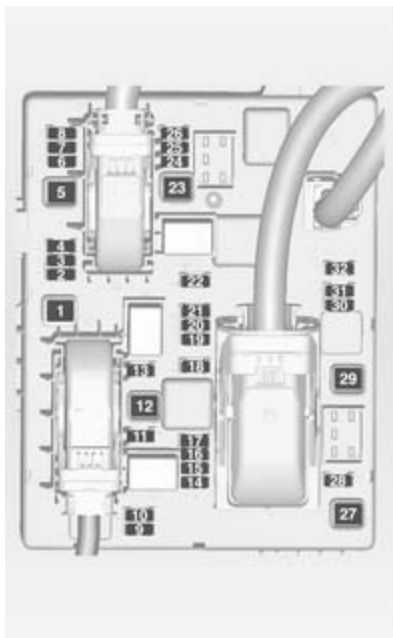

## Fuse assignments

**No. Circuit**

- |    |                                |
|----|--------------------------------|
| 1  | Trailer module                 |
| 2  | Trailer outlet                 |
| 3  | Parking assist                 |
| 4  | -                              |
| 5  | -                              |
| 6  | -                              |
| 7  | -                              |
| 8  | Anti-theft alarm system        |
| 9  | -                              |
| 10 | -                              |
| 11 | Trailer module, Trailer socket |
| 12 | -                              |
| 13 | Trailer outlet                 |
| 14 | -                              |
| 15 | -                              |
| 16 | -                              |
| 17 | -                              |

**No. Circuit**

- |    |   |
|----|---|
| 18 | -   |
| 19 | Steering wheel heating                        |
| 20 | -   |
| 21 | Seat heating                                  |
| 22 | -   |
| 23 | -   |
| 24 | -   |
| 25 | -   |
| 26 | -   |
| 27 | -   |
| 28 | -   |
| 29 | -   |
| 30 | -   |
| 31 | Amplifier, Subwoofer                          |
| 32 | Active damping system, Lane departure warning |

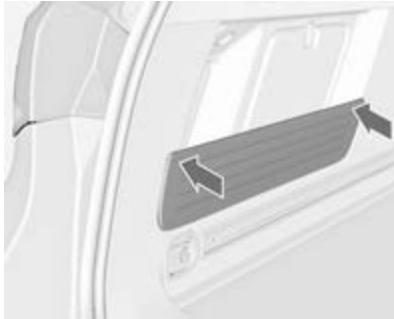

When assembling press the blind into the rubber grommets to reach full retention force.

## Vehicle tools

### Tools

#### Vehicles with tyre repair kit

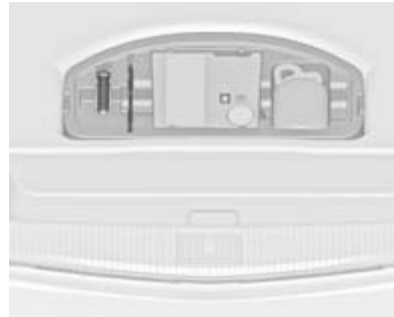

The tools and tyre repair kit are in a storage compartment below the floor cover in the load compartment.

#### Vehicles with spare wheel

The jack, the tools and a strap for securing a damaged wheel are in a storage compartment below the spare wheel in the load compartment. Spare wheel ↪ 187.

## Wheels and tyres

### Tyre condition, wheel condition

Drive over edges slowly and at right angles if possible. Driving over sharp edges can cause tyre and wheel damage. Do not trap tyres on the kerb when parking.

Regularly check the wheels for damage. Seek the assistance of a workshop in the event of damage or unusual wear.

### Winter tyres

Winter tyres improve driving safety at temperatures below 7 °C and should therefore be fitted on all wheels.

In accordance with country-specific regulations, affix the speed sticker in the driver's field of view.

VXR Version: only tyres of size 235/45 R18 are permitted as winter tyres.

## Tyre designations

E.g. 215/60 R 16 95 H

**215** = Tyre width, mm

**60** = Cross-section ratio (tyre height to tyre width), %

**R** = Belt type: Radial

**RF** = Type: RunFlat

**16** = Wheel diameter, inches

**95** = Load index e.g. 95 is equivalent to 690 kg

**H** = Speed code letter

Speed code letter:

**Q** = up to 100 mph

**S** = up to 112 mph

**T** = up to 118 mph

**H** = up to 130 mph

**V** = up to 150 mph

**W** = up to 168 mph

## Tyre pressure

Check the pressure of cold tyres at least every 14 days and before any long journey. Do not forget the spare wheel. This also applies to vehicles with tyre pressure monitoring system.

Unscrew the valve cap.



Tyre pressure ⇨ 213 and on the label on the front left door frame.

The tyre pressure data refers to cold tyres. It applies to summer and winter tyres.

Always inflate the spare tyre to the pressure specified for full load.

The ECO tyre pressure serves to achieve the smallest amount of fuel consumption possible.

Incorrect tyre pressures will impair safety, vehicle handling, comfort and fuel economy and will increase tyre wear.

### ⚠ Warning

If the pressure is too low, this can result in considerable tyre warm-up and internal damage, leading to tread separation and even to tyre blow-out at high speeds.

If the tyre pressure shall be reduced or increased on a vehicle with tyre pressure monitoring system, switch off ignition.

## Tyre pressure monitoring system

The tyre pressure monitoring system checks the pressure of all four wheels once a minute when vehicle speed exceeds a certain limit.

All wheels must be equipped with pressure sensors and the tyres must have the prescribed pressure.

The current tyre pressures can be shown in the **Vehicle Information Menu** in the Driver Information Centre.

The menu can be selected by the buttons on the turn signal lever.

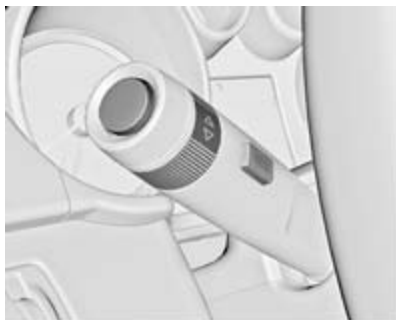

Press the **MENU** button to select the **Vehicle Information Menu** .

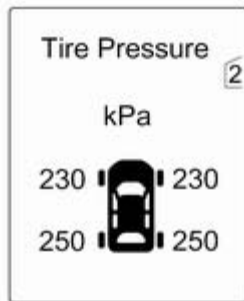

Turn the adjuster wheel to select the tyre pressure monitoring system.

System status and small pressure differences are displayed by a warning message with the corresponding tyre flashing in the Driver Information Centre.

Furthermore considerable pressure differences between the tyres on one axle are displayed by a warning message in the Driver Information Centre.

Major pressure differences are indicated additionally by the control indicator .

Control indicator   79.

Vehicle messages  86.

If the tyre pressure must be reduced or increased, switch off ignition.

If a complete set of wheels without sensors is mounted (e.g. four winter tyres), a message is displayed in the Driver Information Centre. The tyre pressure monitoring system is not operational. Retrofitting of sensors is possible.

A spare wheel or temporary spare wheel is not equipped with pressure sensors. The tyre pressure monitoring system is not operational for these wheels. Control indicator  illuminates. For the further three wheels the system remains operational.

The use of commercially available liquid tyre repair kits can impair the function of the system. Factory approved repair kits can be used.

External high-power radio equipment could disrupt the tyre pressure monitoring system.

The tyre pressure monitoring system valve cores and sealing rings must be replaced each time the tyres are changed.

### Adaptive threshold function

The tyre pressure monitoring system automatically detects if the vehicle is driven with a tyre pressure appropriate for a load of up to 3 people or for a full load.

If the tyre pressure must be reduced, switch off ignition before reducing.

### Auto learn function

After changing wheels, the vehicle must be stationary for approx. 20 minutes before the system recalculates. The following relearn process takes up to 10 minutes of driving with a minimum speed of 12 mph. In this case -- can be displayed or pressure values can swap in the Driver Information Centre.

If problems occur during the relearn process a warning message is displayed in the Driver Information Centre.

### Temperature compensation

Cold tyres decrease the tyre pressure, warm tyres increase the tyre pressure. The tyre pressure monitoring system considers this effect for the warning messages.

The tyre pressure value displayed in the Driver Information Centre shows the actual tyre pressure. Therefore it is important to check tyre pressure with cold tyres.

### Tread depth

Check tread depth at regular intervals.

Tyres should be replaced for safety reasons at a tread depth of 2-3 mm (4 mm for winter tyres).

For safety reasons it is recommended that the tread depth of the tyres on one axle should not vary by more than 2 mm.



The legally permissible minimum tread depth (1.6 mm) has been reached when the tread has worn down as far as one of the tread wear indicators (TWI). Their position is indicated by markings on the sidewall.

If there is more wear at the front than the rear, swap round front wheels and rear wheels periodically. Ensure that the direction of rotation of the wheels is the same as before.

Tyres age, even if they are not used. We recommend tyre replacement every 6 years.

## Changing tyre and wheel size

If tyres of a different size than those fitted at the factory are used, it may be necessary to reprogramme the speedometer as well as the nominal tyre pressure and make other vehicle modifications.

After converting to a different tyre size, have the label with tyre pressures replaced.

### ⚠ Warning

Use of unsuitable tyres or wheels may lead to accidents and will invalidate the vehicle type approval.

## Wheel covers

Wheel covers and tyres that are factory approved for the respective vehicle and comply with all of the relevant wheel and tyre combination requirements must be used.

If the wheel covers and tyres used are not factory approved, the tyres must not have a rim protection ridge.

Wheel covers must not impair brake cooling.

### ⚠ Warning

Use of unsuitable tyres or wheel covers could lead to sudden pressure loss and thereby accidents.

## Tyre chains

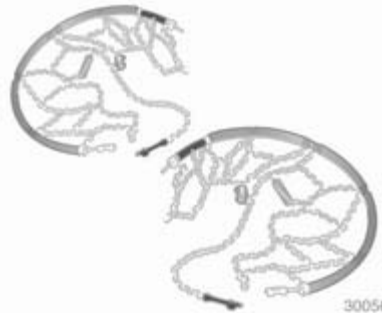

Use tyre chains only on front wheels.

Tyre chains are permitted on tyres of size 225/55 R 17 and 235/45 R18. Always use fine mesh chains that add no more than 10 mm to the tyre tread and the inboard sides (including chain lock).

### ⚠ Warning

Damage may lead to tyre blowout.

On tyres of size 245/45 R 18, special snow chains are only permitted when they are designed with a rotating chain belt on the tyre tread, no chain links on the wheel inboard sides and the chains add no more than 12 mm to the tyre tread. For further information of right snow chain usage for this tyre size, contact a specialized vehicle parts dealer or snow chain manufacturer.

Tyre chains are not permitted on tyres of size 235/55 R 17, 235/50 R 18, 235/45 R 19, 245/40 R 20.

The use of tyre chains is not permitted on the temporary spare wheel.

## Tyre repair kit

Minor damage to the tyre tread can be repaired with the tyre repair kit.

Do not remove foreign bodies from the tyres.

Tyre damage exceeding 4 mm or that is at tyre's sidewall cannot be repaired with the tyre repair kit.

### Warning

Do not drive faster than 50 mph.  
Do not use for a lengthy period.  
Steering and handling may be affected.

If you have a flat tyre:

Apply the parking brake and engage first gear, reverse gear or **P**.

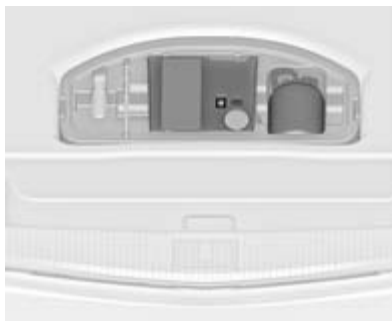

The tyre repair kit is in a compartment under the floor cover in the load compartment.

1. Take the tyre repair kit from the compartment.
2. Remove the compressor.



30057

3. Remove the electrical connection cable and air hose from the storage compartments on the underside of the compressor.



30058

4. Screw the compressor air hose to the connection on the sealant bottle.
5. Fit the sealant bottle into the retainer on the compressor.  
Set the compressor near the tyre in such a way that the sealant bottle is upright.

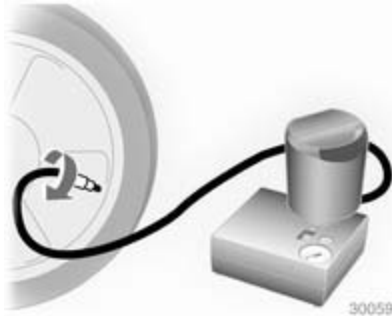

6. Unscrew valve cap from defective tyre.
7. Screw the filler hose to the tyre valve.
8. The switch on the compressor must be set to O.

9. Connect the compressor plug to the power outlet or cigarette lighter socket.  
To avoid discharging the battery, we recommend running the engine.

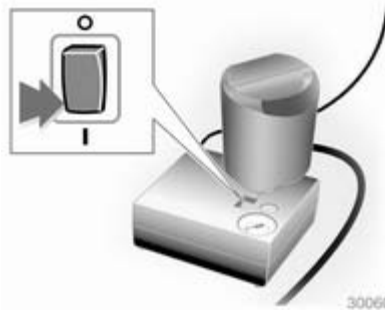

10. Set the rocker switch on the compressor to I. The tyre is filled with sealant.
11. The compressor pressure gauge briefly indicates up to 6 bar whilst the sealant bottle is emptying (approx. 30 seconds). Then the pressure starts to drop.

12. All of the sealant is pumped into the tyre. Then the tyre is inflated.
13. The prescribed tyre pressure should be obtained within 10 minutes. Tyre pressure  $\varnothing$  213. When the correct pressure is obtained, switch off the compressor.



If the prescribed tyre pressure is not obtained within 10 minutes, remove the tyre repair kit. Move the vehicle one tyre rotation. Reattach the tyre repair kit and continue the filling procedure for 10 minutes. If the prescribed tyre pressure is still not obtained, the



tyre is too badly damaged. Seek the assistance of a workshop.

Drain excess tyre pressure with the button over the pressure indicator.

Do not run the compressor longer than 10 minutes.

14. Detach the tyre repair kit. Push catch on bracket to remove sealant bottle from bracket. Screw the tyre inflation hose to the free connection of the sealant bottle. This prevents sealant from escaping. Stow tyre repair kit in load compartment.
15. Remove any excess sealant using a cloth.
16. Take the label indicating maximum permitted speed from the sealant bottle and affix in the driver's field of view.
17. Continue driving immediately so that sealant is evenly distributed in the tyre. After driving approx. 6 miles (but no more than 10 minutes), stop and check tyre pressure. Screw compressor air

hose directly onto tyre valve and compressor when doing this.

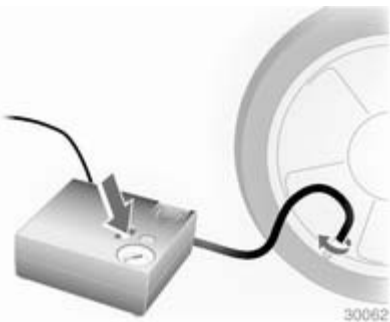

If tyre pressure is more than 1.3 bar, set it to the correct value. Repeat the procedure until there is no more loss of pressure.

If the tyre pressure has fallen below 1.3 bar, the vehicle must not be used. Seek the assistance of a workshop.

18. Stow away tyre repair kit in load compartment.

#### Note

The driving characteristics of the repaired tyre are severely affected, therefore have this tyre replaced.

If unusual noise is heard or the compressor becomes hot, turn compressor off for at least 30 minutes.

The built-in safety valve opens at a pressure of 102 psi.

Note the expiry date of the kit. After this date its sealing capability is no longer guaranteed. Pay attention to storage information on sealant bottle.

Replace the used sealant bottle. Dispose of the bottle as prescribed by applicable laws.

The compressor and sealant can be used from approx. -30 °C.

The adapters supplied can be used to pump up other items e.g. footballs, air mattresses, inflatable dinghies etc. They are located on the underside of the compressor. To remove, screw on compressor air hose and withdraw adapter.

## Wheel changing

Some vehicles are equipped with a tyre repair kit instead of a spare wheel ⇨ 182.

Make the following preparations and observe the following information:

- Park the vehicle on a level, firm and non-skid surface. The front wheels must be in the straight-ahead position.
- Apply the parking brake and engage first gear, reverse gear or **P**.
- Remove the spare wheel ⇨ 187.
- Never change more than one wheel at once.
- Use the jack only to change wheels in case of puncture, not for seasonal winter or summer tyre change.
- If the ground on which the vehicle is standing is soft, a solid board (max. 1 cm thick) should be placed under the jack.
- No people or animals may be in the vehicle when it is jacked-up.
- Never crawl under a jacked-up vehicle.
- Do not start the vehicle when it is raised on the jack.

- Clean wheel nuts and thread with a clean cloth before mounting the wheel.

**Warning**

Do not grease wheel bolt, wheel nut and wheel nut cone.



1. Disengage wheel nut caps with a screwdriver and remove. Pull off the wheel cover with the hook. Vehicle tools ⇨ 177.

Alloy wheels: Disengage wheel nut caps with a screwdriver and remove. To protect the wheel,

place a soft cloth between the screwdriver and the alloy wheel.

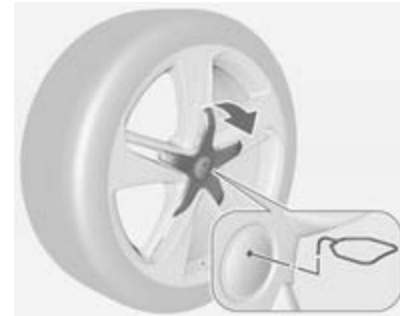

Alloy wheels with centre wheel bolt cap: Disengage centre cap by inserting and pulling the extractor ⇨ 177 in the recess of the brand emblem.



2. Install the wheel wrench ensuring that it locates securely and loosen each wheel nut by half a turn.



3. Ensure the jack is correctly positioned under the relevant vehicle jacking point. On versions with sill panelling: firstly pull out the cover on the sill panelling at the respective jacking point.

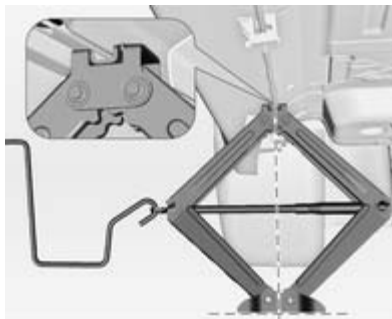

4. Set the jack to the necessary height. Position it directly below the jacking point in a manner that prevents it from slipping.



Attach jack handle and with the jack correctly aligned rotate handle until wheel is clear of the ground.

5. Unscrew the wheel nuts.  
 6. Change the wheel. Spare wheel ↗ 187.  
 7. Screw on the wheel nuts.  
 8. Lower vehicle. On versions with sill panelling install the cover at the jacking point.  
 9. Install the wheel wrench ensuring that it locates securely and tighten each nut in a crosswise sequence. Tightening torque is 140 Nm.

10. Align the valve hole in the wheel cover with the tyre valve before installing.  
Install wheel nut caps.  
Install centre cap on alloy wheels.
  11. Stow the replaced wheel ⇨ 187 and the vehicle tools ⇨ 177.
  12. Check the tyre pressure of the installed tyre and the wheel nut torque as soon as possible.
- Have the defective tyre renewed or repaired as soon as possible.

### Jacking position for lifting platform

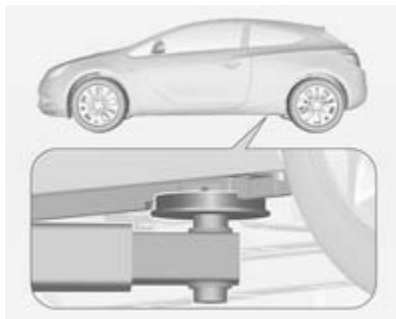

Rear arm position of the lifting platform centrally under the recess of the sill.

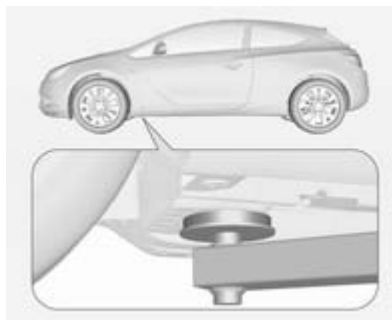

Front arm position of the lifting platform at the underbody.

### Spare wheel

Some vehicles are equipped with a tyre repair kit instead of a spare wheel.

The spare wheel can be classified as a temporary spare wheel depending on the size compared to the other mounted wheels and country regulations.

The spare wheel has a steel rim.

#### Caution

The use of a spare wheel that is smaller than the other wheels or in combination with winter tyres could affect driveability. Have the defective tyre replaced as soon as possible.



The spare wheel is located in the spare wheel well beneath the floor covering.

To remove:

1. Open the floor cover.

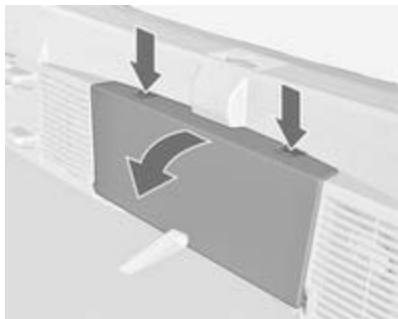

2. Remove rear storage: press both buttons and fold down cover. Extract storage upwards.
3. The spare wheel is secured with a wing nut. Untwist nut, remove conus and take out the spare wheel.  
Under the spare wheel there is the box with vehicle tools.
4. Change the damaged wheel ↗ 184.
5. Secure the tool box by turning right back the conus and the wing nut, close floor cover and insert rear storage.

The spare wheel well is not designed for other tyre sizes than spare wheel.

### Stowing a damaged wheel in the load compartment

A damaged wheel must be stowed in the load compartment and secured with a strap. Vehicle tools ↗ 177.

1. Position the wheel close to one sidewall of the load compartment.

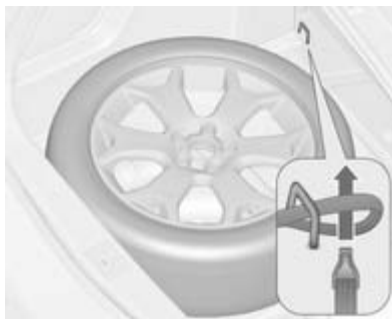

2. Place the loop end of the strap through the front lashing eye on the appropriate side.

3. Place the hook end of the strap through the loop and pull it until the strap is fastened securely to the lashing eye.



4. Insert the strap through the spokes of the wheel as shown in the illustration.
5. Mount the hook to the rear lashing eye.
6. Tighten the strap and secure it using the buckle.

## Stowing the spare wheel back in the well after replacing the damaged wheel

1. Open floor cover, remove rear storage, untwist and remove wing nut and conus.
2. Place spare wheel with outside upwards in the wheel well.

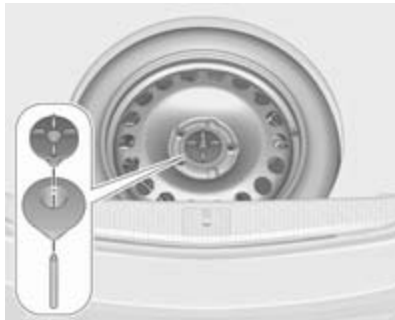

3. Position the excentric conus in the recess of the spare wheel and secure by turning the wing nut right back.
4. Close floor cover and insert rear storage.

### ⚠ Warning

Storing a jack, a wheel or other equipment in the load compartment could cause injury if they are not fixed properly. During a sudden stop or a collision, loose equipment could strike someone.

Store jack and tools always in the respective storage compartments and secure them by fixing.

Damaged wheel placed in the load compartment must always be secured by the strap.

### Temporary spare wheel

#### Caution

The use of a spare wheel that is smaller than the other wheels or in combination with winter tyres could affect driveability. Have the defective tyre replaced as soon as possible.

Only mount one temporary spare wheel. Do not drive faster than 50 mph. Take curves slowly. Do not use for a long period of time.

If your vehicle gets a flat tyre on the rear while towing another vehicle, mount the temporary spare wheel in the front and the full tyre in the rear.

Tyre chains ⇨ 181.

### Directional tyres

Fit directional tyres such that they roll in the direction of travel. The rolling direction is indicated by a symbol (e.g. an arrow) on the sidewall.

The following applies to tyres fitted opposing the rolling direction:

- Driveability may be affected. Have the defective tyre renewed or repaired as soon as possible.
- Drive particularly carefully on wet and snow-covered road surfaces.

## Jump starting

Do not start with quick charger.

A vehicle with a discharged battery can be started using jump leads and the battery of another vehicle.

### ⚠ Warning

Be extremely careful when starting with jump leads. Any deviation from the following instructions can lead to injuries or damage caused by battery explosion or damage to the electrical systems of both vehicles.

### ⚠ Warning

Avoid contact of the battery with eyes, skin, fabrics and painted surfaces. The fluid contains sulphuric acid which can cause injuries and damage in the event of direct contact.

- Never expose the battery to naked flames or sparks.

- A discharged battery can already freeze at a temperature of 0 °C. Defrost the frozen battery before connecting jump leads.
- Wear eye protection and protective clothing when handling a battery.
- Use a booster battery with the same voltage (12 Volts). Its capacity (Ah) must not be much less than that of the discharged battery.
- Use jump leads with insulated terminals and a cross section of at least 16 mm<sup>2</sup> (25 mm<sup>2</sup> for diesel engines).
- Do not disconnect the discharged battery from the vehicle.
- Switch off all unnecessary electrical consumers.
- Do not lean over the battery during jump starting.
- Do not allow the terminals of one lead to touch those of the other lead.

- The vehicles must not come into contact with each other during the jump starting process.
- Apply the parking brake, transmission in neutral, automatic transmission in **P**.

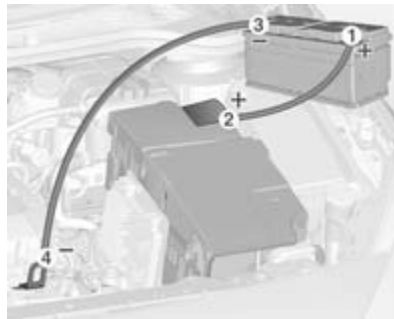

Lead connection order:

1. Connect the red lead to the positive terminal of the booster battery.
2. Connect the other end of the red lead to the positive terminal of the discharged battery.

3. Connect the black lead to the negative terminal of the booster battery.
4. Connect the other end of the black lead to a vehicle grounding point, such as the engine block or an engine mounting bolt. Connect as far away from the discharged battery as possible, however at least 60 cm.

Route the leads so that they cannot catch on rotating parts in the engine compartment.

To start the engine:

1. Start the engine of the vehicle providing the jump.
2. After 5 minutes, start the other engine. Start attempts should be made for no longer than 15 seconds at an interval of 1 minute.
3. Allow both engines to idle for approx. 3 minutes with the leads connected.

4. Switch on electrical consumers (e.g. headlights, heated rear window) of the vehicle receiving the jump start.
5. Reverse above sequence exactly when removing leads.

## Towing

### Towing the vehicle



Insert a screwdriver in the slot at the lower bend of the cap. Release the cap by carefully moving the screwdriver downwards.

The towing eye is stowed with the vehicle tools ↻ 177.





Screw in the towing eye as far as it will go until it stops in a horizontal position.

Attach a tow rope – or better still a tow rod – to the towing eye.

The towing eye must only be used for towing and not for recovering the vehicle.

Switch on ignition to release steering wheel lock and to permit operation of brake lights, horn and windscreen wiper.

Transmission in neutral.

Switch on the hazard warning flashers on both vehicles.

### Caution

Drive slowly. Do not drive jerkily. Excessive tractive force can damage the vehicle.

When the engine is not running, considerably more force is needed to brake and steer.

To prevent the entry of exhaust gases from the towing vehicle, switch on the air recirculation and close the windows.

Vehicles with automatic transmission: The vehicle must be towed facing forwards, not faster than 50 mph nor further than 60 miles. In all other cases and when the transmission is defective, the front axle must be raised off the ground.

Seek the assistance of a workshop.

After towing, unscrew the towing eye.

Insert cap at the top and engage downwards.

### Towing another vehicle



Insert a screwdriver in the slot at the lower bend of the cap. Release the cap by carefully moving the screwdriver downwards.

The towing eye is stowed with the vehicle tools ⇨ 177.



Screw in the towing eye as far as it will go until it stops in a horizontal position.

The lashing eye at the rear underneath the vehicle must never be used as a towing eye.

Attach a tow rope – or even better a tow bar – to the towing eye.

The towing eye must only be used for towing and not for recovering a vehicle.

### Caution

Drive slowly. Do not drive jerkily. Excessive tractive force can damage the vehicle.

After towing, unscrew the towing eye.

Insert cap at the top and engage downwards.

## Appearance care

### Exterior care

#### Locks

The locks are lubricated at the factory using a high quality lock cylinder grease. Use de-icing agent only when absolutely necessary, as this has a degreasing effect and impairs lock function. After using de-icing agent, have the locks regreased by a workshop.

#### Washing

The paintwork of your vehicle is exposed to environmental influences. Wash and wax your vehicle regularly. When using automatic vehicle washes, select a programme that includes waxing.

Bird droppings, dead insects, resin, pollen and the like should be cleaned off immediately, as they contain aggressive constituents which can cause paint damage.

If using a vehicle wash, comply with the vehicle wash manufacturer's instructions. The windscreen wiper and rear window wiper must be switched off. Remove antenna and external accessories such as roof racks etc.

If you wash your vehicle by hand, make sure that the insides of the wheel housings are also thoroughly rinsed out.

Clean edges and folds on opened doors and the bonnet as well as the areas they cover.

### **Caution**

Always use a cleaning agent with a pH value of 4 to 9.

Do not use cleaning agents on hot surfaces.

Have the door hinges of all doors greased by a workshop.

Do not clean the engine compartment with a steam-jet or high-pressure jet cleaner.

On vehicles with emblem touchpad: when cleaning with a high-pressure jet cleaner ensure a minimum distance of 30 cm when working around the tailgate to prevent unintended unlocking.

Thoroughly rinse and leather-off the vehicle. Rinse leather frequently. Use separate leathers for painted and glass surfaces: remnants of wax on the windows will impair vision.

### **Exterior lights**

Headlight and other light covers are made of plastic. Do not use any abrasive or caustic agents, do not use an ice scraper, and do not clean them dry.

### **Polishing and waxing**

Wax the vehicle regularly (at the latest when water no longer beads). Otherwise, the paintwork will dry out.

Polishing is necessary only if the paint has become dull or if solid deposits have become attached to it.

Paintwork polish with silicone forms a protective film, making waxing unnecessary.

Plastic body parts must not be treated with wax or polishing agents.

### **Windows and windscreen wiper blades**

Use a soft lint-free cloth or chamois leather together with window cleaner and insect remover.

When cleaning the rear window, make sure the heating element inside is not damaged.

For mechanical removal of ice, use a sharp-edged ice scraper. Press the scraper firmly against the glass so that no dirt can get under it and scratch the glass.

Clean smearing wiper blades with a soft cloth and window cleaner.

### Glass panel

Never clean with solvents or abrasive agents, fuels, aggressive media (e.g. paint cleaner, acetone-containing solutions etc.), acidic or highly alkaline media or abrasive pads. Do not apply wax or polishing agents to the glass panel.

### Wheels and tyres

Do not use high-pressure jet cleaners.

Clean rims with a pH-neutral wheel cleaner.

Rims are painted and can be treated with the same agents as the body.

### Paintwork damage

Rectify minor paintwork damage with a touch-up pen before rust forms. Have more extensive damage or rust areas repaired by a workshop.

### Underbody

Some areas of the vehicle underbody have a PVC undercoating while other critical areas have a durable protective wax coating.

After the underbody is washed, check the underbody and have it waxed if necessary.

Bitumen/rubber materials could damage the PVC coating. Have underbody work carried out by a workshop.

Before and after winter, wash the underbody and have the protective wax coating checked.

### Towing equipment

Do not clean the coupling ball bar with a steam-jet or high-pressure jet cleaner.

### Air shutter

Clean the shutter system in the front bumper to maintain correct functionality.

### Interior care

#### Interior and upholstery

Only clean the vehicle interior, including the instrument panel fascia and panelling, with a dry cloth or interior cleaner.

Clean the leather upholstery with clear water and a soft cloth. In case of heavy soiling, use leather care.

The instrument panel should only be cleaned using a soft damp cloth.

Clean fabric upholstery with a vacuum cleaner and brush. Remove stains with an upholstery cleaner.

Clean seat belts with lukewarm water or interior cleaner.

#### Caution

Close Velcro fasteners as open Velcro fasteners on clothing could damage seat upholstery.

The same applies to clothing with sharp-edged objects, like zips or belts or studded jeans.

**Plastic and rubber parts**

Plastic and rubber parts can be cleaned with the same cleaner as used to clean the body. Use interior cleaner if necessary. Do not use any other agent. Avoid solvents and petrol in particular. Do not use high-pressure jet cleaners.

## Service and maintenance

General information .....	197
Recommended fluids, lubricants and parts .....	198

### General information

#### Service information

In order to ensure economical and safe vehicle operation and to maintain the value of your vehicle, it is of vital importance that all maintenance work is carried out at the proper intervals as specified.

The detailed, up-to-date service schedule for your vehicle is available at the workshop.

Service display ⇨ 72.

#### European service intervals

Maintenance of your vehicle is required every 20000 miles or after 1 year, whichever occurs first, unless otherwise indicated in the service display.

The European service intervals are valid for the following countries:

Andorra, Austria, Belgium, Bosnia-Herzegovina, Bulgaria, Croatia, Cyprus, Czech Republic, Denmark, Estonia, Finland, France, Germany, Greece, Greenland, Hungary,

Iceland, Ireland, Israel, Italy, Latvia, Lithuania, Luxembourg, Macedonia, Malta, Montenegro, Netherlands, Norway, Poland, Portugal, Romania, Slovakia, Slovenia, Spain, Sweden, Switzerland, United Kingdom.

Service display ⇨ 72.

#### International service intervals

Maintenance of your vehicle is required every 10000 miles or after 1 year, whichever occurs first, unless otherwise indicated in the service display.

The international service intervals are valid for the countries which are not listed in the European service intervals.

Service display ⇨ 72.

#### Confirmations

Confirmation of service is recorded in the Service and Warranty Booklet.

The date and mileage is completed with the stamp and signature of the servicing workshop.

Make sure that the Service and Warranty Booklet is completed correctly as continuous proof of service is essential if any warranty or goodwill claims are to be met, and is also a benefit when selling the vehicle.

### Service interval with remaining engine oil life duration

The service interval is based on several parameters depending on usage.

The service display lets you know when to change the engine oil.

Service display ⇨ 72.

## Recommended fluids, lubricants and parts

### Recommended fluids and lubricants

Only use products that meet the recommended specifications. Damage resulting from the use of products not in line with these specifications will not be covered by the warranty.

#### Warning

Operating materials are hazardous and could be poisonous. Handle with care. Pay attention to information given on the containers.

### Engine oil

Engine oil is identified by its quality and its viscosity. Quality is more important than viscosity when selecting which engine oil to use. The oil quality ensures e.g. engine cleanliness, wear protection and oil

aging control, whereas viscosity grade gives information on the oil's thickness over a temperature range.

Dexos is the newest engine oil quality that provides optimum protection for gasoline and diesel engines. If it is unavailable, engine oils of other listed qualities have to be used. Recommendations for gasoline engines are also valid for Compressed Natural Gas (CNG), Liquefied Petroleum Gas (LPG) and Ethanol (E85) fuelled engines.

Select the appropriate engine oil based on its quality and on the minimum ambient temperature ⇨ 202.

### Topping up engine oil

Engine oils of different manufacturers and brands can be mixed as long as they comply with the required engine oil quality and viscosity.

Use of engine oil with only ACEA A1/B1 or only A5/B5 quality is prohibited, since it can cause long-term engine damage under certain operating conditions.

Select the appropriate engine oil based on its quality and on the minimum ambient temperature ↻ 202.

### **Additional engine oil additives**

The use of additional engine oil additives could cause damage and invalidate the warranty.

### **Engine oil viscosity grades**

The SAE viscosity grade gives information of the thickness of the oil.

Multigrade oil is indicated by two figures, e.g. SAE 5W-30. The first figure, followed by a W, indicates the low temperature viscosity and the second figure the high temperature viscosity.

Select the appropriate viscosity grade depending on the minimum ambient temperature ↻ 202.

All of the recommended viscosity grades are suitable for high ambient temperatures.

### **Coolant and antifreeze**

Use only organic acid type-long life coolant (LLC) antifreeze approved for the vehicle. Consult a workshop.

The system is factory filled with coolant designed for excellent corrosion protection and frost protection down to approx. -28 °C. In northern countries with very low temperatures the factory filled coolant provides frost protection down to approx. -37°C. This concentration should be maintained all year round. The use of additional coolant additives that intend to give additional corrosion protection or seal against minor leaks can cause function problems. Liability for consequences resulting from the use of additional coolant additives will be rejected.

### **Brake and clutch fluid**

Only use high-performance brake fluid approved for the vehicle, consult a workshop.

Over time, brake fluid absorbs moisture which will reduce braking effectiveness. The brake fluid should therefore be replaced at the specified interval.

Brake fluid should be stored in a sealed container to avoid water absorption.

Ensure brake fluid does not become contaminated.



## Technical data

Vehicle identification ..... 200  
Vehicle data ..... 202

## Vehicle identification

### Vehicle Identification Number



The Vehicle Identification Number is visible through the windscreen.

## Identification plate



The identification plate is located on the front left door frame.



Information on identification label:

- 1 = Manufacturer
- 2 = Type approval number
- 3 = Vehicle Identification Number
- 4 = Permissible gross vehicle weight rating in kg
- 5 = Permissible gross train weight in kg
- 6 = Maximum permissible front axle load in kg
- 7 = Maximum permissible rear axle load in kg
- 8 = Vehicle-specific or country-specific data

The combined total of front and rear axle loads must not exceed the permissible gross vehicle weight. For example, if the front axle is bearing its maximum permissible load, the rear axle can only bear a load that is equal to the gross vehicle weight minus the front axle load.

The technical data is determined in accordance with European Community standards. We reserve the right to make modifications.

Specifications in the vehicle documents always have priority over those given in this manual.

## Vehicle data

### Recommended fluids and lubricants

#### European service schedule

#### Required engine oil quality

Engine oil quality	All European countries (except Belarus, Moldova, Russia, Serbia, Turkey)		Only Israel	
	Petrol engines (including CNG, LPG, E85)	Diesel engines	Petrol engines (including CNG, LPG, E85)	Diesel engines
<b>dexos 1</b>	–	–	✓	–
<b>dexos 2</b>	✓	✓	–	✓

In case dexos quality is unavailable you may use max. 1 litre engine oil quality ACEA C3 once between each oil change.

#### Engine oil viscosity grades

All European countries and Israel (except Belarus, Moldova, Russia, Serbia, Turkey)	
Ambient temperature	Petrol and diesel engines
down to -25 °C	SAE 5W-30 or SAE 5W-40
below -25 °C	SAE 0W-30 or SAE 0W-40

## International service schedule

### Required engine oil quality

Engine oil quality	All countries outside Europe except Israel		Only Belarus, Moldova, Russia, Serbia, Turkey	
	Petrol engines (including CNG, LPG, E85)	Diesel engines	Petrol engines (including CNG, LPG, E85)	Diesel engines
<b>dexos 1</b>	✓	–	–	–
<b>dexos 2</b>	–	✓	✓	✓

In case dexos quality is unavailable you may use the oil qualities listed below:

Engine oil quality	All countries outside Europe except Israel		Only Belarus, Moldova, Russia, Serbia, Turkey	
	Petrol engines (including CNG, LPG, E85)	Diesel engines	Petrol engines (including CNG, LPG, E85)	Diesel engines
GM-LL-A-025	✓	–	✓	–
GM-LL-B-025	–	✓	–	✓

Engine oil quality	All countries outside Europe except Israel		Only Belarus, Moldova, Russia, Serbia, Turkey	
	Petrol engines (including CNG, LPG, E85)	Diesel engines	Petrol engines (including CNG, LPG, E85)	Diesel engines
ACEA A3/B3	✓	–	✓	–
ACEA A3/B4	✓	✓	✓	✓
ACEA C3	✓	✓	✓	✓
API SM	✓	–	✓	–
API SN resource conserving	✓	–	✓	–

### Engine oil viscosity grades

All countries outside Europe (except Israel), including Belarus, Moldova, Russia, Serbia, Turkey	
Ambient temperature	Petrol and diesel engines
down to -25 °C	SAE 5W-30 or SAE 5W-40
below -25 °C	SAE 0W-30 or SAE 0W-40
down to -20 °C	SAE 10W-30 <sup>1)</sup> or SAE 10W-40 <sup>1)</sup>

<sup>1)</sup> Permitted, but usage of SAE 5W-30 or SAE 5W-40 with dexos quality is recommended.

## Engine data

Sales designation	1.4	1.4	1.4
Engine identifier code	A14XER	A14NEL	A14NET
Number of cylinders	4	4	4
Piston displacement [cm <sup>3</sup> ]	1398	1362	1362
Engine power [kW]	74	88	103
at rpm	6000	4200-6000	4900-6000
Torque [Nm]	130	200	200
at rpm	4000	1850-4200	1850-4900
Fuel type	Petrol	Petrol	Petrol
Octane rating RON			
recommended	95	95	95
	Super schwefelfrei (95)	Super schwefelfrei (95)	Super schwefelfrei (95)
possible	98	98	98
	Super Plus schwefelfrei (98)	Super Plus schwefelfrei (98)	Super Plus schwefelfrei (98)
possible	91	91	91
	Benzin schwefelfrei (91)	Benzin schwefelfrei (91)	Benzin schwefelfrei (91)
Oil consumption [l/1000 km]	0.6	0.6	0.6

**206      Technical data**

---

<b>Sales designation</b>	<b>1.6</b>	<b>1.8</b>	<b>2.0 VXR</b>
<b>Engine identifier code</b>	<b>A16LET</b>	<b>A18XER</b>	<b>A20NFT</b>
Number of cylinders	4	4	4
Piston displacement [cm <sup>3</sup> ]	1598	1796	1998
Engine power [kW]	132	103	206
at rpm	5500	6300	5300
Torque [Nm]	230	175	400
at rpm	2200	3800	2400-4800
Fuel type	Petrol	Petrol	Petrol
Octane rating RON			
recommended	95	95	98
possible	98	98	95
possible	91	91	91
Oil consumption [l/1000 km]	0.6	0.6	0.6

---

Sales designation	1.7	1.7	2.0 Turbo	2.0 Turbo
Engine identifier code	A17DTC	A17DTS	A20DTJ	A20DTH
Number of cylinders	4	4	4	4
Piston displacement [cm <sup>3</sup> ]	1686	1686	1956	1956
Engine power [kW]	81	96	96	121
at rpm	4000	4000	4000	4000
Torque [Nm]	280	300	300	350
at rpm	1750- 2500	2000-2500	1750-2500	1750-2500
Fuel type	Diesel	Diesel	Diesel	Diesel
Oil consumption [l/1000 km]	0.6	0.6	0.6	0.6

## Performance

Engine	A14XER	A14NEL	A14NET	A16LET	A18XER	A20NFT
Maximum speed <sup>2)</sup> [mph]						
Manual transmission	111	119	125	137	<sup>3)</sup>	<sup>3)</sup>
Automatic transmission	–	–	124	–	–	–

<sup>2)</sup> The maximum speed indicated is achievable at kerb weight (without driver) plus 200 kg payload. Optional equipment could reduce the specified maximum speed of the vehicle.

<sup>3)</sup> Value was not available at time of printing.



## 208 Technical data

---

Engine	A17DTS	AA17DTC	AA20DTJ	A20DTH
Maximum speed <sup>4)</sup> [mph]				
Manual transmission	3)	3)	3)	131
Automatic transmission	–	–	3)	129

---

4) The maximum speed indicated is achievable at kerb weight (without driver) plus 200 kg payload. Optional equipment could reduce the specified maximum speed of the vehicle.

3) Value was not available at time of printing.

## Vehicle weight

### Kerb weight, basic model without any optional equipment

	Engine	Manual transmission	Automatic transmission
with air conditioning [kg]	A14XER	1437	–
	A14NEL	1437	–
	A14NET	1437	5)
	A16LET	1471	–
	A17DTS	5)	–
	A17DTC	5)	–
	A18XER	5)	–
	A20DTJ	5)	5)
	A20DTH	1550	5)
	A20NFT	5)	–

5) Value was not available at time of printing.

## Kerb weight, basic model with all optional equipment

	Engine	Manual transmission	Automatic transmission
with air conditioning [kg]	A14XER	1571	–
	A14NEL	1571	–
	A14NET	1571	5)
	A16LET	1613	–
	A17DTS	5)	–
	A17DTC	5)	–
	A18XER	5)	–
	A20DTJ	5)	5)
	A20DTH	1701	5)
	A20NFT	5)	–

5) Value was not available at time of printing.

---

## Vehicle dimensions

---

Length [mm]	4466
Width without exterior mirrors [mm]	1840
Width with two exterior mirrors [mm]	2020
Height (without antenna) [mm]	1482
Length of load compartment floor [mm]	855
Length of load compartment with folded rear seats [mm]	1617
Load compartment width [mm]	980
Load compartment height [mm]	512
Wheelbase [mm]	2695
Turning circle diameter [m]	11.4

---

---

## Capacities

### Engine oil

Engine	A14XER, A14NEL, A14NET	A16LET	A17DTS, A17DTC	A18XER	A20DTJ, A20DTH	A20NFT
including Filter [l]	4.0	4.5	4.0	4.5	4.5	6.0
between MIN and MAX [l]	1.0	1.0	1.0	1.0	1.0	1.0

### Fuel tank

Petrol/diesel, nominal capacity [l]	56
-------------------------------------	----

---

## Tyre pressures

Engine	Tyres	Comfort with up to 3 people		ECO with up to 3 people		With full load	
		front	rear	front	rear	front	rear
		[kPa/bar] ([psi])	[kPa/bar] ([psi])	[kPa/bar] ([psi])	[kPa/bar] ([psi])	[kPa/bar] ([psi])	[kPa/bar] ([psi])
A14XER, A18XER	225/55 R17, 235/50 R18, 235/55 R17, 245/45 R18, 235/45 R19	210/2.1 (30)	210/2.1 (30)	250/2.5 (36)	250/2.5 (36)	220/2.2 (32)	260/2.6 (38)
A14NEL, A14NET	225/55 R17, 235/45 R19, 235/50 R18, 235/55 R17, 245/40 R20, 245/45 R18	210/2.1 (30)	210/2.1 (30)	270/2.7 (39)	270/2.7 (39)	220/2.2 (32)	270/2.7 (39)

Engine	Tyres	Comfort with up to 3 people		ECO with up to 3 people		With full load	
		front	rear	front	rear	front	rear
		[kPa/bar] ([psi])	[kPa/bar] ([psi])	[kPa/bar] ([psi])	[kPa/bar] ([psi])	[kPa/bar] ([psi])	[kPa/bar] ([psi])
A16LET	225/55 R17, 235/45 R19, 235/50 R18, 235/55 R17, 245/40 R20, 245/45 R18	210/2.1 (30)	210/2.1 (30)	250/2.5 (36)	250/2.5 (36)	220/2.2 (32)	260/2.6 (38)
A17DTS, A17DTC	225/55 R17, 235/45 R19, 235/50 R18, 235/55 R17, 245/40 R20, 245/45 R18	210/2.1 (30)	210/2.1 (30)	250/2.5 (36)	250/2.5 (36)	220/2.2 (32)	260/2.6 (38)

Engine	Tyres	Comfort with up to 3 people		ECO with up to 3 people		With full load	
		front	rear	front	rear	front	rear
		[kPa/bar] ([psi])	[kPa/bar] ([psi])	[kPa/bar] ([psi])	[kPa/bar] ([psi])	[kPa/bar] ([psi])	[kPa/bar] ([psi])
A20DTJ,	225/55 R17,	230/2.3 (33)	230/2.3 (33)	270/2.7 (39)	270/2.7 (39)	240/2.4 (35)	280/2.8 (41)
A20DTH	235/45 R19, 235/50 R18, 235/55 R17, 245/40 R20, 245/45 R18						
A20NFT	245/40 R19,	240/2.4 (35)	240/2.4 (35)	–	–	260/2.6 (38)	300/3.0 (43)
	245/35 R20,	270/2.7 (39)	250/2.5 (36)	–	–	280/2.8 (41)	310/3.1 (44)
	235/45 R18	240/2.4 (35)	240/2.4 (35)	–	–	260/2.6 (38)	300/3.0 (43)
All	Temporary spare wheel	420/4.2 (61)	420/4.2 (61)	–	–	420/4.2 (61)	420/4.2 (61)



## Towing hitch installation dimensions

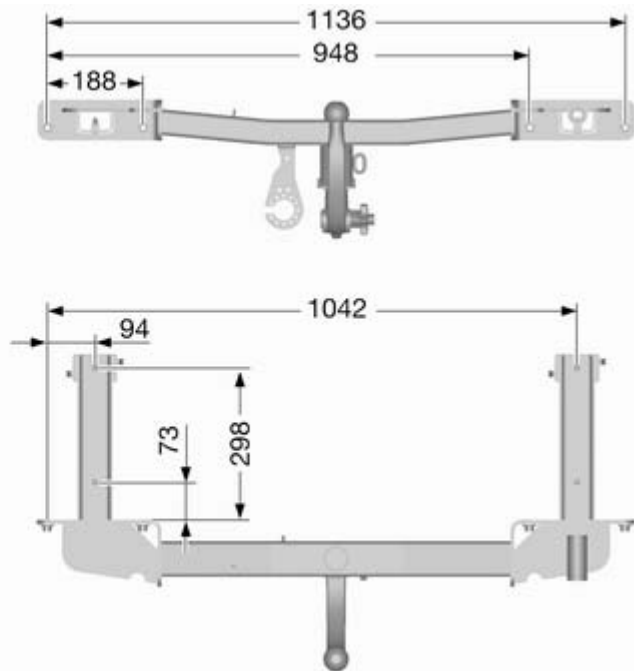
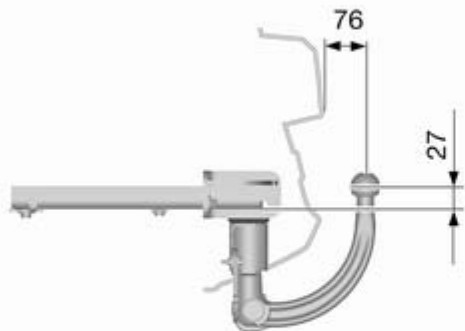

## Customer information

Vehicle data recording and  
privacy ..... 217

### Vehicle data recording and privacy

#### Event data recorders

The vehicle has a number of sophisticated systems that monitor and control several vehicle data. Some data may be stored during regular operation to facilitate repair of detected malfunctions, other data is stored only in a crash or near crash event by modules in your vehicle systems that have an event data recording function such as the airbag control module.

The systems may record diagnostic data about the condition of the vehicle (e.g. oil level or vehicle mileage) and information how it was operated (e.g. engine speed, brake application and seat belt usage).

To read this data, special equipment and access to the vehicle is required. Some diagnostic data is electronically fed into Vauxhall global systems when the vehicle is serviced in a workshop, in order to document the

service history of the vehicle. This enables the workshop to offer you efficient maintenance and repair, tailored to your individual vehicle, each time you bring it back to the workshop.

The manufacturer will not access driver's behaviour related information about a crash event or share it with others except:

- with the consent of the vehicle owner or, if the vehicle is leased, of the lessee
- in response to an official request of police or similar government office
- as part of the manufacturer's defense in case of legal proceedings
- as required by law

In addition, the manufacturer may use the collected or received diagnostic data:

- for the manufacturer's research needs
- to make it available for research needs where appropriate confidentiality is maintained and need is shown
- to share summary data which is not tied to a specific vehicle with other organisations for research purposes

## **Radio Frequency Identification (RFID)**

RFID technology is used in some vehicles for functions such as tyre pressure monitoring and ignition system security. It is also used in connection with conveniences such as radio remote controls for door locking/unlocking and starting, and in-vehicle transmitters for garage door openers. RFID technology in Vauxhall vehicles does not use or record personal information or link with any other Vauxhall system containing personal information.



# Index

## A

Accessories and vehicle modifications .....	155
Active head restraints.....	34
Adaptive forward lighting .....	80, 102, 165
Adjustable air vents .....	118
Airbag and belt tensioners .....	75
Airbag deactivation .....	44, 75
Airbag system .....	42
Air conditioning regular operation .....	119
Air conditioning system .....	113
Air intake .....	119
Air vents.....	118
Antilock brake system .....	131
Antilock brake system (ABS) .....	77
Anti-theft alarm system .....	25
Anti-theft locking system .....	25
Appearance care.....	193
Armrest.....	39
Armrest storage .....	54
Ashtrays .....	69
Automatic anti-dazzle .....	29
Automatic light control .....	100
Automatic locking .....	23
Automatic transmission .....	127
Auxiliary heater.....	118

## B

Battery .....	160
Battery discharge protection .....	110
Battery voltage .....	90
Bonnet .....	156
Brake and clutch fluid.....	198
Brake and clutch system .....	76
Brake assist .....	133
Brake fluid .....	159
Brakes .....	131, 159
Breakdown.....	191
Bulb replacement .....	163

## C

Capacities .....	212
Car Pass .....	19
Catalytic converter .....	126
Central locking system .....	21
Centre console lighting .....	109
Centre console storage .....	54
Changing tyre and wheel size ...	181
Charging system .....	76
Child restraint installation locations .....	48
Child restraint systems .....	46
Cigarette lighter .....	69
Climate control .....	15
Climate control systems.....	112
Clock.....	68

Code.....	86	Electronic climate control system .....	114	Fog lights .....	167
Control indicators.....	72	Electronic driving programmes ..	129	Folding .....	28
Control of the vehicle .....	120	Electronic Stability Control.....	134	Following distance indication.....	140
Controls.....	63	Electronic Stability Control and Traction Control system.....	78	Front airbag system .....	42
Convex shape .....	27	Electronic Stability Control off.....	78	Front fog lights .....	106
Coolant and antifreeze.....	198	End-of-life vehicle recovery .....	156	Front seats.....	35
Cruise control .....	80, 138	Engine compartment fuse box ...	172	Front storage.....	53
Cupholders .....	52	Engine coolant .....	158	Fuel.....	147
Curtain airbag system .....	44	Engine coolant temperature gauge .....	71	Fuel consumption - CO <sub>2</sub> - Emissions .....	149
Curve lighting.....	102	Engine data .....	205	Fuel for diesel engines .....	148
<b>D</b>		Engine exhaust .....	125	Fuel for petrol engines .....	147
Danger, Warnings and Cautions ...	3	Engine oil .....	157, 198, 202	Fuel gauge .....	71
Diesel fuel system bleeding .....	162	Engine oil pressure .....	79	Fuses .....	171
Diesel particle filter.....	78, 125	Entry lighting .....	109	<b>G</b>	
Door open .....	81	Event data recorders.....	217	Gauges.....	70
Doors.....	23	Exit lighting .....	110	General information .....	150
Driver assistance systems.....	138	Exterior care .....	193	Glass panel .....	32
Driver Information Centre.....	81	Exterior light .....	80	Glovebox .....	52
Driving characteristics and towing tips .....	150	Exterior lighting .....	12, 99	Graphic-Info-Display, Colour- Info-Display .....	84
Driving hints.....	120	Exterior mirrors.....	27	<b>H</b>	
<b>E</b>		<b>F</b>		Halogen headlights .....	163
ECO drive assistant.....	90	Fault .....	129	Hand brake.....	131, 132
Electric adjustment .....	27	First aid.....	61	Hazard warning flashers .....	106
Electrical parking brake.....	77	First aid kit .....	61	Headlight flash .....	101
Electrical parking brake fault.....	77	Fixed air vents .....	118	Headlight range adjustment .....	101
Electrical system.....	171	Fog light .....	80	Headlights.....	99

Headlights when driving abroad	102	Interior mirrors.....	29	Memorised settings.....	21
Head restraint adjustment .....	8	Interruption of power supply .....	129	Mirror adjustment .....	9
Head restraints .....	33	Introduction .....	3	Misted light covers .....	107
Heated .....	28	ISOFIX child restraint systems .....	51	<b>N</b>	
Heated rear window .....	31	<b>J</b>		New vehicle running-in .....	121
Heated steering wheel .....	64	Jump starting .....	190	Number plate light .....	170
Heating .....	39	<b>K</b>		<b>O</b>	
Heating and ventilation system .	112	Key, memorised settings.....	21	Object detection systems.....	141
Height adjustable rear floor cover	58	Keys .....	19	Odometer .....	70
High beam .....	80, 100	Keys, locks.....	19	Oil, engine.....	198, 202
High beam assist.....	80, 100	<b>L</b>		Outside temperature .....	67
Hill start assist .....	133	Lane departure warning.....	78, 146	Overrun cut-off .....	122
Horn .....	13, 64	Lashing eyes .....	60	<b>P</b>	
<b>I</b>		Lighting features.....	109	Parking .....	17, 125
Identification plate .....	200	Light switch .....	99	Parking assist .....	141
Ignition switch positions .....	121	Load compartment .....	23, 55	Parking brake .....	132
Immobiliser .....	27, 80	Load compartment cover .....	57	Parking lights .....	107
Indicators.....	70	Load compartment fuse box .....	175	Particulate filter.....	125
Information displays.....	81	Loading information .....	61	Performance .....	207
Instrument cluster .....	70	Low fuel .....	79	Performing work .....	156
Instrument panel fuse box .....	174	Low washer fluid .....	80	Pollen filter .....	119
Instrument panel illumination .....	170	<b>M</b>		Power outlets .....	69
Instrument panel illumination		Malfunction indicator light .....	76	Power steering.....	77
control .....	108	Manual anti-dazzle .....	29	Power windows .....	30
Instrument panel overview .....	10	Manual mode .....	128	Preheating .....	78
Interactive driving system.....	135	Manual transmission .....	130	Puncture.....	184
Interior care .....	195				
Interior lighting.....	108				
Interior lights .....	108, 170				

<b>Q</b>			
Quickheat.....	118		
<b>R</b>			
Radio Frequency Identification (RFID).....	218		
Radio remote control .....	20		
Reading lights .....	109		
Rear floor storage cover .....	58		
Rear fog light .....	80		
Rear fog lights .....	107		
Rear seats.....	39		
Rear storage.....	57		
Rear window wiper/washer .....	67		
Recommended fluids and lubricants .....	198, 202		
Reduced engine power.....	80		
Refuelling .....	148		
Retained power off.....	121		
Reversing lights .....	107		
Ride control systems.....	134		
Roof rack .....	61		
<b>S</b>			
Seat adjustment .....	7, 35		
Seat belt .....	8		
Seat belt reminder .....	75		
Seat belts .....	40		
Seat folding .....	38		
Seat position .....	35		
		Selector lever .....	127
		Service .....	119, 197
		Service display .....	72
		Service information .....	197
		Service vehicle soon .....	76
		Side airbag system .....	43
		Sidelights.....	99
		Side turn signal lights .....	170
		Smartphone controller.....	86
		Spare wheel .....	187
		Speed limiter.....	139
		Speedometer .....	70
		Starting and operating.....	121
		Starting off .....	16
		Starting the engine .....	121
		Steering wheel adjustment .....	9, 63
		Steering wheel controls .....	63
		Stop-start system.....	123
		Storage.....	52
		Storage compartments.....	52
		Sunglasses storage .....	53
		Sunvisor lights .....	109
		Sun visors .....	31
		Symbols .....	4
		<b>T</b>	
		Tachometer .....	71
		Tail lights .....	168
		Three-point seat belt .....	41
		Tools .....	177
		Top-tether fastening eyes .....	51
		Towing.....	150, 191
		Towing another vehicle .....	192
		Towing equipment .....	151
		Towing hitch installation dimensions .....	216
		Towing the vehicle .....	191
		Traction Control system .....	134
		Traction Control system off.....	78
		Traffic sign assistant.....	143
		Trailer coupling.....	150
		Trailer stability assist .....	154
		Trailer towing .....	151
		Transmission .....	16
		Transmission display .....	127
		Tread depth .....	180
		Trip computer .....	90
		Trip odometer .....	70
		Turn and lane-change signals ...	106
		Turn signal .....	75
		Tyre chains .....	181
		Tyre designations .....	178
		Tyre pressure .....	178
		Tyre pressure monitoring system.....	79, 178
		Tyre pressures .....	213
		Tyre repair kit .....	182



**U**

Ultrasonic parking assist .....	78, 141
Upshift.....	77
Using this manual .....	3

**V**

Vehicle checks.....	156
Vehicle data.....	202
Vehicle data recording and privacy.....	217
Vehicle dimensions .....	211
Vehicle Identification Number ...	200
Vehicle jack.....	177
Vehicle messages .....	86
Vehicle personalisation .....	93
Vehicle security.....	25
Vehicle specific data .....	3
Vehicle storage.....	155
Vehicle tools.....	177
Vehicle unlocking .....	6
Vehicle weight .....	209
Ventilation.....	112

**W**

Warning chimes .....	89
Warning lights.....	70
Warning triangle .....	60
Washer and wiper systems .....	14
Washer fluid .....	159
Wheel changing .....	184

Wheel covers .....	181
Wheels and tyres .....	177
Windows.....	29
Windscreen.....	29
Windscreen wiper/washer .....	65
Winter tyres .....	177
Wiper blade replacement .....	162