





---

# Contents

Introduction .....	2
In brief .....	6
Keys, doors and windows .....	19
Seats, restraints .....	34
Storage .....	57
Instruments and controls .....	77
Lighting .....	108
Climate control .....	117
Driving and operating .....	125
Vehicle care .....	150
Service and maintenance .....	191
Technical data .....	194
Customer information .....	209
Index .....	212

## Introduction

Fuel	Designation	<input type="text"/>		
Engine oil	Grade	<input type="text"/>		
	Viscosity	<input type="text"/>		
Tyre pressure		Tyre size	Front	Rear
	Summer tyres	<input type="text"/>	<input type="text"/>	<input type="text"/>
	Winter tyres	<input type="text"/>	<input type="text"/>	<input type="text"/>
Weights	Gross vehicle weight rating	<input type="text"/>		
	- Kerb weight, basic model	<input type="text"/>		
	= Loading	<input type="text"/>		

## Vehicle specific data

Please enter your vehicle's data on the previous page to keep it easily accessible. This information is available in the sections "Service and maintenance" and "Technical data" as well as on the identification plate.

## Introduction

Your vehicle is a designed combination of advanced technology, safety, environmental friendliness and economy.

This Owner's Manual provides you with all the necessary information to enable you to drive your vehicle safely and efficiently.

Make sure your passengers are aware of the possible risk of accident and injury which may result from improper use of the vehicle.

You must always comply with the specific laws and regulations of the country that you are in. These laws may differ from the information in this Owner's Manual.

When this Owner's Manual refers to a workshop visit, we recommend your Vauxhall Authorised Repairer.

All Vauxhall Authorised Repairers provide first-class service at reasonable prices. Experienced mechanics trained by Vauxhall work according to specific Vauxhall instructions.

The customer literature pack should always be kept ready to hand in the vehicle.

## Using this manual

- This manual describes all options and features available for this model. **Certain descriptions, including those for display and menu functions, may not apply to your vehicle due to model variant, country specifications, special equipment or accessories.**
- The "In brief" section will give you an initial overview.
- The table of contents at the beginning of this manual and within each section shows where the information is located.

- The index will enable you to search for specific information.
- This Owner's Manual depicts left-hand drive vehicles. Operation is similar for right-hand drive vehicles.
- The Owner's Manual uses the factory engine designations. The corresponding sales designations can be found in the section "Technical data".
- Directional data, e.g. left or right, or front or back, always relate to the direction of travel.
- The vehicle display screens may not support your specific language.
- Display messages and interior labelling are written in **bold** letters.

## Danger, Warnings and Cautions

### Danger

Text marked  **Danger** provides information on risk of fatal injury. Disregarding this information may endanger life.

**⚠ Warning**

Text marked **⚠ Warning** provides information on risk of accident or injury. Disregarding this information may lead to injury.

**Caution**

Text marked **Caution** provides information on possible damage to the vehicle. Disregarding this information may lead to vehicle damage.

**Symbols**

Page references are indicated with ⇨.  
⇨ means "see page".

Thank you for choosing a Vauxhall.

We wish you many hours of  
pleasurable driving.

**Your Vauxhall Team**



## In brief

## Initial drive information

### Vehicle unlocking



Press button  to unlock the doors and load compartment. Open the doors by pulling the handles. To open the tailgate, push the touchpad switch under the tailgate moulding.

Radio remote control ⇨ 20, Central locking system ⇨ 21, Load compartment ⇨ 25.

### Seat adjustment

#### Seat positioning

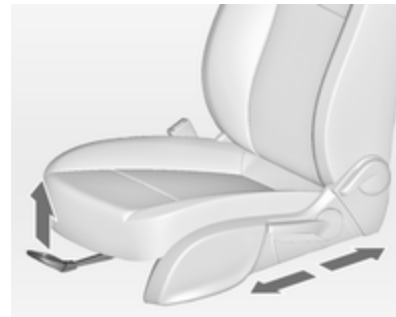

Pull handle, slide seat, release handle.

Seat position ⇨ 36, Seat adjustment ⇨ 36.

#### Danger

Do not sit nearer than 25 cm from the steering wheel, to permit safe airbag deployment.



### Seat backrests

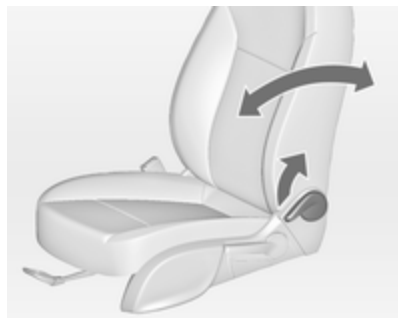

Pull lever, adjust inclination and release lever. Allow the seat to engage audibly.

Seat position ⇨ 36, Seat adjustment ⇨ 36.

### Seat height

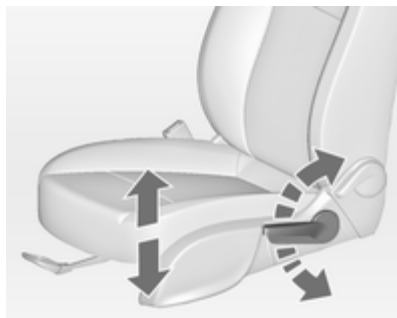

Lever pumping motion

up = seat higher  
down = seat lower

Seat position ⇨ 36, Seat adjustment ⇨ 36.

### Seat inclination

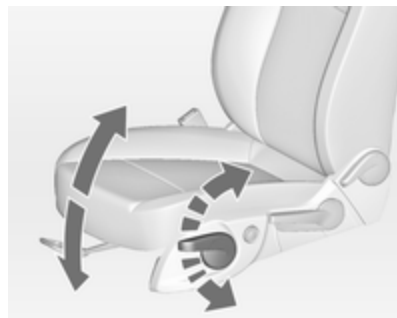

Lever pumping motion

up = front end higher  
down = front end lower

Seat position ⇨ 36, Seat adjustment ⇨ 36.

## Head restraint adjustment

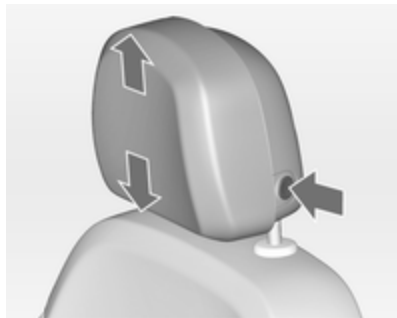

Press the button, adjust height and engage.

To adjust horizontally, pull the head restraint forwards. It engages in several positions. To return to its rearmost position, pull fully forwards and release.

Head restraints ⇨ 34.

## Seat belt



Pull out the seat belt and engage in belt buckle. The seat belt must not be twisted and must fit close against the body. The backrest must not be tilted back too far (maximum approx. 25°).

To release belt, press red button on belt buckle.

Seat position ⇨ 36, Seat belts ⇨ 43, Airbag system ⇨ 46.

## Mirror adjustment

### Interior mirror

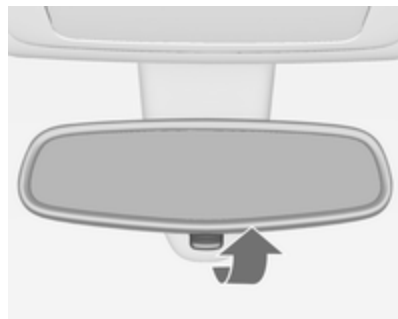

To reduce dazzle, adjust the lever on the underside of the mirror housing.

Interior mirror ⇨ 29, Automatic anti-dazzle interior mirror ⇨ 30.

## Exterior mirrors



Select the relevant exterior mirror and adjust it.

Convex exterior mirrors ⇨ 28,  
Electric adjustment ⇨ 28, Folding  
exterior mirrors ⇨ 29, Heated  
exterior mirrors ⇨ 29.

## Steering wheel adjustment



Unlock the lever, adjust the steering wheel, then engage the lever and ensure it is fully locked.

Do not adjust the steering wheel unless the vehicle is stationary and the steering wheel lock has been released.

Airbag system ⇨ 46, Ignition  
positions ⇨ 126.

## Instrument panel overview

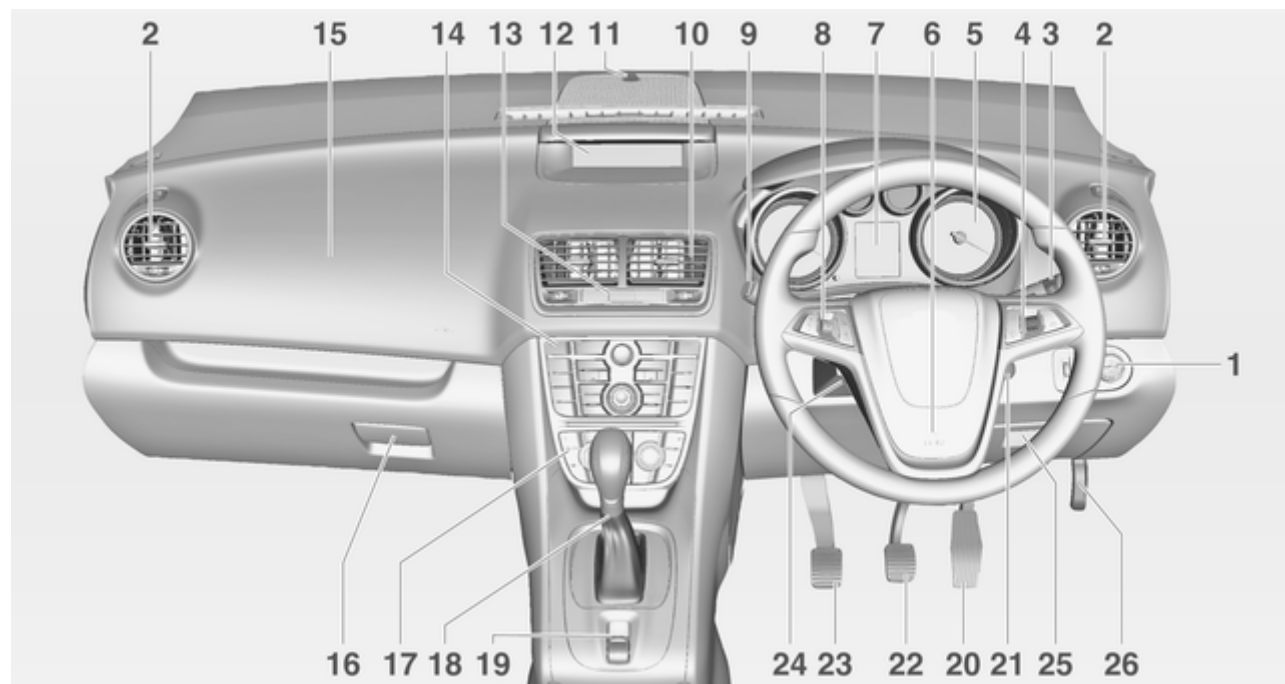

- |   |   |   |
|---|---|---|
| <p><b>1</b> Light switch ..... 108</p> <p>Headlight range<br/>adjustment ..... 109</p> <p>Front fog lights ..... 112</p> <p>Rear fog light ..... 112</p> <p>Instrument illumination ..... 113</p> <p><b>2</b> Side air vents ..... 123</p> <p><b>3</b> Turn and lane-change<br/>signals, headlight flash,<br/>low beam and high beam ... 112</p> <p>Exit lighting ..... 115</p> <p>Parking lights ..... 113</p> <p>Driver Information Centre ..... 94</p> <p><b>4</b> Cruise control ..... 140</p> <p><b>5</b> Instruments ..... 84</p> <p><b>6</b> Horn ..... 78</p> <p>Driver airbag ..... 47</p> <p><b>7</b> Driver Information Centre ..... 94</p> <p><b>8</b> Steering wheel controls ..... 77</p> | <p><b>9</b> Windscreen wiper,<br/>windscreen washer<br/>system, rear wiper, rear<br/>washer system ..... 79</p> <p><b>10</b> Centre air vents ..... 123</p> <p><b>11</b> Sensor for electronic<br/>climate control system ..... 119</p> <p><b>12</b> Info-Display ..... 96</p> <p><b>13</b> Central locking system ..... 21</p> <p>Hazard warning flashers .... 111</p> <p>Control indicator for airbag<br/>deactivation ..... 89</p> <p><b>14</b> Traction Control system .... 138</p> <p>Electronic Stability Control . 139</p> <p>Deflation detection system . 174</p> <p>Ultrasonic parking assist .... 141</p> <p>Eco button ..... 128</p> <p><b>15</b> Front passenger airbag ..... 47</p> <p><b>16</b> Glovebox ..... 57</p> <p>Fuse box ..... 170</p> <p><b>17</b> Climate control system ..... 117</p> | <p><b>18</b> Selector lever, manual<br/>transmission ..... 135</p> <p>Automatic transmission ..... 132</p> <p><b>19</b> Electrical parking brake ..... 137</p> <p><b>20</b> Accelerator pedal ..... 126</p> <p><b>21</b> Ignition switch with<br/>steering wheel lock ..... 126</p> <p><b>22</b> Brake pedal ..... 136</p> <p><b>23</b> Clutch pedal ..... 125</p> <p><b>24</b> Steering wheel adjustment . . 77</p> <p><b>25</b> Storage compartment ..... 170</p> <p><b>26</b> Bonnet release lever ..... 151</p> |
|---|---|---|

## Exterior lighting



Turn light switch

- Auto** = Automatic light control:  
Headlights are switched on  
and off automatically
- ⊕ = activation or deactivation of  
the automatic light control
- ⊕⊖ = sidelights
- ⊕⊖⊕ = headlights

Vehicles without automatic light  
control:

**O** = off

Press light switch

⊕D = front fog lights

⊖⊕ = rear fog light

Lighting ⇨ 108.

## Headlight flash, high beam and low beam

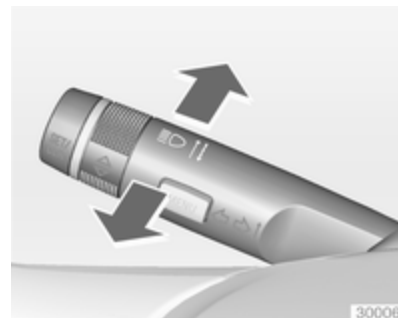

- headlight flash = pull lever
- high beam = push lever
- low beam = push or pull lever

Automatic light control ⇨ 109, High  
beam ⇨ 109, Headlight flash ⇨ 109.

## Turn and lane-change signals

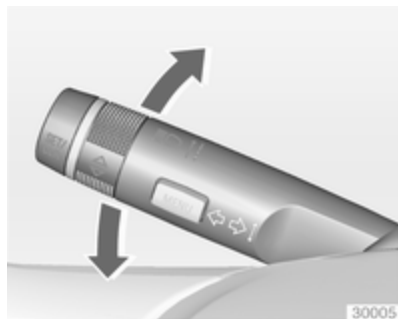

lever up = right turn signal  
lever down = left turn signal

Turn and lane-change signals  
⇨ 112, Parking lights ⇨ 113.

## Hazard warning flashers



Operated with the  button.  
Hazard warning flashers ⇨ 111.

## Horn



Press .

## Washer and wiper systems

### Windscreen wiper



- 2** = fast
- 1** = slow
-  = interval wiping or automatic wiping with rain sensor
- O** = off

For a single wipe when the windscreen wiper is off, press the lever down.

Windscreen wiper ⇨ 79, Wiper blade replacement ⇨ 157.

### Windscreen washer system

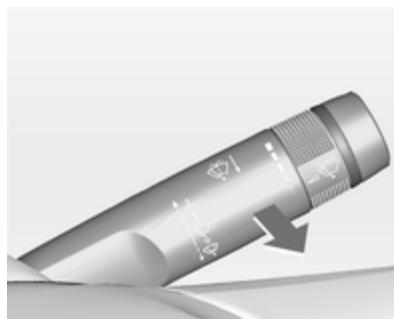

Pull lever.

Windscreen washer system ⇨ 79,  
Washer fluid ⇨ 154.

### Rear window wiper and washer systems

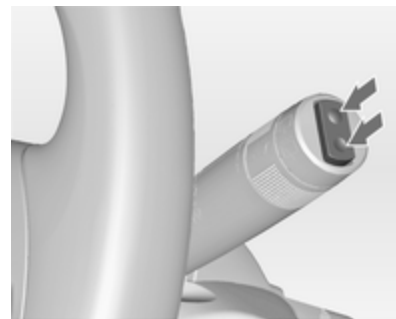

Press the rocker switch to activate the rear window wiper:

- upper position = short interval
- lower position = long interval
- middle position = off



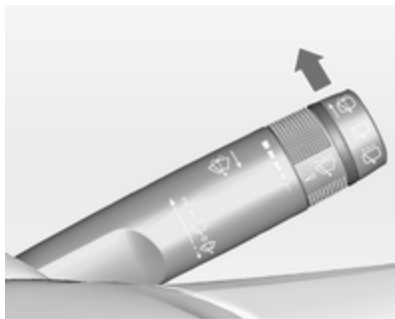

Push lever.

Washer fluid is sprayed on the rear window and the wiper wipes a few times.

Rear window wiper/washer ⇨ 80.

## Climate control

### Heated rear window, heated exterior mirrors



The heating is operated by pressing the  button.

Heated rear window ⇨ 32.

### Demisting and defrosting the windows



Press button .

Set the temperature control to the highest level.

Cooling  on.

Heated rear window  on.

Climate control system ⇨ 117.

## Transmission

### Manual transmission

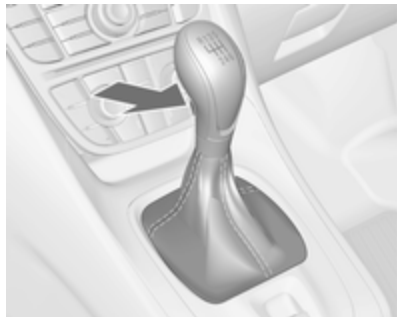

Reverse: with the vehicle stationary, depress the clutch pedal, press the release button on the selector lever and engage the gear.

If the gear does not engage, set the lever to neutral, release the clutch pedal and depress again; then repeat gear selection.

Manual transmission ⇨ 135.

### Automatic transmission



**P** = park  
**R** = reverse  
**N** = neutral  
**D** = drive

Manual mode: move selector lever from **D** to the left.

**+** = higher gear  
**-** = lower gear

The selector lever can only be moved out of **P** when the ignition is on and the brake pedal is applied. To engage **P** or **R**, press the release button.

Automatic transmission ⇨ 132.

## Starting off

### Check before starting off

- Tyre pressure and condition ⇨ 173, ⇨ 205.
- Engine oil level and fluid levels ⇨ 152.
- All windows, mirrors, exterior lighting and number plates are free from dirt, snow and ice and are operational.
- Proper position of mirrors, seats, and seat belts ⇨ 28, ⇨ 36, ⇨ 44.
- Brake function at low speed, particularly if the brakes are wet.

## Starting the engine

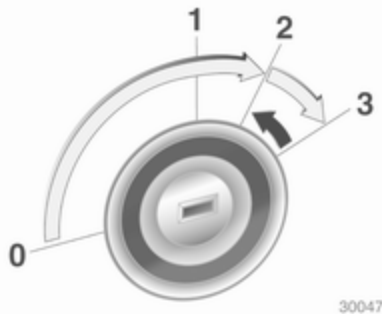

30047

- Turn key to position **1**
  - move the steering wheel slightly to release the steering wheel lock
  - operate clutch and brake
  - automatic transmission in **P** or **N**
  - do not operate accelerator pedal
  - diesel engines: turn the key to position **2** for preheating and wait until control indicator  goes out
  - turn key to position **3** and release
- Starting the engine ⇨ 126.

## Stop-start system



If the vehicle is at a low speed or at a standstill and certain conditions are fulfilled, activate an Autostop as follows:

- Depress the clutch pedal
- set the lever in neutral
- release the clutch pedal

An Autostop is indicated by the needle at the **AUTOSTOP** position in the tachometer.

To restart the engine, depress the clutch pedal again.

Stop-start system ⇨ 128.

## Parking

- Always apply the parking brake. Pull switch .
- Switch off the engine. Turn the ignition key to position **0** and remove it. Turn the steering wheel until the steering wheel lock is felt to engage.
 

For vehicles with automatic transmission, the key can only be removed when the selector lever is in the **P** position.
- If the vehicle is on a level surface or uphill slope, engage first gear or set the selector lever to **P** before switching off the ignition. On an uphill slope, turn the front wheels away from the kerb.
 

If the vehicle is on a downhill slope, engage reverse gear or set the selector lever to **P** before switching off the ignition. Turn the front wheels towards the kerb.
- Lock the vehicle with button  on the radio remote control.

Activate the anti-theft alarm system  
⇨ 27.

- Do not park the vehicle on an easily ignitable surface. The high temperature of the exhaust system could ignite the surface.
- Close the windows.
- The engine cooling fans may run after the engine has been switched off ⇨ 151.
- After running at high engine speeds or with high engine loads, operate the engine briefly at a low load or run in neutral for approx. 30 seconds before switching off, in order to protect the turbocharger.

Keys, locks ⇨ 19, Laying the vehicle up for a long period of time ⇨ 150.

## Keys, doors and windows

Keys, locks .....	19
Doors .....	25
Vehicle security .....	26
Exterior mirrors .....	28
Interior mirrors .....	29
Windows .....	30
Roof .....	33

## Keys, locks

### Keys

#### Replacement keys

The key number is specified in the Car Pass or on a detachable tag.

The key number must be quoted when ordering replacement keys as it is a component of the immobiliser system.

Locks ⇨ 188.

#### Lock cylinders

Designed to free-wheel if they are forcefully rotated without the correct key or if the correct key is not fully inserted. To reset, turn cylinder with the correct key until its slot is vertical, remove key and then re-insert it. If the cylinder still free-wheels, turn the key through 180° and repeat operation.

### Key with foldaway key section



Press button to extend. To fold the key, first press the button.

### Car Pass

The Car Pass contains security related vehicle data and should therefore be kept in a safe place.

When the vehicle is taken to a workshop, this vehicle data is needed in order to perform certain operations.

## Radio remote control



Used to operate:

- Central locking system
- Anti-theft locking system
- Anti-theft alarm system
- Power windows

The radio remote control has an approximate range of up to 5 metres. It can be restricted by external influences. The hazard warning flashers confirm operation.

Handle with care, protect from moisture and high temperatures and avoid unnecessary operation.

## Fault

If the central locking system cannot be operated with the radio remote control, it may be due to the following:

- Range exceeded
- Battery voltage too low
- Frequent, repeated operation of the radio remote control while not in range, which will require re-synchronisation
- Overload of the central locking system by operating at frequent intervals, the power supply is interrupted for a short time
- Interference from higher-power radio waves from other sources

Unlocking ⇨ 21.

## Basic settings

Some settings can be changed in the menu **Settings** in the Info-Display. Vehicle personalisation ⇨ 103.

## Radio remote control battery replacement

Replace the battery as soon as the range reduces.



Batteries do not belong in household waste. They must be disposed of at an appropriate recycling collection point.

## Key with foldaway key section

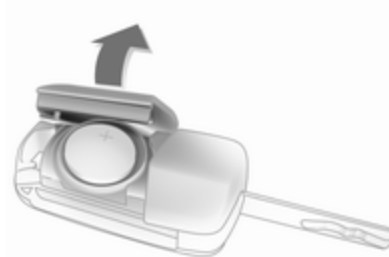

Extend the key and open the unit. Replace the battery (battery type CR 2032), paying attention to the installation position. Close the unit and synchronise.

### Key with fixed key section

Have the battery replaced by a workshop.

### Radio remote control synchronisation

After replacing the battery, unlock the door with the key in the driver's door lock. The radio remote control will be synchronised when the ignition is switched on.

### Memorised settings

Whenever the key is removed from the ignition switch, the following settings are automatically memorised by the key:

- Lighting
- Infotainment system (only CD 400)
- Central locking system
- Comfort settings

The saved settings are automatically used the next time the memorised key is inserted into the ignition switch and turned to position 1 ↷ 126.

A precondition is that **Personalization by driver** is activated in the personal settings of the Graphic-Info-Display. This must be set for each key used. On vehicles equipped with Colour-Info-Display, the personalisation is permanently activated.

Vehicle personalisation ↷ 103.

### Central locking system

Unlocks and locks doors, load compartment and fuel filler flap.

A pull on an interior door handle unlocks the respective door. Pulling the handle once more opens the door.

#### Notice



In the event of an accident in which airbags or belt pretensioners are deployed, the vehicle is automatically unlocked.

### Unlocking



Press button .

Two settings are selectable:

- To unlock only the driver's door and the fuel filler flap, press button  once. To unlock all doors and the load compartment, press button  twice,  
or
- press button  once to unlock all doors, load compartment and fuel filler flap.

The setting can be changed in the menu **Settings** in the Info-Display. Vehicle personalisation ⇨ 103.

The setting can be saved for the key being used.

Memorised settings ⇨ 21.

## Locking

Close doors, load compartment and fuel filler flap.



Press button .

If the driver's door is not closed properly, the central locking system will not work.

## Unlocking and opening the tailgate



Press button  when the ignition is off to unlock all doors. The tailgate is released and is unlocked and opened by pushing the touchpad switch under the tailgate moulding.

## Central locking button

Locks or unlocks all doors, the load compartment and fuel filler flap from the passenger compartment.



Press central locking button: the doors are locked or unlocked. If the doors are locked the LED in the button illuminates.

After locking with the radio remote control the LED in the button illuminates for approx. 2 minutes.



## Fault in radio remote control system

### Unlocking



Manually unlock the driver's door by turning the key in the lock. Switch on the ignition and press the central locking button to unlock all doors, load compartment and fuel filler flap. By switching on the ignition, the anti-theft locking system is deactivated ↻ 27.

### Locking

Close the driver's door, open the passenger door, press central locking button. The vehicle is locked. Close the passenger door.

## Fault in central locking system

### Unlocking

Manually unlock the driver's door by turning the key in the lock. The other doors can be opened by pulling the interior handle twice. The load compartment and fuel filler flap cannot be opened. To deactivate the anti-theft locking system, switch on the ignition ↻ 27.

### Locking



Insert key into the opening above the lock on inside of the door and operate the lock by pressing until it clicks. Then close the door. The procedure must be carried out for each door. The driver's door can also be locked from the outside with the key. The fuel filler flap and the tailgate cannot be locked.

## Automatic locking

### Automatic locking after driving off

The vehicle is locked automatically when exceeding a speed of 2 mph. Opening from outside is not possible. Additionally, opening of the rear doors from inside is not possible when the vehicle speed is above 2 mph.



Green LEDs indicate that opening from inside is possible:

Grasp the inner rear door handle to activate the proximity sensor and pull the handle.

When the vehicle speed is below 2 mph, opening of the doors from outside is possible after:

- opening any door from inside
- pressing the central locking button



### Caution

Automatic locking is only active with ignition on.

### Fault in the automatic locking system

In case of a system fault  illuminates in the instrument cluster and a warning chime sounds to indicate that the rear doors are not secured against opening. Inform passengers to keep clear of the door handles.

Stop immediately and activate the child lock in both rear doors. If the child lock is already activated, first deactivate and then activate again. The green LEDs will go out and the

warning chime will stop as soon as both child locks are activated. Pull the inner rear door handles to check if the doors are locked from inside. Consult a workshop.

### Automatic relock after unlocking

A short time after unlocking with the remote control, all doors, load compartment and fuel filler flap are locked automatically provided no door has been opened.

## Child locks



**⚠ Warning**

Use the child locks whenever children are occupying the rear seats.

Using a key or suitable screwdriver, turn the child lock in the rear door to the horizontal position. The green LED will go out. The door cannot be opened from the inside. For deactivation turn the child lock to the vertical position.

**Doors****Rear doors****⚠ Warning**

Take care of other persons when getting in or out at the front and rear simultaneously.

Only use the grab handle provided.

The rear doors have an automatic locking feature ⇨ 24.

**Load compartment****Tailgate****Opening**

After unlocking push the touchpad switch under the tailgate moulding and open the tailgate.

Central locking system ⇨ 21.

## Closing



Use one of the interior handles.

Do not push the touchpad switch under the moulding whilst closing as this will unlock the tailgate again.

Central locking system ⇨ 21.

## General hints for operating tailgate

<b>⚠ Warning</b>
------------------

<p>Do not drive with the tailgate open or ajar, e.g. when transporting bulky objects, since toxic exhaust gases, which can not be seen or smelled, could enter the vehicle. This can cause unconsciousness and even death.</p>
--

<b>Caution</b>
----------------

<p>Before opening the tailgate check overhead obstructions, such as a garage door, to avoid damage to the tailgate. Always check the moving area above and behind the tailgate.</p>
---

**Notice**

The installation of certain heavy accessories onto the tailgate may affect its ability to remain open.

## Vehicle security

## Anti-theft locking system

<b>⚠ Warning</b>
------------------

<p>Do not use the system if there are people in the vehicle! The doors cannot be unlocked from the inside.</p>
--

The system deadlocks all the doors. All doors must be closed otherwise the system cannot be activated.

If the ignition was on, the driver's door must be opened and closed once so that the vehicle can be secured.

Unlocking the vehicle disables the mechanical anti-theft locking system. This is not possible with the central locking button.

## Activating



Press  on the radio remote control twice within 10 seconds.

## Anti-theft alarm system

The anti-theft alarm system is operated in conjunction with the central locking system.

It monitors:

- Doors, tailgate, bonnet
- Ignition

Unlocking the vehicle deactivates the anti-theft alarm system.

## Status LED



Status LED is integrated in the central locking button.

Status during the first 10 seconds of anti-theft alarm system activation:

- LED illuminates = test, arming delay.
- LED flashes quickly = doors, tailgate or bonnet not completely closed, or system fault.

Status after system is armed:

- LED flashes slowly = system is armed.

Seek the assistance of a workshop in the event of faults.

## Alarm

When triggered, the horn sounds, and the hazard warning lights flash simultaneously. The number and duration of alarm signals are stipulated by legislation.

The alarm can be silenced by pressing any button of the radio remote control or by switching on the ignition.

The anti-theft alarm system can be deactivated only by pressing button  or by switching on the ignition.

A triggered alarm, which has not been interrupted by the driver, will be indicated by a warning message or a warning code in the Driver Information Centre after switching on the ignition.

Vehicle messages ⇨ 98.

If the vehicle's battery is to be disconnected (e.g. for maintenance work), the alarm siren must be deactivated as follows: switch the

ignition on then off, then disconnect the vehicle's battery within 15 seconds.

## Immobiliser



The system is part of the ignition switch and checks whether the vehicle is allowed to be started with the key being used.

The immobiliser is activated automatically after the key has been removed from the ignition switch.

If the control indicator  flashes when the ignition is on, there is a fault in the system; the engine cannot be started. Switch off the ignition and then repeat the start attempt.

If the control indicator continues flashing, attempt to start the engine using the spare key and seek the assistance of a workshop.

### Notice

The immobiliser does not lock the doors. You should always lock the vehicle after leaving it and switch on the anti-theft alarm system ,  21,  27.

Control indicator   93.

## Exterior mirrors

### Convex shape

The convex exterior mirror contains an aspherical area and reduces blind spots. The shape of the mirror makes objects appear smaller, which will affect the ability to estimate distances.

### Electric adjustment



Select the relevant exterior mirror by turning the control to left (**L**) or right (**R**). Then swivel the control to adjust the mirror.

In position 0 no mirror is selected.

## Folding



For pedestrian safety, the exterior mirrors will swing out of their normal mounting position if they are struck with sufficient force. Reposition the mirror by applying slight pressure to the mirror housing.

## Heated



Operated by pressing the  button. Heating works with the engine running and is switched off automatically after a short time.

## Interior mirrors

### Manual anti-dazzle

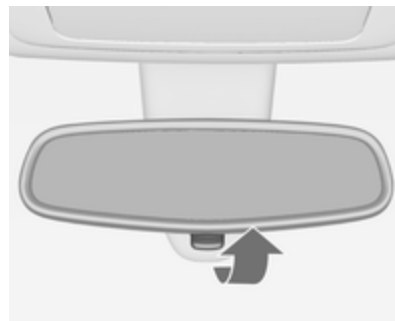

To reduce dazzle, adjust the lever on the underside of the mirror housing.

## Automatic anti-dazzle

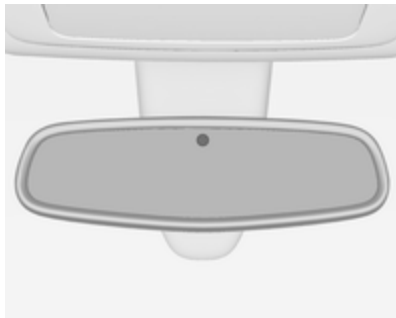

Dazzle from following vehicles at night is automatically reduced.

## Windows

### Windscreen

#### Heat-reflecting windscreen

The heat-reflecting windscreen has a coating which reflects solar radiation. Also data signals, e.g. from toll stations, might be reflected.

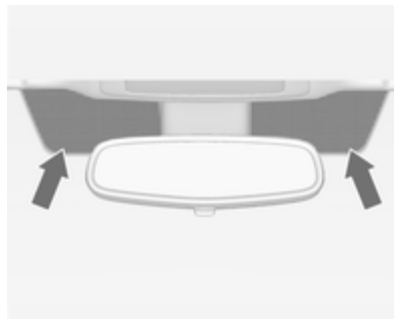

The marked areas of the windscreen behind the interior mirror are not covered with the coating. Devices for electronic data recording and fee

payment must be attached in these areas. Otherwise data recording malfunctions may occur.

### Manual windows

The door windows can be opened or closed with the window winders.

### Power windows

#### Warning

Take care when operating the power windows. Risk of injury, particularly to children.

If there are children on the rear seats, switch on the child safety system for the power windows.

Keep a close watch on the windows when closing them.

Ensure that nothing becomes trapped in them as they move.



Power windows can be operated:

- with ignition on
- within 10 minutes of switching ignition off
- within 5 minutes of opening or closing a door

After switching off the ignition, window operation is disabled as soon as the vehicle is locked with the radio remote control.



Operate the switch for the respective window by pushing to open or pulling to close.

Pushing or pulling gently to the first detent: window moves up or down as long as switch is operated.

Pushing or pulling firmly to the second detent and then releasing: window moves up or down automatically with safety function enabled. To stop movement, operate the switch once more in the same direction.

### Safety function



If the window glass encounters resistance above the middle of the window during automatic closing, it is immediately stopped and opened again.

### Override safety function

In the event of closing difficulties due to frost or the like, switch on the ignition, then pull the switch to the first detent and hold. The window moves up without safety function enabled. To stop movement, release the switch.

### Child safety system for rear windows



Press switch  to deactivate rear door power windows, the LED illuminates. To activate, press  again.

### Operating windows from outside

The windows can be operated remotely from outside the vehicle.

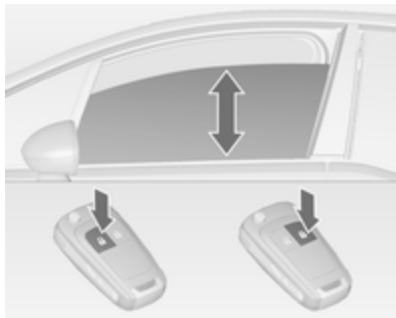

Press and hold  button to open windows.

Press and hold  button to close windows.

Release button to stop window movement.

### Overload

If the windows are repeatedly operated within short intervals, the window operation is disabled for some time.

### Initialising the power windows

If the windows cannot be closed automatically (e.g. after disconnecting the vehicle battery), a warning message or a warning code is displayed in the Driver Information Centre.

Vehicle messages ⇨ 98.

Activate the window electronics as follows:

1. Close doors.
2. Switch on ignition.
3. Pull switch until the window is closed and keep pulling for additional 2 seconds.
4. Repeat for each window.

### Heated rear window



Operated by pressing the  button.

Heating works with the engine running and is switched off automatically after a short time.

Depending on the engine type, the heated rear window comes on automatically when the diesel particle filter is being cleaned.

### Sun visors

The sun visors can be folded down or swivelled to the side to prevent dazzling.

If the sun visors have integral mirrors, the mirror covers should be closed when driving.

A ticket holder is located on the back of the sun visor.

## Roof



### Moonroof



Do not affix any stickers to the roof.  
Do not cover the vehicle using a tarpaulin.

### Sunblind

The sunblind is electrically operated.



Press button  or  gently to the first detent: the sunblind is opened or closed as long as the switch is operated.

Press button  or  firmly to the second detent and then release: the sunblind is opened or closed automatically. To stop movement, operate the switch once more.

### Safety function

If the sunblind encounters resistance during automatic closing, it is immediately stopped and opened again.

### Function standby

In ignition switch position 1 the sunblind is operable ⇨ 126.

### Initialising after a power failure

After a power failure, it may only be possible to operate the sunblind to a limited extent. Have the system initialised by your workshop.

## Seats, restraints

Head restraints .....	34
Front seats .....	36
Rear seats .....	41
Seat belts .....	43
Airbag system .....	46
Child restraints .....	50

## Head restraints

### Position

#### ⚠ Warning

Only drive with the head restraint set to the proper position.

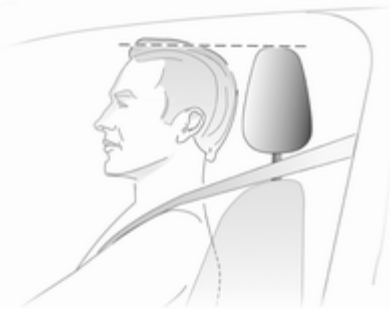

The upper edge of the head restraint should be at upper head level. If this is not possible for extremely tall people, set to highest position, and set to lowest position for small people.

## Adjustment

### Head restraints on front seats

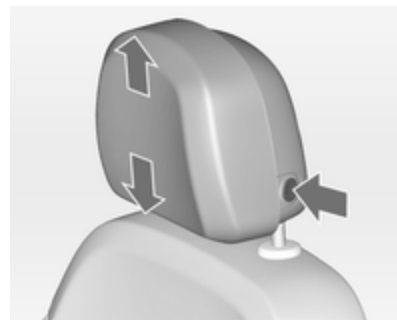

### Height adjustment

Press the button, adjust height and engage.

### Horizontal adjustment



To adjust horizontally, pull the head restraint forwards. It engages in several positions.

To return to its rearmost position, pull fully forwards and release.

### Head restraints on rear seats



### Height adjustment

Pull the head restraint upwards or press both catches to release and push the head restraint downwards.

### Active head restraints

In the event of a rear-end impact, the front parts of the active head restraints are moved slightly forwards. Thus the head is supported so that the risk of whiplash injury is reduced.

### Notice

Approved accessories may only be attached if the seat is not in use.

## Front seats

### Seat position

#### **⚠ Warning**

Only drive with the seat correctly adjusted.



- Sit with buttocks as far back against the backrest as possible. Adjust the distance between the seat and the pedals so that legs are slightly angled when pressing the pedals. Slide the front passenger seat as far back as possible.

- Sit with shoulders as far back against the backrest as possible. Set the backrest rake so that it is possible to easily reach the steering wheel with arms slightly bent. Maintain contact between shoulders and the backrest when turning the steering wheel. Do not angle the backrest too far back. We recommend a maximum rake of approx. 25°.
- Adjust the steering wheel ⇨ 77.
- Set seat height high enough to have a clear field of vision on all sides and of all display instruments. There should be at least one hand of clearance between head and the roof frame. Your thighs should rest lightly on the seat without pressing into it.
- Adjust the head restraint ⇨ 34.
- Adjust the height of the seat belt ⇨ 44.
- Adjust the thigh support so that there is a space approx. two fingers wide between the edge of the seat and the hollow of the knee.

- Adjust the lumbar support so that it supports the natural shape of the spine.

### Seat adjustment

#### **⚠ Danger**

Do not sit nearer than 25 cm from the steering wheel, to permit safe airbag deployment.

#### **⚠ Warning**

Never adjust seats while driving as they could move uncontrollably.

### Seat positioning

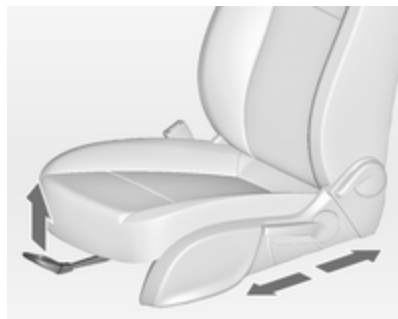

Pull handle, slide seat, release handle.

### Seat backrests

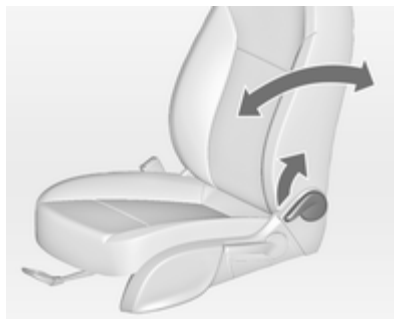

Pull lever, adjust inclination and release lever. Allow the backrest to engage audibly.

### Seat height

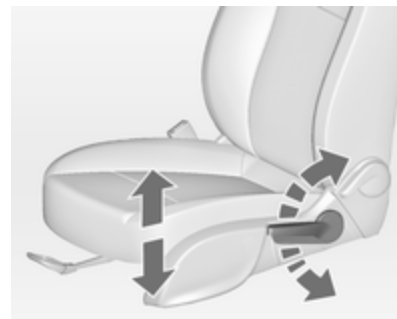

Lever pumping motion  
up = seat higher  
down = seat lower

### Seat inclination

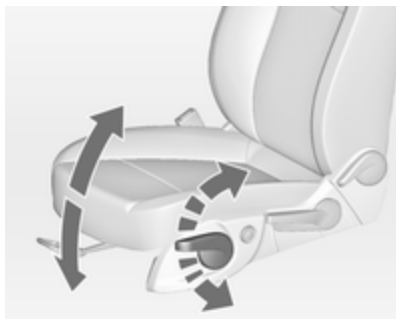

Lever pumping motion

up = front end higher

down = front end lower

### Lumbar support

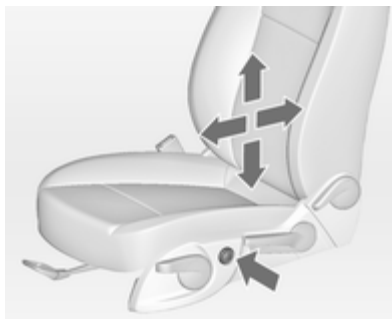

Adjust lumbar support using the four-way switch to suit personal requirements.

Moving support up and down: push switch up or down.

Increasing and decreasing support: push switch forwards or backwards.

### Adjustable thigh support

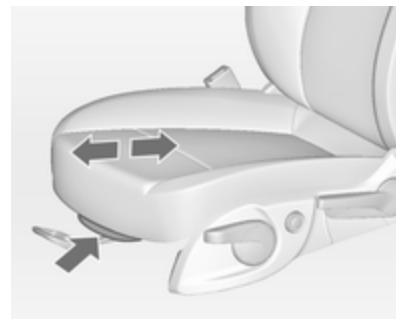

Pull the lever and slide the thigh support.



## Armrest

### Detachable armrest

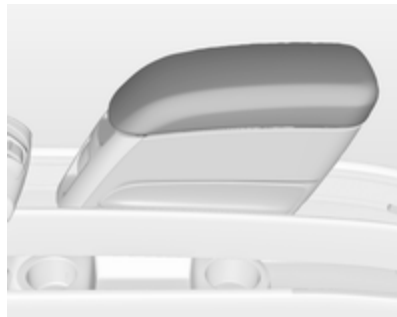

The armrest contains a storage compartment.

Storage compartment ⇨ 60.

### Installing armrest

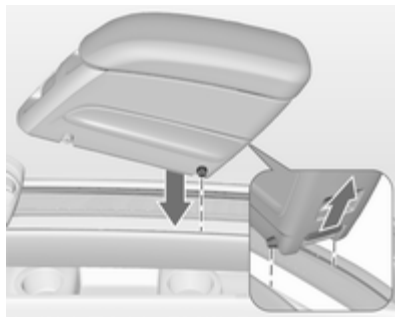

Press the rear button and insert the rear guide pins into the upper guide rails. Release the button.

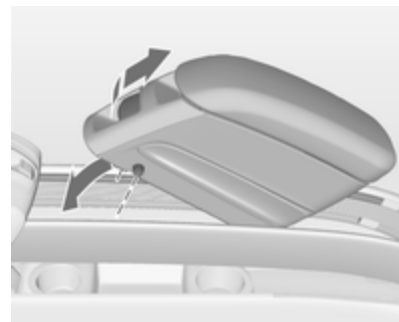

Lower the armrest at the front. Pull the front handle firmly and insert the front guide pins into the upper guide rails. Release the handle. Move the armrest until it engages audibly.

#### **Notice**

Install the armrest in the direction as shown in the illustration. Otherwise the armrest may not engage properly.

### Moving armrest

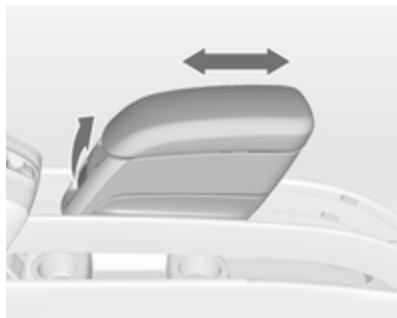

Pull the front handle slightly and move the armrest to the desired position. Release the handle. Move the armrest until it engages audibly.

If a cupholder is installed in the lower guide rail, make sure that the frame of the cupholder is in the initial position.

**Notice**

If too much weight is put on the armrest, it might unlatch. Ease of movement might be restricted. Lift the armrest slightly to latch again.

Armrest storage ⇨ 60.

Cupholders ⇨ 57.

### Removing armrest

Pull the front handle firmly and raise the armrest at the front. Press the rear button and remove the armrest.

### Heating



Adjust heating to the desired setting by pressing the ☀ button for the respective seat one or more times. The control indicator in the button indicates the setting.

Prolonged use of the highest setting for people with sensitive skin is not recommended.

Seat heating is operational when engine is running and during an Autostop.

Stop-start system ⇨ 128.

## Rear seats

### Seat adjustment

#### **⚠ Warning**

Only drive with the outer seats engaged in the guide rails.

#### **⚠ Warning**

Never adjust seats while driving as they could move uncontrollably.



The rear outboard seats can be individually moved forward or backward. The seats are movable in longitudinal and transversal direction.

In longitudinal direction the seats can be engaged in intermediate positions.

Pull handle, slide seat, release handle and allow seat to engage.

### Flexible Seat System (FlexSpace)

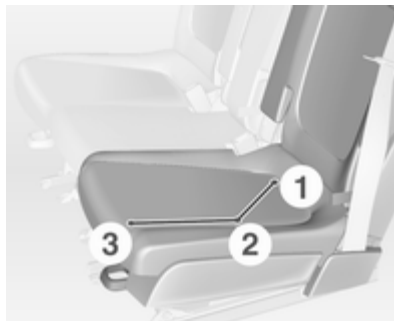

The rear seat row can be adjusted with two seats providing maximum seating space in position 1, or with three seats in position 2. In position 1 the centre seat is lowered.

The outboard seats can be moved forward into position 3.

### Moving seats to position 1



Pull the strap and fold down the centre seat.



Pull handle and slide the seat transversely backward into position **1**. The seat is automatically guided inward. Release handle and allow seat to engage in position.

### Moving seats to position 2



Pull handle and slide the seat transversely forwards into position **2**. The seat is automatically guided outward. Release handle and allow seat to engage in position.



Pull the strap and raise the centre seat.

The centre seat is not usable if the outer seats are moved forward in position **3**.

## Seat belts



The seat belts are locked during heavy acceleration or deceleration of the vehicle holding the occupants in the sitting position. Therefore the risk of injury is considerably reduced.

### ⚠ Warning

Fasten seat belt before each trip. In the event of an accident, people not wearing seat belts endanger their fellow occupants and themselves.

Seat belts are designed to be used by only one person at a time. They are not suitable for people smaller than 150 cm. Child restraint system ⇨ 50.

Periodically check all parts of the belt system for damage, pollution and proper functionality.

Have damaged components replaced. After an accident, have the belts and triggered belt pretensioners replaced by a workshop.

### Notice

Make sure that the belts are not damaged by shoes or sharp-edged objects or are trapped. Prevent dirt from getting into the belt retractors.

Seat belt reminder 🚨 ⇨ 88.

### Belt force limiters

Stress on the body is reduced by the gradual release of the belt during a collision.

### Belt pretensioners

In the event of a head-on or rear-end collision of a certain severity, the front seat belts are tightened.

### ⚠ Warning

Incorrect handling (e.g. removal or fitting of belts) can trigger the belt pretensioners.

Deployment of the belt pretensioners is indicated by continuous illumination of control indicator 🚨 ⇨ 88.

Triggered belt pretensioners must be replaced by a workshop. Belt pretensioners can only be triggered once.

### Notice

Do not affix or install accessories or other objects that may interfere with the operation of the belt pretensioners. Do not make any modifications to belt pretensioner components as this will invalidate the vehicle type approval.

## Three-point seat belt

### Fastening seat belt



Withdraw the belt from the retractor, guide it untwisted across the body and insert the latch plate into the buckle. Tighten the lap belt regularly whilst driving by pulling the shoulder belt.

Seat belt reminder ⇨ 88.

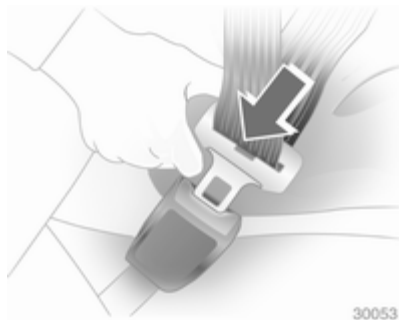

Loose or bulky clothing prevents the belt from fitting snugly. Do not place objects such as handbags or mobile phones between the belt and your body.

### **⚠ Warning**

The belt must not rest against hard or fragile objects in the pockets of your clothing.

## Height adjustment



1. Pull belt out slightly.
2. Press button.
3. Adjust height and engage.



Adjust the height so that the belt lies across the shoulder. It must not lie across the throat or upper arm.

Do not adjust while driving.

### Removing seat belt



30054

To release belt, press red button on belt buckle.

### Seat belts on the rear seats

The centre rear seat is equipped with a particular three-point seat belt.

Pull latch plates out of belt retainer in roof.



Click bottom latch plate into right-hand buckle (1) at centre seat. Remove top latch plate from retainer, guide over shoulder and lap area with belt (do not twist) and click into left-hand buckle (2) at centre seat.

To remove the seat belt, first press the button on the left-hand buckle (2) and remove top latch plate. Then press the button on the right-hand buckle (1) and remove bottom latch plate. The seat belt retracts automatically.

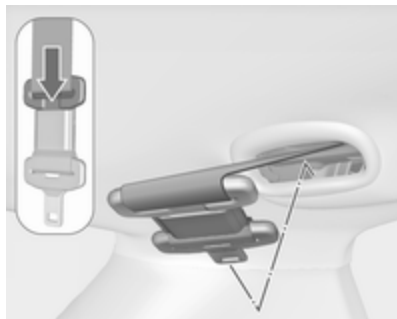

Push the top latch plate into the retainer. Fold over locked together latch plates against the seat belt.



Insert in the seat belt holder in the roof with the lower latch plate pointing forward.

### Using the seat belt while pregnant



#### **⚠ Warning**

The lap belt must be positioned as low as possible across the pelvis to prevent pressure on the abdomen.

## Airbag system

The airbag system consists of a number of individual systems depending on the scope of equipment.

When triggered the airbags inflate within milliseconds. They also deflate so quickly that it is often unnoticeable during the collision.

#### **⚠ Warning**

If handled improperly the airbag systems can be triggered in an explosive manner.



### Notice



The airbag systems and belt pretensioner control electronics are located in the centre console area. Do not put any magnetic objects in this area.

Do not stick anything on the airbag covers and do not cover them with other materials.

Each airbag is triggered only once. Have deployed airbags replaced by a workshop. Furthermore, it might be necessary to have the steering wheel, the instrument panel, parts of the panelling, the door seals, handles and the seats replaced.

Do not make any modifications to the airbag system as this will invalidate the vehicle type approval.

When the airbags inflate, escaping hot gases may cause burns.

Control indicator  for airbag systems  88.

## Front airbag system

The front airbag system consists of one airbag in the steering wheel and one in the instrument panel on the front passenger side. These can be identified by the word **AIRBAG**.



There are also warning labels on both sides of the sunblind on the front passenger side.

The front airbag system is triggered in the event of a front-end impact of a certain severity. The ignition must be switched on.

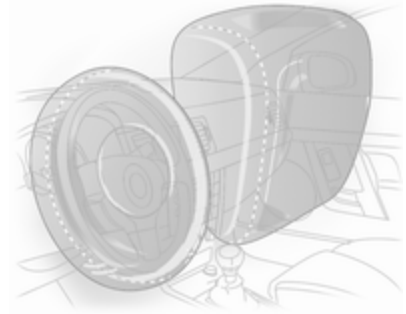

The inflated airbags cushion the impact, thereby reducing the risk of injury to the upper body and head of the front seat occupants considerably.

### ⚠ Warning

Optimum protection is only provided when the seat is in the proper position ⇨ 36.

Keep the area in which the airbag inflates clear of obstructions.

Fit the seat belt correctly and engage securely. Only then the airbag is able to protect.

## Side airbag system



The side airbag system consists of an airbag in each front seat backrest. This can be identified by the word **AIRBAG**.

The side airbag system is triggered in the event of a side impact of a certain severity. The ignition must be switched on.

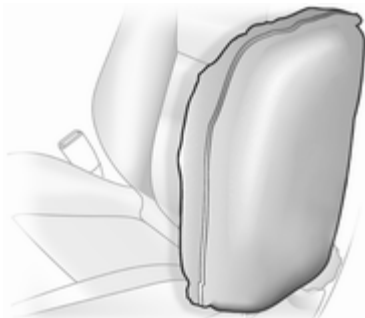

The inflated airbags cushion the impact, thereby reducing the risk of injury to the upper body and pelvis in the event of a side-on collision considerably.

### ⚠ Warning

Keep the area in which the airbag inflates clear of obstructions.

#### Notice

Only use protective seat covers that have been approved for the vehicle. Be careful not to cover the airbags.

## Curtain airbag system

The curtain airbag system consists of an airbag in the roof frame on each side. This can be identified by the word **AIRBAG** on the roof pillars.

The curtain airbag system is triggered in the event of a side-on impact of a certain severity. The ignition must be switched on.

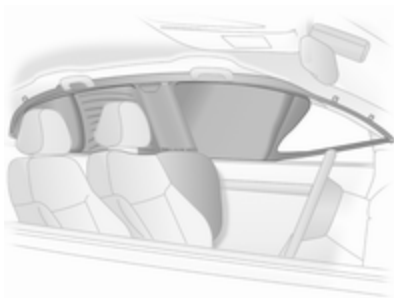

The inflated airbags cushion the impact, thereby reducing the risk of injury to the head in the event of a side-on impact considerably.

### **⚠ Warning**

Keep the area in which the airbag inflates clear of obstructions.

The hooks in the roof frame are only suitable for hanging up light articles of clothing, without coat hangers. Do not keep any items in these clothes.

## Airbag deactivation

The front passenger airbag system has to be deactivated if a child restraint system is to be fitted on this seat. The side airbag and curtain airbag systems, the belt pretensioners and all driver airbag systems will remain active.

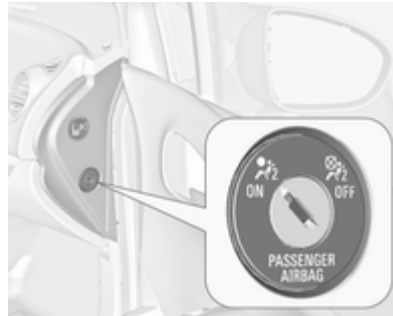

The front passenger airbag system can be deactivated via a key-operated switch on the right side of the instrument panel.

Use the ignition key to choose the position:

- ⚠ = front passenger airbag is deactivated and will not inflate in the event of a collision. Control indicator ⚠ illuminates continuously in the centre console. A child restraint system can be installed in accordance with the chart **Child restraint installation locations** ↪ 53. No adult person is allowed to occupy the front passenger seat.
- ⚠ = front passenger airbag is active. A child restraint system must not be installed.

### **⚠ Danger**

Risk of fatal injury for a child using a child restraint system on a seat with activated front passenger airbag.

Risk of fatal injury for an adult person on a seat with deactivated front passenger airbag.



Status remains until the next change.

Control indicator for airbag deactivation ⇨ 89.

As long as the control indicator  is illuminated, the front passenger airbag system will inflate in the event of a collision.

If both control indicators are illuminated at the same time, there is a system failure. The status of the system is not discernible, therefore no person is allowed to occupy the front passenger seat. Contact a workshop immediately.

Consult a workshop immediately if neither of the two control indicators is illuminated.

Change status only when the vehicle is stopped with the ignition off.

## Child restraints

### Child restraint systems

We recommend the Vauxhall child restraint system which is tailored specifically to the vehicle.

When using the Vauxhall child restraint system, move the rear outboard seats into position 2 ⇨ 41.

We recommend fastening the Vauxhall child restraint system by using the following securing systems in combination:

#### ISOFIX



### Three-point seat belt

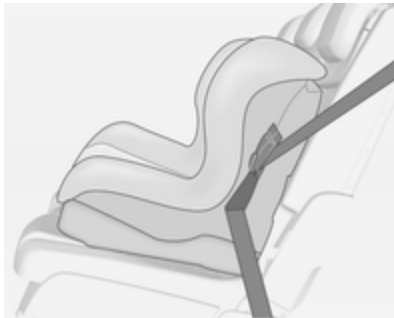

### Top-Tether



When a child restraint system is being used, pay attention to the following usage and installation instructions and also those supplied with the child restraint system.

Always comply with local or national regulations. In some countries, the use of child restraint systems is forbidden on certain seats.

#### **⚠ Warning**

When using a child restraint system on the front passenger seat, the airbag systems for the front passenger seat must be deactivated; if not, the triggering of the airbags poses a risk of fatal injury to the child.

This is especially the case if rear-facing child restraint systems are used on the front passenger seat.

### Selecting the right system

The rear seats are the most convenient location to fasten a child restraint system.

Children should travel facing rearwards in the vehicle as long as possible. This makes sure that the child's backbone, which is still very weak, is under less strain in the event of an accident.

Children under the age of 12 years that are smaller than 150 cm are only allowed to travel in a restraint system that is suitable for the child. Suitable are restraint systems that comply with ECE 44-03 or ECE 44-04. Since a proper position of the belt is rarely possible with a child that is smaller than 150 cm, we strongly advise the use of an appropriate child restraint system, even though this might, due to the age of the child, no longer be legally binding.

Ensure that the child restraint system to be installed is compatible with the vehicle type.

Ensure that the mounting location of the child restraint system within the vehicle is correct.

Allow children to enter and exit the vehicle only on the side facing away from the traffic.

When the child restraint system is not in use, secure the seat with a seat belt or remove it from the vehicle.

**Notice**

Do not stick anything on the child restraint systems and do not cover them with any other materials.

A child restraint system which has been subjected to stress in an accident must be replaced.

## Child restraint installation locations

### Permissible options for fitting a child restraint system

Weight and age class	On front passenger seat		On rear outboard seats	On rear centre seat
	activated airbag	deactivated airbag		
<b>Group 0: up to 10 kg</b> or approx. 10 months	X	U <sup>1</sup>	U <sup>2, 4</sup>	U <sup>3</sup>
<b>Group 0+: up to 13 kg</b> or approx. 2 years	X	U <sup>1</sup>	U <sup>2, 4</sup>	U <sup>3</sup>
<b>Group I: 9 to 18 kg</b> or approx. 8 months to 4 years	X	U <sup>1</sup>	U <sup>2, 4</sup>	U <sup>3</sup>
<b>Group II: 15 to 25 kg</b> or approx. 3 to 7 years	X	X	U <sup>4</sup>	U <sup>3</sup>
<b>Group III: 22 to 36 kg</b> or approx. 6 to 12 years	X	X	U <sup>4</sup>	U <sup>3</sup>

- <sup>1</sup> = Only if front passenger seat airbag system is deactivated. If the child restraint system is being secured using a three-point seat belt, move seat height adjustment to uppermost position and ensure that vehicle seat belt runs forwards from the upper anchorage point.
- <sup>2</sup> = Seat available with ISOFIX and Top-Tether mounting brackets.
- <sup>3</sup> = Only if outboard seats are flush with the centre seat (position 2, ⇨ 41).
- <sup>4</sup> = Only if outboard seats are in position 1 or 2, ⇨ 41.
- U = Universal suitability in conjunction with three-point seat belt.
- X = No child restraint system permitted in this weight and age class.

### Permissible options for fitting an ISOFIX child restraint system

Weight class	Size class	Fixture	On front passenger seat	On rear outboard seats <sup>1,2</sup>	On rear centre seat
<b>Group 0: up to 10 kg</b>	E	ISO/R1	X	IL	X
<b>Group 0+: up to 13 kg</b>	E	ISO/R1	X	IL	X
	D	ISO/R2	X	IL	X
	C	ISO/R3	X	IL	X
<b>Group I: 9 to 18 kg</b>	D	ISO/R2	X	IL	X
	C	ISO/R3	X	IL	X
	B	ISO/F2	X	IL, IUF	X
	B1	ISO/F2X	X	IL, IUF	X
	A	ISO/F3	X	IL, IUF	X



- 
- IL = Suitable for particular ISOFIX restraint systems of the 'specific-vehicle', 'restricted' or 'semi-universal' categories. The ISOFIX restraint system must be approved for the specific vehicle type.
- IUF = Suitable for ISOFIX forward-facing child restraint systems of universal category approved for use in this weight class.
- X = No ISOFIX child restraint system approved in this weight class.
- <sup>1</sup> = Only if outboard seats are in position **1** or **2**, ⇨ 41.
- <sup>2</sup> = Only Vauxhall child restraint system: If the seat is secured as recommended ⇨ 50, the outboard seats must be in position **2** ⇨ 41.

### **ISOFIX size class and seat device**

- A – ISO/F3 = Forward-facing child restraint system for children of maximum size in the weight class 9 to 18 kg.
- B – ISO/F2 = Forward-facing child restraint system for smaller children in the weight class 9 to 18 kg.
- B1 – ISO/F2X = Forward-facing child restraint system for smaller children in the weight class 9 to 18 kg.
- C – ISO/R3 = Rear-facing child restraint system for children of maximum size in the weight class up to 13 kg.
- D – ISO/R2 = Rear-facing child restraint system for smaller children in the weight class up to 13 kg.
- E – ISO/R1 = Rear-facing child restraint system for young children in the weight class up to 13 kg.

## ISOFIX child restraint systems



Fasten vehicle-approved ISOFIX child restraint systems to the ISOFIX mounting brackets. Specific vehicle ISOFIX child restraint system positions are marked in the table by IL.

ISOFIX mounting brackets are indicated by a label on the backrest.

## Top-tether fastening eyes

Top-Tether fastening eyes are marked with the symbol  for a child seat.



In addition to the ISOFIX mounting, fasten the Top-Tether strap to the Top-Tether fastening eyes. The strap must run between the two guide rods of the head restraint.

ISOFIX child restraint systems of universal category positions are marked in the table by IUF.

## Storage

Storage compartments .....	57
Load compartment .....	69
Roof rack system .....	75
Loading information .....	75

## Storage compartments

### Glovebox

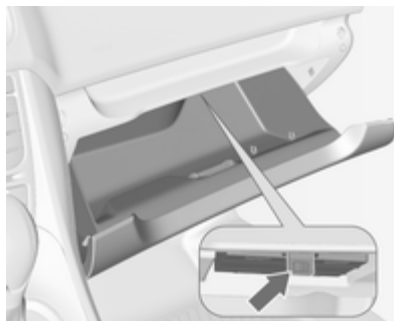

The glovebox features a pen holder and a coin holder.

Inside the glovebox there is a compartment for the Owner's Manual. Pull the lug to open the compartment.

The glovebox should be closed whilst driving.

## Cupholders

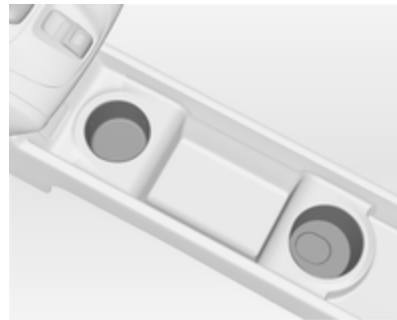

Cupholders are located in the centre console.

### Detachable cupholder

A cupholder can be attached either to the upper or lower guide rails in the front console.

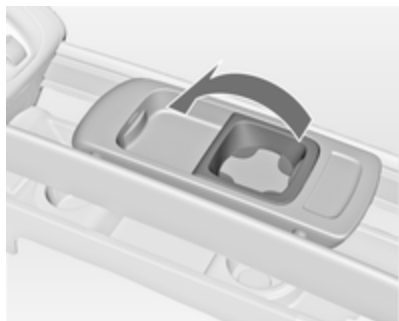

Fold the frame out of initial position before using.

#### Notice

If the cupholder is installed in the lower guide rail and the detachable armrest in the upper guide rail, make sure that the frame is folded back into the initial position before moving one of the parts. Otherwise the armrest and the cupholder might be damaged while moving them one above the other.

Armrest ⇄ 39.

#### Installing cupholder

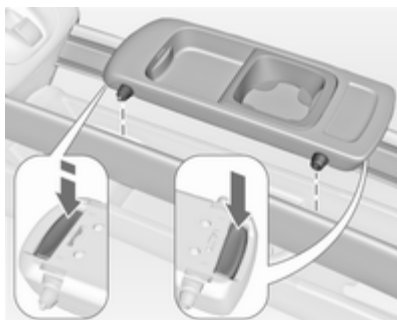

Press the buttons at the front and the rear and insert the guide pins into the upper or lower guide rails. The front button has to be pressed firmly. Release the buttons and move the cupholder until it engages audibly.

#### Notice

Install the cupholder in the direction as shown in the illustration. Otherwise the cupholder may not engage properly.

#### Moving cupholder

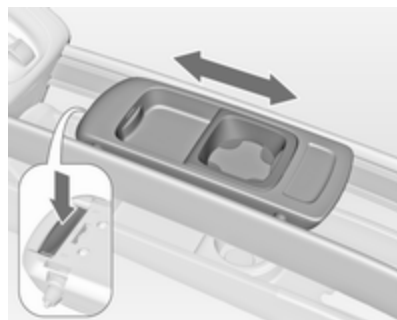

Press the front button slightly and move the cupholder to the desired position. Release the button and move the cupholder until it engages audibly.

#### Removing cupholder

Press the buttons at the front and the rear and remove the cupholder. The front button has to be pressed firmly.

## Front storage



A storage compartment is located next to the steering wheel.

## Sunglasses storage

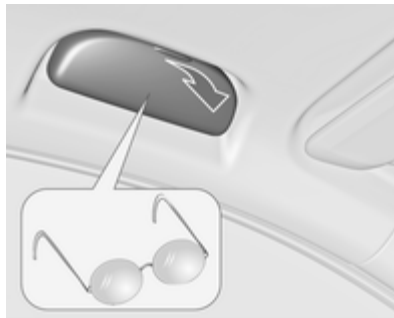

Fold down and open.  
Do not use for storing heavy objects.

## Underseat storage



Lift drawer at recessed edge and pull out. Maximum load: 3 kg. To close, push the drawer in and engage.

## Armrest storage

### Storage in the detachable armrest

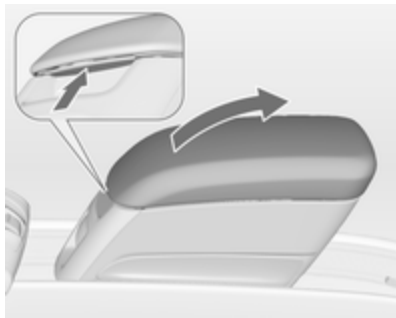

Push button and fold the armrest lid upwards. The armrest contains a storage compartment.

## Rear carrier system



The rear carrier system (Flex-Fix system) allows bicycles to be attached to a pull-out carrier integrated into the vehicle floor. The transportation of other objects is not permitted.

The maximum load of the rear carrier system is 40 kg. The maximum load per bicycle is 20 kg.

If not in use, the carrier system can be slid back into the vehicle floor.

There must not be any objects on the bicycles that could become loose during transportation.

### Caution

Do not attach bicycles with carbon pedal cranks to bicycle carriers. The bicycles might get damaged.

### Extending

Open the tailgate.

### Warning

No people may remain in the extension zone of the rear carrier system, risk of injury.

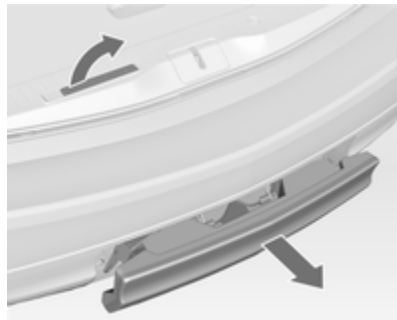

Pull release lever up. The system disengages and travels quickly out of the bumper.

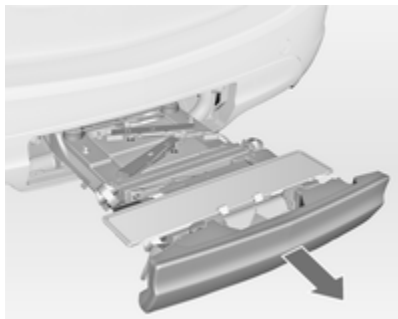

Completely pull out the rear carrier system until you hear it engage. Ensure that it is not possible to push in the rear carrier system without pulling the release lever again

### **⚠ Warning**

It is only permissible to fit objects to the rear carrier system if the system has been correctly engaged. If the rear carrier system will not engage correctly, do not fit objects to the system and slide the system back. Seek the assistance of a workshop.

### **Install the tail lamps**

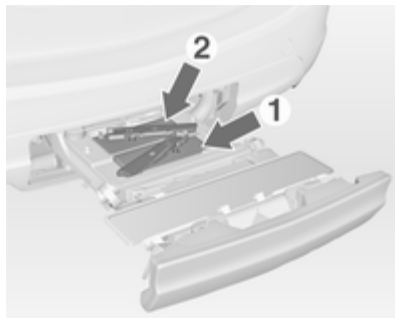

First remove the rear (1), then the front (2) tail lamp from the recesses.

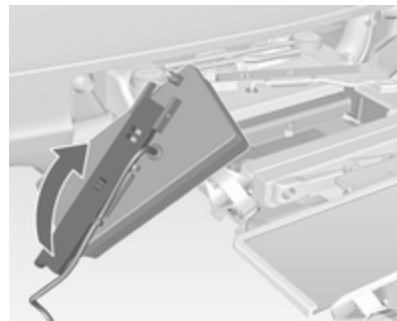

Open out the lamp support on the back of the tail lamp completely.

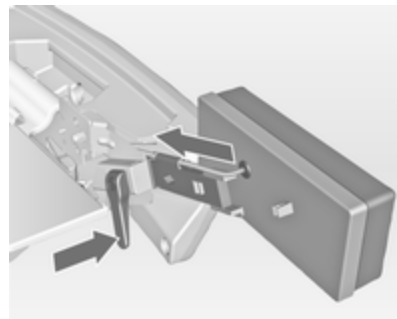

Push the clamping lever down and push the lamp support into the retainer until it engages.

Perform this procedure for both tail lamps.

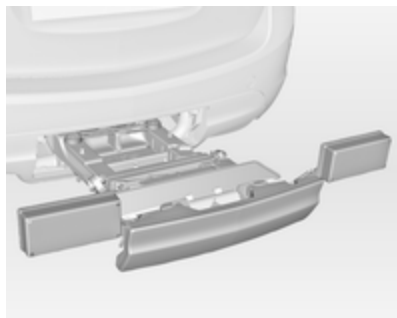

Check the cable and lamp position to make sure these are correctly installed and are securely located.

### Lock the rear carrier system

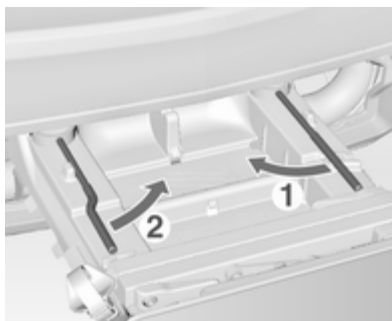

Swivel the right clamping lever (1) first, followed by the left clamping lever (2), until a resistance is noticeable.

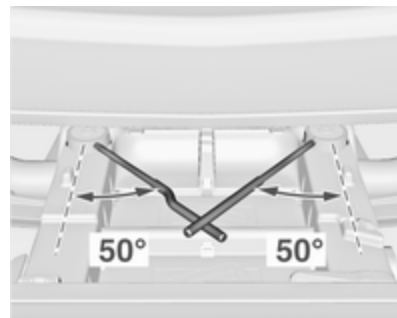

The rear carrier system is locked when the clamping levers are swivelled by approx. 50°. Otherwise safe functionality is not guaranteed.

#### Notice

Close the tailgate.



### Unfold the number plate holder

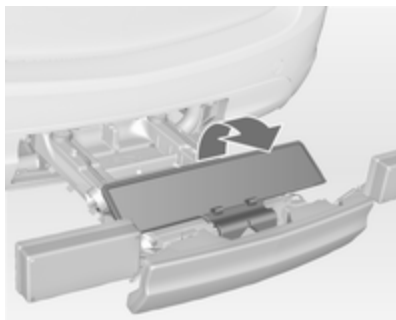

Unfold the holder for the number plate.

Affix the number plate once before first usage of the rear carrier system.

### Unfold pedal crank recesses

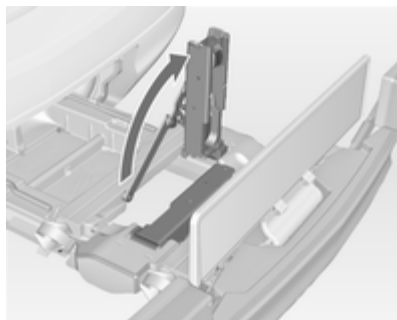

Fold one or both pedal crank recesses upwards until the diagonal support engages.

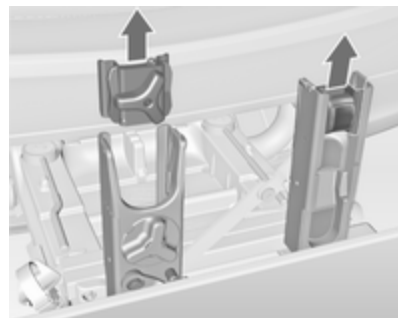

Remove the pedal crank mounts from the pedal crank recesses.

### Adapting the rear carrier system to a bicycle

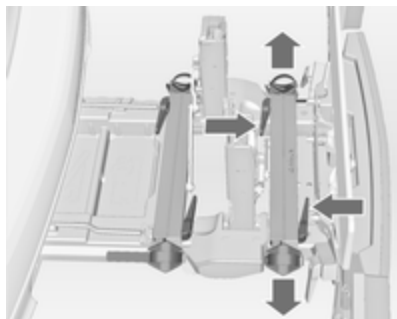

Press the release lever and withdraw the wheel recesses.

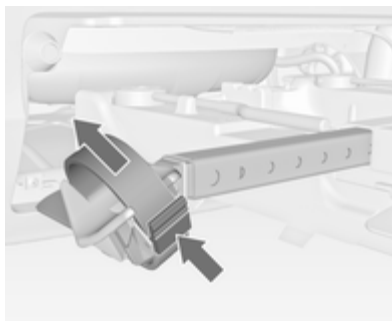

Push the release lever on the strap retainer and remove the strap retainer.

### Prepare the bicycle for attachment

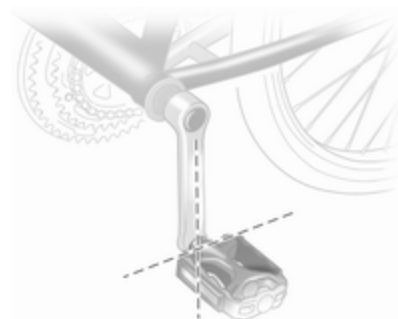

#### Notice

The maximum width for the pedal crank is 38.3 mm and the maximum depth is 14.4 mm.

Rotate the left pedal (without a chain cog) vertically downwards. The pedal on the left pedal crank must be horizontal.

The front bicycle must have its front wheel facing left.

The rear bicycle must have its front wheel facing right.

## Attaching a bicycle to the rear carrier system

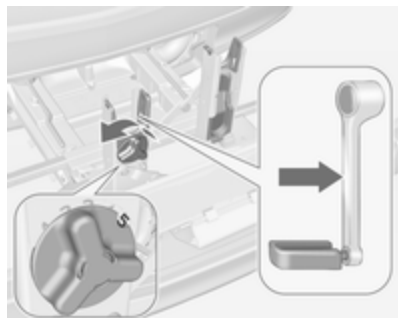

With the rotary lever on the pedal crank recess, roughly adapt the adjustable pedal crank unit to the protrusion of the pedal crank.

If the bicycle has straight pedal cranks, unscrew the pedal crank unit completely (position 5).

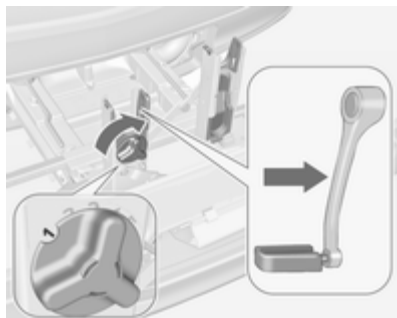

If the bicycle has curved pedal cranks, screw in the pedal crank unit all the way (position 1).

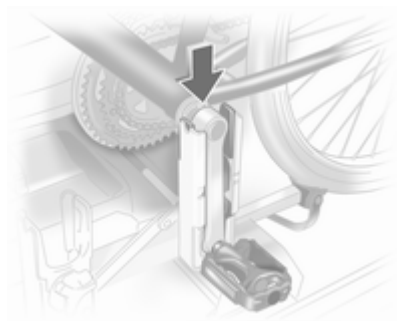

Put on the bicycle. The pedal crank here must be placed in the pedal crank recess opening as shown in the illustration.

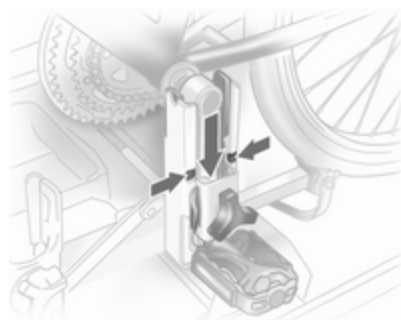

Insert pedal crank mount into outer rail of each pedal crank recess from above and slide downwards until at least underneath the notching.

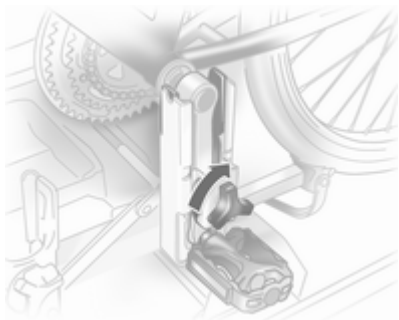

Attach the pedal crank by rotating the attachment screw on the pedal crank mount.



Place the wheel recesses such that the bicycle is more or less horizontal. Here, the distance between the pedals and the tailgate should be at least 5 cm.

Both bicycle tyres must be in the wheel recesses.

### Caution

Make sure that the pedal does not touch the surface of the rear end carrier. Otherwise the crankset might be damaged during the transport.

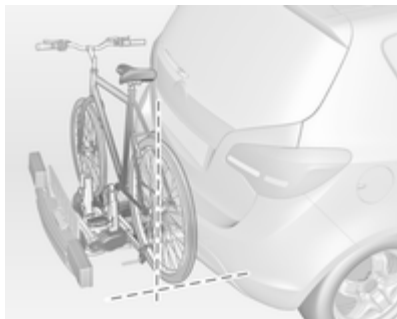

Align the bicycle in the longitudinal direction of the vehicle: Slightly loosen the pedal mount.

Place the bicycle upright using the rotary lever on the pedal crank recess.

If the two bicycles obstruct one another, the relative positions of the bicycles can be adapted by adjusting the wheel recesses and the rotary lever on the pedal crank recess until the bicycles no longer touch one another. Make sure there is sufficient clearance from the vehicle.

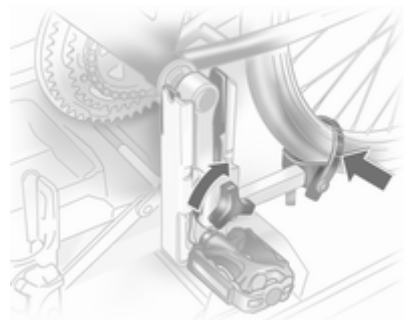

Tighten the attachment screw for the pedal bearing mount to its maximum point by hand.

Secure both bicycle wheels to wheel recesses using strap retainers.

Check the bicycle to make sure it is secure.

The settings for the wheel recesses and on the rotary lever on the pedal crank recess should be noted and saved for each bicycle. Correct presetting will facilitate refitting of the bicycle.

### Removing a bicycle from the rear carrier system

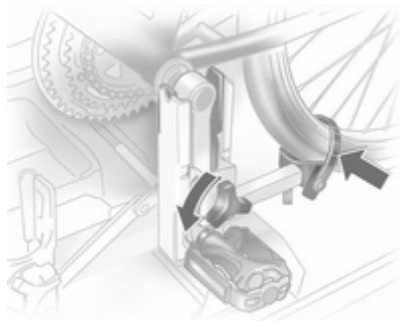

Undo strap retainers on both bicycle tyres.

Hold on to the bicycle, loosen the attachment screw for the pedal bearing mount, then lift the pedal bearing mount to remove it.

### Retracting the rear carrier system

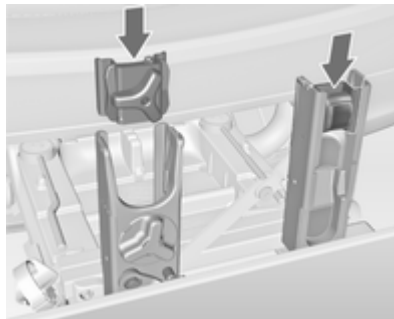

Push the pedal crank mounts into the pedal crank recess like shown in the illustration.

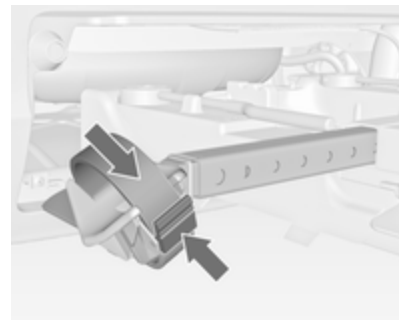

Insert the strap retainer and pull tightly downwards as far as possible.

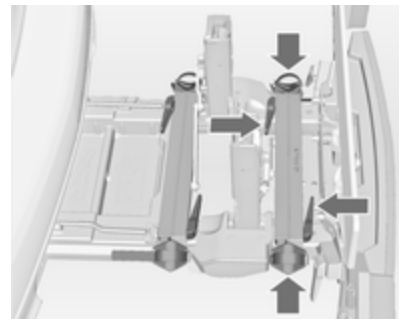

Press release lever and slide in wheel recesses all the way as far as they will go.

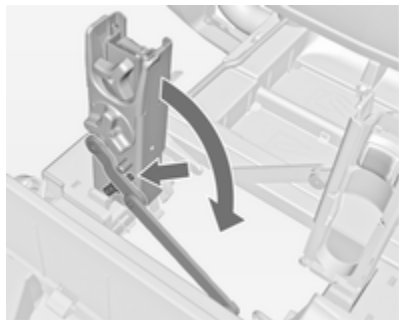

Disengage the locking lever on the diagonal support and fold both pedal crank recesses down.

**⚠ Warning**

Risk of pinching.

Remove number plate and fold down the number plate holder.



Swivel first the left clamping lever (1), followed by the right clamping lever (2), until they stop.

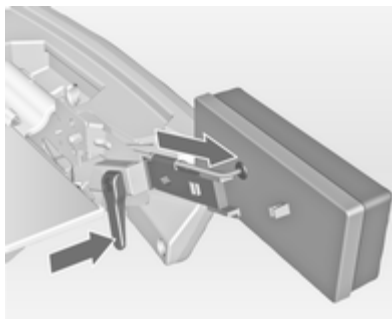

Push the clamping lever down and pull both lamp supports out of the recesses.

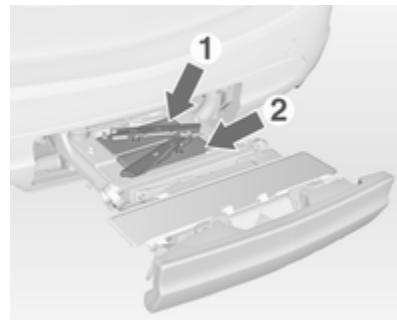

Fold in the lamp supports on the backs of the tail lamps.

First place the front (1) tail lamp, then the rear (2) tail lamp in the recesses and push down as far as possible. Push cables all the way into all guides in order to prevent damage.

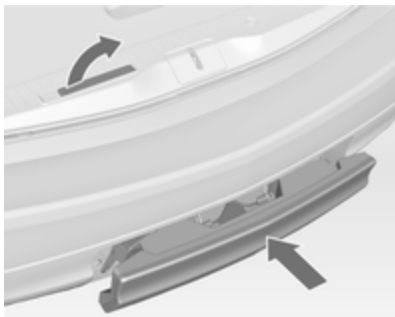

Open the tailgate.

Push the release lever up and push the system into the bumper until it engages.

Release lever must return to original position.

### **⚠ Warning**

If the system cannot be correctly engaged, please seek the assistance of a workshop.

## Load compartment

### Folding down rear seat backrests

The rear seat backrest is divided into three parts. All parts can be folded down and lowered individually to increase the size of the load compartment.

### **⚠ Warning**

Do not stow objects under or behind the seats. The objects might be damaged and prevent the guide rails from locking properly.

A completely flat load bay is created if the rear seat backrests are folded down.

### Caution

Do not fold the outer seatbacks while the seats are in the inner position. The seats could be damaged.

Remove the load compartment cover if necessary ⇨ 70.

Push head restraints down by pressing both catches.



Take the seat belt out of the retaining clip on the backrest.

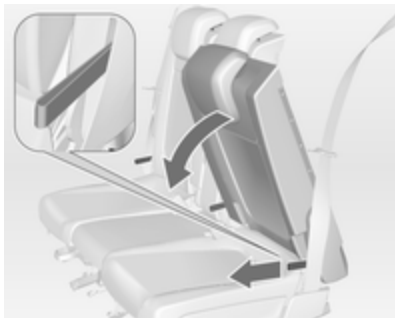

Pull the handle on the front side of the backrest and fold down the backrest onto the seat cushion. The seat is lowered automatically.

The backrests can also be folded from the load compartment.



Pull the handle on the back side of the backrest and fold down the backrest.

To fold up, pull the handle and raise the backrests into an upright position until they engage audibly.

#### **⚠ Warning**

Only drive the vehicle if the backrests are securely locked into position. Otherwise there is a risk of personal injury or damage to the load or vehicle in the event of heavy braking or a collision.

## Rear storage

On the left side of the load compartment there is a stowage compartment.



Turn the fastener anticlockwise and fold down the cover.

## Load compartment cover

Do not place any objects on the cover.



## Removing the cover

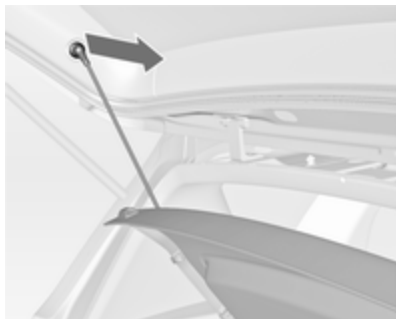

Unhook retaining straps from tailgate.



Lift cover at the rear and push it upwards at the front.

Remove the cover.

## Stowing the cover

Unhook retaining straps from tailgate.

Lift cover at the rear and push it upwards out of the side guides at the front.



Stow the cover behind the rear seats.

## Fitting the cover

Engage cover in side guides and fold downwards. Attach retaining straps to tailgate.

## Rear floor storage cover



The rear floor cover can be lifted.

Fold it up and lift the load compartment cover slightly.

Pull out the hook at the left sidewall of the load compartment to hold the rear floor cover upright.

### Double load-bay floor

The double load-bay floor can be inserted in the load compartment in two positions:

- directly above the cover for the spare wheel well or the rear floor cover,
- in the upper openings in the load compartment.

To remove, lift the load-bay floor using the recess and pull backwards.

To insert, push the load-bay floor forwards in the corresponding guide, then lower.

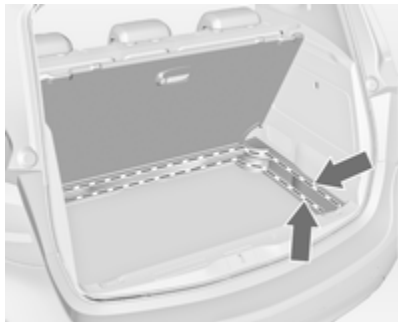

If mounted in the upper position, the space between the load-bay floor and the spare wheel well cover can be used as a stowage compartment.

In this position, if the rear seat backrests are folded forwards, an almost completely flat load bay is created.

In the upper position, the double load-bay floor is able to withstand a maximum load of 100 kg. In the lower position, the double load-bay floor is able to withstand the maximum permissible load.

In models with a tyre repair kit, the spare wheel recess may be used as an additional stowage compartment. Tyre repair kit ↗ 176.

### Lashing eyes

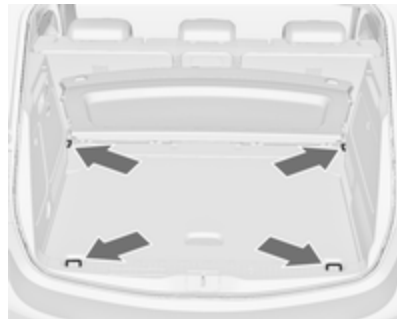

The lashing eyes are designed to secure items against slippage, e.g. using lashing straps or luggage net.

### Safety net

The safety net can be installed behind the front seats.

Passengers must not be transported behind the safety net.

## Installation



There are two installation openings in the roof frame: suspend rod of net at one side, push to the front and engage. Extend rod, suspend at other side, push to the front and engage.

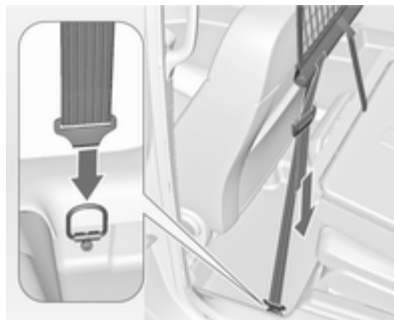

Suspend hooks of net tensioning belts in lashing eyes in the floor behind the front seats. Tension the net by pulling the loose end of the belt. Suspend and tighten on both sides.

## Removal

Tilt length adjuster of the net tensioning belts upwards and detach the belts on both sides. Disengage the upper rod on one side, disengage other side and remove from the openings.

## Stowage

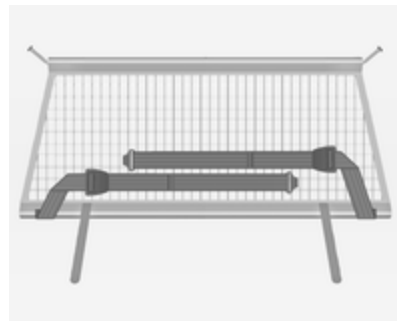

Place tensioning straps as shown in figure and align to net.

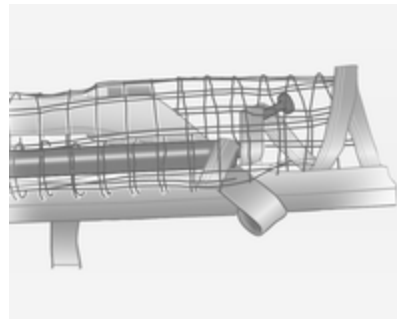

Roll the upper net rod down to approximately over the middle.

Place the upper net rod over the tensioning straps next to the lower net rod. The hooks on the upper net rod must point away from the lower net rod.

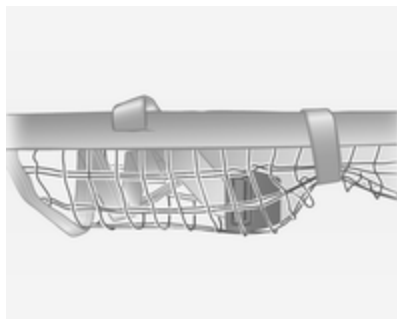

Fasten Velcro tape tightly about the net next to the length adjusters. The length adjusters and net rods must lie flat next to each other.

Stow safety net in the space between the double load-bay floor in the load compartment. Rear floor storage cover ⇨ 71.

## Folding tray

Located in the front seat backrests.

Open by pulling upwards until it engages.

Fold away by pressing down past the resistance point.

Do not place any heavy objects on the folding tray.

## Warning triangle

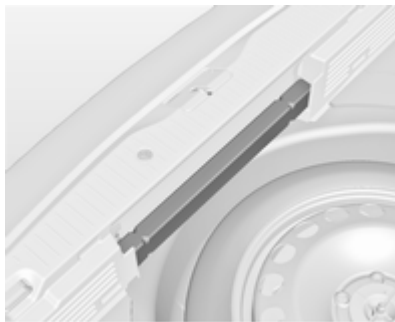

Stow the warning triangle in the space at the rear side of the load compartment.

## First aid kit

Stow the first aid kit and the high visibility vest under the driver's seat.

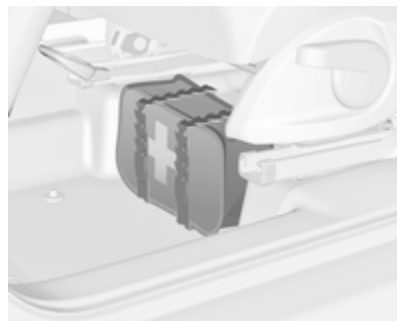

Use the straps.

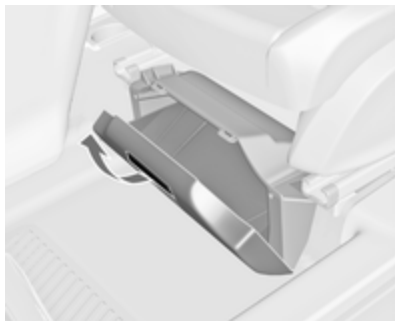

Depending on the vehicle, a box is located under the driver's seat. Pull handle and fold down the cover. Maximum load: 1.5 kg.

## Roof rack system

### Roof rack

For safety reasons and to avoid damage to the roof, the vehicle approved roof rack system is recommended.

Follow the installation instructions and remove the roof rack when not in use.

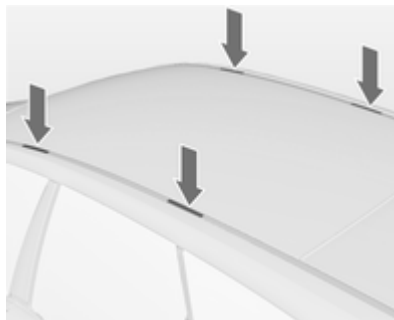

Detach the cover from each mounting point.

## Loading information



- Heavy objects in the load compartment should be placed against the seat backrests. Ensure that the backrests are securely engaged. If objects can be stacked, heavier objects should be placed at the bottom.
- Secure objects with lashing straps attached to the lashing eyes ⇨ 72.



- Use the hook at the left sidewall of the load compartment for hanging up carrier bags. Pull out the hook. Maximum load: 3 kg.
- Secure loose objects in the load compartment to prevent them from sliding.
- When transporting objects in the load compartment, the backrests of the rear seats must not be angled forward.
- Do not allow the load to protrude above the upper edge of the backrests.

- Do not place any objects on the load compartment cover or the instrument panel, and do not cover the sensor on top of the instrument panel.
- The load must not obstruct the operation of the pedals, parking brake and gear selector, or hinder the freedom of movement of the driver. Do not place any unsecured objects in the interior.
- Do not drive with an open load compartment.

### ⚠ Warning

Always make sure that the load in the vehicle is securely stowed. Otherwise objects can be thrown around inside the vehicle and cause personal injury or damage to the load or car.

- The payload is the difference between the permitted gross vehicle weight (see identification plate ⇨ 195) and the EC kerb weight.

To calculate the payload, enter the data for your vehicle in the Weights table at the front of this manual.

The EC kerb weight includes weights for the driver (68 kg), luggage (7 kg) and all fluids (tank 90 % full).

Optional equipment and accessories increase the kerb weight.

- Driving with a roof load increases the sensitivity of the vehicle to cross-winds and has a detrimental effect on vehicle handling due to the vehicle's higher centre of gravity. Distribute the load evenly and secure it properly with retaining straps. Adjust the tyre pressure and vehicle speed according to the load conditions. Check and retighten the straps frequently.

The permissible roof load is 60 kg. The roof load is the combined weight of the roof rack and the load.

## Instruments and controls

Controls .....	77
Warning lights, gauges and indicators .....	84
Information displays .....	94
Vehicle messages .....	98
Trip computer .....	102
Vehicle personalisation .....	103

### Controls

#### Steering wheel adjustment



Unlock lever, adjust steering wheel, then engage lever and ensure it is fully locked.

Do not adjust steering wheel unless vehicle is stationary and steering wheel lock has been released.

#### Steering wheel controls



The Infotainment system, the cruise control and a connected mobile phone can be operated via the controls on the steering wheel.

Further information is available in the Infotainment system manual.

Cruise control ⇨ 140.

## Heated steering wheel



Activate heating by pressing  button. Activation is indicated by the LED in the button.



The recommended grip areas of the steering wheel are heated quicker and to a higher temperature than the other areas.

Heating is operational when the engine is running and during an Autostop.

Stop-start system  128.

## Horn



Press .



## Windscreen wiper/washer

### Windscreen wiper



**2** = fast

**1** = slow

 = interval wiping

**O** = off

For a single wipe when the windscreen wiper is off, press the lever down.

Do not use if the windscreen is frozen.

Switch off in car washes.

### Adjustable wiper interval

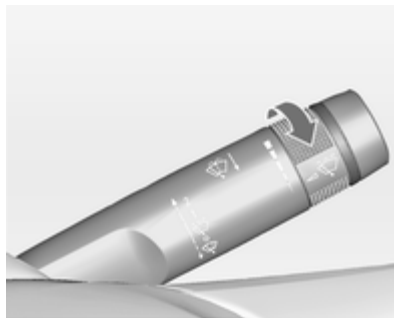

Wiper lever in position .

Turn the adjuster wheel to adjust the desired wipe interval:

short interval = turn adjuster wheel upwards

long interval = turn adjuster wheel downwards

### Automatic wiping with rain sensor

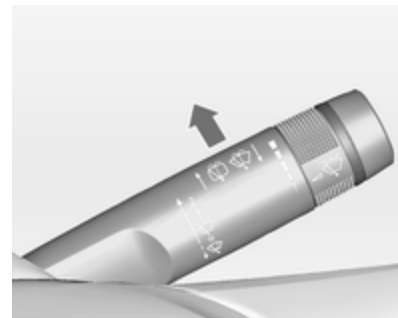

 = automatic wiping with rain sensor

The rain sensor detects the amount of water on the windscreen and automatically regulates the frequency of the windscreen wiper.

### Adjustable sensitivity of the rain sensor



Turn the adjuster wheel to adjust the sensitivity:

- |                  |   |                               |
|------------------|---|-------------------------------|
| low sensitivity  | = | turn adjuster wheel downwards |
| high sensitivity | = | turn adjuster wheel upwards   |

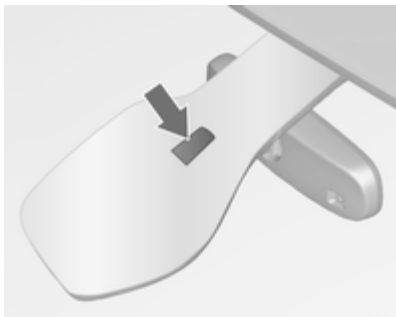

Keep the sensor free from dust, dirt and ice.

### Windscreen washer

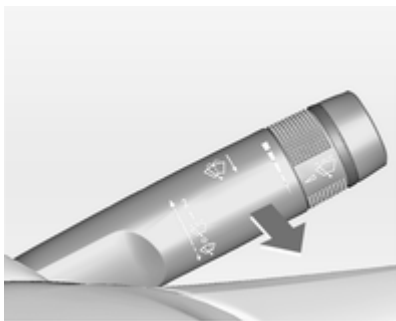

Pull lever. Washer fluid is sprayed onto the windscreen and the wiper wipes a few times.

### Rear window wiper/washer

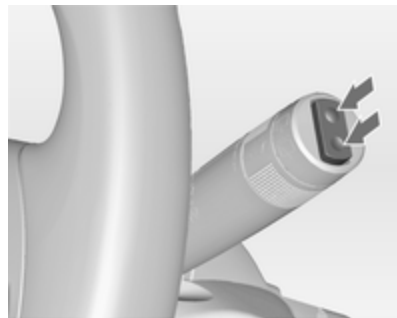

Press the rocker switch to activate the rear window wiper:

- |                 |   |                |
|-----------------|---|----------------|
| upper position  | = | short interval |
| lower position  | = | long interval  |
| middle position | = | off            |

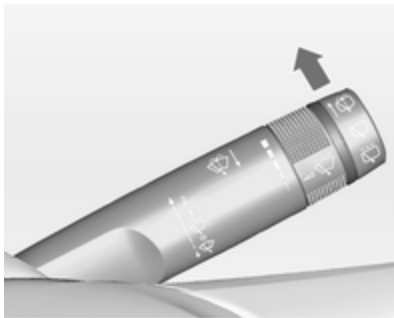

Push lever. Washer fluid is sprayed onto the rear window and the wiper wipes a few times.

Do not use if the windscreen is frozen. Switch off in car washes.

The rear window wiper comes on automatically when the windscreen wiper is switched on and reverse gear is engaged.

Activation or deactivation of this function can be changed in the menu **Settings** in the Info-Display.

Vehicle personalisation ⇨ 103.

## Outside temperature



20153

A drop in temperature is indicated immediately and a rise in temperature after a time delay.

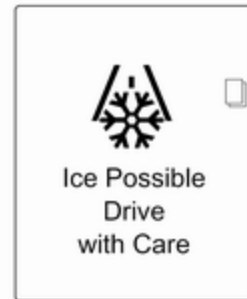

If outside temperature drops to 3 °C, a warning message is displayed in the Driver Information Centre with Uplevel-Display.

### **Warning**

The road surface may already be icy even though the display indicates a few degrees above 0 °C.

## Clock

Date and time are shown in the Info-Display.

### Set date and time

Press the **CONFIG** button. The menu **Settings** is displayed.

Select **Time & Date**.

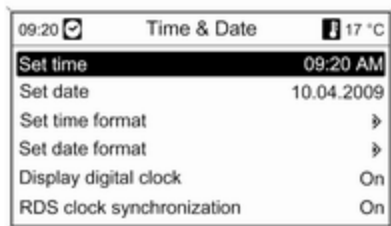

Selectable setting options:

- **Set time:** Changes the time shown on the display.
- **Set date:** Changes the date shown on the display.
- **Set time format:** Changes indication of hours between **12 hours** and **24 hours**.

- **Set date format:** Changes indication of date between **MM/DD/YYYY** and **DD.MM.YYYY**.
- **Display digital clock:** Switches on/off indication of time on the display.
- **RDS clock synchronization:** The RDS signal of most VHF transmitters automatically sets the time. RDS time synchronisation can take a few minutes. Some transmitters do not send a correct time signal. In such cases, it is recommended to switch off automatic time synchronisation.

Vehicle personalisation ⇨ 103.

### Power outlets



A 12 volt power outlet is located in the front console.



A further 12 volt power outlet is located in the rear console.

Do not exceed the maximum power consumption of 120 watts.

With ignition off, the power outlets are deactivated. Additionally the power outlets are deactivated in the event of low battery voltage.

Electrical accessories that are connected must comply with the electromagnetic compatibility requirements laid down in DIN VDE 40 839.

Do not connect any current-delivering accessories, e.g. electrical charging devices or batteries.

Do not damage the outlet by using unsuitable plugs.

Stop-start system ⇨ 128.

## Cigarette lighter



The cigarette lighter is located in the front console.

Press in cigarette lighter. It switches off automatically once the element is glowing. Pull out lighter.

## Ashtrays

Caution
To be used only for ash and not for combustible rubbish.



The portable ashtray can be placed in the cupholders.

## Warning lights, gauges and indicators

### Instrument cluster

In some versions, the needles of the instruments briefly rotate to the end position when the ignition is switched on.

### Speedometer

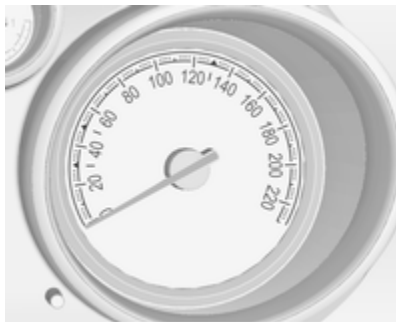

Indicates vehicle speed.

### Odometer



The bottom line displays the recorded distance in miles.

### Trip odometer

The top line displays the recorded distance since the last reset.

To reset, hold the reset knob depressed for a few seconds with the ignition on.

### Tachometer



Displays the engine speed.

Drive in a low engine speed range for each gear as much as possible.

#### Caution

If the needle is in the red warning zone, the maximum permitted engine speed is exceeded. Engine at risk.

## Fuel gauge



Displays the fuel level in the tank.

Control indicator ● illuminates if the level in the tank is low. Refuel immediately if it flashes.

Never run the tank dry.

Because of the fuel remaining in the tank, the top-up quantity may be less than the specified tank capacity.

## Engine coolant temperature gauge



Displays the coolant temperature.

left area = engine operating temperature not yet reached

central area = normal operating temperature

right area = temperature too high

### Caution

If engine coolant temperature is too high, stop vehicle, switch off engine. Danger to engine. Check coolant level.

## Service display

The engine oil life system lets you know when to change the engine oil and filter. Based on driving conditions, the interval at which an engine oil and filter change will be indicated can vary considerably.

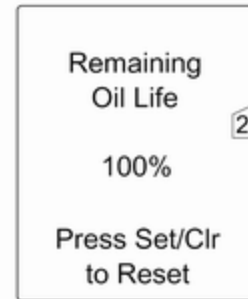

In the Uplevel-Display the remaining oil life duration is displayed in the **Vehicle Information Menu**.

In the Midlevel-Display the remaining engine oil life duration is displayed by the control indicator . The ignition must be switched on, with the engine not running.

The menu and function can be selected via the buttons on the turn signal lever.

To display the remaining engine oil life duration:



Press the **MENU** button to select the **Vehicle Information Menu**.

Turn the adjuster wheel to select **Remaining Oil Life**.

The system must be reset every time the engine oil is changed to allow proper functionality. Seek the assistance of a workshop.

Press the **SET/CLR** button to reset. The ignition must be switched on, with the engine not running.

When the system has calculated that engine oil life has been diminished, **Change Engine Oil Soon** or a warning code appears in the Driver Information Centre. Have engine oil and filter changed by a workshop within one week or 300 miles (whichever occurs first).

Driver Information Centre  94.

Service information  191.

## Control indicators

The control indicators described are not present in all vehicles. The description applies to all instrument versions.

Depending on the equipment the position of the control indicators may vary.

When the ignition is switched on, most control indicators will illuminate briefly as a functionality test.

The control indicator colours mean:

- |        |                               |
|--------|-------------------------------|
| red    | = danger, important reminder  |
| yellow | = warning, information, fault |
| green  | = confirmation of activation  |
| blue   | = confirmation of activation  |
| white  | = confirmation of activation  |



## Control indicators in the instrument cluster



## Control indicators in the centre console



### Turn signal

↔ illuminates or flashes green.

### Illuminates briefly

The parking lights are switched on.

### Flashes

A turn signal or the hazard warning flashers are activated.

Rapid flashing: failure of a turn signal light or associated fuse, failure of turn signal light on trailer.

Bulb replacement ↪ 157, Fuses ↪ 166.

Turn signals ↪ 112.

## Seat belt reminder

### Seat belt reminder on front seats

🚗 illuminates or flashes red.

### Illuminates

After the ignition has been switched on until the seat belt has been fastened.

### Flashes

After having started the engine for a maximum of 100 seconds until the seat belt has been fastened.

Fastening the seat belt ↪ 44.

### Seat belt status on rear seats

🚗 or 🚗 in the Driver Information Centre flashes or illuminates.

## Illuminates

After the ignition has been switched on for a minimum of 35 seconds until the seat belt has been fastened.

If an unfastened seat belt is fastened whilst driving.

## Flashes

After starting off when the seat belt is unfastened.

Fastening the seat belt ↪ 44.

## Airbag and belt tensioners

🚗 illuminates red.

When the ignition is switched on, the control indicator illuminates for approx. 4 seconds. If it does not illuminate, does not go out after 4 seconds or illuminates whilst driving, there is a fault in the airbag system. Seek the assistance of a workshop. The airbags and belt pretensioners may fail to trigger in the event of an accident.

Deployment of the belt pretensioners or airbags is indicated by continuous illumination of 🚗.

**⚠ Warning**

Have the cause of the fault remedied immediately by a workshop.

Belt pretensioners, airbag system  
 ⇨ 43, ⇨ 46.

**Airbag deactivation**

 illuminates yellow.

The front passenger airbag is activated.

 illuminates yellow.

The front passenger airbag is deactivated ⇨ 49.

**⚠ Danger**

Risk of fatal injury for a child using a child restraint system together with activated front passenger airbag.

Risk of fatal injury for an adult person with deactivated front passenger airbag.

**Charging system**

 illuminates red.

Illuminates when the ignition is switched on and goes out shortly after the engine starts.

**Illuminates when the engine is running**

Stop, switch off engine. Battery is not charging. Engine cooling may be interrupted. The brake servo unit may cease to be effective. Seek the assistance of a workshop.

**Malfunction indicator light**

 illuminates or flashes yellow.

Illuminates when the ignition is switched on and goes out shortly after the engine starts.

**Illuminates when the engine is running**

Fault in the emission control system. The permitted emission limits may be exceeded. Seek the assistance of a workshop immediately.

**Flashes when the engine is running**

Fault that could lead to catalytic converter damage. Ease up on the accelerator until the flashing stops. Seek the assistance of a workshop immediately.

**Service vehicle soon**

 illuminates yellow.

Additionally a warning message or a warning code is displayed.

The vehicle needs a service.

Seek the assistance of a workshop.

Vehicle messages ⇨ 98.

**Brake and clutch system****Brake and clutch fluid level**

 illuminates red.

The brake and clutch fluid level is too low ⇨ 154.

### Warning

Stop. Do not continue your journey. Consult a workshop.

### Operate pedal

 illuminates or flashes yellow.

### Illuminates

Brake pedal needs to be operated to release the electrical parking brake ↻ 137.

Clutch pedal needs to be operated to start the engine. Stop-start system ↻ 128.

### Flashes

Clutch pedal needs to be operated to start the engine ↻ 126.

### Electrical parking brake

 illuminates or flashes red.

### Illuminates

Electrical parking brake is applied ↻ 137.

### Flashes

Electrical parking brake is not fully applied or released. Switch on ignition, depress brake pedal and attempt to reset the system by first releasing and then applying the electrical parking brake. If  remains flashing, do not drive and seek the assistance of a workshop.

### Electrical parking brake fault

 illuminates or flashes yellow.

### Illuminates

Electrical parking brake is operating with degraded performance ↻ 137.

### Flashes

Electrical parking brake is in service mode. Stop vehicle, apply and release the electrical parking brake to reset.

### Warning

Have the cause of the fault remedied immediately by a workshop.

### Antilock brake system (ABS)

 illuminates yellow.

Illuminates for a few seconds after the ignition is switched on. The system is ready for operation when the control indicator goes out.

If the control indicator does not go out after a few seconds, or if it illuminates while driving, there is a fault in the ABS. The brake system remains operational but without ABS regulation.

Antilock brake system ↻ 136.

### Upshift

 illuminates green or is shown as a symbol in the Driver Information Centre with Uplevel-Display.

Upshifting is recommended for fuel saving.

## Variable effort steering

 illuminates yellow.

Fault in variable effort steering system. This may lead to a higher or lower steering effort. Consult a workshop.

Stop-start system ⇨ 128.

## Ultrasonic parking assist

 illuminates yellow.

Fault in system

or

Fault due to sensors that are dirty or covered by ice or snow

or

Interference due to external sources of ultrasound. Once the source of interference is removed, the system will operate normally.

Have the cause of the fault in the system remedied by a workshop.

Ultrasonic parking assist ⇨ 141.

## Electronic Stability Control off

 illuminates yellow.

The system is deactivated.

## Electronic Stability Control and Traction Control system

 illuminates or flashes yellow.

### Illuminates

A fault in the system is present. Continued driving is possible. Driving stability, however, may deteriorate depending on road surface conditions.

Have the cause of the fault remedied by a workshop.

### Flashes

The system is actively engaged. Engine output may be reduced and the vehicle may be braked automatically to a small degree.

Electronic Stability Control ⇨ 139,  
Traction Control system ⇨ 138.

## Traction Control system off

 illuminates yellow.

The system is deactivated.

## Preheating

 illuminates yellow.

Preheating is activated. Only activates when outside temperature is low.

## Diesel particle filter

 illuminates or flashes yellow.

The diesel particle filter requires cleaning.

Continue driving until  goes out. If possible do not allow engine speed to drop below 2000 rpm.

### Illuminates

The diesel particle filter is full. Start cleaning process as soon as possible.

### Flashes

The maximum filling level of the filter is reached. Start cleaning process immediately to avoid damage to the engine.

Diesel particle filter ↗ 130.

Stop-start system ↗ 128.

### Deflation detection system

⚠ illuminates or flashes yellow.

### Illuminates

Deflation detected. Stop immediately and check tyre pressure.

### Flashes

Fault in system. Consult a workshop.

Deflation detection system ↗ 174.

### Engine oil pressure

🛢 illuminates red.

Illuminates when the ignition is switched on and goes out shortly after the engine starts.

### Illuminates when the engine is running

#### Caution

Engine lubrication may be interrupted. This may result in damage to the engine and/or locking of the drive wheels.

1. Depress clutch.
2. Select neutral gear, set selector lever to **N**.
3. Move out of the flow of traffic as quickly as possible without impeding other vehicles.
4. Switch off ignition.

#### ⚠ Warning

When the engine is off, considerably more force is needed to brake and steer. During an Autostop the brake servo unit will still be operational.

Do not remove key until vehicle is stationary, otherwise the steering wheel lock could engage unexpectedly.

Check oil level before seeking assistance of a workshop ↗ 152.

### Low fuel

● illuminates or flashes yellow.

### Illuminates

Level in fuel tank is too low.

Additionally a warning message is displayed on vehicles with Uplevel-Display.

### Flashes

Fuel used up. Refuel immediately. Never run the tank dry.

Additionally a warning message is displayed on vehicles with Midlevel- and Uplevel-Display.

Catalytic converter ↗ 131.

Bleeding the diesel fuel system ↗ 156.

## Immobiliser

 flashes yellow.

Fault in the immobiliser system. The engine cannot be started.

## Reduced engine power

 illuminates yellow.

The engine power is limited. Consult a workshop.

## Exterior light

 illuminates green.

The exterior lights are on ⇨ 108.

## High beam

 illuminates blue.

Illuminated when high beam is on and during headlight flash ⇨ 109.

## Adaptive forward lighting

 illuminates or flashes yellow.

## Illuminates

Fault in system.

Seek the assistance of a workshop.

## Flashes

System switched to symmetrical low beam.

Control indicator  flashes for approx. 4 seconds after the ignition is switched on as a reminder that the system has been activated ⇨ 110.

Automatic light control ⇨ 109.

## Fog light

 illuminates green.

The front fog lights are on ⇨ 112.

## Rear fog light

 illuminates yellow.

The rear fog light is on ⇨ 112.

## Cruise control

 illuminates white or green.

## Illuminates white

The system is on.

## Illuminates green

A certain speed is stored.

Cruise control ⇨ 140.

## Door open

 illuminates red.

A door or the tailgate is open.

## Automatic locking

 illuminates amber.

Fault in the automatic locking system.

The rear doors are possibly not secured against opening.

### Warning

Stop your journey immediately! Follow the instructions as described in paragraph "Fault in the automatic locking system" before continuing your journey ⇨ 24.

Consult a workshop.

## Information displays

### Driver Information Centre



The Driver Information Centre (DIC) is located in the instrument cluster between speedometer and tachometer. It is available as Midlevel- or Uplevel-Display.



The following main menus, depending on the vehicle configuration, can be selected:

- **Vehicle Information Menu**
- **Trip/Fuel Information Menu**

Some of the displayed functions differ between vehicle driving and standstill and some functions are only active when the vehicle is driving.

Vehicle personalisation ⇨ 103,  
Memorised settings ⇨ 21.

### Selecting menus and functions

The menus and functions can be selected via the buttons on the turn signal lever.



Press the **MENU** button to switch between the menus or to return from a submenu to the next higher menu level.





Turn the adjuster wheel to highlight a menu option or to set a numeric value.



Press the **SET/CLR** button to select a function or to confirm a message.

### Vehicle Information Menu

Press the **MENU** button to select the **Vehicle Information Menu**.

Turn the adjuster wheel to select one of the submenus. Press the **SET/CLR** button to confirm.

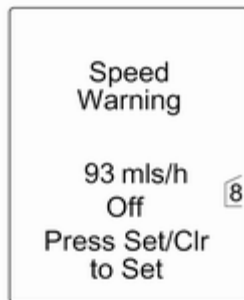

Follow the instructions given in the submenu.

Possible submenus:

- **Unit:** Displayed units can be changed

On vehicles with Midlevel-Display following settings can be selected:

- ◆ **Unit1:** Great Britain
- ◆ **Unit2:** United States
- ◆ **Unit3:** Europe
- **Remaining Oil Life:** ↻ 85
- **Speed Warning:** If exceeding the preset speed, a warning chime will be activated
- **Language:** Displayed language can be changed if the vehicle is not equipped with a radio

Selection and indication can be different between Midlevel- and Uplevel-Display.

### Trip/Fuel Information Menu

Press the **MENU** button to select the **Trip/Fuel Information Menu**.

Turn the adjuster wheel to select one of the submenus:

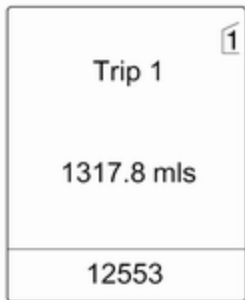

- Trip odometer 1
- Trip odometer 2
- Digital speed

Trip odometer 2 and digital speed are only available on vehicles with Uplevel-Display.

Selection and indication can be different between Midlevel- and Uplevel-Display.

On vehicles with trip computer more submenus are available.

Trip/Fuel Information Menu, Trip Computer ↪ 102.

## Graphic-Info-Display, Colour-Info-Display

Depending on the vehicle configuration the vehicle has a Graphic- or Colour-Info-Display. The Info-Display is located in the instrument panel above the Infotainment system.

### Graphic-Info-Display

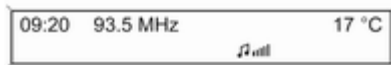

Depending on the Infotainment system, the Graphic-Info-Display is available in two versions.



20153

Graphic-Info-Display indicates:

- time ↪ 81
- outside temperature ↪ 81
- date ↪ 81
- Infotainment system, see description for Infotainment system in the Infotainment system manual
- settings for vehicle personalisation ↪ 103



**Press (the outer ring)**

- To select or activate the marked option
- To confirm a set value
- To switch a system function on/off

**BACK button**

Press button to:

- exit a menu without changing settings
- return from a submenu to a higher menu level
- delete the last character in a character sequence

Press and hold the button for a few seconds to delete the entire entry.

Vehicle personalisation ↗ 103,  
Memorised settings ↗ 21.

**Vehicle messages**

Messages are indicated mainly in the Driver Information Centre (DIC), in some cases together with a warning and signal buzzer.

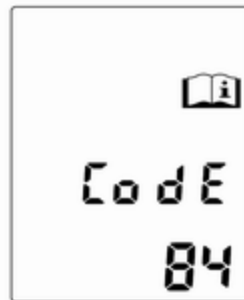

Press the **SET/CLR** button, the **MENU** button or turn the adjuster wheel to confirm a message.

**Vehicle messages on the Midlevel-Display**

The vehicle messages are displayed as code numbers.

**No. Vehicle message**

- 2 No radio remote control detected, depress clutch pedal for a restart
- 3 Engine coolant level low
- 4 Air conditioning off
- 5 Steering wheel is locked

**No. Vehicle message**

- 6 Depress brake pedal to release electrical parking brake
- 7 Turn steering wheel, switch ignition off and then on
- 9 Turn steering wheel, start engine again
- 12 Vehicle overloaded
- 13 Compressor overheated
- 15 Centre high-mounted brake light failure
- 16 Brake light failure
- 17 Headlight levelling malfunction
- 18 Left low beam failure
- 19 Rear fog light failure
- 20 Right low beam failure
- 21 Left sidelight failure
- 22 Right sidelight failure
- 23 Reversing light failure

**No. Vehicle message**

- 24 Number plate light failure
- 25 Left front turn signal failure
- 26 Left rear turn signal failure
- 27 Right front turn signal failure
- 28 Right rear turn signal failure
- 29 Check trailer brake light
- 30 Check trailer reversing light
- 31 Check left trailer turn signal
- 32 Check right trailer turn signal
- 33 Check trailer rear fog light
- 34 Check trailer rear light
- 35 Replace battery in radio remote control
- 48 Clean side blind zone alert system
- 50 Activated pedestrian protection system, reset bonnet
- 53 Tighten gas cap

**No. Vehicle message**

- 54 Water in diesel fuel filter
- 55 Diesel particle filter is full  
↻ 130
- 56 Tyre pressure imbalance on front axle
- 57 Tyre pressure imbalance on rear axle
- 58 Tyres without TPMS sensors detected
- 59 Open and then close driver window
- 60 Open and then close front passenger window
- 61 Open and then close rear left window
- 62 Open and then close rear right window
- 65 Theft attempted
- 66 Service theft alarm system
- 67 Service steering wheel lock

**No. Vehicle message**

- 68 Service power steering
- 69 Service suspension system
- 70 Service level control system
- 71 Service rear axle
- 74 Service AFL
- 75 Service air conditioning
- 76 Service side blind zone alert system
- 78 Service pedestrian protection system
- 79 Top up engine oil
- 81 Service transmission
- 82 Change engine oil soon
- 83 Service adaptive cruise control
- 84 Engine power is reduced
- 94 Shift to park before exiting
- 95 Service airbag

**No. Vehicle message**

- 128 Bonnet open
- 134 Park assist fault, clean bumper
- 136 Service parking assist
- 174 Low battery
- 258 Park assist off

**Vehicle messages on the Uplevel-Display**



The vehicle messages are displayed as text. Follow the instructions given in the messages.

The system displays messages regarding the following topics:

- Fluid levels
- Anti-theft alarm system
- Brakes
- Drive systems
- Ride control systems
- Cruise control
- Object detection systems
- Lighting, bulb replacement
- Wiper/washer system
- Doors, windows
- Radio remote control
- Seat belts
- Airbag systems
- Engine and transmission
- Tyre pressure
- Diesel particle filter

## Vehicle messages on the Colour-Info-Display

Some important messages appear additionally in the Colour-Info-Display. Press the multifunction knob to confirm a message. Some messages only pop up for a few seconds.

## Warning chimes

### When starting the engine or whilst driving

Only one warning chime will sound at a time.

The warning chime regarding not fastened seat belts has priority over any other warning chime.

- If seat belt is not fastened.
- If a door or the tailgate is not fully closed when starting off.
- If a certain speed is exceeded with parking brake applied.
- If a programmed speed is exceeded.

- If a warning message or a warning code appears in the Driver Information Centre.
- If the parking assist detects an object.
- If the reverse gear is engaged and the rear end carrier extended.
- If a fault in the automatic locking system is detected.
- If the diesel particle filter has reached the maximum filling level.

### When the vehicle is parked and/or the driver's door is opened

- When the key is in the ignition switch.
- With exterior lights on.

### During an Autostop

- If the driver's door is opened.

## Battery voltage

When the battery voltage is running low, a warning message or warning code 174 will appear in the Driver Information Centre.

1. Switch off immediately electrical consumers which are not required for a safe ride, such as seat heating, heated rear window or other main consumers.
2. Charge the battery by driving continuously for a while or by using a charging device.

The warning message or warning code will disappear after the engine has been started two times running without voltage drop.

If the battery cannot be recharged, have the cause of the fault remedied by a workshop.

## Trip computer

The menus and functions can be selected via the buttons on the turn signal lever.



Press the **MENU** button to select the **Trip/Fuel Information Menu**.



Turn the adjuster wheel to select one of the submenus:

- Trip odometer 1
- Trip odometer 2
- Range
- Average consumption
- Instantaneous consumption
- Average speed
- Digital speed

Trip odometer 2 and digital speed are only available on vehicles with Uplevel-Display.



The information of the two trip computers can be reset separately, making it possible to display different trip distances.

To reset, press the **reset knob** or press the **SET/CLR** button for a few seconds.





## Range

Range is calculated from current fuel tank content and current consumption. The display shows average values.

After refuelling, the range is updated automatically after a brief delay.

When the fuel level in the tank is low, a message appears on vehicles with Uplevel-Display.

When the tank has to be refueled immediately, a warning code or warning message is displayed on vehicles with Midlevel- and Uplevel-Display.

Additionally the control indicator ● in the fuel gauge illuminates or flashes ⇨ 92.

## Average consumption

Display of average consumption. The measurement can be reset at any time and starts with a default value.

To reset, press the **SET/CLR** button for a few seconds.

## Instantaneous consumption

Display of the instantaneous consumption.

## Average speed

Display of average speed. The measurement can be reset at any time.

To reset, press the **SET/CLR** button for a few seconds.

## Digital speed

Digital display of the instantaneous speed.

## Vehicle personalisation

The vehicle's behaviour can be personalised by changing the settings in the Info-Display.

Some of the personal settings for different drivers can be memorised individually for each vehicle key. Memorised settings ⇨ 21.

Depending on vehicle equipment and country-specific regulations some of the functions described below might not be available.

Some functions are only displayed or active when the engine is running.

## Personal settings in the Graphic-Info-Display



Press the **CONFIG** button. The menu **Settings** is displayed.

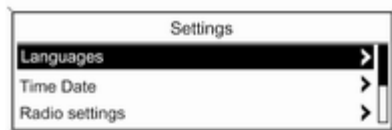

The following settings can be selected by turning and pressing the multifunction knob:

- **Languages**
- **Time Date**
- **Radio settings**
- **Phone settings**
- **Vehicle settings**

In the corresponding submenus the following settings can be changed:

### **Languages**

Selection of the desired language.

### **Time Date**

See Clock ⇨ 81.

### **Radio settings**

See description for Infotainment system in the Infotainment system manual.

### **Phone settings**

See description for Infotainment system in the Infotainment system manual.

## Vehicle settings

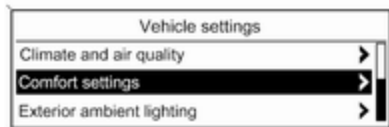

### ■ Climate and air quality

**Auto fan speed:** Modifies the fan regulation.

**Climate control mode:** Activate or deactivate cooling.

**Auto rear demist:** Automatic activation of rear heated window.

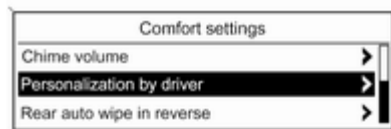

20340

### ■ Comfort settings

**Chime volume:** Change the volume of warning chimes.

**Personalization by driver:** Activate or deactivate the personalisation function.

**Rear auto wipe in reverse:** Activate or deactivate automatic switching on of the rear window wiper when reverse gear is engaged.

### ■ Park assist / Collision detection

**Park assist:** Activate or deactivate the ultrasonic parking assist .

### ■ Exterior ambient lighting

**Duration upon exit of vehicle:** Activate or deactivate and change the duration of exit lighting.

**Exterior lighting by unlocking:** Activate or deactivate the welcome lighting.

### ■ Remote locking, unlocking, starting

**Remote door unlock:** Change the configuration to unlock only the driver's door or the whole vehicle whilst unlocking.

### ■ Restore factory settings

**Restore factory settings:** Reset all settings to the default settings.

## Personal settings in the Colour-Info-Display



Press the **CONFIG** button. The menu **Settings** is displayed.

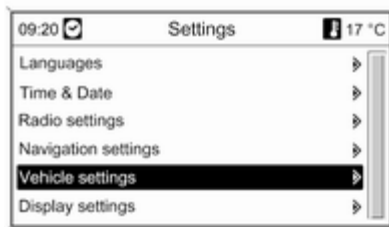

The following settings can be selected by turning and pressing the multifunction knob:

- **Languages**
- **Time & Date**
- **Radio settings**
- **Phone settings**
- **Navigation settings**
- **Vehicle settings**
- **Display settings**

In the corresponding submenus the following settings can be changed:

### Languages

Selection of the desired language.

### Time & Date

See Clock ↻ 81.

### Radio settings

See description for Infotainment system in the Infotainment system manual.

### Phone settings

See description for Infotainment system in the Infotainment system manual.

### Navigation settings

See description for Infotainment system in the Infotainment system manual.

### Vehicle settings

#### ■ Climate and air quality

**Auto fan speed:** Modifies the fan regulation.

**Climate control mode:** Activate or deactivate cooling.

**Auto rear demist:** Automatic activation of rear heated window.

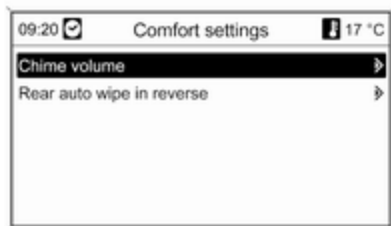

#### ■ Comfort settings

**Chime volume:** Change the volume of warning chimes.

**Rear auto wipe in reverse:** Activate or deactivate automatic switching on of the rear window wiper when reverse gear is engaged.

#### ■ Park assist / Collision detection

**Park assist:** Activate or deactivate the ultrasonic parking assist.

#### ■ Exterior ambient lighting

**Duration upon exit of vehicle:** Activate or deactivate and change the duration of exit lighting.

#### Exterior lighting by unlocking:

Activate or deactivate the welcome lighting.

#### ■ Restore factory settings

**Restore factory settings:** Reset all settings to the default settings.

#### Display settings

Selectable display settings:

- **Day mode:** Optimisation for daylight conditions.
- **Night mode:** Optimisation for darkness.
- **Automatic mode:**

Vehicles without light sensor:

The display changes the mode when the vehicle lights are switched on/off.

Vehicles with light sensor:

The display changes the mode due to the exterior lighting conditions independently from the vehicle lights.

## Lighting

Exterior lighting ..... 108  
 Interior lighting ..... 113  
 Lighting features ..... 115

## Exterior lighting

### Light switch



Turn light switch:

- AUTO** = automatic light control:  
Headlights are switched on and off automatically depending on external lighting conditions.
- ☺ = activation or deactivation of the automatic light control. Switch turns back to **AUTO**.
- ☞☞ = sidelights
- ☞☞☞ = headlights

Vehicles without automatic light control:

○ = off

In the Driver Information Centre with Uplevel-Display, the current status of the automatic light control is displayed.

When switching on the ignition, automatic light control is active.

Control indicator ☞☞☞ 93.

### Tail lights

Tail lights are illuminated together with headlights and sidelights.

## Automatic light control



When the automatic light control function is switched on and the engine is running, the system switches between daytime running light and headlight depending on the lighting conditions.

## Daytime running light

Daytime running light increases visibility of the vehicle during daylight.

While the daytime running light is active, the tail lights are switched on or off depending on country-specific variant.

## Automatic headlight activation

During poor lighting conditions the headlights are switched on.

## Tunnel detection

When a tunnel is entered the headlights are switched on. Adaptive forward lighting ⇨ 111.

## High beam



To switch from low to high beam, push lever.

To switch to low beam, push lever again or pull.

## Headlight flash

To activate the headlight flash, pull lever.

## Headlight range adjustment

### Manual headlight range adjustment



To adapt headlight range to the vehicle load to prevent dazzling: turn thumb wheel ⇨ to required position.

- 0 = front seats occupied
- 1 = all seats occupied
- 2 = all seats occupied and load compartment laden
- 3 = driver's seat occupied and load compartment laden.

## Headlights when driving abroad

The asymmetrical headlight beam extends visibility at the edge of the road at the passenger side.

However, when driving in countries where traffic drives on the opposite side of the road, adjust the headlights to prevent dazzling of oncoming traffic.

## Vehicles without Adaptive Forward Lighting



Turn the adjusting screws with the screwdriver clockwise for half a turn. The adjusting screws are located at the headlights above the low beam caps ⇨ 157.

For deactivation turn the adjusting screws anticlockwise for half a turn.

## Caution

Have the adjustment of the headlights checked after deactivation.

We recommend consulting a workshop.

## Vehicles with Adaptive Forward Lighting

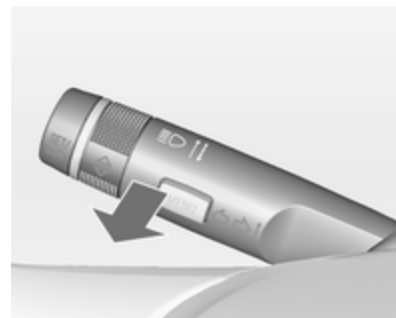



1. Key in ignition switch.
2. Pull turn signal lever and hold (headlight flash).



3. Switch on ignition.
4. After approx. 5 seconds the control indicator  starts flashing and an acoustic signal sounds.

Control indicator  ⇨ 93.

Every time the ignition is switched on,  flashes as a reminder for approx. 4 seconds.

For deactivation operate the same procedure as described above.  will not flash when function is deactivated.

## Adaptive forward lighting

Adaptive forward lighting ensures better illumination of bends, crossings and narrow bends.

## Curve lighting



The light beam pivots based on steering wheel position and speed.

## Corner lighting

On tight bends or when turning off, depending on the steering angle or the indicator light signal, an additional left or right reflector is switched on which illuminates the road in the direction of travel. It is activated up to a speed of 25 mph.

## Reversing function

If the headlights are on and reverse gear is engaged, both corner lights are switched on. They remain illuminated for 20 seconds after disengaging reverse gear or until driving faster than 10 mph forward.

## Hazard warning flashers



Operated with the  button.

In the event of an accident with airbag deployment the hazard warning flashers are activated automatically.

## Turn and lane-change signals

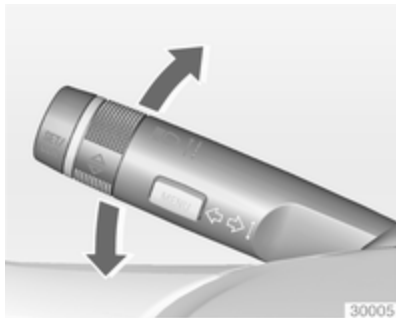

lever up = right turn signal  
 lever down = left turn signal

If the lever is moved past the resistance point, the turn signal is switched on constantly. When the steering wheel moves back, the turn signal is automatically deactivated.

For three flashes, e.g. when changing lanes, press the lever until resistance is felt and then release.

With a trailer connected, turn signal flashes six times when pressing the lever until resistance is felt and then releasing.

Move the lever to the resistance point and hold for longer indication.

Switch the turn signal off manually by moving the lever to its original position.

## Front fog lights



Operated with the  $\text{D}$  button.

Light switch in position **AUTO**: switching on front fog lights will switch headlights on automatically.

## Rear fog lights



Operated with the  $\text{D}$  button.

Light switch in position **AUTO**: switching on rear fog light will switch headlights on automatically.

Light switch in position  $\text{D}$ : rear fog light can only be switched on with front fog lights.

The vehicle rear fog light is deactivated when towing.

## Parking lights



When the vehicle is parked, the parking lights on one side can be activated:

1. Switch off ignition.
2. Move turn signal lever all the way up (right parking lights) or down (left parking lights).

Confirmed by a signal and the corresponding turn signal control indicator.

## Reversing lights

The reversing light comes on when the ignition is on and reverse gear is selected.

## Misted light covers

The inside of the light housing may mist up briefly in poor, wet and cold weather conditions, in heavy rain or after washing. The mist disappears quickly by itself; to help switch on the headlights.

## Interior lighting

### Instrument panel illumination control



Brightness of the following lights can be adjusted when the exterior lights are on:

- Instrument panel illumination
- Info-Display
- Illuminated switches and operation elements

Turn thumb wheel  until the required brightness is obtained.

On vehicles with light sensor the brightness can only be adjusted when the exterior lights are on and the light sensor detects night conditions.

## Interior lights

During entry and exit of the vehicle, the front and rear courtesy lights automatically switch on and then off after a delay.

### Notice

In the event of an accident with airbag deployment the courtesy lights are turned on automatically.

## Front courtesy light



Operate rocker switch:

 = automatic switching on and off.

press  = on.

press  = off.

## Rear courtesy lights



Illuminate in conjunction with the front courtesy light depending on rocker switch position.

## Reading lights



Operated with  and  buttons in front and rear courtesy lights.

## Sunvisor lights

Illuminate when the cover is opened.

## Lighting features

### Centre console lighting

Spotlight incorporated in the interior lighting comes on when headlights are switched on.

### Entry lighting

#### Welcome lighting

Headlights, tail lights, reversing lights, number plate lights, instrument panel light and interior lights are switched on for a short time by pressing the unlocking button  on the radio remote control twice. This function works only in the dark and facilitates locating the vehicle.

The lighting switches off immediately when the ignition key is turned to position 1  126.

Activation or deactivation of this function can be changed in the menu **Settings** in the Info-Display. Vehicle personalisation  103.

The settings can be saved for the key being used  21.

The following lights will additionally switch on when the driver's door is opened:

- All switches
- Driver Information Centre

### Exit lighting

The following lights switch on if the key is removed from the ignition switch:

- Interior lights
- Instrument panel light (only when it is dark)

They will switch off automatically after a delay. Both lightings will be activated again if the driver's door is opened.

The puddle light illuminates when the according door is opened.

Headlights, tail lights, reversing lights and number plate lights illuminate the surrounding area for an adjustable time after leaving the vehicle.

### Switching on



1. Switch off ignition.
2. Remove ignition key.
3. Open driver's door.
4. Pull turn signal lever.
5. Close driver's door.

If the driver's door is not closed the lights switch off after 2 minutes.

Exit lighting is switched off immediately if the turn signal lever is pulled while the driver's door is open.

Activation, deactivation and duration of this function can be changed in the menu **Settings** in the Info-Display. Vehicle personalisation ↻ 103.

The settings can be saved for the key being used ↻ 21.

### **Battery discharge protection**

#### **Switching off electric lights**

To prevent discharge of the battery when the ignition is switched off, some interior lights are switched off automatically after some time.

## Climate control

Climate control systems .....	117
Air vents .....	123
Maintenance .....	123

## Climate control systems

### Heating and ventilation system



Controls for:

- Temperature
- Air distribution
- Fan speed
- Demisting and defrosting

Heated rear window  → 32.



### Temperature

red = warm

blue = cold

Heating will not be fully effective until the engine has reached normal operating temperature.

### Air distribution



-  = to windscreen and front door windows
-  = to head area via adjustable air vents
-  = to foot well

All combinations are possible.

### Fan speed

Adjust the air flow by switching the fan to the desired speed.

### Demisting and defrosting

- Press button : fan automatically switches to higher speed, the air distribution is directed towards the windscreen.
- Set temperature control to warmest level.
- Switch on heated rear window .
- Open side air vents as required and direct them towards the door windows.



**Notice**

If the settings for demisting and defrosting are selected, an Autostop will be inhibited.

If the settings for demisting and defrosting are selected while the engine is in an Autostop, the engine will restart automatically.

**Air conditioning system**

In addition to the heating and ventilation system, the air conditioning system has:

-  = cooling
-  = air recirculation

Heated seats  40, Heated steering wheel  78.

**Cooling** 

Operated with the  button and is functional only when the engine and fan are running.

The air conditioning system cools and dehumidifies (dries) as soon as the outside temperature is slightly above the freezing point. Therefore condensation may form and drip from under the vehicle.

If no cooling or drying is required, switch the cooling system off to save fuel. When the cooling system is switched off, no engine restart will be requested by the climate control system during an Autostop.

**Air recirculation system** 

Operated with the  button.



**Warning**

The exchange of fresh air is reduced in air recirculation mode. In operation without cooling the air humidity increases, so the windows may mist up from inside. The quality of the passenger compartment air deteriorates, which may cause the vehicle occupants to feel drowsy.

In warm and very humid ambient air conditions, the windscreen might mist up from outside, when cold air is directed to it. If windscreen mists up from outside, activate windscreen wiper and deactivate .

**Maximum cooling**

Briefly open the windows so that hot air can disperse quickly.



- Cooling  on.
- Air circulation system  on.
- Press air distribution switch .
- Set temperature control to coldest level.



- Set fan speed to highest level.
- Open all vents.

### Demisting and defrosting the windows



- Press button : fan automatically switches to higher speed, the air distribution is directed towards the windscreen.
- Switch cooling  on.
- Set temperature control to warmest level.

- Switch on heated rear window .
- Open side air vents as required and direct them towards the door windows.

#### Notice

If the settings for demisting and defrosting are selected, an Autostop will be inhibited.

If the settings for demisting and defrosting are selected while the engine is in an Autostop, the engine will restart automatically.

### Electronic climate control system

The dual zone climate control allows different climatisation temperatures for driver and front passenger side.



Controls for:

- Temperature on driver side
- Air distribution
- Fan speed
- Temperature on front passenger side

**AUTO** = automatic mode

 = manual air recirculation

 = demisting and defrosting

Heated rear window  ↗ 32.

The preselected temperature is automatically regulated. In the automatic mode the fan speed and air distribution automatically regulate the air flow.

The system can be manually adapted via the use of air distribution and air flow controls.

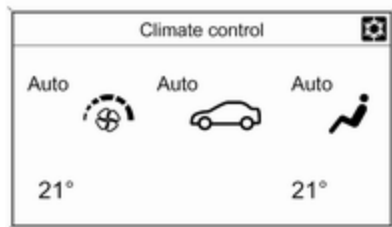

Each change of settings is shown in the Info-Display for a few seconds.

The electronic climate control system is only fully operational when the engine is running.

## Automatic mode AUTO



Basic setting for maximum comfort:

- Press **AUTO** button, the air conditioning is activated automatically.
- Open all air vents.
- Set the preselected temperatures for driver and front passenger using the left and right rotary knob.
- Recommended comfort setting is 22 °C.

The fan speed regulation in automatic mode can be changed in the menu **Settings**.

Vehicle personalisation ⇨ 103.

All air vents are actuated automatically in automatic mode. The air vents should therefore always be open.

## Temperature preselection

Temperatures can be set to the desired value.



If the minimum temperature is set, the climate control system runs at maximum cooling.

If the maximum temperature is set, the climate control system runs at maximum heating.





**Notice**

If the temperature is set to **Lo** or **Hi**, an Autostop will be inhibited.



If the temperature is set to **Lo** or **Hi** while the engine is in an Autostop, the engine will restart automatically.

Stop-start system ↗ 128.

**Demisting and defrosting the windows** 

- Press button .
- Press cooling button .
- Temperature and air distribution are set automatically and the fan runs at high speed.
- Switch on heated rear window .
- To return to previous mode: press button .

**Notice**

If the  button is pressed with fan switched on while the engine is running, an Autostop will be inhibited until the  button is pressed again.



If the  button is pressed with fan switched on while the engine is in an Autostop, the engine will restart automatically.

**Manual settings**

Climate control system settings can be changed by activating the buttons and rotary knobs as follows.

Changing a setting will deactivate the automatic mode.





Press lower button  to decrease or upper button  to increase fan speed. The fan speed is indicated by the number of segments in the display.

Pressing the lower button longer, fan and cooling are switched off.

Pressing the upper button longer, the fan runs at maximum speed.

To return to automatic mode: Press **AUTO** button.

**Air distribution**

Press ,  or  for desired adjustment. Activation is indicated by the LED in the button.

 = to windscreen and front door windows

 = to head area via adjustable air vents

 = to foot well

All combinations are possible.

Return to automatic air distribution: Deactivate corresponding setting or press button **AUTO**.

**Cooling**

Activate or deactivate with the  button.

The air conditioning system cools and dehumidifies (dries) when outside temperature is above a specific level. Therefore condensation may form and drip from under the vehicle.

If no cooling or drying is required, switch the cooling system off to save fuel. When the cooling system is switched off, no engine restart will be requested by the climate control system during an Autostop.

Depending on the vehicle equipment, the display will indicate **AC** when cooling is activated or **Eco** when the cooling is deactivated.

### Air recirculation mode

#### ⚠ Warning

The exchange of fresh air is reduced in air recirculation mode. In operation without cooling the air humidity increases, so the windows may mist up from inside. The quality of the passenger compartment air deteriorates, which may cause the vehicle occupants to feel drowsy.

In warm and very humid ambient air conditions, the windscreen might mist up from outside, when cold air is

directed to it. If windscreen mists up from outside, activate windscreen wiper and deactivate .



Press button  once to activate the manual air recirculation mode.

Activation is indicated by the LED in the button.

### Basic settings

Some settings can be changed in the menu **Settings** in the Info-Display. Vehicle personalisation  103.

## Auxiliary heater

### Air heater

Quickheat is an electric auxiliary air heater which automatically warms up the passenger compartment more quickly.

## Air vents

### Adjustable air vents



To open the vent, turn the adjuster wheel to the right. Adjust the air amount at the vent outlet by turning the adjuster wheel.

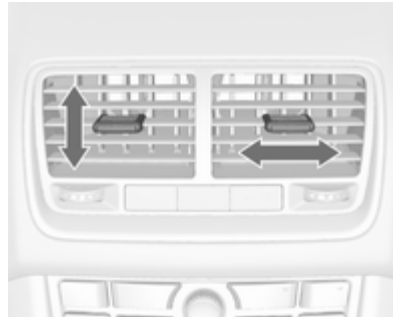

Direct the flow of air by tilting and swivelling the slats.

To close the vent, turn the adjuster wheel to the left.

### Warning

Do not attach any objects to the slats of the air vents. Risk of damage and injury in case of an accident.

### Fixed air vents

Additional air vents are located beneath the windscreen and door windows and in the foot wells.

## Maintenance

### Air intake

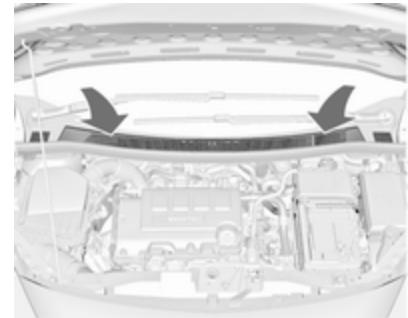

The air intake in front of the windscreen in the engine compartment must be kept clear to allow air intake. Remove any leaves, dirt or snow.

### Pollen filter

#### Cabin air filtration

A particle filter cleans the cabin air from dust, soot, pollen and spores.

### **Active carbon filter**

In addition to the particle filter the active carbon filter reduces odours.

### **Air conditioning regular operation**

In order to ensure continuously efficient performance, cooling must be operated for a few minutes once a month, irrespective of the weather and time of year. Operation with cooling is not possible when the outside temperature is too low.

### **Service**

For optimal cooling performance, it is recommended to annually check the climate control system, starting 3 years after initial vehicle registration, including:

- Functionality and pressure test
- Heating functionality
- Leakage check
- Check of drive belts

- Cleaning of condenser and evaporator drainage
- Performance check

## Driving and operating

Driving hints .....	125
Starting and operating .....	126
Engine exhaust .....	130
Automatic transmission .....	132
Manual transmission .....	135
Brakes .....	136
Ride control systems .....	138
Cruise control .....	140
Object detection systems .....	141
Fuel .....	143
Towing .....	146

## Driving hints

### Control of the vehicle

#### **Never coast with engine not running (except during Autostop)**

Many systems will not function in this situation (e.g. brake servo unit, power steering). Driving in this manner is a danger to yourself and others. All systems function during an Autostop, but there will be a controlled reduction in power steering assist and vehicle speed is reduced.

Stop-start system ⇨ 128.

#### **Idle boost**

If charging of the battery is required due to battery condition, the power output of the generator has to be increased. This will be achieved by an idle boost which may be audible.

On vehicles with Uplevel-Display, a message appears in the Driver Information Centre.

## Pedals

To ensure the pedal travel is uninhibited, there must be no mats in the area of the pedals.

## Starting and operating

### New vehicle running-in

Do not brake unnecessarily hard for the first few journeys.

During the first drive, smoke may occur because of wax and oil evaporating off the exhaust system. Park the vehicle in the open for a while after the first drive and avoid inhaling the fumes.

During the running-in period fuel and engine oil consumption may be higher and the cleaning process of the diesel particle filter may take place more often. Autostop may be inhibited to allow for charging the battery.

Diesel particle filter ⇨ 130.

### Ignition switch positions

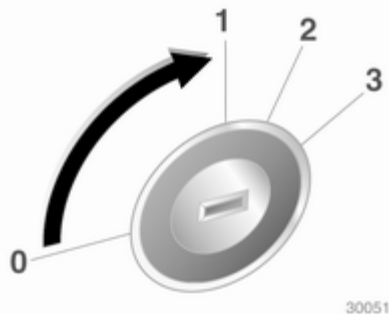

- 0 = Ignition off
- 1 = Steering wheel lock released, ignition off
- 2 = Ignition on, for diesel engine: preheating
- 3 = Starting

### Retained power off

The following electronic systems can work until the driver's door is opened or at the latest for 10 minutes after the ignition is switched off:

- Power windows
- Power outlets

Power to the Infotainment system will continue to operate for 30 minutes or until the key is removed from the ignition, regardless of whether any door will be opened.

### Starting the engine

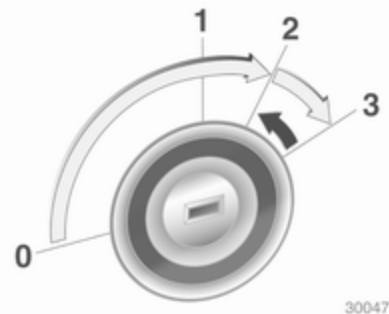

Manual transmission: operate clutch.  
Automatic transmission: operate brake and move the selector lever to **P** or **N**.

Do not operate accelerator pedal.



Diesel engine: turn the key to position **2** for preheating until control indicator  goes out.

Turn the key briefly to position **3** and release: an automatic procedure operates the starter with a short delay as long as the engine is running, see Automatic Starter Control.

Before restarting or to switch off the engine, turn the key back to position **0**.

During an Autostop, the engine can be started by depressing the clutch pedal.

### Starting the vehicle at low temperatures

The start of the engine without additional heaters is possible down to  $-25\text{ }^{\circ}\text{C}$  for diesel engines and  $-30\text{ }^{\circ}\text{C}$  for petrol engines. Required is an engine oil with the correct viscosity, the correct fuel, performed services and a sufficiently charged battery. With temperatures below  $-30\text{ }^{\circ}\text{C}$  the automatic transmission need a warming phase of approx. 5 minutes. The selector lever must be in position **P**.

### Automatic Starter Control

This function controls the engine starting procedure. The driver does not have to hold the key in position **3**. Once applied, the system will go on starting automatically until the engine is running. Because of the checking procedure, the engine starts running after a short delay.

Possible reasons for a non-starting engine:

- Clutch pedal not operated (manual transmission)
- Brake pedal not operated or selector lever not in **P** or **N** (automatic transmission)
- Timeout occurred

### Turbo engine warm-up

Upon start-up, engine available torque may be limited for a short time, especially when the engine temperature is cold. The limitation is to allow the lubrication system to fully protect the engine.

### Overrun cut-off

The fuel supply is automatically cut off during overrun, i.e. when the vehicle is driven with a gear engaged but accelerator is released.

## Stop-start system

The stop-start system helps to save fuel and to reduce the exhaust emissions. When conditions allow, it switches off the engine as soon as the vehicle is at a low speed or at a standstill, e.g. at a traffic light or in a traffic jam. It starts the engine automatically as soon as the clutch is depressed. A battery sensor ensures that an Autostop is only performed if the battery is sufficiently charged for a restart.

### Activation

The stop-start system is available as soon as the engine is started, the vehicle starts-off and the conditions as stated below in this section are fulfilled.

### Deactivation



Deactivate the stop-start system manually by pressing the **eco** button. The deactivation is indicated by the LED in the button going off.

### Autostop

If the vehicle is at a low speed or at a standstill, activate an Autostop as follows:

- Depress the clutch pedal
- set the lever in neutral
- release the clutch pedal

The engine will be switched off while the ignition stays on.



An Autostop is indicated by the needle at the **AUTOSTOP** position in the tachometer.

During an Autostop, the heating and brake performance will be maintained. The steering assist will be reduced during an Autostop.

### Conditions for an Autostop

The stop-start system checks if each of the following conditions is fulfilled. Otherwise an Autostop will be inhibited.

- The stop-start system is not manually deactivated
- the bonnet is fully closed

- the driver's door is closed or the driver's seat belt is fastened
- the battery is sufficiently charged and in good condition
- the engine is warmed up
- the engine coolant temperature is not too high
- the engine exhaust temperature is not too high, e.g. after driving with high engine load
- the ambient temperature is not too low
- the defrost selection does not inhibit an Autostop
- the climate control system does not inhibit an Autostop
- the brake vacuum is sufficient
- the self-cleaning function of the diesel particle filter is not active
- the vehicle has moved since the last Autostop

An Autostop may become less available as the ambient temperature approaches the freezing point.

Certain settings of the climate control system may inhibit an Autostop. See climate control chapter for more details.

Immediately after motorway driving an Autostop may be inhibited.

New vehicle running-in ⇨ 126.

### **Battery discharge protection**

To ensure reliable engine restarts, several battery discharge protection features are implemented as part of the stop-start system.

### **Power saving measures**

During an Autostop, several electrical features such as auxiliary electric heater or rear window heating are disabled or switched into a power saving mode. The fan speed of the climate control system is reduced to save power.

### **Restart of the engine by the driver**

Depress the clutch pedal to restart the engine.

The engine start is indicated by the needle at the idle speed position in the tachometer.

If the selector lever is shifted out of neutral before depressing the clutch first, control indicator  illuminates or is shown as a symbol in the Driver Information Center.

Control indicator  ⇨ 89.

### **Restart of the engine by the stop-start system**

The lever has to be in neutral to enable an automatic restart.

If one of the following conditions occurs during an Autostop, the engine will be restarted automatically by the stop-start system.

- The stop-start system is manually deactivated
- the bonnet is opened
- the driver's seat belt is unfastened and the driver's door is opened
- the engine temperature is too low
- the battery is discharged
- the brake vacuum is not sufficient

- the vehicle starts to move
- the climate control system requests an engine start
- the air conditioning is manually switched on

If the bonnet is not fully closed, a warning message is displayed in the Driver Information Centre.

If an electrical accessory, e.g. a portable CD player, is connected to the power outlet, a brief power drop during restart might be noticeable.

## Parking

- Do not park the vehicle on an easily ignitable surface. The high temperature of the exhaust system could ignite the surface.
- Always apply parking brake. Pull switch (P).
- Switch off the engine and ignition. Turn the steering wheel until the steering wheel lock engages.
- If the vehicle is on a level surface or uphill slope, engage first gear or set the selector lever to **P** before

switching off the ignition. On an uphill slope, turn the front wheels away from the kerb.

If the vehicle is on a downhill slope, engage reverse gear or set the selector lever to **P** before switching off the ignition. Turn the front wheels towards the kerb.

- Lock the vehicle and activate the anti-theft alarm system.

### Notice

In the event of an accident with airbag deployment, the engine is turned off automatically if the vehicle comes to a standstill within a certain time.

## Engine exhaust

### Danger

Engine exhaust gases contain poisonous carbon monoxide, which is colourless and odourless and could be fatal if inhaled.

If exhaust gases enter the interior of the vehicle, open the windows. Have the cause of the fault rectified by a workshop.

Avoid driving with an open load compartment, otherwise exhaust gases could enter the vehicle.

## Diesel particle filter

The diesel particle filter system filters harmful soot particles out of the exhaust gases. The system includes a self-cleaning function that runs automatically during driving without any notification. The filter is cleaned by periodically burning off the soot particles at high temperature. This process takes place automatically under set driving conditions and may

take up to 25 minutes. Typically it needs between 7 and 12 minutes. Autostop is not available and fuel consumption may be higher during this period. The emission of smells and smoke during this process is normal.



Under certain driving conditions, e.g. short distances, the system cannot clean itself automatically.

If the cleaning of the filter is required and if previous driving conditions did not enable automatic cleaning, it will be indicated by the control indicator . Simultaneously **Diesel partic. filter**

**is full continue driving** or warning code 55 appears in the Driver Information Centre.

 illuminates when diesel particle filter is full. Start cleaning process as soon as possible.

 flashes when diesel particle filter has reached the maximum filling level. Start cleaning process immediately to avoid damage to the engine.

### Cleaning process

To activate cleaning process, continue driving, keeping engine speed above 2000 revolutions per minute. Shift down if necessary. Diesel particle filter cleaning is then started.

If  illuminates additionally, cleaning is not possible, seek the assistance of a workshop.

### Caution

If the cleaning process is interrupted, there is a risk of provoking severe engine damage.



Cleaning takes place quickest at high engine speeds and loads.

The control indicator  extinguishes as soon as the self-cleaning operation is complete.

## Catalytic converter

The catalytic converter reduces the amount of harmful substances in the exhaust gases.

### Caution

Fuel grades other than those listed on pages  143,  199 could damage the catalytic converter or electronic components.

Unburnt petrol will overheat and damage the catalytic converter. Therefore avoid excessive use of the starter, running the fuel tank dry and starting the engine by pushing or towing.

In the event of misfiring, uneven engine running, a reduction in engine performance or other unusual problems, have the cause of the fault

rectified by a workshop as soon as possible. In an emergency, driving can be continued for a short period, keeping vehicle speed and engine speed low.

## Automatic transmission

The automatic transmission permits automatic gearshifting (automatic mode) or manual gearshifting (manual mode).

## Transmission display

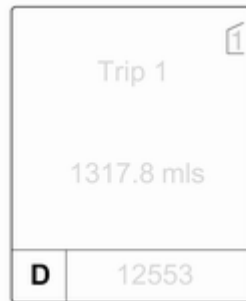

The mode or selected gear is shown in the transmission display.

## Selector lever



- P** = park position, wheels are locked, engage only when the vehicle is stationary and the parking brake is applied
- R** = reverse gear, engage only when the vehicle is stationary
- N** = neutral
- D** = automatic mode with all gears

The selector lever is locked in **P** and can only be moved when the ignition is on and the brake pedal is applied.



Without brake pedal applied, the control indicator  illuminates.

If the selector lever is not in **P** when the ignition is switched off, the control indicator  and **P** flash.

To engage **P** or **R**, press the release button.

The engine can only be started with the lever in position **P** or **N**. When position **N** is selected, press the brake pedal or apply the parking brake before starting.

Do not accelerate while engaging a gear. Never depress the accelerator pedal and brake pedal at the same time.

When a gear is engaged, the vehicle slowly begins to creep when the brake is released.

### Engine braking

To utilise the engine braking effect, select a lower gear in good time when driving downhill, see manual mode.

### Rocking the vehicle

Rocking the vehicle is only permissible if the vehicle is stuck in sand, mud or snow. Move the selector lever between **D** and **R** in a repeat pattern. Do not race the engine and avoid sudden acceleration.

### Parking

Apply the parking brake and engage **P**.

The ignition key can only be removed when the selector lever is in position **P**.

## Manual mode



Move selector lever out of position **D** towards the left and then forwards or backwards.

**+** = Shift to a higher gear.

**-** = Shift to a lower gear.

If a higher gear is selected when vehicle speed is too low, or a lower gear when vehicle speed is too high, the shift is not executed. This can cause a message in the Driver Information Centre.

In manual mode no automatic shifting to a higher gear takes place at high engine revolutions.

## Electronic driving programmes

- Following a cold start, the operating temperature programme increases engine speed to quickly bring the catalytic converter to the required temperature.
- The automatic neutral shift function automatically shifts to idling when the vehicle is stopped with a forward gear engaged and the brake pedal is pressed.
- Special programmes automatically adapt the shifting points when driving up inclines or down hills.

## Kickdown

If the accelerator pedal is pressed down completely in automatic mode, the transmission shifts to a lower gear depending on engine speed.

## Fault

In the event of a fault,  illuminates. Additionally a code number or a vehicle message is displayed in the Driver Information Centre. Vehicle messages ⇨ 98.

The transmission no longer shifts automatically. Continued travel is possible with manual shifting.

Only the highest gear is available. Depending on the fault, second gear may also be available in manual mode. Shift only when vehicle is at a standstill.

Have the cause of the fault remedied by a workshop.

## Interruption of power supply

In the event of an interruption of power supply, the selector lever cannot be moved out of the **P** position. The ignition key cannot be removed from the ignition switch.

If the battery is discharged, start the vehicle using jump leads ⇨ 184.

If the battery is not the cause of the fault, release the selector lever.

1. Apply the parking brake.



2. Grasp the selector lever trim at the marked position and pull to unlatch at the back.
3. Fold the selector lever trim upwards. Pull to unlatch at the front.
4. Move the selector lever trim to the left. Take care that the plug and the wiring harness at the bottom are not damaged



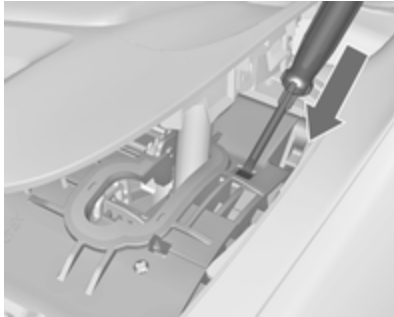

5. Insert a screwdriver into the opening as far as it will go and move the selector lever out of **P** or **N**. If **P** or **N** is engaged again, the selector lever will be locked in position again. Have the cause of the power supply interruption remedied by a workshop.
6. Mount the selector lever trim onto the centre console and refit.

## Manual transmission



To engage reverse, with the vehicle stationary press the release button on the selector lever and engage the gear.

If the gear does not engage, set the lever to neutral, release the clutch pedal and depress again; then repeat gear selection.

Do not grind the clutch unnecessarily.

When operating, depress the clutch pedal completely. Do not use the pedal as a foot rest.

### Caution

It is not advisable to drive with the hand resting on the selector lever.

## Brakes

The brake system comprises two independent brake circuits.

If a brake circuit fails, the vehicle can still be braked using the other brake circuit. However, braking effect is achieved only when the brake pedal is depressed firmly. Considerably more force is needed for this. The braking distance is extended. Seek the assistance of a workshop before continuing your journey.

When the engine is not running, the support of the brake servo unit disappears once the brake pedal has been depressed once or twice. Braking effect is not reduced, but braking requires significantly greater force. It is especially important to bear this in mind when being towed.

Control indicator  ↗ 89.

## Antilock brake system

Antilock brake system (ABS) prevents the wheels from locking.

ABS starts to regulate brake pressure as soon as a wheel shows a tendency to lock. The vehicle remains steerable, even during hard braking.

ABS control is made apparent through a pulse in the brake pedal and the noise of the regulation process.

For optimum braking, keep the brake pedal fully depressed throughout the braking process, despite the fact that the pedal is pulsating. Do not reduce the pressure on the pedal.

After starting off, the system performs a self-test which may be audible.

Control indicator  ↗ 90.

## Adaptive brake light

During full braking, all three brake lights flash for the duration of ABS control.

## Fault

### Warning

If there is a fault in the ABS, the wheels may be liable to lock due to braking that is heavier than normal. The advantages of ABS are no longer available. During hard braking, the vehicle can no longer be steered and may swerve.

Have the cause of the fault remedied by a workshop.

## Parking brake

### Electrical parking brake



#### Applying when vehicle is stationary

Pull switch (P), the electrical parking brake operates automatically with adequate force. For maximum force, e.g. parking with trailer or on inclines, pull switch (P) twice.

The electrical parking brake can always be activated, even if the ignition is off.

Do not operate electrical parking brake system too often without engine running because this will discharge the battery.

Before leaving the vehicle, check the electrical parking brake status.

Control indicator (P) ⇨ 89.

#### Releasing

Switch on ignition. Keep brake pedal depressed and then push switch (P).

#### Drive away function

Depressing clutch pedal (manual transmission) or engaging **D** (automatic transmission) and then depressing the accelerator pedal releases the electrical parking brake automatically. This is not possible when the switch is pulled at the same time.

This function also helps driving away on inclines.

Aggressive drive away may reduce life time of wear parts.

#### Dynamic braking when vehicle is moving

When the vehicle is moving and the switch (P) is kept pulled, the electrical parking brake system will decelerate the vehicle, but will not apply statically.

As soon as the switch (P) is released, dynamic braking will be stopped.

#### Fault

Failure mode of electrical parking brake is indicated by control indicator (P) and by a code number or a vehicle message which is displayed in the Driver Information Centre. Vehicle messages ⇨ 98.

Apply electrical parking brake: pull and hold the switch (P) for more than 5 seconds. If control indicator (P) illuminates, electrical parking brake is applied.

Release electrical parking brake: push and hold the switch (P) for more than 2 seconds. If control indicator (P) goes out, electrical parking brake is released.

Control indicator  flashes: electrical parking brake is not fully applied or released. When continuously flashing, release electrical parking brake and retry applying.

## Brake assist

If the brake pedal is depressed quickly and forcefully, maximum brake force is automatically applied (full braking).

Maintain steady pressure on the brake pedal for as long as full braking is required. Maximum brake force is automatically reduced when the brake pedal is released.

## Hill start assist

The system helps prevent unintended movement when driving away on inclines.

When releasing the foot brake after stopping on an incline, the brakes remain on for a further two seconds. The brakes release automatically as soon as the vehicle begins to accelerate.

The hill start assist is not active during an Autostop.

## Ride control systems

### Traction Control system

The Traction Control system (TC) is a component of the Electronic Stability Control system.

TC improves driving stability when necessary, regardless of the type of road surface or tyre grip, by preventing the drive wheels from spinning.

As soon as the drive wheels starts to spin, engine output is reduced and the wheel spinning the most is braked individually. This considerably improves the driving stability of the vehicle on slippery road surfaces.

TC is operational as soon as the control indicator  extinguishes.

When TC is active  flashes.

### ⚠ Warning

Do not let this special safety feature tempt you into taking risks when driving.

Adapt speed to the road conditions.

Control indicator  ⇨ 91.

### Deactivation



TC can be switched off when spinning of drive wheels is required: press button  briefly.

Control indicator  illuminates.

TC is reactivated by pressing the  button again.

TC is also reactivated the next time the ignition is switched on.

### Electronic Stability Control

Electronic Stability Control (ESC) improves driving stability when necessary, regardless of the type of road surface or tyre grip. It also prevents the drive wheels from spinning.

As soon as the vehicle starts to swerve (understeer/oversteer), engine output is reduced and the wheels are braked individually. This considerably improves the driving stability of the vehicle on slippery road surfaces.

ESC is operational as soon as the control indicator  extinguishes.

When ESC is active  flashes.

### ⚠ Warning

Do not let this special safety feature tempt you into taking risks when driving.

Adapt speed to the road conditions.

Control indicator  ⇨ 91.

### Deactivation



For very high-performance driving ESC can be deactivated: hold button  depressed for approx. 7 seconds.

Control indicator  illuminates.

ESC is reactivated by pressing the  button again. If the TC system was previously disabled, both TC and ESC are reactivated.

ESC is also reactivated the next time the ignition is switched on.

## Cruise control

The cruise control can store and maintain speeds of approx. 20 to 120 mph. Deviations from the stored speeds may occur when driving uphill or downhill.

For safety reasons the cruise control cannot be activated until the foot brake has been operated once. Activating in first gear is not possible.

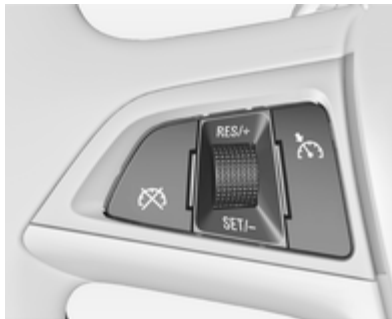



Do not use the cruise control if it is not advisable to maintain a constant speed.

With automatic transmission, only activate cruise control in automatic mode.

Control indicator   93.

### Switching on

Press rocker switch  at the upper end, control indicator  illuminates white.

### Activation

Accelerate to the desired speed and turn thumb wheel to **SET/-**, the current speed is stored and maintained. Control indicator  illuminates green. Accelerator pedal can be released.

Vehicle speed can be increased by depressing the accelerator pedal. When the accelerator pedal is released, the previously stored speed is resumed.

### Increase speed



With cruise control active, hold thumb wheel turned to **RES/+** or briefly turn to **RES/+** repeatedly: speed increases continuously or in small increments.

Alternatively accelerate to the desired speed and store by turning to **RES/+**.

### Reduce speed

With cruise control active, hold thumb wheel turned to **SET/-** or briefly turn to **SET/-** repeatedly: speed decreases continuously or in small increments.

### Deactivation

Press button , control indicator  illuminates white. Cruise control is deactivated. The stored speed is memorised.

Automatic deactivation:



- vehicle speed below approx. 20 mph,
- the brake pedal is depressed,
- the clutch pedal is depressed,
- selector lever in **N**,

- engine speed in a very low range,
- the Traction Control system or Electronic Stability Control is operating.

### Resume stored speed

Turn thumb wheel to **RES/+** at a speed above 20 mph. The stored speed will be obtained.

### Switching off

Press rocker switch  at the lower end, control indicator  extinguishes. The stored speed is deleted. Switching off the ignition also deletes the stored speed.

## Object detection systems

### Parking assist

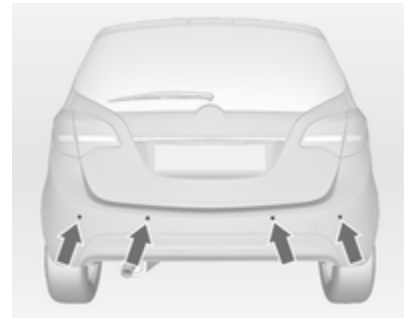

The parking assist makes parking easier by measuring the distance between the vehicle and obstacles, and giving acoustic signals. It is the driver, however, who bears full responsibility for the parking manoeuvre.

The system consists of four ultrasonic parking sensors in the rear bumper. If the vehicle is equipped with a front

parking assist the system consists of four additional ultrasonic parking sensors in the front bumper.

Control indicator **P**  ↻ 91.

### Activation



When reverse gear is engaged, the system is activated automatically.

The front parking assist can also be activated at a low speed by pressing the **P**  button.

An illuminated LED in the parking assist button indicates that the system is ready to operate.

An obstacle is indicated by a buzzing sound. The interval between the sounds becomes shorter as the vehicle gets closer to the obstacle. When the distance is less than 30 cm, the buzzing is continuous.

If the **P**  button is pressed once within an ignition cycle, the front parking assist is always reactivated when the vehicle speed goes below a certain value.

### Deactivation

Deactivate the system by pressing the **P**  button.

The LED in the button will go out and **Park Assist Off** will be displayed in the Driver Information Centre.

The system is deactivated automatically at a certain speed.

### Fault

In the event of a fault in the system, **P**  illuminates or a vehicle message is displayed in the Driver Information Centre.

Additionally, **P**  illuminates or a vehicle message is displayed in the Driver Information Centre if a malfunction of the system due to temporary conditions like snow covered sensors is detected.

Vehicle messages ↻ 98.

## Important hints for using the parking assist systems

### Warning

Under certain circumstances, various reflective surfaces on objects or clothing as well as external noise sources may cause the system to fail to detect obstacles.

Special attention has to be paid to low obstacles which can damage the lower part of the bumper. If such obstacles leave the detection area of the sensors during approach of the vehicle, a continuous warning tone will sound.



**Caution**

Performance of the sensor can be reduced when sensors are covered, e.g. by ice or snow.

Performance of the parking assist systems can be reduced due to heavy loading.

Special conditions apply if there are taller vehicles involved (e.g. off-road vehicles, mini vans, vans). Object identification in the upper part of these vehicles cannot be guaranteed.

Objects with a very small reflection cross section, like objects of narrow size or soft materials, may not be detected by the system.

Parking assist will not avoid a collision with objects which are out of the detection range of the sensors.

**Notice**

The parking assist system automatically detects factory-fitted towing equipment. It is deactivated when the connector is plugged in.

The sensor may detect a non-existent object (echo disturbance) caused by external acoustic or mechanical disturbances.

**Notice**

The parking assist is deactivated when the rear carrier system is extended.

**Fuel****Fuel for petrol engines**

Only use unleaded fuel that complies with EN 228.

Equivalent standardised fuels with an ethanol content of max. 10 % by volume may be used. In this case only use fuel that complies with E DIN 51626-1.

Use fuel with the recommended octane rating ⇨ 199. Use of fuel with too low an octane rating can reduce engine power and torque and slightly increases fuel consumption.

**Caution**

Use of fuel that does not comply to EN 228 or similar can lead to deposits or engine damage and loss of warranty.

**Caution**

Use of fuel with too low an octane rating could lead to uncontrolled combustion and engine damage.

**Fuel for diesel engines**

Only use diesel fuel that complies with EN 590.

In countries outside the European Union use Euro-Diesel fuel with a sulfur concentration below 50 ppm.

**Caution**

Use of fuel that does not comply to EN 590 or similar can lead to engine powerloss, increased wear or engine damage and loss of warranty.

Do not use marine diesel oils, heating oils, Aquazole and similar diesel-water emulsions. Diesel fuels must not be diluted with fuels for petrol engines.

**Refuelling**



**⚠ Danger**

Before refuelling, switch off engine and any external heaters with combustion chambers. Switch off any mobile phones.

Follow the operating and safety instructions of the filling station when refuelling.

**⚠ Danger**

Fuel is flammable and explosive. No smoking. No naked flames or sparks.

If you can smell fuel in your vehicle, have the cause of this remedied immediately by a workshop.

**Caution**

In case of misfuelling, do not switch on ignition.

Fuel filler flap is located at right rear side of vehicle.



The fuel filler flap can only be opened if the vehicle is unlocked. Pull flap at the recess and open.



The fuel filler cap can be retained in the bracket on the fuel filler flap.

### Caution

Wipe off any overflowing fuel immediately.

### Fuel filler cap

Only use genuine fuel filler caps. Diesel-engined vehicles have special fuel filler caps.

### Fuel consumption - CO<sub>2</sub>-Emissions

The fuel consumption is within a range of 3.9 to 8.8 l/100 km.

The CO<sub>2</sub> emission is within a range of 119 to 168 g/km.

### General information

For the values specific for your vehicle, refer to the EEC Certificate of Conformity provided with your vehicle or other national registration documents.

The determination of fuel consumption is regulated by directive R (EC) No. 715/2007 (in the newest version respectively).

The specification of CO<sub>2</sub> emission is also a constituent of the directive.

The figures given must not be taken as a guarantee for the actual fuel consumption of a particular vehicle. Furthermore, fuel consumption is dependent on personal driving style as well as road and traffic conditions.

All values are based on the EU base model with standard equipment.

The calculation of fuel consumption takes into account the vehicle's kerb weight, ascertained in accordance with the regulations. Optional equipment may result in slightly higher fuel consumption and CO<sub>2</sub> emission levels and a lower maximum speed.

## Towing

### General information

Only use towing equipment that has been approved for your vehicle.

Entrust retrofitting of towing equipment to a workshop. It may be necessary to make changes that affect the cooling system, heat shields or other equipment.

Fitting of towing equipment could cover the opening of the towing eye. If this is the case use the coupling ball bar for towing. Always keep the coupling ball bar in the vehicle.

Installation dimensions of factory-fitted towing equipment ⇨ 208.

### Driving characteristics and towing tips

Before attaching a trailer, lubricate the coupling ball. However, do not do so if a stabiliser, which acts on the coupling ball, is being used to reduce snaking movements.

For trailers with low driving stability and caravan trailers with a permitted gross vehicle weight of more than 1100 kg the use of a stabiliser is strongly recommended when driving above 50 mph.

If the trailer starts snaking, drive more slowly, do not attempt to correct the steering and brake sharply if necessary.

When driving downhill, drive in the same gear as if driving uphill and drive at a similar speed.

Adjust tyre pressure to the value specified for full load ⇨ 205.

### Trailer towing

#### Trailer loads

The permissible trailer loads are vehicle and engine-dependent maximum values which must not be exceeded. The actual trailer load is the difference between the actual gross weight of the trailer and the actual coupling socket load with the trailer coupled.

The permissible trailer loads are specified in the vehicle documents. In general, they are valid for gradients up to max. 12 %.

The permitted trailer load applies up to the specified incline and up to an altitude of 1000 metres above sea level. Since engine power decreases as altitude increases due to the air becoming thinner, therefore reducing climbing ability, the permissible gross train weight also decreases by 10 % for every 1000 metres of additional altitude. The gross train weight does not have to be reduced when driving on roads with slight inclines (less than 8 %, e.g. motorways).

The permissible gross train weight must not be exceeded. This weight is specified on the identification plate ⇨ 195.

#### Vertical coupling load

The vertical coupling load is the load exerted by the trailer on the coupling ball. It can be varied by changing the weight distribution when loading the trailer.

The maximum permissible vertical coupling load (75 kg) is specified on the towing equipment identification plate and in the vehicle documents. Always aim for the maximum load, especially in the case of heavy trailers. The vertical coupling load should never fall below 25 kg.

### Rear axle load

When the trailer is coupled and the towing vehicle fully loaded, the permissible rear axle load (see identification plate or vehicle documents) may be exceeded by 60 kg, the gross vehicle weight rating may be exceeded by 70 kg. If the permissible rear axle load is exceeded, a maximum speed of 60 mph applies.

### Towing equipment

Caution
When operating without a trailer, remove the coupling ball bar.

### Stowage of the detachable coupling ball bar

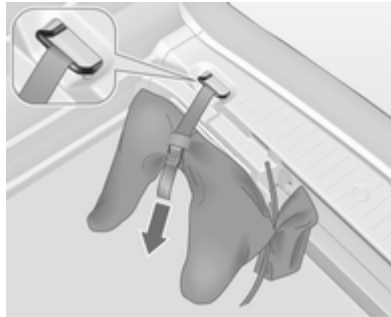

The bag with the coupling ball bar is stowed in the rear stowage compartment on the floor.

Stick the strap through the lashing eye and tighten the strap to secure the bag.

### Fitting the detachable coupling ball bar

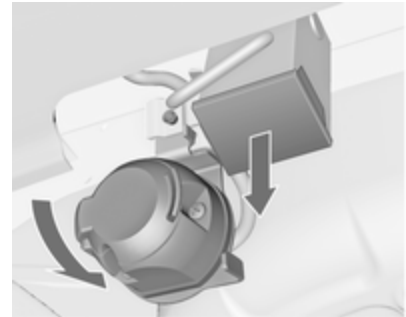

Disengage and fold down the socket. Remove the sealing plug from the opening for the coupling ball bar and stow it.

### Checking the tensioning of the coupling ball bar

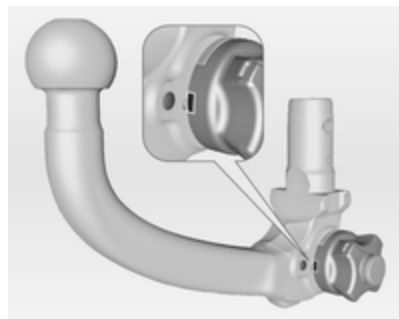

- Red marking on rotary knob must point towards green marking on coupling ball bar.
- The gap between the rotary knob and the coupling ball bar must be approx. 5 millimetres.

Otherwise, the coupling ball bar must be tensioned before being inserted:

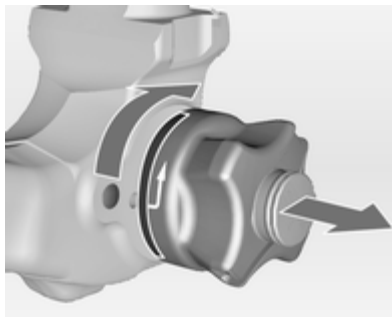

Pull out rotary knob and turn clockwise as far as it will go.

### Inserting the coupling ball bar

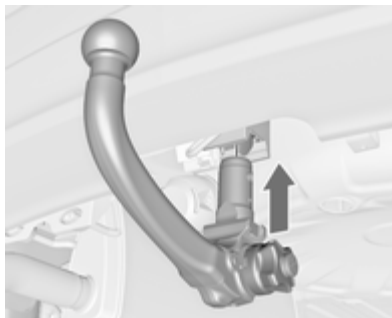

Insert the tensioned coupling ball bar in the opening and push firmly upwards until it audibly engages.

The rotary handle snaps back into its original position resting against the coupling ball bar without a gap.

#### **⚠ Warning**

Do not touch rotary handle during insertion.

Lock the coupling ball bar by turning the key clockwise. Remove the key and close the protective flap.

### Eye for break-away stopping cable

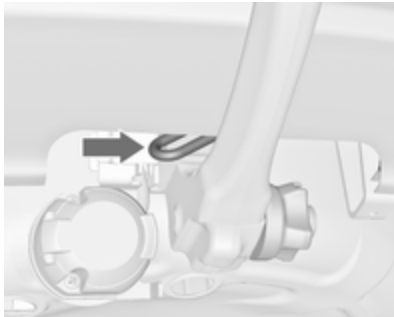

Attach breakaway stopping cable to eye.

### Check that the coupling ball bar is correctly installed

- Green marking on rotary knob must point towards green marking on coupling ball bar.
- There must be no gap between the rotary handle and the coupling ball bar.

- The coupling ball bar must be firmly engaged in the opening.
- The coupling ball bar must be locked and the key removed.

### **⚠ Warning**

Towing a trailer is permitted only when a coupling ball bar is fitted correctly. If the coupling ball bar does not engage correctly, seek the assistance of a workshop.

### Dismounting the detachable coupling ball bar

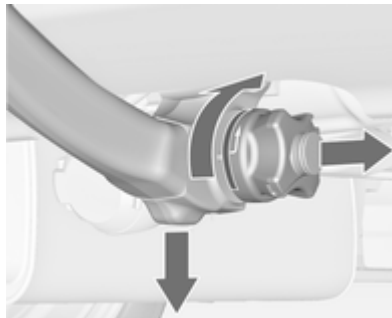

Open the protective flap and turn the key clockwise to unlock the coupling ball bar.

Pull out rotary handle and turn clockwise as far as it will go. Pull out coupling ball bar downwards.

Insert sealing plug in opening. Fold away socket.

## Vehicle care

General Information .....	150
Vehicle checks .....	151
Bulb replacement .....	157
Electrical system .....	166
Vehicle tools .....	172
Wheels and tyres .....	173
Jump starting .....	184
Towing .....	186
Appearance care .....	188

## General Information

### Accessories and vehicle modifications

We recommend the use of genuine parts and accessories and factory approved parts specific for your vehicle type. We cannot assess or guarantee reliability of other products - even if they have a regulatory or otherwise granted approval.

Do not make any modifications to the electrical system, e.g. changes of electronic control units (chip tuning).

#### Caution

When transporting the vehicle on a train or on a recovery vehicle, the mud flaps might be damaged.

## Vehicle storage

### Storage for a long period of time

If the vehicle is to be stored for several months:

- Wash and wax the vehicle.
- Have the wax in the engine compartment and underbody checked.
- Clean and preserve the rubber seals.
- Fill up fuel tank completely.
- Change the engine oil.
- Drain the washer fluid reservoir.
- Check the coolant antifreeze and corrosion protection.
- Adjust tyre pressure to the value specified for full load.
- Park the vehicle in a dry, well ventilated place. Engage first or reverse gear or set selector lever to P. Prevent the vehicle from rolling.
- Do not apply the parking brake.
- Open the bonnet, close all doors and lock the vehicle.



- Disconnect the clamp from the negative terminal of the vehicle battery. Beware that all systems are not functional, e.g. anti-theft alarm system.

### Putting back into operation

When the vehicle is to be put back into operation:

- Connect the clamp to the negative terminal of the vehicle battery. Activate the electronics of the power windows.
- Check tyre pressure.
- Fill up the washer fluid reservoir.
- Check the engine oil level.
- Check the coolant level.
- Fit the number plate if necessary.

### End-of-life vehicle recovery

Information on end-of-life vehicle recovery centres and the recycling of end-of-life vehicles is available on our website. Only entrust this work to an authorised recycling centre.

## Vehicle checks

### Performing work

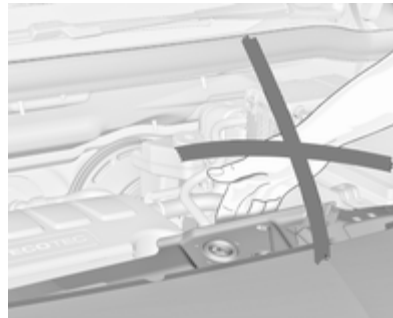

#### **⚠ Warning**

Only perform engine compartment checks when the ignition is off.

The cooling fan may start operating even if the ignition is off.

#### **⚠ Danger**

The ignition system use extremely high voltage. Do not touch.

## Bonnet

### Opening

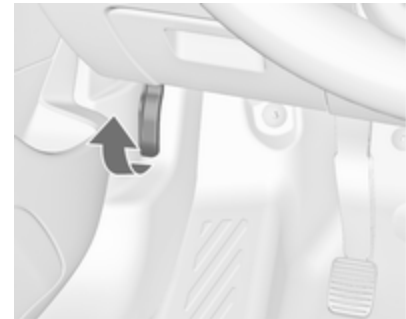

Pull the release lever and return it to its original position.

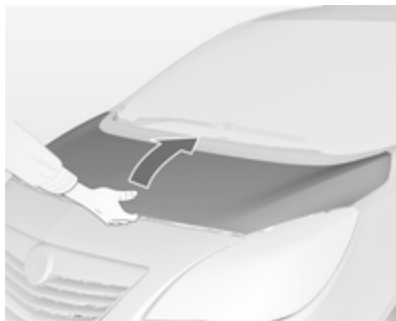

Press the safety catch and open the bonnet.

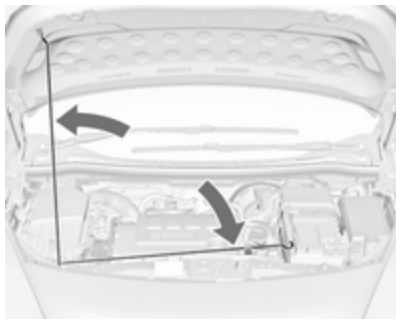

Secure the bonnet support.

If the bonnet is opened during an Autostop, the engine will be restarted automatically for safety reasons.

### Closing

Before closing the bonnet, press the support into the holder.

Lower the bonnet and allow it to drop into the catch. Check that the bonnet is engaged.

### Engine oil

Check the engine oil level manually on a regular basis to prevent damage to the engine.

Ensure that the correct specification of oil is used. Recommended fluids and lubricants ↗ 192.

Check with the vehicle on a level surface. The engine must be at operating temperature and switched off for at least 5 minutes.

Pull out the dipstick, wipe it clean, insert it to the stop on the handle, pull out and read the engine oil level.

Insert dipstick to the stop on the handle and make half a turn.

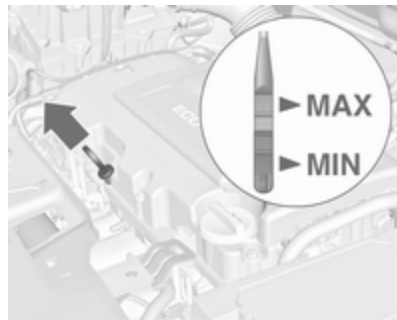

Different dipsticks are used depending on engine variant.

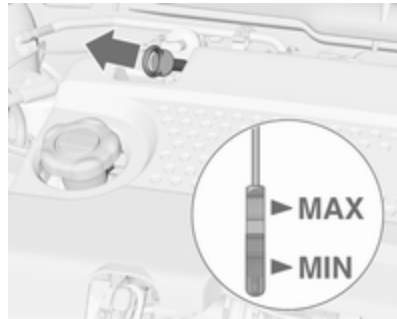

When the engine oil level has dropped to the **MIN** mark, top up engine oil.

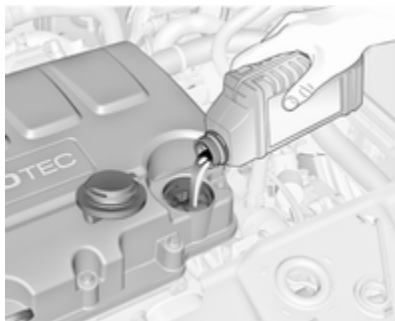

We recommend the use of the same grade of engine oil that was used at last change.

The engine oil level must not exceed the **MAX** mark on the dipstick.

### Caution

Overfilled engine oil must be drained or suctioned out.

Capacities ⇨ 204.

Fit the cap on straight and tighten it.

## Engine coolant

The coolant provides freeze protection down to approx. -28 °C.

### Caution

Only use approved antifreeze.

### Coolant level

### Caution

Too low a coolant level can cause engine damage.

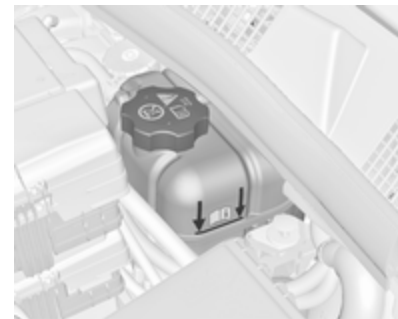

If the cooling system is cold, the coolant level should be above the filling line mark. Top up if the level is low.

### Warning

Allow the engine to cool before opening the cap. Carefully open the cap, relieving the pressure slowly.

To top up use a 1:1 mixture of approved coolant concentrate mixed with clean tap water. If no coolant concentrate is available, use clean tap water. Install the cap tightly. Have

the coolant concentration checked and have the cause of the coolant loss remedied by a workshop.

## Washer fluid



Fill with clean water mixed with a suitable quantity of washer fluid which contains antifreeze. For the correct mixing ratio refer to the washer fluid container.

### Caution

Only washer fluid with a sufficient antifreeze concentration provides protection at low temperatures or a sudden drop in temperature.

## Brakes

In the event of minimum thickness of the brake lining, a squealing noise sounds during braking.

Continued driving is possible but have the brake lining replaced as soon as possible.

Once new brake linings are installed, do not brake unnecessarily hard for the first few journeys.

## Brake fluid

### ⚠ Warning

Brake fluid is poisonous and corrosive. Avoid contact with eyes, skin, fabrics and painted surfaces.

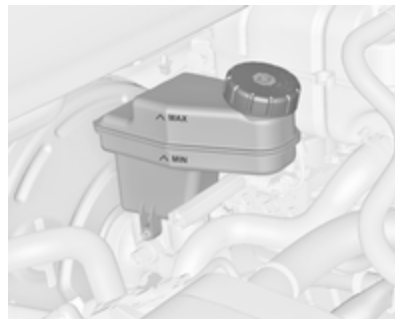

The brake fluid level must be between the **MIN** and the **MAX** marks.

When topping up, ensure maximum cleanliness as contamination of the brake fluid can lead to brake system malfunctions. Have the cause of the loss of brake fluid remedied by a workshop.

Only use high-performance brake fluid approved for the vehicle.

Brake and clutch fluid ⇨ 192.

## Battery

The vehicle battery is maintenance-free provided that the driving profile allows sufficient charging of the battery. Short-distance-driving and frequent engine starts can discharge the battery. Avoid the use of unnecessary electrical consumers.



Batteries do not belong in household waste. They must be disposed of at an appropriate recycling collection point.

Laying up the vehicle for more than 4 weeks can lead to battery discharge. Disconnect the clamp from the negative terminal of the vehicle battery.

Ensure the ignition is switched off before connecting or disconnecting the vehicle battery.

The anti-theft alarm siren must be deactivated as follows: Switch the ignition on then off, disconnect the vehicle's battery within 15 seconds. Battery discharge protection ⇨ 116.

## Replacing the battery

### Notice

Any deviation from the instructions given in this paragraph may lead to a temporary deactivation of the stop-start system.

In vehicles with stop-start system, ensure to have the AGM (Absorptive Glass Mat) battery replaced with an AGM battery again.



An AGM battery can be identified by the label on the battery. We recommend the use of an original Vauxhall battery.

### Notice

Using an AGM battery different from the original Vauxhall battery might result in a lower performance of the stop-start system.

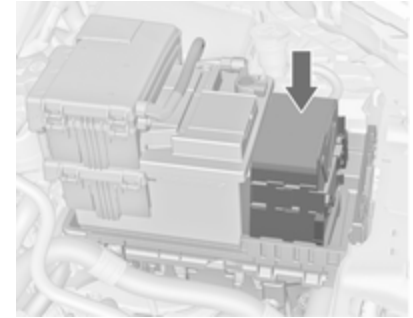

### Warning

When fitting a battery with a length deviating from the original one, it is essential to ensure a proper fitting of the buffer element.

We recommend that you have the battery replaced by a workshop.

Stop-start system ⇨ 128.

## Charging the battery

### Warning

On vehicles with stop-start system, ensure that the charging potential does not exceed 14.6 volts when using a battery charger. Otherwise the battery might be damaged.

Jump starting ⇨ 184.

## Warning label



Meaning of symbols:

- No sparks, naked flames or smoking.
- Always shield eyes. Explosive gases can cause blindness or injury.
- Keep the battery out of reach of children.
- The battery contains sulfuric acid which could cause blindness or serious burn injuries.

- See the Owner's Manual for further information.
- Explosive gas may be present in the vicinity of the battery.

## Diesel fuel system bleeding

If the tank has been run dry, the diesel fuel system must be bled. Switch on the ignition three times for 15 seconds at a time. Then start the engine for a maximum of 40 seconds. Repeat this process after no less than 5 seconds. If the engine fails to start, seek the assistance of a workshop.

## Wiper blade replacement

### Wiper blades on the windscreen

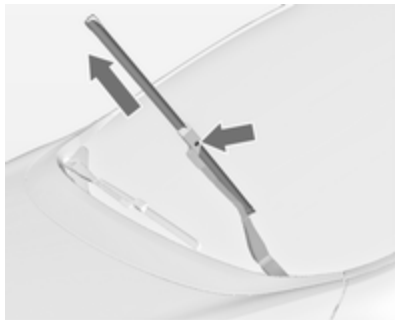

Lift the wiper arm, press button to disengage the wiper blade and remove.

Attach the wiper blade slightly angled to the wiper arm and push until it engages.

Lower wiper arm carefully.

### Wiper blade on the rear window



Lift wiper arm. Disengage wiper blade as shown in illustration and remove.

Attach the wiper blade slightly angled to the wiper arm and push until it engages.

Lower wiper arm carefully.

## Bulb replacement

Switch off the ignition and switch off the relevant switch or close the doors.

Only hold a new bulb at the base! Do not touch the bulb glass with bare hands.

Use only the same bulb type for replacement.

Replace headlight bulbs from within the engine compartment.

## Halogen headlights

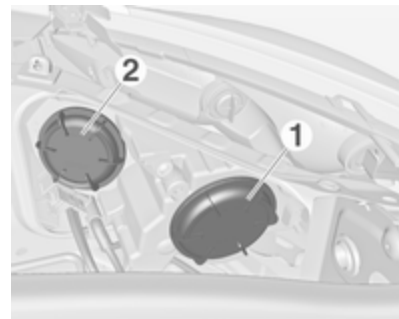

Headlights have separate systems for low beam **1** (outer bulbs) and high beam **2** (inner bulbs).

### Low beam

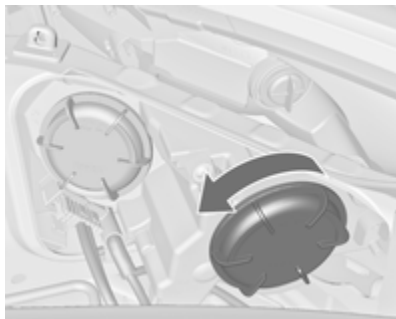

1. Rotate the cap **1** anticlockwise and remove it.

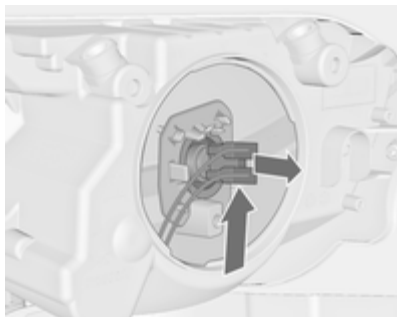

2. Push the bulb holder upwards and withdraw the bulb holder from the reflector.

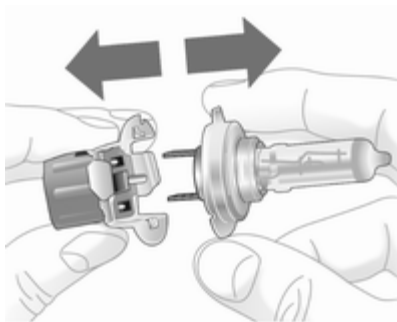

3. Detach the bulb from the bulb holder and replace the bulb.
4. Insert the bulb holder into the reflector.
5. Fit the cap and rotate clockwise.

### High beam



1. Rotate the cap **2** anticlockwise and remove it.
2. Detach the plug from the bulb.





3. Disengage the spring clip and then swivel it backwards.

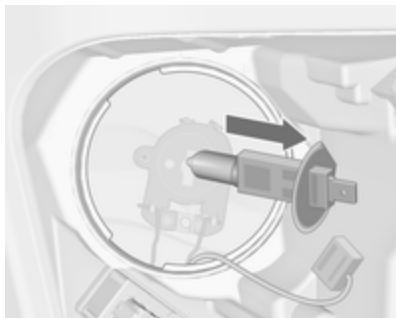

4. Remove and replace the bulb.

5. Swivel the spring clip forwards and engage.
6. Attach the plug to the bulb.
7. Fit the cap and rotate clockwise.

### Sidelight/Daytime running light



1. Rotate the bulb holder anticlockwise and remove it.

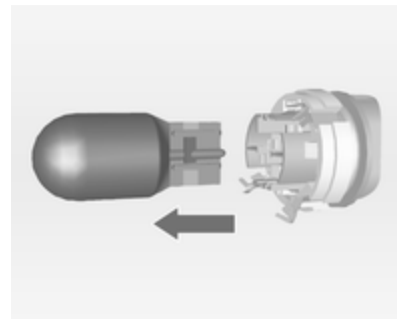

2. Detach bulb from the bulb holder and replace it.
3. Insert the bulb holder into the reflector and rotate clockwise.

### Front turn signal

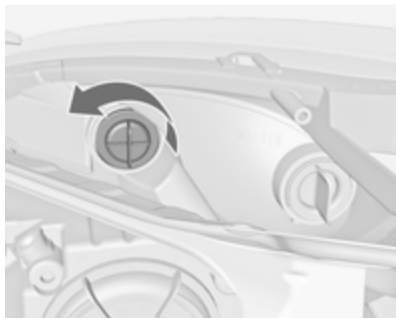

1. Rotate the bulb holder anticlockwise and remove it.

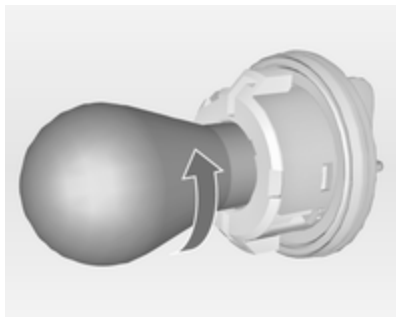

2. Rotate bulb anticlockwise and remove from bulb holder.
3. Replace bulb.
4. Insert the bulb holder into the reflector and rotate clockwise.

### Adaptive forward lighting

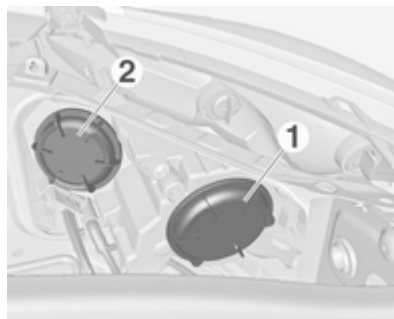

Headlights have separate systems for low beam and high beam **1** (outer bulbs) and additional high beam **2** (inner bulbs). The cornering light is also located behind the cover for the additional high beam.

### Low beam/High beam



1. Rotate the cap **1** anticlockwise and remove it.

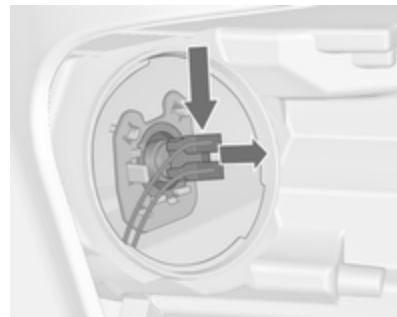

2. Push the bulb holder downwards and withdraw the bulb holder from the reflector.

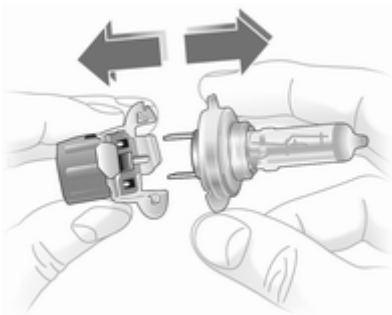

3. Detach the bulb from the bulb holder and replace the bulb.
4. Insert the bulb holder into the reflector.
5. Fit the cap and rotate clockwise.

### Additional high beam



1. Rotate protective cover **2** anticlockwise and remove.

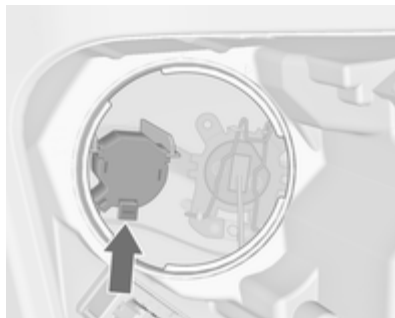

2. Press catch and withdraw the bulb holder from the reflector.

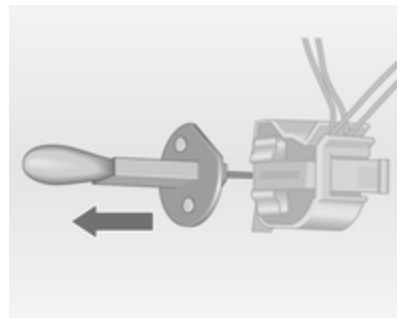

3. Remove and replace the bulb.
4. Press catch and insert the bulb holder into the reflector.
5. Fit the cap and rotate clockwise.

### Cornering light

1. Rotate protective cover **2** anticlockwise and remove.
2. Detach the plug from the bulb.

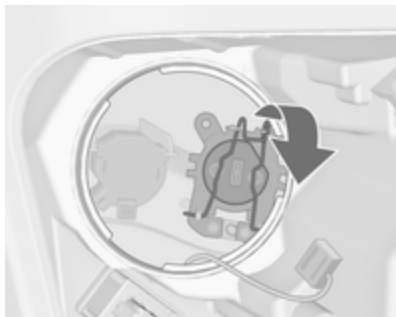

3. Disengage the spring clip and then swivel it backwards.

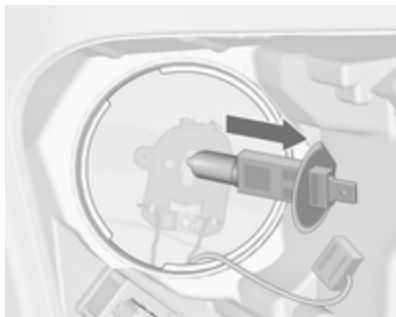

4. Remove and replace the bulb.

5. Swivel the spring clip forwards and engage.
6. Attach the plug to the bulb.
7. Fit the cap and rotate clockwise.

## Fog lights

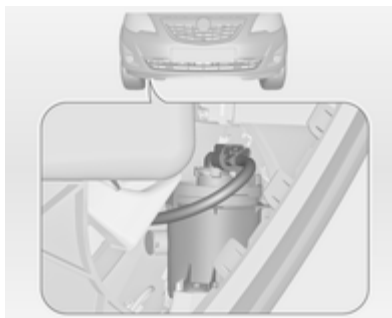

The bulbs are accessible from the underside of the vehicle.



1. Turn the bulb holder anticlockwise and remove it from the reflector.

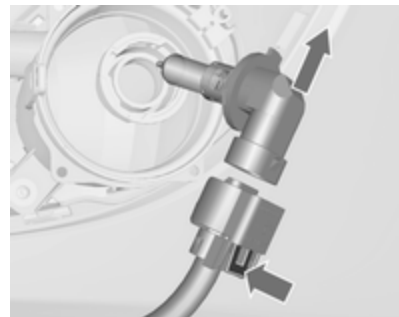

2. Disengage the bulb holder from the plug connector by pressing the retaining lug.
3. Remove and replace the bulb holder with bulb.
4. Attach the plug connector.
5. Insert the bulb holder into the reflector.
6. Turn the bulb holder clockwise and engage.

## Tail lights



1. Release the cover and remove it.



2. Unscrew the two plastic securing nuts from the inside by hand.

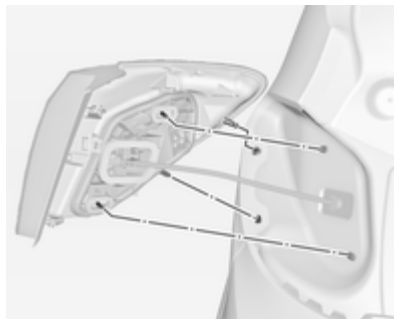

3. Carefully withdraw the light assembly from retaining pins and remove. Make sure that the cable duct remains in position.
4. Detach the wiring plug from the bulb carrier.

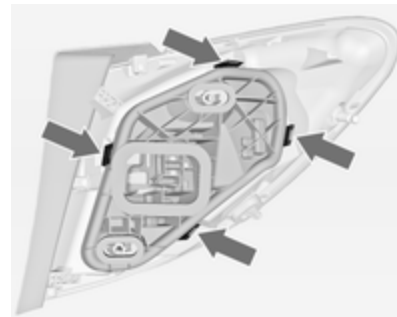

5. Unlatch the four retaining lugs and remove the bulb carrier.

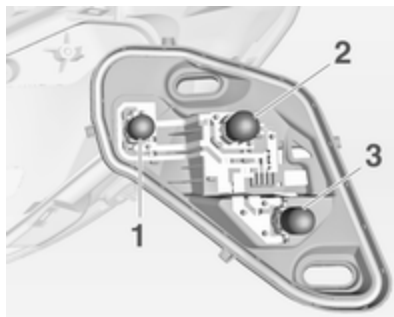

6. Remove and replace the bulb.  
Tail light and brake light (1)  
Tail light (2)  
Turn signal light (3)
7. Insert the bulb carrier into the tail light assembly. Connect the wiring plug. Fit light assembly onto retaining pins and tighten the securing nuts. Close the cover and engage.
8. Switch on the ignition, operate and check all lights.

### Tail lights in the tailgate frame



1. Open the tailgate and remove the cover with a screwdriver.

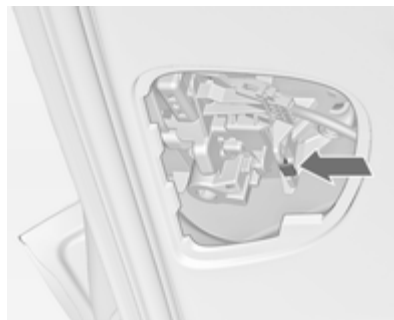

2. Press the retaining lug and remove the bulb carrier downwards.

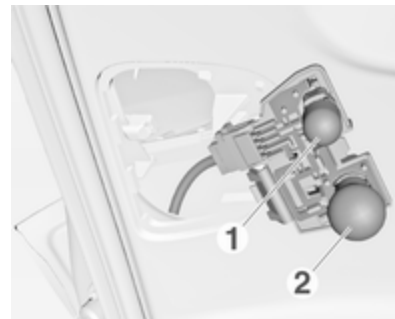

3. To replace the reverse light bulb (1), remove and replace the bulb  
To replace the tail light bulb (2), push the bulb slightly into the socket, rotate anticlockwise, remove and replace the bulb.
4. Insert the bulb carrier into the retainer.
5. Attach the cover.
6. Switch on the ignition, operate and check all lights.

For replacing the tail light bulb and rear fog light bulb on the right side of the tailgate frame, proceed in the same way.

## Side turn signal lights

Have bulbs replaced by a workshop.

## Number plate light

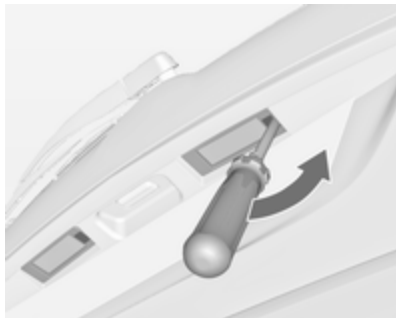

1. Insert screwdriver in recess of the cover, press to the side and release spring.  
Remove cover.

2. Remove the bulb holder downwards, taking care not to pull on the cable.

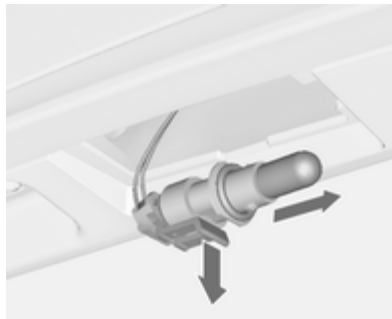

3. Disengage the retaining lug and remove the bulb holder from the wiring plug.
4. Remove and replace the bulb holder with bulb.
5. Connect the wiring plug to the bulb holder.
6. Push the bulb holder into the housing and close the cover.

## Interior lights

### Courtesy light, reading lights

Have bulbs replaced by a workshop.

### Load compartment light

Have bulbs replaced by a workshop.

### Puddle lights

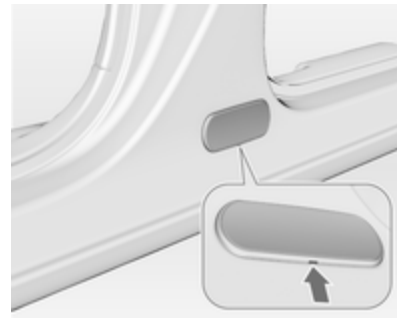

1. Disengage the housing at the bottom and remove it.

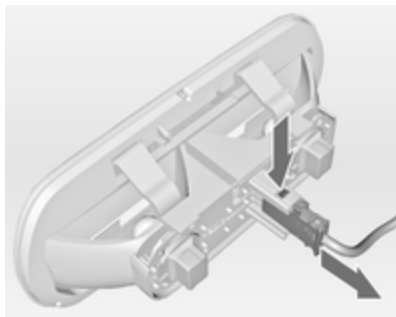

2. Press the retaining lug and withdraw the connector.

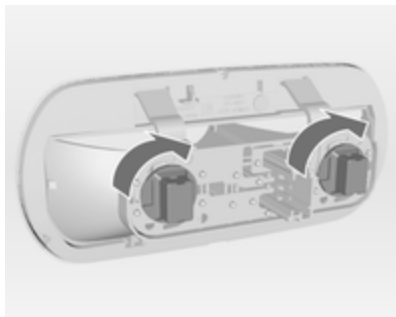

3. Rotate the bulb holder clockwise and remove.

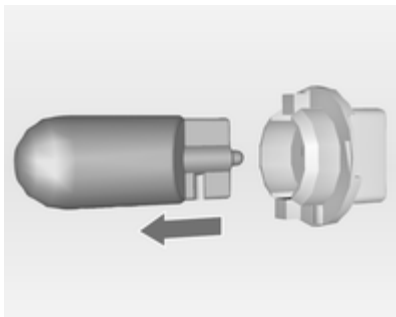

4. Pull the bulb out of the bulb holder and replace it.  
 5. Insert the bulb holder into the housing and turn it anticlockwise.  
 6. Plug in the connector.  
 7. Attach the housing.

## Instrument panel illumination

Have bulbs replaced by a workshop.

## Electrical system

### Fuses

Data on the replacement fuse must match the data on the defective fuse.

There are three fuse boxes in the vehicle:

- in the front left of the engine compartment,
- In left-hand drive vehicles, in the interior behind the storage compartment, or, in right-hand drive vehicles, behind the glovebox,
- behind a cover on the left side of the load compartment.

Before replacing a fuse, turn off the respective switch and the ignition.

A blown fuse can be recognized by its melted wire. Do not replace the fuse until the cause of the fault has been remedied.

Some functions are protected by several fuses.

Fuses may also be inserted without existence of a function.



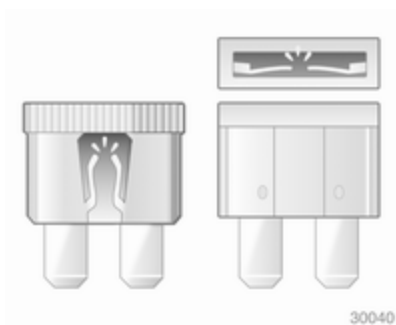

30040



30041

### Fuse extractor

A fuse extractor may be located in the fuse box in the engine compartment.

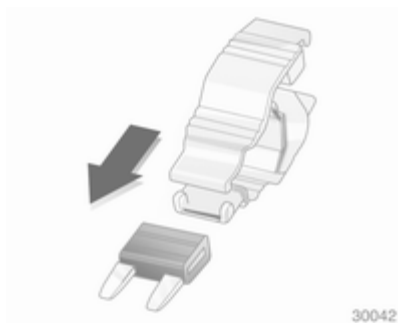

30042

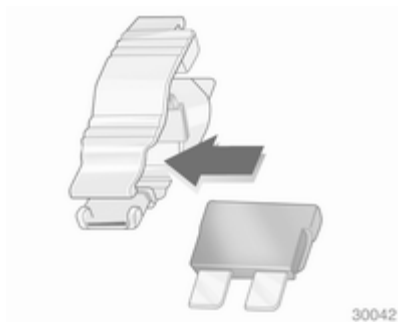

30042

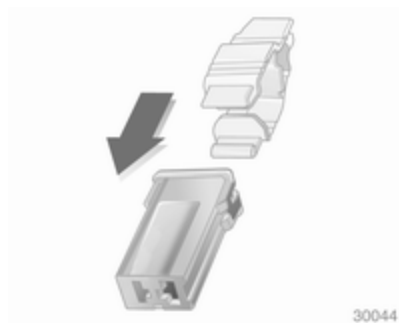

30044

Place the fuse extractor on the various types of fuse from the top or side, and withdraw fuse.

## Engine compartment fuse box

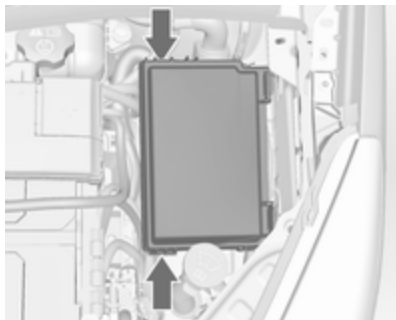

The fuse box is in the front left of the engine compartment.

Disengage the cover, lift it upwards and remove.

After having changed defective fuses close the fuse box cover and press until it engages.

If the fuse box cover is not closed correctly, malfunctions may occur.

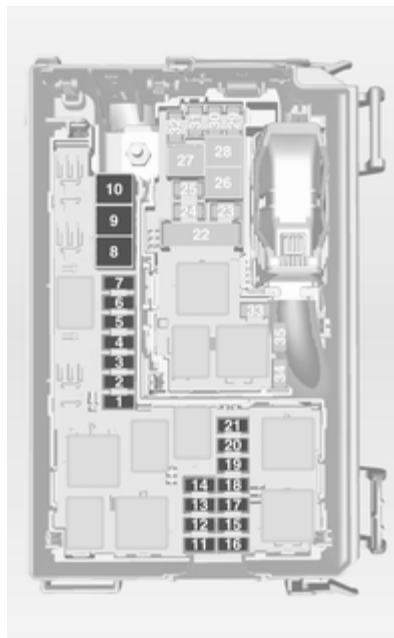

### No. Circuit

- | No. | Circuit  |
|-----|--|
| 1   | Starter  |
| 2   | –  |
| 3   | Fuel filter, cooling                             |
| 4   | Horn   |
| 5   | Terminal 30                                      |
| 6   | Engine control module, transmission control unit |
| 7   | Fog light  |
| 8   | Engine cooling                                   |
| 9   | Engine cooling                                   |
| 10  | Vacuum pump                                      |
| 11  | Ignition, preheating                             |
| 12  | Headlamp levelling                               |
| 13  | Air conditioning system, terminal 15             |
| 14  | Transmission control unit                        |
| 15  | High beam right                                  |

**No. Circuit**

- 16 High beam left
- 17 Engine control module
- 18 Engine control module, terminal 15
- 19 Airbag
- 20 Engine control module
- 21 Engine control module, terminal 87

**No. Circuit**

- 22 Electrical parking brake
- 23 Tyre repair kit
- 24 Fuel pump
- 25 ABS
- 26 Heated rear window
- 27 ABS
- 28 Interior fan
- 29 Cigarette lighter
- 30 Air conditioning system
- 31 Front power window, left
- 32 Front power window, right
- 33 Mirror heating
- 34 ABS
- 35 Airbag

## Instrument panel fuse box

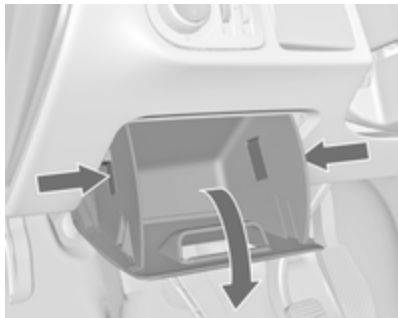

In left-hand drive vehicles, the fuse box is behind the storage compartment in the instrument panel. Open compartment, compress the locking tabs, fold compartment down and remove.

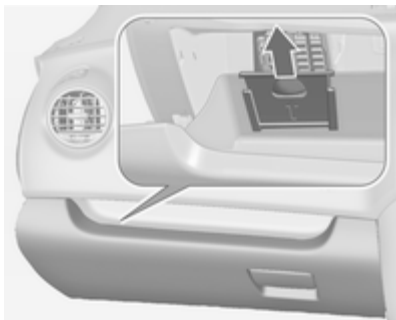

In right-hand drive vehicles, the fuse box is located behind a cover in the glovebox. Open the glovebox, pull cover upwards and remove.



### No. Circuit

- | No. | Circuit                                       |
|-----|---|
| 1   | Radio   |
| 2   | Display, instrument, telephone                |
| 3   | Radio   |
| 4   | Ignition switch, immobiliser                  |
| 5   | Windscreen washer, rear screen washer         |
| 6   | Central locking system, tailgate              |
| 7   | Central locking system                        |
| 8   | Display, instrument, telephone                |
| 9   | Heated steering wheel                         |
| 10  | Rear left door unlocking                      |
| 11  | Rear right door unlocking                     |
| 12  | Courtesy light                                |
| 13  | Rain sensor, interior mirror, outside mirrors |
| 14  | –   |

## Load compartment fuse box



The fuse box is on the left side of the load compartment behind a cover. Remove the cover.

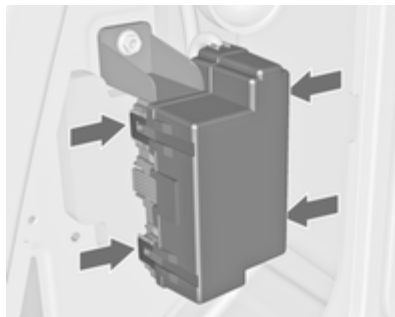

Disengage the four retaining lugs and remove the cover.



**No. Circuit**

- 1 Adaptive forward lighting
- 2 –
- 3 –
- 4 –
- 5 –
- 6 Rear power window, right
- 7 Adaptive forward lighting
- 8 Trailer module, Trailer socket
- 9 Seat, lumbar support, left
- 10 Rear power window, left
- 11 Park assist
- 12 Electrical sunblind
- 13 –
- 14 Heated front seats
- 15 Trailer module
- 16 Seat, lumbar support, right
- 17 –

**Vehicle tools**

**Tools**

**Vehicles with spare wheel**



The jack and the vehicle tools are in the spare wheel well in the load compartment.

**Vehicles with tyre repair kit**



To open the compartment, disengage the cover and open it.



The vehicle tools are in the right-hand compartment in the load compartment, together with the tyre repair kit.

## Wheels and tyres

### Tyre condition, wheel condition

Drive over edges slowly and at right angles if possible. Driving over sharp edges can cause tyre and wheel damage. Do not trap tyres on the kerb when parking.

Regularly check the wheels for damage. Seek the assistance of a workshop in the event of damage or unusual wear.

### Winter tyres

Winter tyres improve driving safety at temperatures below 7 °C and should therefore be fitted on all wheels.

In accordance with country-specific regulations, affix the speed sticker in the driver's field of view.

## Tyre designations

E.g. 195/65 R 15 91 H

- 195** = Tyre width, mm
- 65** = Cross-section ratio (tyre height to tyre width), %
- R** = Belt type: Radial
- RF** = Type: RunFlat
- 15** = Wheel diameter, inches
- 91** = Load index e.g. 91 is equivalent to 615 kg
- H** = Speed code letter

Speed code letter:

- Q** = up to 100 mph
- S** = up to 112 mph
- T** = up to 118 mph
- H** = up to 130 mph
- V** = up to 150 mph
- W** = up to 168 mph

## Tyre pressure

Check the pressure of cold tyres at least every 14 days and before any long journey. Do not forget the spare wheel. This also applies to vehicles with tyre pressure monitoring system.

Unscrew the valve cap.



Tyre pressure ⇨ 205 and on the label at the front passenger door.

The tyre pressure data refers to cold tyres. It applies to summer and winter tyres.

Always inflate the spare tyre to the pressure specified for full load.

The ECO tyre pressure serves to achieve the smallest amount of fuel consumption possible.

Incorrect tyre pressures will impair safety, vehicle handling, comfort and fuel economy and will increase tyre wear.

### ⚠ Warning

If the pressure is too low, this can result in considerable tyre warm-up and internal damage, leading to tread separation and even to tyre blow-out at high speeds.

If the tyre pressure must be reduced or increased on a vehicle with tyre pressure monitoring system, switch off ignition.

### Tyre deflation detection system

The tyre deflation detection system continually checks the rotation speed of all four tyres.

If a tyre loses pressure the control indicator (⚠) illuminates yellow and a warning message is displayed in the Driver Information Centre with Uplevel-Display. Stop immediately and check tyre pressure.

Control indicator (⚠) ⇨ 92.

### System initialisation



After tyre pressure correction or wheel change, the system must be initiated: Switch on the ignition, press and hold the **DDS** button for approx. 4 seconds.

If the system is ready again, a message is displayed in the Driver Information Centre with Uplevel-Display.

### Tread depth

Check tread depth at regular intervals.



Tyres should be replaced for safety reasons at a tread depth of 2-3 mm (4 mm for winter tyres).



The legally permissible minimum tread depth (1.6 mm) has been reached when the tread has worn down as far as one of the tread wear indicators (TWI). Their position is indicated by markings on the sidewall.

If there is more wear at the front than the rear, swap round front wheels and rear wheels periodically. Ensure that the direction of rotation of the wheels is the same as before.

Tyres age, even if they are not used. We recommend tyre replacement every 6 years.

## Changing tyre and wheel size

If tyres of a different size than those fitted at the factory are used, it may be necessary to reprogramme the speedometer as well as the nominal tyre pressure and make other vehicle modifications.

After converting to a different tyre size, have the label with tyre pressures replaced.

### **⚠ Warning**

Use of unsuitable tyres or wheels may lead to accidents and will invalidate the vehicle type approval.

## Wheel covers

Wheel covers and tyres that are factory approved for the respective vehicle and comply with all of the relevant wheel and tyre combination requirements must be used.

If the wheel covers and tyres used are not factory approved, the tyres must not have a rim protection ridge.

Wheel covers must not impair brake cooling.

### **⚠ Warning**

Use of unsuitable tyres or wheel covers could lead to sudden pressure loss and thereby accidents.

## Tyre chains



Tyre chains are only permitted on the front wheels.

Always use fine mesh chains that add no more than 10 mm to the tyre tread and the inboard sides (including chain lock).

### ⚠ Warning

Damage may lead to tyre blowout.

Tyre chains are only permitted on tyres of size 195/65 R 15, 205/55 R 16 and 225/45 R 17.

Tyre chains are not permitted on tyres of size 225/40 R 18.

The use of tyre chains is not permitted on the temporary spare wheel.

## Tyre repair kit

Minor damage to the tyre tread can be repaired with the tyre repair kit.

Do not remove foreign bodies from the tyres.

Tyre damage exceeding 4 mm or that is at the tyre's sidewall near the rim cannot be repaired with the tyre repair kit.

### ⚠ Warning

Do not drive faster than 50 mph.

Do not use for a lengthy period.

Steering and handling may be affected.

If you have a flat tyre:

Apply the parking brake and engage first gear, reverse gear or **P**.

The tyre repair kit is in the stowage compartment in the load compartment.



To open the compartment, disengage the cover and open it.



1. Take the sealant bottle and bracket with air hose from the insert.



2. Detach air hose from bracket and screw onto sealant bottle connection.

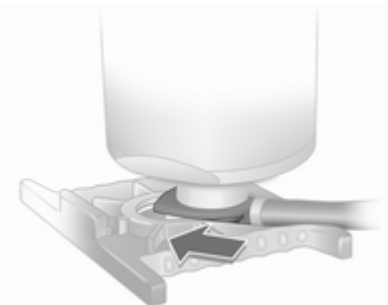

3. Position the sealant bottle on the bracket. Make sure that the bottle does not fall.



4. Unscrew valve cap from defective tyre.
5. Screw tyre inflation hose to valve.
6. Screw air hose onto compressor connection.
7. Switch on ignition.  
To avoid discharging the battery, we recommend running the engine.



8. Press on/off switch on the compressor. The tyre is filled with sealant.
9. The compressor pressure gauge briefly indicates up to 6 bar whilst the sealant bottle is emptying (approx. 30 seconds). Then the pressure starts to drop.
10. All of the sealant is pumped into the tyre. Then the tyre is inflated.
11. The prescribed tyre pressure should be obtained within 10 minutes. Tyre pressure ⇨ 205. When the correct pressure is obtained, switch off the

compressor by pressing the on/off switch again.

If the prescribed tyre pressure is not obtained within 10 minutes, remove the tyre repair kit. Move the vehicle one tyre rotation. Reattach the tyre repair kit and continue the filling procedure for 10 minutes. If the prescribed tyre pressure is still not obtained, the tyre is too badly damaged. Seek the assistance of a workshop.

Release excess tyre pressure using the — button.

Do not run the compressor longer than 10 minutes.

12. Push catch on bracket to remove sealant bottle from bracket. Screw the tyre inflation hose to the free connection of the sealant bottle. This prevents sealant from escaping. Stow tyre repair kit in load compartment.
13. Remove any excess sealant using a cloth.

14. Take the label indicating maximum permitted speed from the sealant bottle and affix in the driver's field of view.

15. Continue driving immediately so that sealant is evenly distributed in the tyre. After driving approx. 6 miles (but no more than 10 minutes), stop and check tyre pressure. Screw compressor air hose directly onto tyre valve and compressor when doing this.

If tyre pressure is more than 1.3 bar, set it to the correct value. Repeat the procedure until there is no more loss of pressure.

If the tyre pressure has fallen below 1.3 bar, the vehicle must not be used. Seek the assistance of a workshop.

16. Stow away tyre repair kit in load compartment.

**Notice**

The driving characteristics of the repaired tyre is severely affected, therefore have this tyre replaced.

If unusual noise is heard or the compressor becomes hot, turn compressor off for at least 30 minutes.

The built-in safety valve opens at a pressure of 7 bar.

Note the expiry date of the kit. After this date its sealing capability is no longer guaranteed. Pay attention to storage information on sealant bottle.

Replace the used sealant bottle. Dispose of the bottle as prescribed by applicable laws.

The compressor and sealant can be used from approx. -30 °C.

The adapters supplied can be used to pump up other items e.g. footballs, air mattresses, inflatable dinghies etc. They are located on the underside of the compressor. To remove, screw on compressor air hose and withdraw adapter.

**Wheel changing**

Some vehicles are equipped with a tyre repair kit instead of a spare wheel ⇨ 176.

Make the following preparations and observe the following information:

- Park the vehicle on a level, firm and non-skid surface. The front wheels must be in the straight-ahead position.
- Apply the parking brake and engage first gear, reverse gear or P.
- Remove the spare wheel ⇨ 182.
- Never change more than one wheel at once.
- Use the jack only to change wheels in case of puncture, not for seasonal winter or summer tyre change.
- If the ground on which the vehicle is standing is soft, a solid board (max. 1 cm thick) should be placed under the jack.
- No people or animals may be in the vehicle when it is jacked-up.

- Never crawl under a jacked-up vehicle.
- Do not start the vehicle when it is raised on the jack.
- Before screwing in the wheel bolts, clean them and lightly coat the taper of each wheel bolt with commercially available grease.



1. Pull off the wheel cover with the hook. Vehicle tools ⇨ 172.

For wheel covers with visible wheel bolts: The cover can remain on the wheel. Do not remove the retaining rings on the wheel bolts.

Alloy wheels: Disengage wheel bolt caps with a screwdriver and remove. To protect the wheel, place a soft cloth between the screwdriver and the alloy wheel.

2. Variant 1:

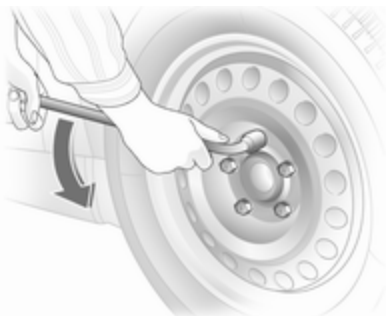

Install the wheel wrench ensuring that it locates securely and loosen each wheel bolt by half a turn.

Variant 2:

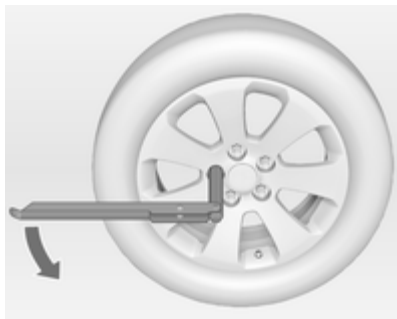

Fold out the wheel wrench and install ensuring that it locates securely and loosen each wheel nut by half a turn.

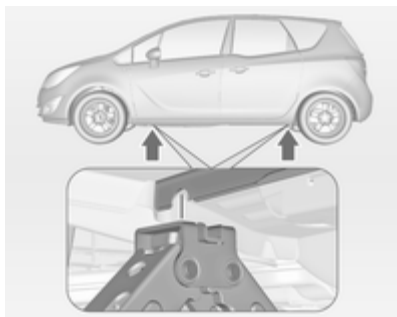

3. Ensure the jack is positioned correctly with the vehicle jacking points.

Lifting the vehicle onto a lifting platform:

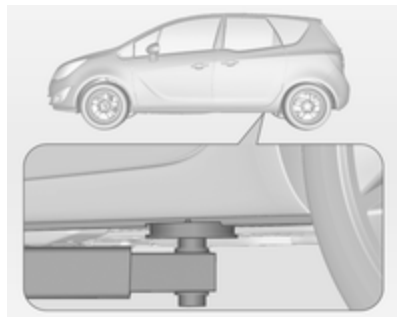

Position the rear arm of the lifting platform at the underbody.

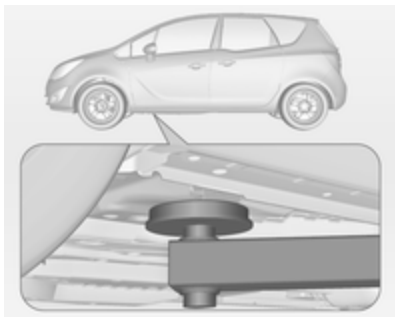

Position the front arm of the lifting platform at the underbody.

#### 4. Variant 1:

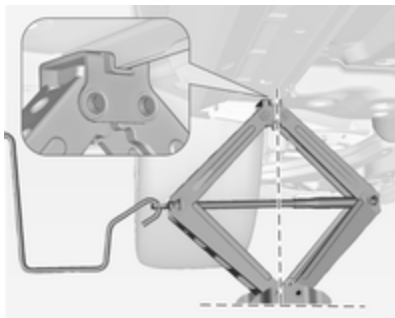

Set the jack to the necessary height. Position it directly below

the jacking point in a manner that prevents it from slipping.



Attach jack handle and with the jack correctly aligned rotate handle until wheel is clear of the ground.

#### Variant 2:

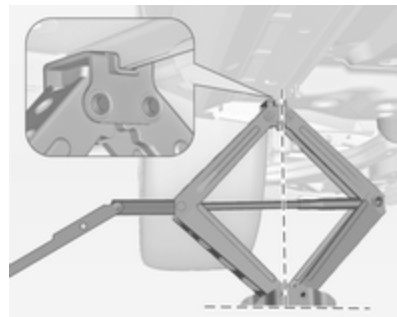

Set the jack to the necessary height. Position it directly below the jacking point in a manner that prevents it from slipping.



Attach wheel wrench and with the jack correctly aligned rotate wheel wrench until wheel is clear of the ground.

5. Unscrew the wheel bolts.
6. Change the wheel.
7. Screw on the wheel bolts.
8. Lower vehicle.
9. Install the wheel wrench ensuring that it locates securely and tighten each bolt in a crosswise sequence. Tightening torque is 110 Nm.
10. Align the valve hole in the wheel cover with the tyre valve before installing.

Install wheel bolt caps.

11. Stow the replaced wheel ↻ 182 and the vehicle tools ↻ 172.
12. Check the tyre pressure of the installed tyre and also the wheel bolt torque as soon as possible.

Have the defective tyre renewed or repaired.

## Spare wheel

Some vehicles are equipped with a tyre repair kit instead of a spare wheel.

The spare wheel can be classified as a temporary spare wheel depending on the size compared to the other mounted wheels and country regulations.

The spare wheel has a steel rim.

The use of a spare wheel that is smaller than the other wheels or in combination with winter tyres could affect driveability. Have the defective tyre replaced as soon as possible.



The spare wheel is located in the load compartment beneath the floor covering. It is secured with a wing nut. The spare wheel well is not designed for all permissible tyre sizes. If a wheel wider than the spare wheel has to be stowed in the load compartment, it needs to be secured with a strap or, depending on the version, with an extension bar.

### Storing a replaced wheel in the load compartment using a strap

Use the strap placed in the tool box. Vehicle tools ↻ 172.

- Position the wheel on the load compartment floor close to one sidewall of the load compartment.





- Place the loop end of the strap through the front lashing eye of the according side.
- Place the hook end of the strap through the loop and pull it until the strap is fastened securely to the lashing eye.

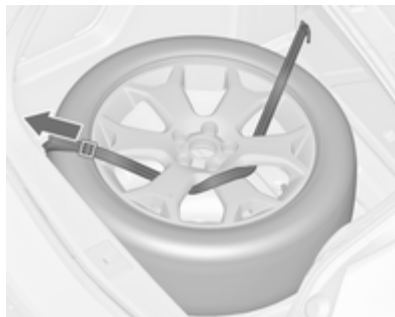

- Insert the strap through the spokes of the wheel as shown in the illustration.
- Mount the hook to the rear lashing eye.
- Tighten the strap and secure it using the buckle.

### Storing a replaced wheel in the spare wheel well using an extension bar

Use the extension bar placed in the tool box. Vehicle tools ↗ 172.

- Turn the wing nut anticlockwise and remove temporary spare wheel.



- Take the extension bar from the tool box and screw it on the bolt.
- Store the damaged wheel and secure it by turning the wing nut clockwise.

The floor cover can be placed on the projecting wheel.

Remove the extension bar before fitting the spare wheel in the well after renewing or repairing the defective wheel.

**⚠ Warning**

Storing a jack, a wheel or other equipment in the load compartment could cause injury if they are not fixed properly. During a sudden stop or a collision, loose equipment could strike someone.

Store jack and tools always in the respective storage compartments and secure them by fixing.

Place the damaged wheel always in the load compartment secured by the strap or in the spare wheel well secured by the wing nut.

**Temporary spare wheel**

The use of the temporary spare wheel could affect driveability. Have the defective tyre renewed or repaired as soon as possible.

Only mount one temporary spare wheel. Do not drive faster than 50 mph. Take curves slowly. Do not use for a long period of time.

If your vehicle gets a flat tyre in the rear while towing another vehicle, mount the temporary spare wheel in the front and the full tyre in the rear.

Tyre chains ⇨ 176.

**Directional tyres**

Fit directional tyres such that they roll in the direction of travel. The rolling direction is indicated by a symbol (e.g. an arrow) on the sidewall.

The following applies to tyres fitted opposing the rolling direction:

- Driveability may be affected. Have the defective tyre renewed or repaired as soon as possible.
- Drive particularly carefully on wet and snow-covered road surfaces.

**Jump starting**

Do not start with quick charger.

A vehicle with a discharged battery can be started using jump leads and the battery of another vehicle.

**⚠ Warning**

Be extremely careful when starting with jump leads. Any deviation from the following instructions can lead to injuries or damage caused by battery explosion or damage to the electrical systems of both vehicles.

**⚠ Warning**

Avoid contact of the battery with eyes, skin, fabrics and painted surfaces. The fluid contains sulphuric acid which can cause injuries and damage in the event of direct contact.

- Never expose the battery to naked flames or sparks.

- A discharged battery can already freeze at a temperature of 0 °C. Defrost the frozen battery before connecting jump leads.
- Wear eye protection and protective clothing when handling a battery.
- Use a booster battery with the same voltage (12 volts). Its capacity (Ah) must not be much less than that of the discharged battery.
- Use jump leads with insulated terminals and a cross section of at least 16 mm<sup>2</sup> (25 mm<sup>2</sup> for diesel engines).
- Do not disconnect the discharged battery from the vehicle.
- Switch off all unnecessary electrical consumers.
- Do not lean over the battery during jump starting.
- Do not allow the terminals of one lead to touch those of the other lead.

- The vehicles must not come into contact with each other during the jump starting process.
- Apply the parking brake, transmission in neutral, automatic transmission in **P**.

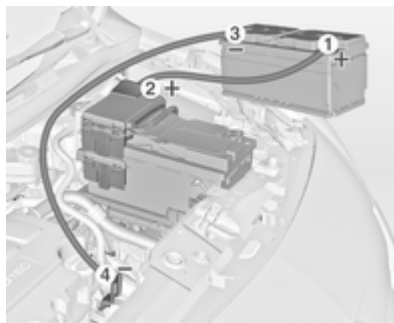

Lead connection order:

1. Connect the red lead to the positive terminal of the booster battery.
2. Connect the other end of the red lead to the positive terminal of the discharged battery.

3. Connect the black lead to the negative terminal of the booster battery.
4. Connect the other end of the black lead to a vehicle grounding point, such as the engine block or an engine mounting bolt. Connect as far away from the discharged battery as possible, however at least 60 cm.

Route the leads so that they cannot catch on rotating parts in the engine compartment.

To start the engine:

1. Start the engine of the vehicle providing the jump.
2. After 5 minutes, start the other engine. Start attempts should be made for no longer than 15 seconds at an interval of 1 minute.
3. Allow both engines to idle for approx. 3 minutes with the leads connected.

4. Switch on electrical consumers (e.g. headlights, heated rear window) of the vehicle receiving the jump start.
5. Reverse above sequence exactly when removing leads.

## Towing

### Towing the vehicle



Disengage cap at bottom and remove downwards.

The towing eye is stowed with the vehicle tools ⇨ 172.

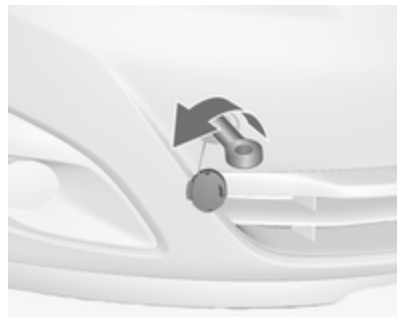

Screw in the towing eye as far as it will go until it stops in a horizontal position.

Attach a tow rope – or better still a tow rod – to the towing eye.

The towing eye must only be used for towing and not for recovering the vehicle.

#### Caution

Activate the child lock in both rear doors if the rear seats are occupied. Child locks ⇨ 24.

Switch on ignition to release steering wheel lock and to permit operation of brake lights, horn and windscreen wiper.

Transmission in neutral.

Switch on the hazard warning flashers on both vehicles.

### Caution

Drive slowly. Do not drive jerkily. Excessive tractive force can damage the vehicle.

When the engine is not running, considerably more force is needed to brake and steer.

To prevent the entry of exhaust gases from the towing vehicle, switch on the air recirculation and close the windows.

Vehicles with automatic transmission: The vehicle must be towed facing forwards, not faster than 50 mph nor further than 60 miles. In all other cases and when the transmission is defective, the front axle must be raised off the ground.

Seek the assistance of a workshop. After towing, unscrew the towing eye. Insert cap at the bottom and close cap.

## Towing another vehicle



Disengage the cap at the bottom and remove downwards.

The towing eye is stowed with the vehicle tools ↪ 172.

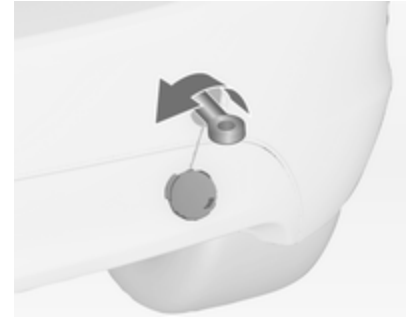

Screw in the towing eye as far as it will go until it stops in a horizontal position.

The lashing eye at the rear underneath the vehicle must never be used as a towing eye.

Attach a tow rope – or even better a tow bar – to the towing eye.

The towing eye must only be used for towing and not for recovering a vehicle.

Switch on the hazard warning flashers on both vehicles.

**Caution**

Drive slowly. Do not drive jerkily. Excessive tractive force can damage the vehicle.

After towing, unscrew the towing eye. Insert cap at the bottom and engage cap.

**Appearance care****Exterior care****Locks**

The locks are lubricated at the factory using a high quality lock cylinder grease. Use de-icing agent only when absolutely necessary, as this has a degreasing effect and impairs lock function. After using de-icing agent, have the locks regreased by a workshop.

**Washing**

The paintwork of your vehicle is exposed to environmental influences. Wash and wax your vehicle regularly. When using automatic vehicle washes, select a programme that includes waxing.

Bird droppings, dead insects, resin, pollen and the like should be cleaned off immediately, as they contain aggressive constituents which can cause paint damage.

If using a vehicle wash, comply with the vehicle wash manufacturer's instructions. The windscreen wiper and rear window wiper must be switched off. Remove antenna and external accessories such as roof racks etc.

If you wash your vehicle by hand, make sure that the insides of the wheel housings are also thoroughly rinsed out.

Clean edges and folds on opened doors and the bonnet as well as the areas they cover.

Have the door hinges of all doors greased by a workshop.

Do not clean the engine compartment with a steam-jet or high-pressure jet cleaner.

Thoroughly rinse and leather-off the vehicle. Rinse leather frequently. Use separate leathers for painted and glass surfaces: remnants of wax on the windows will impair vision.

## Exterior lights

Headlight and other light covers are made of plastic. Do not use any abrasive or caustic agents, do not use an ice scraper, and do not clean them dry.

## Polishing and waxing

Wax the vehicle regularly (at the latest when water no longer beads). Otherwise, the paintwork will dry out.

Polishing is necessary only if the paint has become dull or if solid deposits have become attached to it.

Paintwork polish with silicone forms a protective film, making waxing unnecessary.

Plastic body parts must not be treated with wax or polishing agents.

## Windows and windscreen wiper blades

Use a soft lint-free cloth or chamois leather together with window cleaner and insect remover.

When cleaning the rear window, make sure the heating element inside is not damaged.

For mechanical removal of ice, use a sharp-edged ice scraper. Press the scraper firmly against the glass so that no dirt can get under it and scratch the glass.

Clean smearing wiper blades with a soft cloth and window cleaner.

## Moonroof

Never clean with solvents or abrasive agents, fuels, aggressive media (e.g. paint cleaner, acetone-containing solutions etc.), acidic or highly alkaline media or abrasive pads. Do not apply wax or polishing agents to the middle part of the moonroof.

## Wheels and tyres

Do not use high-pressure jet cleaners.

Clean rims with a pH-neutral wheel cleaner.

Rims are painted and can be treated with the same agents as the body.

## Paintwork damage

Rectify minor paintwork damage with a touch-up pen before rust forms. Have more extensive damage or rust areas repaired by a workshop.

## Underbody

Some areas of the vehicle underbody have a PVC undercoating while other critical areas have a durable protective wax coating.

After the underbody is washed, check the underbody and have it waxed if necessary.

Bitumen/rubber materials could damage the PVC coating. Have underbody work carried out by a workshop.

Before and after winter, wash the underbody and have the protective wax coating checked.

## Towing equipment

Do not clean the coupling ball bar with a steam-jet or high-pressure jet cleaner.

### Rear carrier system

Clean the rear carrier system with a steam-jet or high-pressure jet cleaner at least once a year.

Operate the rear carrier system periodically if not in regular use, in particular during winter.

### Interior care

#### Interior and upholstery

Only clean the vehicle interior, including the instrument panel fascia and panelling, with a dry cloth or interior cleaner.

Clean the leather upholstery with clear water and a soft cloth. In case of heavy soiling, use leather care.

The instrument panel should only be cleaned using a soft damp cloth.

Clean fabric upholstery with a vacuum cleaner and brush.

Remove stains with an upholstery cleaner.

Clean seat belts with lukewarm water or interior cleaner.

Caution
<p>Close Velcro fasteners as open Velcro fasteners on clothing could damage seat upholstery.</p> <p>The same applies to clothing with sharp-edged objects, like zips or belts or studded jeans.</p>

#### Plastic and rubber parts

Plastic and rubber parts can be cleaned with the same cleaner as used to clean the body. Use interior cleaner if necessary. Do not use any other agent. Avoid solvents and petrol in particular. Do not use high-pressure jet cleaners.



## Service and maintenance

General information .....	191
Recommended fluids, lubricants and parts .....	192

### General information

#### Service information

In order to ensure economical and safe vehicle operation and to maintain the value of your vehicle, it is of vital importance that all maintenance work is carried out at the proper intervals as specified.

The detailed, up-to-date service schedule for your vehicle is available at the workshop.

Service display ⇨ 85.

#### European service intervals

Maintenance of your vehicle is required every 20000 miles or after 1 year, whichever occurs first, unless otherwise indicated in the service display.

The European service intervals are valid for the following countries:

Andorra, Austria, Belgium, Bosnia-Herzegovina, Bulgaria, Croatia, Cyprus, Czech Republic, Denmark, Estonia, Finland, France, Germany, Greece, Greenland, Hungary,

Iceland, Ireland, Israel, Italy, Latvia, Lithuania, Luxembourg, Macedonia, Malta, Montenegro, Netherlands, Norway, Poland, Portugal, Romania, Slovakia, Slovenia, Spain, Sweden, Switzerland, United Kingdom.

Service display ⇨ 85.

#### International service intervals

Maintenance of your vehicle is required every 10000 miles or after 1 year, whichever occurs first, unless otherwise indicated in the service display.

The international service intervals are valid for the countries which are not listed in the European service intervals.

Service display ⇨ 85.

#### Confirmations

Confirmation of service is recorded in the Service and Warranty Booklet.

The date and mileage is completed with the stamp and signature of the servicing workshop.

Make sure that the Service and Warranty Booklet is completed correctly as continuous proof of service is essential if any warranty or goodwill claims are to be met, and is also a benefit when selling the vehicle.

### Service interval with remaining engine oil life duration

The service interval is based on several parameters depending on usage.

The service display lets you know when to change the engine oil.

Service display ⇨ 85.

## Recommended fluids, lubricants and parts

### Recommended fluids and lubricants

Only use products that meet the recommended specifications. Damage resulting from the use of products not in line with these specifications will not be covered by the warranty.

#### Warning

Operating materials are hazardous and could be poisonous. Handle with care. Pay attention to information given on the containers.

### Engine oil

Engine oil is identified by its quality and its viscosity. Quality is more important than viscosity when selecting which engine oil to use. The oil quality ensures e.g. engine cleanliness, wear protection and oil

aging control, whereas viscosity grade gives information on the oil's thickness over a temperature range.

Dexos is the newest engine oil quality that provides optimum protection for gasoline and diesel engines. If it is unavailable, engine oils of other listed qualities have to be used.

Recommendations for gasoline engines are also valid for Compressed Natural Gas (CNG), Liquefied Petroleum Gas (LPG) and Ethanol (E85) fuelled engines.

Select the appropriate engine oil based on its quality and on the minimum ambient temperature ⇨ 196.

### Topping up engine oil

Engine oils of different manufacturers and brands can be mixed as long as they comply with the required engine oil quality and viscosity.

Use of engine oil with only ACEA A1/B1 or only A5/B5 quality is prohibited, since it can cause long-term engine damage under certain operating conditions.

Select the appropriate engine oil based on its quality and on the minimum ambient temperature ↻ 196.

### **Additional engine oil additives**

The use of additional engine oil additives could cause damage and invalidate the warranty.

### **Engine oil viscosity grades**

The SAE viscosity grade gives information of the thickness of the oil.

Multigrade oil is indicated by two figures, e.g. SAE 5W-30. The first figure, followed by a W, indicates the low temperature viscosity and the second figure the high temperature viscosity.

Select the appropriate viscosity grade depending on the minimum ambient temperature ↻ 196.

All of the recommended viscosity grades are suitable for high ambient temperatures.

### **Coolant and antifreeze**

Use only silicate-free long life coolant (LLC) antifreeze.

The system is factory filled with coolant designed for excellent corrosion protection and frost protection down to approx. -28 °C. This concentration should be maintained all year round. The use of additional coolant additives that intend to give additional corrosion protection or seal against minor leaks can cause function problems. Liability for consequences resulting from the use of additional coolant additives will be rejected.

### **Brake and clutch fluid**

Only use high-performance brake fluid approved for the vehicle, consult a workshop.

Over time, brake fluid absorbs moisture which will reduce braking effectiveness. The brake fluid should therefore be replaced at the specified interval.

Brake fluid should be stored in a sealed container to avoid water absorption.

Ensure brake fluid does not become contaminated.

## Technical data

Vehicle identification .....	194
Vehicle data .....	196

## Vehicle identification

### Vehicle Identification Number



The Vehicle Identification Number is stamped on the identification plate and on the floor pan, under the floor covering, visible under a cover.

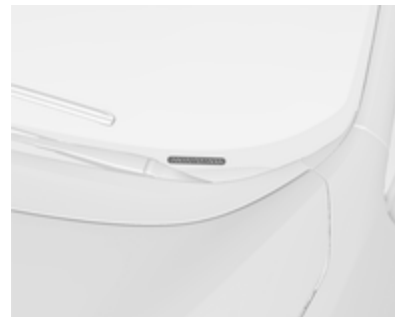

The Vehicle Identification Number may be embossed on the instrument panel visible through the windscreen.

## Identification plate



The identification plate is located on the rear right-hand door frame.



Information on identification label:

- 1 = Manufacturer
- 2 = Type approval number
- 3 = Vehicle Identification Number
- 4 = Permissible gross vehicle weight rating in kg
- 5 = Permissible gross train weight in kg
- 6 = Maximum permissible front axle load in kg
- 7 = Maximum permissible rear axle load in kg
- 8 = Vehicle-specific or country-specific data

The combined total of front and rear axle loads must not exceed the permissible gross vehicle weight. For example, if the front axle is bearing its maximum permissible load, the rear axle can only bear a load that is equal to the gross vehicle weight minus the front axle load.

The technical data is determined in accordance with European Community standards. We reserve the right to make modifications.

Specifications in the vehicle documents always have priority over those given in this manual.

## Vehicle data

### Recommended fluids and lubricants

#### European service schedule

#### Required engine oil quality

Engine oil quality	All European countries (except Belarus, Moldova, Russia, Serbia, Turkey)		Only Israel	
	Petrol engines (including CNG, LPG, E85)	Diesel engines	Petrol engines (including CNG, LPG, E85)	Diesel engines
<b>dexos 1</b>	–	–	✓	–
<b>dexos 2</b>	✓	✓	–	✓

In case dexos quality is unavailable you may use max. 1 litre engine oil quality ACEA C3 for topping up once between each oil change.

#### Engine oil viscosity grades

All European countries and Israel (except Belarus, Moldova, Russia, Serbia, Turkey)	
Ambient temperature	Petrol and diesel engines
down to -25 °C	SAE 5W-30 or SAE 5W-40
below -25 °C	SAE 0W-30 or SAE 0W-40

## International service schedule

### Required engine oil quality

Engine oil quality	All countries outside Europe except Israel		Only Belarus, Moldova, Russia, Serbia, Turkey	
	Petrol engines (including CNG, LPG, E85)	Diesel engines	Petrol engines (including CNG, LPG, E85)	Diesel engines
<b>dexos 1</b>	✓	–	–	–
<b>dexos 2</b>	–	✓	✓	✓

In case dexos quality is unavailable you may use the oil qualities listed below:

Engine oil quality	All countries outside Europe except Israel		Only Belarus, Moldova, Russia, Serbia, Turkey	
	Petrol engines (including CNG, LPG, E85)	Diesel engines	Petrol engines (including CNG, LPG, E85)	Diesel engines
GM-LL-A-025	✓	–	✓	–
GM-LL-B-025	–	✓	–	✓

Engine oil quality	All countries outside Europe except Israel		Only Belarus, Moldova, Russia, Serbia, Turkey	
	Petrol engines (including CNG, LPG, E85)	Diesel engines	Petrol engines (including CNG, LPG, E85)	Diesel engines
ACEA A3/B3	✓	–	✓	–
ACEA A3/B4	✓	✓	✓	✓
ACEA C3	✓	✓	✓	✓
API SM	✓	–	✓	–
API SN resource conserving	✓	–	✓	–

### Engine oil viscosity grades

All countries outside Europe (except Israel), including Belarus, Moldova, Russia, Serbia, Turkey	
Ambient temperature	Petrol and diesel engines
down to -25 °C	SAE 5W-30 or SAE 5W-40
below -25 °C	SAE 0W-30 or SAE 0W-40
down to -20 °C	SAE 10W-30 <sup>1)</sup> or SAE 10W-40 <sup>1)</sup>

<sup>1)</sup> Permitted, but usage of SAE 5W-30 or SAE 5W-40 with dexos quality is recommended.



## Engine data

Sales designation	1.4	1.4	1.4	1.3
Engine identifier code	A14XER	A14NEL	A14NET	A13DTC
Number of cylinders	4	4	4	4
Piston displacement [cm <sup>3</sup> ]	1398	1364	1364	1248
Engine power [kW]	74	88	103	55
at rpm	6000	4800-6000	4900-6000	4000
Torque [Nm]	130	175	200	180
at rpm	4000	1750-4800	1850-4900	1750-2500
Fuel type	Petrol	Petrol/LPG	Petrol	Diesel
Octane rating RON				
recommended	<b>95</b>	<b>95</b>	<b>95</b>	
possible	98	98	98	
possible	91	91	91	
Oil consumption [l/1000 km]	0.6	0.6	0.6	0.6

## 200 Technical data

<b>Sales designation</b>	<b>1.3</b>	<b>1.7</b>	<b>1.7</b>	<b>1.7</b>
<b>Engine identifier code</b>	<b>A13DTE</b>	<b>A17DT</b>	<b>A17DTC</b>	<b>A17DTS</b>
Number of cylinders	4	4	4	4
Piston displacement [cm <sup>3</sup> ]	1248	1686	1686	1686
Engine power [kW]	70	74	81	96
at rpm	4000	4000	4000	4000
Torque [Nm]	180	260	280	300
at rpm	1750-3500	1700-2550	1700-2500	2000-2500
Fuel type	Diesel	Diesel	Diesel	Diesel
Oil consumption [l/1000 km]	0.6	0.6	0.6	0.6

## Performance

<b>Engine</b>	<b>A14XER</b>	<b>A14NEL</b>	<b>A14NET</b>	<b>A13DTC</b>
Maximum speed <sup>2)</sup> [mph]				
Manual transmission	110	117	122	99
Automatic transmission	–	–	–	–

<sup>2)</sup> The maximum speed indicated is achievable at kerb weight (without driver) plus 200 kg payload. Optional equipment could reduce the specified maximum speed of the vehicle.

Engine	A13DTE	A17DT	A17DTC	A17DTS
Maximum speed <sup>3)</sup> [mph]				
Manual transmission	104	–	113	106
Automatic transmission	–	107	–	–

<sup>3)</sup> The maximum speed indicated is achievable at kerb weight (without driver) plus 200 kg payload. Optional equipment could reduce the specified maximum speed of the vehicle.

## Vehicle weight

Kerb weight, basic model without any optional equipment

	Engine	Manual transmission	Automatic transmission
without/with air conditioning [kg]	A14XER	1361/1376	–
	A14NEL	1393 <sup>4)</sup> /1408 <sup>4)</sup>	–
	A14NET	1393/1408	–
	A13DTC	1393/1408	–
	A13DTE	1393/1408	–
	A17DT	–	1503/1518
	A17DTC	1503/1518	1503/1518
	A17DTS	1503/1518	–

<sup>4)</sup> With LPG engine weight increased by 77 kg.

### Kerb weight, basic model with all optional equipment

	Engine	Manual transmission	Automatic transmission
without/with air conditioning [kg]	A14XER	-/1571	-
	A14NEL	-/1613	-
	A14NET	-/1613	-
	A13DTC	-/1613	-
	A13DTE	-/1471	-
	A17DT	-	-/1701
	A17DTC	-/1664 <sup>5)</sup>	-/1701
	A17DTS	-/1664 <sup>5)</sup>	-

### Vehicle dimensions

Length [mm]	4288
Width without exterior mirrors [mm]	1812
Width with two exterior mirrors [mm]	1994
Height (without antenna) [mm]	1615

<sup>5)</sup> With stop-start system the weight is increased by 37 kg.

---

---

Length of load compartment floor [mm]	815
Length of load compartment with folded rear seats [mm]	1642
Load compartment width [mm]	1038
Load compartment height [mm]	803
Height of load compartment opening	791
Wheelbase [mm]	2644
Turning circle diameter [m]	11.1

---

## Capacities

### Engine oil

<b>Engine</b>	<b>A14XER</b>	<b>A14NEL</b>	<b>A14NET</b>	<b>A13DTC</b>
including Filter [l]	4.0	4.0	4.0	3.2
between MIN and MAX [l]	1.0	1.0	1.0	1.0

---

<b>Engine</b>	<b>A13DTE</b>	<b>A17DT</b>	<b>A17DTC</b>	<b>A17DTS</b>
including Filter [l]	3.2	5.4	5.4	5.4
between MIN and MAX [l]	1.0	1.0	1.0	1.0

---

## Fuel tank

Petrol/diesel, nominal capacity [l]

54

LPG, nominal capacity [l]

48<sup>6)</sup>

## Tyre pressures

Engine	Tyres	Comfort with up to 3 people		ECO with up to 3 people		With full load	
		front	rear	front	rear	front	rear
		[kPa/bar] ([psi])	[kPa/bar] ([psi])	[kPa/bar] ([psi])	[kPa/bar] ([psi])	[kPa/bar] ([psi])	[kPa/bar] ([psi])
A14XER	195/65 R15, 205/55 R16, 225/45 R17	230/2.3 (33)	210/2.1 (30)	280/2.8 (41)	260/2.6 (38)	250/2.5 (36)	320/3.2 (46)
	225/40 R18 <sup>7)</sup>	230/2.3 (33)	210/2.1 (30)	–	–	250/2.5 (36)	320/3.2 (46)
A14NEL	195/65 R15, 205/55 R16, 225/45 R17	230/2.3 (33)	210/2.1 (30)	280/2.8 (41)	260/2.6 (38)	250/2.5 (36)	320/3.2 (46)
	225/40 R18 <sup>7)</sup>	250/2.5 (36)	230/2.3 (33)	–	–	270/2.7 (39)	320/3.2 (46)

6) Fillable to 80% percent of its capacity.

7) With reduced steering angle.

Engine	Tyres	Comfort with up to 3 people		ECO with up to 3 people		With full load	
		front [kPa/bar] ([psi])	rear [kPa/bar] ([psi])	front [kPa/bar] ([psi])	rear [kPa/bar] ([psi])	front [kPa/bar] ([psi])	rear [kPa/bar] ([psi])
A14NET	205/55 R16, 225/45 R17	230/2.3 (33)	210/2.1 (30)	280/2.8 (41)	260/2.6 (38)	250/2.5 (36)	320/3.2 (46)
	225/40 R18 <sup>7)</sup>	250/2.5 (36)	230/2.3 (33)	–	–	270/2.7 (39)	320/3.2 (46)
A13DTC	195/65 R15, 205/55 R16, 225/45 R17	230/2.3 (33)	210/2.1 (30)	280/2.8 (41)	260/2.6 (38)	250/2.5 (36)	320/3.2 (46)
	225/40 R18 <sup>7)</sup>	230/2.3 (33)	210/2.1 (30)	–	–	250/2.5 (36)	320/3.2 (46)
A13DTE	195/65 R15, 205/55 R16, 225/45 R17	230/2.3 (33)	210/2.1 (30)	280/2.8 (41)	260/2.6 (38)	250/2.5 (36)	320/3.2 (46)
	225/40 R18 <sup>7)</sup>	230/2.3 (33)	210/2.1 (30)	–	–	250/2.5 (36)	320/3.2 (46)

<sup>7)</sup> With reduced steering angle.



Engine	Tyres	Comfort with up to 3 people		ECO with up to 3 people		With full load	
		front	rear	front	rear	front	rear
		[kPa/bar] ([psi])	[kPa/bar] ([psi])	[kPa/bar] ([psi])	[kPa/bar] ([psi])	[kPa/bar] ([psi])	[kPa/bar] ([psi])
A17DT, A17DTC, A17DTS	195/65 R15 <sup>8)</sup> , 205/55 R16, 225/45 R17	250/2.5 (36)	230/2.3 (33)	300/3.0 (43)	280/2.8 (41)	270/2.7 (39)	320/3.2 (46)
	225/40 R18 <sup>7)</sup>	270/2.7 (39)	250/2.5 (36)	–	–	280/2.8 (41)	320/3.2 (46)
All	Temporary spare wheel	420/4.2 (61)	420/4.2 (61)	–	–	420/4.2 (61)	420/4.2 (61)

8) Only permitted in combination with weight reduction package.

9) Only permitted with A17DT and A17DTC.

7) With reduced steering angle.

## Towing hitch installation dimensions

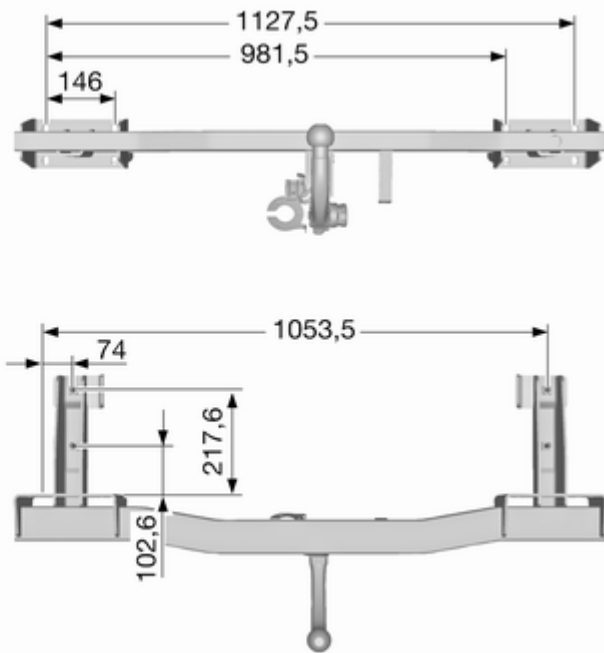
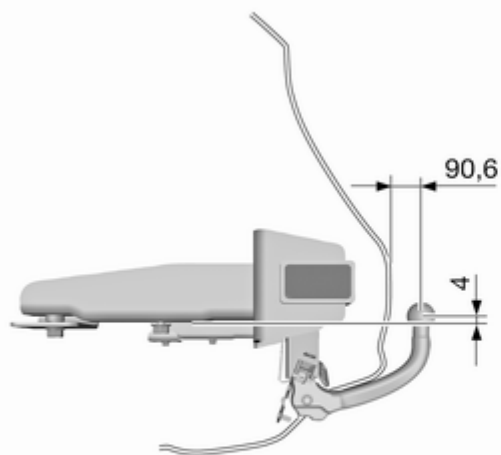

## Customer information

Vehicle data recording and  
privacy ..... 209

### Vehicle data recording and privacy

#### Event data recorders

The vehicle has a number of sophisticated systems that monitor and control several vehicle data. Some data may be stored during regular operation to facilitate repair of detected malfunctions, other data is stored only in a crash or near crash event by modules in your vehicle systems that have an event data recording function such as the airbag control module.

The systems may record diagnostic data about the condition of the vehicle (e.g. oil level or vehicle mileage) and information how it was operated (e.g. engine speed, brake application and seat belt usage).

To read this data, special equipment and access to the vehicle is required. Some diagnostic data is electronically fed into Vauxhall global systems when the vehicle is serviced in a workshop, in order to document the

service history of the vehicle. This enables the workshop to offer you efficient maintenance and repair, tailored to your individual vehicle, each time you bring it back to the workshop.

The manufacturer will not access driver's behavior related information about a crash event or share it with others except:

- with the consent of the vehicle owner or, if the vehicle is leased, of the lessee
- in response to an official request of police or similar government office
- as part of the manufacturer's defense in case of legal proceedings
- as required by law

In addition, the manufacturer may use the collected or received diagnostic data:

- for the manufacturer's research needs
- to make it available for research needs where appropriate confidentiality is maintained and need is shown
- to share summary data which is not tied to a specific vehicle with other organisations for research purposes

## **Radio Frequency Identification (RFID)**

RFID technology is used in some vehicles for functions such as tyre pressure monitoring and ignition system security. It is also used in connection with conveniences such as radio remote controls for door locking/unlocking and starting, and in-vehicle transmitters for garage door openers. RFID technology in Vauxhall vehicles does not use or record personal information or link with any other Vauxhall system containing personal information.



# Index

<b>A</b>		Automatic transmission .....	132
Accessories and vehicle modifications .....	150	Auxiliary heater .....	122
Active head restraints.....	35	<b>B</b>	
Adaptive brake light.....	136	Battery .....	155
Adaptive forward lighting .....		Battery discharge protection .....	116
.....	93, 111, 160	Battery, jump starting.....	184
Adjustable air vents .....	123	Battery voltage .....	101
Airbag and belt tensioners .....	88	Belts.....	43
Airbag deactivation .....	49, 89	Bicycle rack.....	60
Airbag system .....	46	Bonnet .....	151
Air conditioning regular operation .....	124	Brake and clutch fluid.....	192
Air conditioning system .....	118	Brake and clutch system .....	89
Air intake .....	123	Brake assist .....	138
Air vents.....	123	Brake fluid .....	154
Alert.....	101	Brakes .....	136, 154
Antifreeze.....	153	Breakdown.....	186
Antilock brake system .....	136	Bulb replacement .....	157
Antilock brake system (ABS) .....	90	<b>C</b>	
Anti-theft alarm system .....	27	Capacities .....	204
Anti-theft locking system .....	26	Car Pass .....	19
Appearance care.....	188	Catalytic converter .....	131
Armrest.....	39	Central locking system .....	21
Armrest storage .....	60	Centre console lighting .....	115
Ashtrays .....	83	Changing tyre and wheel size ...	175
Automatic anti-dazzle .....	30	Charging system .....	89
Automatic light control .....	109	Child locks .....	24
Automatic locking .....	24, 93	Child restraint installation locations .....	53

Child restraint systems .....	50	Driver Information Centre.....	94	Exterior care .....	188
Cigarette lighter .....	83	Driving characteristics and		Exterior light .....	93
Climate control .....	15	towing tips .....	146	Exterior lighting .....	12, 108
Climate control, service.....	124	Driving hints.....	125	Exterior mirrors.....	28
Climate control systems.....	117				
Clock .....	81	<b>E</b>		<b>F</b>	
Code.....	98	Electric adjustment .....	28	Fault .....	134
Control indicators.....	86	Electrical parking brake .....	90	First aid.....	74
Control of the vehicle .....	125	Electrical parking brake fault .....	90	First aid kit .....	74
Controls.....	77	Electrical system.....	166	Fixed air vents .....	123
Controls in steering wheel.....	77	Electronic climate control		Flex-Fix system.....	60
Convex shape .....	28	system .....	119	Fog light .....	93
Coolant.....	153	Electronic driving programmes ..	134	Fog lights.....	112, 162
Coolant and antifreeze.....	192	Electronic Stability Control.....	139	Folding .....	29
Coolant temperature gauge.....	85	Electronic Stability Control and		Folding tray .....	74
Coupling ball bar.....	147	Traction Control system.....	91	Front airbag system .....	47
Cruise control .....	93, 140	Electronic Stability Control off .....	91	Front fog lights .....	112
Cupholders .....	57	End-of-life vehicle recovery .....	151	Front seats.....	36
Curtain airbag system .....	48	Engine compartment fuse box ..	168	Front storage .....	59
Curve lighting.....	111	Engine coolant .....	153	Front turn signal light.....	157
		Engine coolant temperature		Fuel.....	143
<b>D</b>		gauge .....	85	Fuel consumption - CO <sub>2</sub> -	
Danger, Warnings and Cautions ...	3	Engine data .....	199	Emissions .....	145
Dashboard.....	10	Engine exhaust .....	130	Fuel for diesel engines .....	144
Daytime running light.....	109	Engine oil .....	152, 192, 196	Fuel for petrol engines .....	143
Deflation detection system .....	92	Engine oil pressure .....	92	Fuel gauge .....	85
Diesel fuel system bleeding .....	156	Entry lighting .....	115	Fuse box.....	168
Diesel particle filter.....	91, 130	Event data recorders.....	209	Fuses .....	166
Door open .....	93	Exhaust gases.....	130		
Doors.....	25	Exit lighting .....	115		

**G**

Gauges.....	84
General information .....	146
Glovebox .....	57
Graphic-Info-Display, Colour-Info-Display .....	96

**H**

Halogen headlights .....	157
Hand brake.....	136, 137
Hazard warning flashers .....	111
Headlight flash .....	109
Headlight range adjustment .....	109
Headlights.....	108, 109
Headlights when driving abroad .....	110
Head restraint adjustment .....	8
Head restraints .....	34
Heated .....	29
Heated rear window .....	32
Heated steering wheel .....	78
Heating .....	40
Heating and ventilation system .....	117
High beam .....	93, 109
Hill start assist .....	138
Horn .....	13, 78

**I**

Identification plate .....	195
Ignition switch positions .....	126
Immobiliser .....	28, 93

Indicators.....	84
Information displays.....	94
Instrument cluster .....	84
Instrument panel fuse box .....	170
Instrument panel illumination .....	166
Instrument panel illumination control .....	113
Instrument panel overview .....	10
Interior care .....	190
Interior lighting.....	113
Interior lights .....	114, 165
Interior mirrors.....	29
Interruption of power supply .....	134
Introduction .....	3
ISOFIX child restraint systems .....	56

**J**

Jump starting .....	184
---------------------	-----

**K**

Keys .....	19
Keys, locks.....	19
Keys, memorised settings.....	21

**L**

Lashing eyes .....	72
Light covers, misted.....	113
Lighting features.....	115
Light switch .....	108
Load compartment .....	25, 69

Load compartment cover .....	70
Load compartment fuse box .....	171
Loading information .....	75
Low fuel .....	92

**M**

Malfunction indicator light .....	89
Manual anti-dazzle .....	29
Manual mode .....	133
Manual transmission .....	135
Manual windows .....	30
Memorised settings.....	21
Messages.....	98
Mirror adjustment .....	8
Misted light covers .....	113
Moonroof .....	33

**N**

New vehicle running-in .....	126
Number plate light .....	165

**O**

Object detection systems.....	141
Octane rating.....	199
Odometer .....	84
Oil.....	152
Oil, engine.....	192, 196
Oil pressure.....	92
Outside temperature .....	81
Overrun cut-off .....	127



<b>P</b>			
Parking .....	17, 130	Rear window wiper/washer .....	80
Parking assist .....	141	Recommended fluids and lubricants .....	192, 196
Parking brake .....	137	Reduced engine power .....	93
Parking lights .....	113	Refuelling .....	144
Particulate filter .....	130	Remote control .....	20
Performance .....	200	Retained power off .....	126
Performing work .....	151	Reversing lights .....	113
Personalisation .....	103	Ride control systems .....	138
Pollen filter .....	123	Roof .....	33
Power outlets .....	82	Roof rack .....	75
Power windows .....	30	<b>S</b>	
Preheating .....	91	Safety belts .....	43
Puncture .....	179	Safety net .....	72
<b>Q</b>		Seat adjustment .....	6, 36
Quickheat .....	122	Seat belt .....	8
<b>R</b>		Seat belt reminder .....	88
Radio Frequency Identification (RFID) .....	210	Seat belts .....	43
Radio remote control .....	20	Seat heating .....	40
Reading lights .....	114	Seat position .....	36
Rear carrier system .....	60	Selector lever .....	132
Rear doors .....	25	Service .....	124, 191
Rear floor storage cover .....	71	Service display .....	85
Rear fog light .....	93	Service information .....	191
Rear fog lights .....	112	Service vehicle soon .....	89
Rear seats .....	39, 41	Side airbag system .....	48
Rear storage .....	70	Sidelights .....	108
		Side turn signal lights .....	165
		Spare wheel .....	182
		Speedometer .....	84
		Starting and operating .....	126
		Starting off .....	16
		Starting the engine .....	126
		Steering wheel adjustment .....	9, 77
		Steering wheel controls .....	77
		Steering wheel, heated .....	78
		Stop-start system .....	128
		Storage .....	57
		Storage compartments .....	57
		Sunglasses storage .....	59
		Sunvisor lights .....	114
		Sun visors .....	32
		Symbols .....	4
		<b>T</b>	
		Tachometer .....	84
		Tailgate .....	25
		Tail lights .....	163
		Technical data .....	199
		Three-point seat belt .....	44
		Tools .....	172
		Top-tether fastening eyes .....	56
		Towing .....	146, 186
		Towing another vehicle .....	187
		Towing a trailer .....	146
		Towing equipment .....	147
		Towing hitch installation dimensions .....	208
		Towing the vehicle .....	186

Traction Control system .....	138
Traction Control system off .....	91
Trailer coupling.....	146
Trailer towing .....	146
Transmission .....	16
Transmission display .....	132
Tread depth .....	174
Trip computer .....	102
Trip odometer .....	84
Tunnel detection.....	109
Turn and lane-change signals ...	112
Turn signal .....	88
Tyre chains .....	176
Tyre deflation detection system .	174
Tyre designations .....	173
Tyre pressure .....	173
Tyre pressures .....	205
Tyre repair kit .....	176
Tyres and wheel size, changing.	175

## U

Ultrasonic parking assist .....	91
Underseat storage .....	59
Upholstery, cleaning.....	190
Upshift.....	90
Using this manual .....	3

## V

Variable effort steering.....	91
Vehicle checks.....	151

Vehicle data.....	196
Vehicle data recording and privacy.....	209
Vehicle dimensions .....	203
Vehicle Identification Number ...	194
Vehicle jack.....	172
Vehicle messages .....	98
Vehicle personalisation .....	103
Vehicle security.....	26
Vehicle specific data .....	3
Vehicle storage.....	150
Vehicle tools.....	172
Vehicle unlocking .....	6
Vehicle weight .....	202
Ventilation.....	117

## W

Warning chimes .....	101
Warning lights.....	84
Warning triangle .....	74
Washer and wiper systems .....	14
Washer fluid .....	154
Welcome lighting.....	115
Wheel changing .....	179
Wheel covers .....	175
Wheels and tyres .....	173
Windows.....	30
Windscreen.....	30
Windscreen wiper/washer .....	79

Winter tyres .....	173
Wiper blade replacement .....	157

Copyright by General Motors UK Ltd.

The information contained in this publication is effective as of the date indicated below. General Motors UK Ltd. reserves the right to make changes to the technical specifications, features and design of the vehicles relative to the information contained in this publication, as well as changes to the publication itself.

Edition: June 2011, General Motors UK Ltd.

Printed on chlorine-free bleached paper.

2690/3-en TS-Number

June 2011

