

MOVANO

Owner's Manual



VAUXHALL

Contents

Introduction	2
In brief	6
Keys, doors and windows	19
Seats, restraints	44
Storage	72
Instruments and controls	83
Lighting	109
Infotainment system	117
Climate control	207
Driving and operating	223
Vehicle care	267
Service and maintenance	310
Technical data	313
Customer information	317
Body conversions	325
Index	340

Introduction

Fuel	Designation	<input type="text"/>		
Engine oil	Grade	<input type="text"/>		
	Viscosity	<input type="text"/>		
Tyre pressure	Tyre size		Front	Rear
	Summer tyres	<input type="text"/>	<input type="text"/>	<input type="text"/>
	Winter tyres	<input type="text"/>	<input type="text"/>	<input type="text"/>
Weights	Gross vehicle weight rating	<input type="text"/>		
	- Kerb weight, basic model	<input type="text"/>		
	= Loading	<input type="text"/>		

Vehicle specific data

Please enter your vehicle's data on the previous page to keep it easily accessible.

Refer to the sections "Service and maintenance", "Technical data", the vehicle's identification plate and national registration documents.

Introduction

Your vehicle is a designed combination of advanced technology, safety, environmental friendliness and economy.

This Owner's Manual provides you with all the necessary information to enable you to drive your vehicle safely and efficiently.

Make sure your passengers are aware of the possible risk of accident and injury which may result from improper use of the vehicle.

You must always comply with the specific laws and regulations of the country that you are in. These laws may differ from the information in this Owner's Manual.

Disregarding the description given in this manual may affect your warranty.

When this Owner's Manual refers to a workshop visit, we recommend your Vauxhall Authorised Repairer.

All Vauxhall Authorised Repairers provide first-class service at reasonable prices. Experienced mechanics trained by Vauxhall work according to specific Vauxhall instructions.

The customer literature pack should always be kept ready to hand in the vehicle.

Using this manual

- This manual describes all options and features available for this model. **Certain descriptions, including those for display and menu functions, may not apply to your vehicle due to model variant, country specifications, special equipment or accessories.**
- The "In brief" section will give you an initial overview.

- The table of contents at the beginning of this manual and within each section shows where the information is located.
- The index will enable you to search for specific information.
- This Owner's Manual depicts left-hand drive vehicles. Operation is similar for right-hand drive vehicles.
- The Owner's Manual uses the factory engine designations. The corresponding sales designations can be found in the section "Technical data".
- Directional data, e.g. left or right, or front or back, always relate to the direction of travel.
- The vehicle display screens may not support your specific language.
- Display messages and interior labelling are written in **bold** letters.

Danger, Warnings and Cautions

⚠ Danger

Text marked **⚠ Danger** provides information on risk of fatal injury. Disregarding this information may endanger life.

⚠ Warning

Text marked **⚠ Warning** provides information on risk of accident or injury. Disregarding this information may lead to injury.

Caution

Text marked **Caution** provides information on possible damage to the vehicle. Disregarding this information may lead to vehicle damage.

Symbols

Page references are indicated with ⇨.
⇨ means "see page".

Page references and index entries refer to the indented headings given in the section table of content.

Thank you for choosing a Vauxhall.

We wish you many hours of pleasurable driving.

Your Vauxhall Team

In brief

Initial drive information

Vehicle unlocking

Unlocking with key

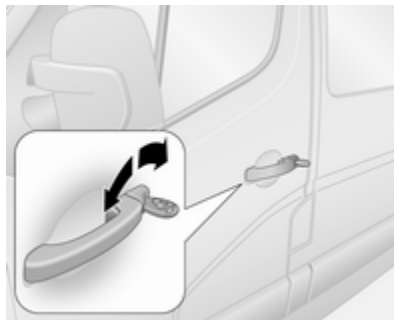

Turn the key in the driver's door lock.
Open the doors by pulling the handles.

Unlocking with remote control



Depending on vehicle configuration:
Press  to unlock the front doors.
Press again to unlock entire vehicle.
Open the doors by pulling the handles.

With 3-button remote control, press . Only the load compartment is unlocked.

Radio remote control ⇨ 20.

Central locking system ⇨ 23.

Anti-theft alarm system ⇨ 35.

Unlocking with electronic key

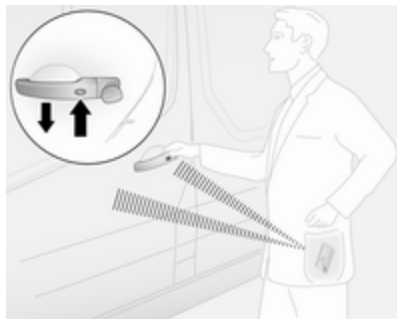

Press the button on any exterior door handle when the electronic key is within range of the detection zone (approx. 1 m of the front doors or load compartment) and pull the handle to open.

Electronic key system ⇨ 21.

Seat adjustment

Longitudinal adjustment

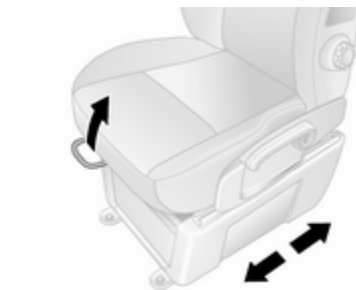

Pull handle, slide seat, release handle.

Try to move the seat back and forth to ensure that the seat is locked in place.

Seat position ⇨ 45.

Seat adjustment ⇨ 46.

Backrests inclination

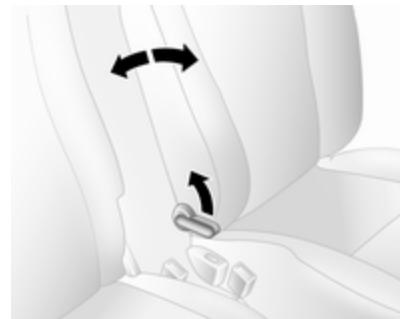

Pull lever, adjust inclination and release lever. Allow the seat to engage audibly.

Seat position ⇨ 45.

Seat adjustment ⇨ 46.

Seat height



Lever motion

up : seat higher
down : seat lower

Seat position ⇨ 45.

Seat adjustment ⇨ 46.

Head restraint adjustment

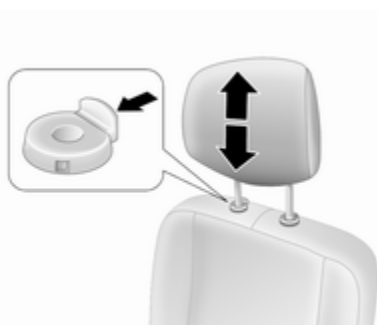

Press release button, adjust height, engage.

Head restraints ⇨ 44.

Seat belt



Pull out the seat belt and fasten in belt buckle. The seat belt must not be twisted and must fit close against the body. The backrest must not be tilted back too far (maximum approx. 25 °).

To unfasten belt, press red button on belt buckle.

Seat position ⇨ 45.

Seat belts ⇨ 54.

Airbag system ⇨ 58.

Mirror adjustment

Interior mirror

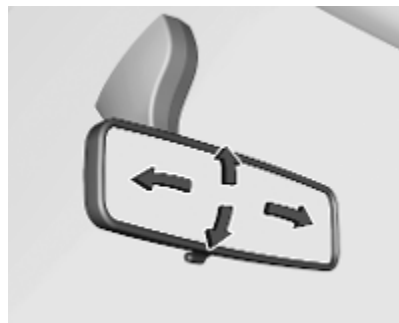

To adjust the mirror, move the mirror housing in the desired direction.

Interior mirror, wide view mirror
↻ 39.

Rear view display ↻ 40.

Exterior mirrors

Manual adjustment

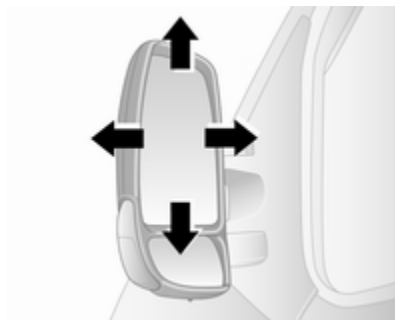

Swivel mirror in required direction.

Exterior mirrors ↻ 38.

Electric adjustment



Select the relevant exterior mirror and adjust it by swivelling the control.

Convex exterior mirrors ↻ 38.

Electric adjustment ↻ 38.

Folding exterior mirrors ↻ 38.

Heated exterior mirrors ↻ 39.

Steering wheel adjustment

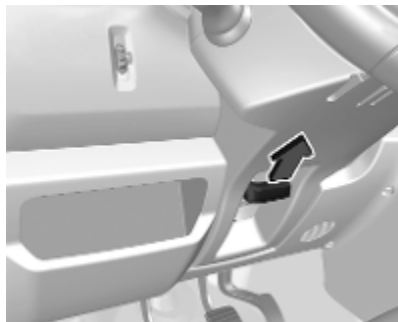

Unlock lever, adjust steering wheel, then engage lever and ensure it is fully locked.

Do not adjust steering wheel unless vehicle is stationary and steering wheel lock has been released.

Airbag system ⇨ 58.

Ignition positions ⇨ 225.

Instrument panel overview

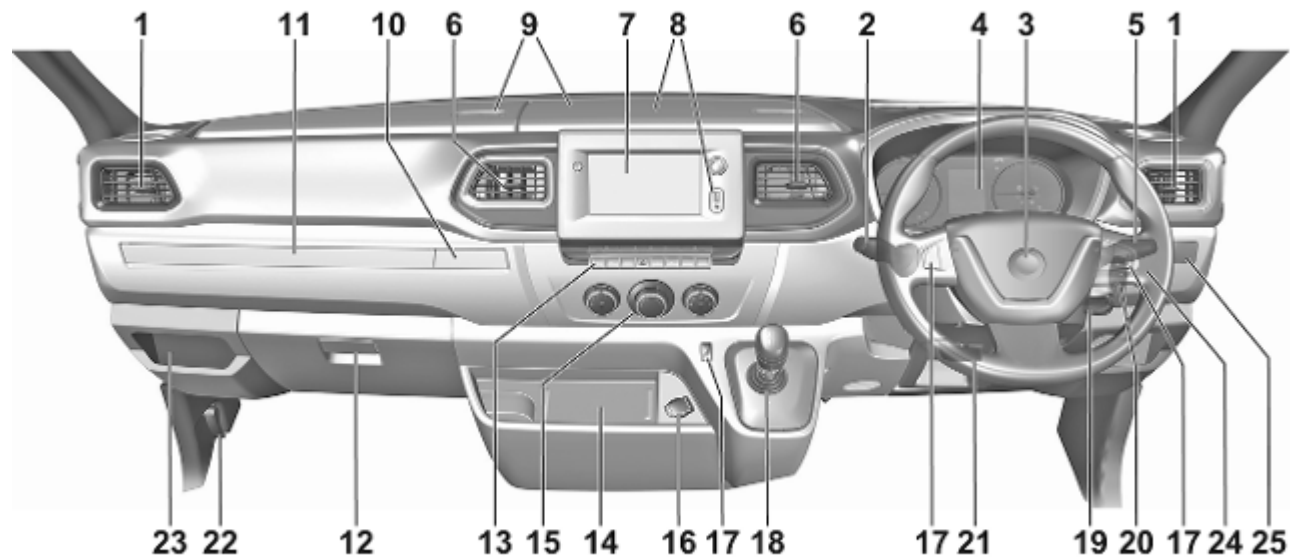

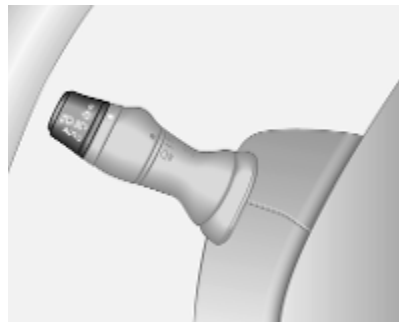

1	Side air vents	220	10	Cupholder	73	20	Infotainment controls	
2	Light switch	109	11	Tray	72	21	Steering wheel adjustment . .	84
	Turn lights	112	12	Glovebox	73	22	Bonnet release lever	269
	Front / rear fog lights	112	13	Parking assist	254	23	Fuse box	286
	Headlight flash	111		Lane departure warning	260	24	Headlight range adjustment	111
	High beam	110		Electronic Stability Control and Traction Control	246	25	Power take-off	265
	High beam assist	110		Hazard warning flashers	112		Idle speed control	227
	Exit lighting	115		Central locking system	23		Laden mode kg	242
3	Horn	84		Stop-start system	227			
	Driver airbag	61		Side blind spot alert	256			
4	Instruments	90		ECO mode	224			
	Driver Information Centre	104	14	Inductive charging	89			
5	Windscreen wiper and washer, rear wiper and washer	85	15	Climate control system	207			
	Buttons for Driver Information Centre	104	16	Power outlet	87			
6	Air vents	220	17	Cruise control	248			
7	Info Display	104		Speed limiter	250			
8	USB socket, AUX socket, SD card slot	87	18	Manual transmission	240			
9	Storage	72		Manual transmission automated	240			
			19	Ignition switch	225			

Exterior lighting



Turn outer light switch:

- O** : off
-  : sidelights
-  : headlights
- AUTO** : automatic light control:
headlights are switched on
and off automatically.

Lighting ⇨ 109.

Automatic light control ⇨ 109.

Headlight warning device ⇨ 106.

Front fog lights ⇨ 112.

Rear fog light ⇨ 113.

Headlight flash, high beam and low beam

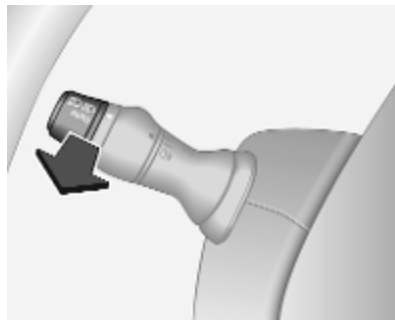

Pull lever.

High beam ⇨ 110.

Headlight flash ⇨ 111.

Turn lights

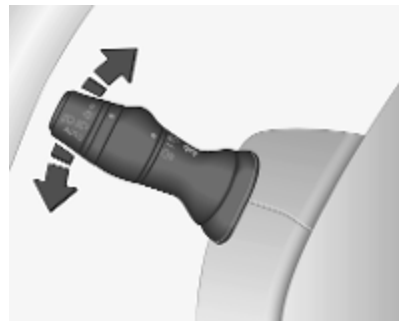

up : right turn light
down : left turn light

Turn lights ⇨ 112.

Hazard warning flashers



Operated by pressing .
Hazard warning flashers ⇨ 112.

Horn



Press .
Horn ⇨ 84.

Washer and wiper systems

Windscreen wiper

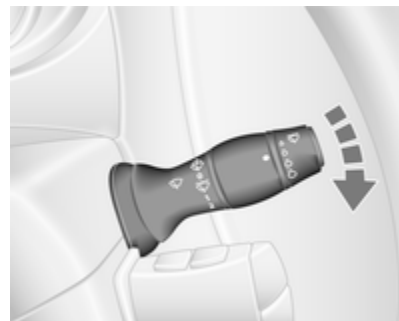

0 : off

/AUTO : timed interval wiping or
automatic wiping with
rain sensor

1 : slow

2 : fast

Windscreen wiper ⇨ 85.

Wiper blade replacement ⇨ 276.

Windscreen washer

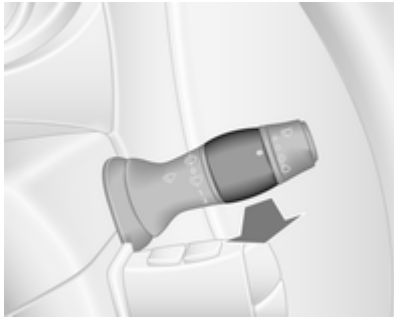

Pull lever.

short : wiper swipes once and pull washer fluid is sprayed onto the windscreen

long : wiper swipes for a few pull strokes and washer fluid is sprayed onto the windscreen

Windscreen washer ⇨ 85.

Washer fluid ⇨ 272.

Climate control

Heated rear window



Heating is operated by pressing .

Heated rear window ⇨ 42.

Heated exterior mirrors



Pressing  also activates the heated exterior mirrors.

Heated exterior mirrors ⇨ 39.

Demisting and defrosting the windows

Climate control system



- Switch cooling **A/C** on if available.
- Set temperature control to warmest level.
- Set fan speed to highest level.
- Set air distribution control to .
- Switch on heated rear window .
- Open side air vents as required and direct them towards door windows.

Climate control system ⇨ 207.

Electronic climate control system



Press .

Temperature and air distribution are set automatically and the fan runs at a high speed.

Electronic climate control system

⇨ 209.

Transmission

Manual transmission



Reverse: with the vehicle stationary, depress clutch pedal and then pull up the collar on the selector lever and engage the gear.

If the gear does not engage, set the lever to neutral, release the clutch pedal and depress again; then repeat gear selection.

Manual transmission ⇨ 240.

Manual transmission automated

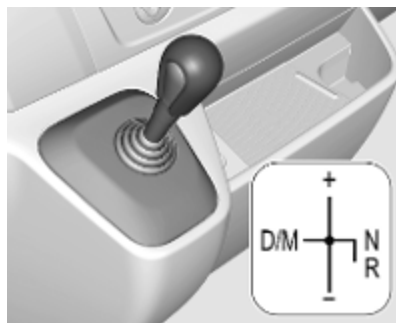

- N** : neutral
- : drive position
- +** : higher gear
- : lower gear
- D/M** : switch between automatic and manual mode
- R** : reverse gear. Engage only when vehicle is stationary.

Manual transmission automated

⇨ 240.

Starting off

Check before starting off

- Tyre pressure ⇨ 290 and condition ⇨ 315.
- Engine oil level and fluid levels ⇨ 270.
- All windows, mirrors, exterior lighting and number plates are free from dirt, snow and ice and are operational.
- Proper position of mirrors ⇨ 38, seats ⇨ 45 and seat belts ⇨ 55.
- Brake function at low speed, particularly if the brakes are wet.

Starting the engine

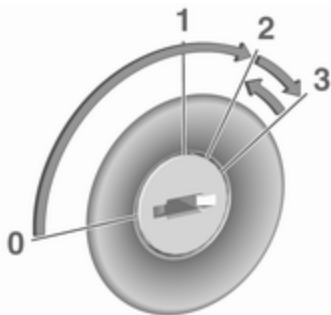

- Turn key to position **1**.
- Move the steering wheel slightly to release the steering wheel lock.
- Operate clutch and brake.
- Do not operate accelerator pedal.
- Turn the key to position **2** for preheating and wait until control indicator  extinguishes in the Driver Information Centre.
- Turn key to position **3** and release.

Starting the engine ⇨ 226.

Stop-start system

An Autostop is indicated when control indicator  illuminates in the Driver Information Centre.

Manual transmission

If the vehicle is at low speed or in standstill and certain conditions are fulfilled, activate an Autostop as follows:

- depress the clutch pedal
- move the selector lever to neutral
- release the clutch pedal

To restart the engine, with the selector lever in neutral, depress the clutch pedal.

Manual transmission automated

If the vehicle is at a standstill and certain conditions are fulfilled, activate an Autostop as follows:

- selector lever in position **N** (or **D/M**)
- depress brake pedal firmly
- do not accelerate

To restart the engine, with the selector lever in position **N** (or **D/M**) and the parking brake released, release the brake pedal.

Stop-start system ⇨ 227.

Parking

Warning

- Do not park the vehicle on an easily ignitable surface. The high temperature of the exhaust system could ignite the surface.
- Always apply parking brake without pressing release button. Apply as firmly as possible on a downhill slope or uphill slope. Depress brake pedal at the same time to reduce operating force.
- Switch off the engine.
- If the vehicle is on a level surface or uphill slope, engage first gear. On an uphill slope, turn the front wheels away from the kerb.

If the vehicle is on a downhill slope, engage reverse gear. Turn the front wheels towards the kerb.

- Close the windows.
- Remove the ignition key from the ignition switch. Turn the steering wheel until the steering wheel lock is felt to engage.

- Lock the vehicle by pressing  on the remote control ⇨ 23.
- Activate the anti-theft alarm system ⇨ 35.
- The engine cooling fans may run after the engine has been switched off ⇨ 269.

Caution

After running at high engine speeds or with high engine loads, operate the engine briefly at a low load or run in neutral for approx. 30 seconds before switching off, in order to protect the turbocharger.

Keys, locks ⇨ 19.

Laying the vehicle up for a long period of time ⇨ 268.

Keys, doors and windows

Keys, locks	19
Keys	19
Car Pass	20
Radio remote control	20
Electronic key system	21
Door locks	22
Manual door locks	23
Central locking system	23
Power door locks	28
Automatic locking	28
Child locks	29
Doors	29
Sliding door	29
Rear doors	33
Vehicle security	34
Anti-theft locking system	34
Anti-theft alarm system	35
Immobiliser	37
Exterior mirrors	38
Convex shape	38
Manual adjustment	38
Electric adjustment	38

Folding mirrors	38
Heated mirrors	39
Interior mirrors	39
Manual anti-dazzle	39
Rear view display	40
Windows	40
Windscreen	40
Manual windows	41
Power windows	41
Rear windows	41
Heated rear window	42
Sun visors	43
Roof	43
Glass panel	43

Keys, locks

Keys

Caution
Do not attach heavy or bulky items to the ignition key.

Replacement keys

The key number is specified in the Car Pass or on a detachable tag.

The key number must be quoted when ordering replacement keys as it is a component of the immobiliser system.

If the electronic key needs to be replaced, the vehicle must be taken to a workshop.

Locks ⇨ 307.

Radio remote control ⇨ 20.

Electronic key system ⇨ 21.

Central locking system ⇨ 23.

Starting the engine ⇨ 226.

Lock cylinders

Designed to free-wheel if they are forcefully rotated without the correct key or if the correct key is not fully inserted. To reset, turn cylinder with the correct key until its slot is vertical, remove key and then re-insert it. If the cylinder still free-wheels, turn the key through 180° and repeat operation.

Car Pass

The Car Pass contains security related vehicle data and should therefore be kept in a safe place.

When the vehicle is taken to a workshop, this vehicle data is needed in order to perform certain operations.

Radio remote control



Used to operate:

- central locking system
- anti-theft locking system
- anti-theft alarm system

Depending on model, the vehicle may use a 2-button or 3-button remote control.

The remote control has a range of approx. 5 m. It can be affected by external influences. The hazard warning flashers confirm operation.

Handle with care, protect it from moisture and high temperatures and avoid unnecessary operation.

Fault

If the central locking system cannot be operated with the remote control, it may be due to the following:

- The range is exceeded.
- The battery voltage is too low.
- Frequent, repeated operation of the remote control while not in range, which will require reprogramming by a workshop.
- Overload of the central locking system by operating at frequent intervals; the power supply is interrupted for a short time.
- Interference from higher-power radio waves from other sources.

Unlocking ⇨ 23.

Remote control battery replacement

Replace the battery as soon as the range reduces.



Batteries do not belong in household waste. They must be disposed of at an appropriate recycling collection point.



Remove screw and open battery compartment by inserting a coin into the slot and twisting.

Replace the battery (battery type CR2016), paying attention to the installation position.

Reattach both halves of cover ensuring it engages correctly.
Replace screw and tighten.

Electronic key system

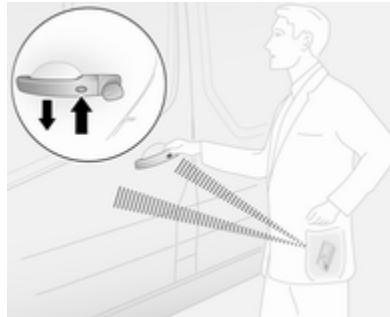

Enables a hands-free operation of the central locking system ↻ 23.

The electronic key simply needs to be on the driver's person.



Notice

Always take the electronic key with you when exiting the vehicle.

For hands-free operation, the electronic key must be outside the vehicle, within a range of approx. 1 m of the front doors or load compartment.

Hands-free operation is automatically disabled when the central locking switch  ↻ 23 is pressed. To re-enable hands-free operation, restart the engine.

Electronic key battery replacement

Replace the battery as soon as the system no longer operates properly or the range is reduced.



Batteries do not belong in household waste. They must be disposed of at an appropriate recycling collection point.



Open battery compartment by inserting a coin into the slot and twisting.

Replace the battery (battery type CR2016), paying attention to the installation position.

Notice

Do not touch the electronic circuit in the cover when replacing the battery.

Reattach both halves of cover ensuring it engages correctly.

Fault

If the central locking system cannot be operated or the engine cannot be started, the cause may be one of the following:

- fault in electronic key
- electronic key out of reception range
- battery voltage too low

- overload of the central locking system by operating at frequent intervals, the power supply is interrupted for a short time
- interference from higher-power radio waves from other sources

Door locks

Anti-theft security lock

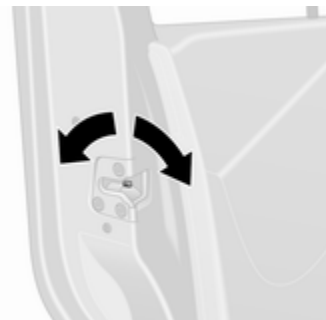

To prevent the front doors from being opened from the outside, open the door and engage the anti-theft security lock.

Using a suitable tool, turn the lock switch on the door to the horizontal locked position. The door cannot be opened from outside and can only be opened from inside the vehicle or by using the manual key.

To disengage, turn the switch to the unlocked position.

Manual door locks



To unlock the front doors manually, turn the key in the driver's door lock. Open the front doors by pulling the handles.

Sliding side door(s) ⇨ 29.

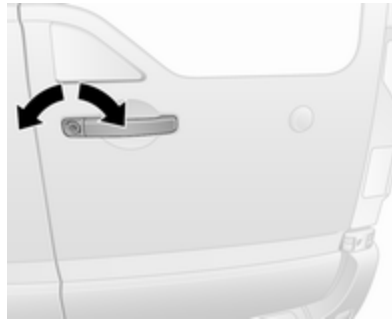

To unlock the rear doors manually, turn the key in the right-hand rear door lock. Open the door by pulling the handle.



The left-hand rear door is then released using the lever on the inside edge of the door.

Always close the left-hand door before the right-hand door.

Rear doors ⇨ 33.

Central locking system

Unlocks and locks the front doors, sliding side doors and load compartment.

With the 3-button remote control, the front doors and load compartment (and, depending on vehicle configuration, the sliding side doors) can be unlocked and locked separately.

Notice

A short time after unlocking with the remote control the doors are locked automatically if no door has been opened.

Unlocking the vehicle

Operation of central locking system with the remote control is confirmed by the hazard warning flashers. The hazard warning flashers flash once to indicate the vehicle is unlocked, and twice to indicate the vehicle is locked.

Unlocking with 2-button remote control





Press  to unlock the front doors.
Press again to unlock entire vehicle.

Unlocking with 3-button remote control





Depending on vehicle configuration:

- Press : Front doors and sliding side doors are unlocked.

Press  again: Load compartment is also unlocked.

- Press : Front doors are unlocked.

Press  again: Sliding side doors and the load compartment are also unlocked.

- Press : All doors and the load compartment are unlocked.

Locking the vehicle

Close all doors and load compartment.

When locking, if a door is open or incorrectly closed, the central locking system will lock and unlock in quick succession without flashing the hazard warning flashers.

Locking with 2-button remote control





Press : All doors and the load compartment are locked.

Locking with 3-button remote control



Press : All doors and the load compartment are locked.

Notice



Where fitted, alarm monitoring of the passenger compartment  35 is switched off by pressing and holding  (which is confirmed by an audible signal).

If this was done unintentionally, unlock the doors again and press  briefly to lock the vehicle.

Load compartment

Locking and unlocking load compartment with 2-button remote control





After unlocking the front doors with , press  again: Load compartment is unlocked.

Press  once: Load compartment is locked.

Locking and unlocking load compartment with 3-button remote control



Depending on vehicle configuration:

- Press : Load compartment is locked or unlocked.
- Press : Load compartment and sliding side doors are locked or unlocked.

Electronic key system operation



For hands-free operation, the electronic key must be outside the vehicle, within a range of approx. 1 m of the front doors or load compartment.

Notice

There is no button for hands-free operation in the exterior door handle of the sliding side door.

There must be no electronic key left inside the vehicle and no additional electronic key in the detection zones, or hands-free operation of the central locking system will not work.

Operation of central locking system with the electronic key is confirmed by the hazard warning flashers. The hazard warning flashers flash once to indicate the vehicle is unlocked, and once for 4 seconds to indicate the vehicle is locked.

When locking, if a door is open or incorrectly closed, the central locking system will lock and unlock in quick succession without flashing the hazard warning flashers.

Unlocking with electronic key - hands-free operation

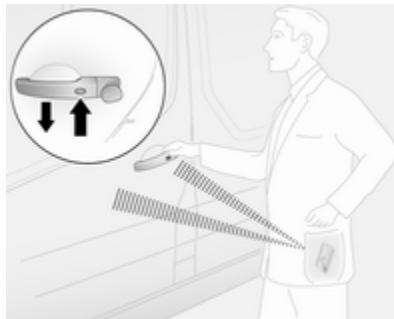

Press the button on either front door exterior handle to unlock, and pull the handle to open.

For the rear doors, press the button on the exterior handle to unlock, and pull the handle to open.

The vehicle only unlocks when at least 3 seconds have passed since locking using hands-free operation.

Locking with electronic key - hands-free operation

Press the button on any exterior door handle. All doors and the load compartment are locked.

The vehicle only locks when at least 3 seconds have passed since unlocking using hands-free operation.

Load compartment locking and unlocking with electronic key - hands-free operation

Press the button on the exterior door handle to lock or unlock the rear doors (and sliding side doors) when the electronic key is within range of the detection zone (approx. 1 m).

The rear doors (and sliding side doors) only lock / unlock when at least 3 seconds have passed since the button was last pressed.

Central locking switch

Locks or unlocks the doors and load compartment from inside the passenger compartment.



Press  to lock or unlock.

LED in switch illuminates when the vehicle is locked.

Depending on version, if the vehicle is driven with an open load compartment, the front doors (and sliding side doors) can still be locked.

With the ignition switched on, press and hold  for more than 5 seconds. When closing the rear doors, they are locked automatically.

Automatic locking when exiting the vehicle

Depending on version, the  switch can also be used to lock all doors and the load compartment automatically when closing the front door and exiting the vehicle:

Remove key from ignition switch then press and hold the  switch for more than 5 seconds. The vehicle is locked when the front door is closed.

Automatic locking after driving off
↻ 28.

Fault in remote control system

Unlocking

Manually unlock the front door by turning the key in the lock.

Switch on the ignition and press the central locking switch  to open all doors and the load compartment.

Locking

Manually lock the front door by turning the key in the lock.

Fault in central locking system

Unlocking

Manually unlock the front door by turning the key in the lock. The other doors can be opened by pulling the interior handles.

Locking

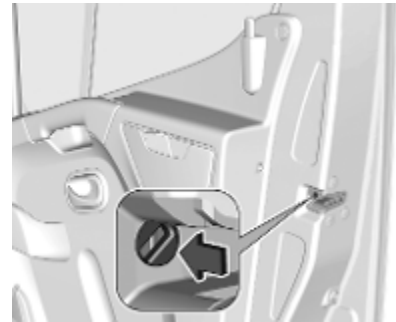

Using a key or suitable screwdriver, turn switch. The door can only be opened from inside or the front door by turning the key in the lock.

Power door locks

Combi, Bus

For safety, it is possible for the driver to operate the passenger door locks remotely.

All doors must be fully closed and automatic locking deactivated ⇨ 28.



To lock, turn the switch to . The warning light alongside the switch will flash once and an audible warning will sound.



Warning lights in the appropriate doors extinguish.

To unlock, turn the switch to . Warning lights in the appropriate doors illuminate continuously.

Fault

In the event of a fault in the system, the warning light alongside the switch illuminates continuously and an audible warning will sound.

Unlock manually the sliding door and the rear doors with interior lock switches.

If necessary, have the cause of the fault remedied by a workshop.

Automatic locking

Automatic locking after driving off

Depending on version, this security feature can be configured to automatically lock all doors and the load compartment as soon as the vehicle is driven.



Activation

With the ignition switched on, press and hold the central locking switch  for approx. 5 seconds. An audible signal confirms activation.

LED in switch illuminates when the vehicle is locked.

Deactivation

With the ignition switched on, press and hold  for approx. 5 seconds. An audible signal confirms deactivation.

Child locks

Warning

Use the child locks whenever children are occupying the rear seats.



Press down the child lock, door cannot be opened from the inside. Raise to deactivate.

Doors

Sliding door

Unlock the sliding side door with the remote control or key (if equipped). Open the door by pulling the handle and sliding the door towards the rear.

Open and close the sliding side door only when the vehicle is at a standstill with the parking brake applied (on certain models, a warning chime will sound when the sliding side door is open and the parking brake is released).



The sliding side door can be locked from inside the vehicle with the interior lock switch.

Ensure the side door is fully closed and secure before driving the vehicle.

Warning

Take care when operating the sliding side door. Risk of injury.

Ensure that nothing becomes trapped during operation and no-one is standing within the moving area.

If the vehicle is parked on a slope, open sliding doors may move accidentally on account of their weight.

Close the sliding doors before driving off.

Danger

Do not drive with the sliding side door open or ajar, e.g. when transporting bulky objects, since toxic exhaust gases, which cannot

be seen or smelled, could enter the vehicle. This can cause unconsciousness and even death.

Central locking system ⇨ 23.

Power sliding door

Opening



With vehicle at a standstill and the parking brake applied, press switch on instrument panel to open the power sliding door automatically. The LED in the switch flashes during operation.

The engine is restarted automatically when operating the power sliding door switch during an Autostop.

Stop-start system ⇨ 227.

Notice

If the parking brake is not applied when the switch is pressed, a warning chime will sound and the power sliding door will not open.

To stop movement at any time, press the switch again. Press once more to continue power sliding door movement.

Notice

If the power sliding door is locked from the inside with the child lock active, a warning chime will sound. Unlock the door manually from the inside.

Closing

Press switch again; the LED flashes and a chime sounds during operation.

In the event of opening or closing difficulties, e.g. due to frost, press and hold the switch to increase power to the sliding door.

⚠ Warning

Take care when operating the power sliding door. Risk of injury, particularly to children.

Take particular care when the vehicle is parked on a slope: open or close the door fully until it latches into its locking position.

Keep a close watch on the moving door when operating. Ensure that nothing becomes trapped during operation and no-one is standing within the moving area.

Notice

Do not operate power sliding door too often without engine running as this will discharge the vehicle battery.

Emergency exit

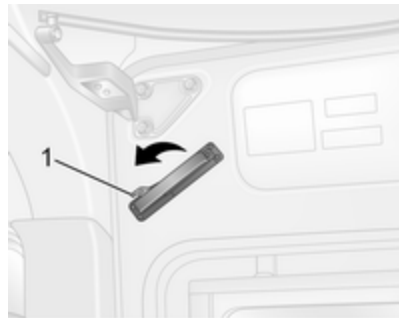

In an emergency, the sliding side door can be opened manually after releasing the interior handle.

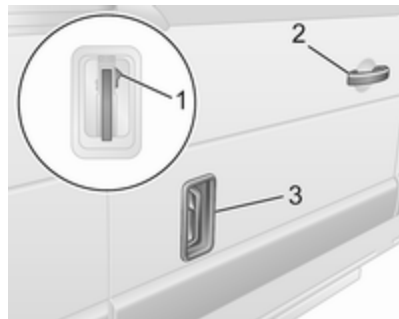

Alternatively, if the vehicle is unlocked, open the door using the exterior handle (depending on model variant). Lift the handle (3) to the second notch position, then slide the door backwards using the handle (2) near the front edge of the door.

Reset

If the door has been opened manually, the power sliding door system must be reset.



Open the sliding side door halfway and move the relevant handle to the first notch position. The warning light

illuminates in the instrument panel. Then press the button (1) on the relevant handle.

Move the handle back and forth to ensure the door actuator motor operates, then press and hold the switch on the instrument panel to fully close the door. The warning light extinguishes when the system is reset correctly.

Maintenance



The counter is incremented at each opening and closing to determine the replacement of the drive belt. Seek the assistance of a workshop.

If the drive belt should fail, the door may still be opened and closed manually.

Fault

If a system fault is detected when unlocking the doors, an audible warning will sound and the LED in the switch illuminates. Check position of exterior handle. Reset handle if in the open position and use key to operate door locks.

Seek the assistance of a workshop if the fault remains.

Power side step

Warning

Take care when using the power side step, particularly in wet and cold weather conditions.

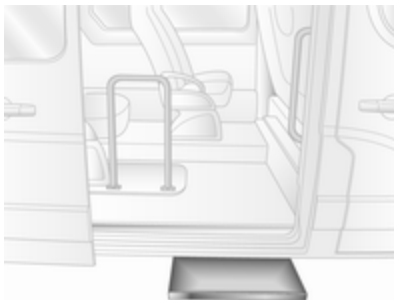

The power side step operates automatically when the sliding door is opened or closed.

Warning

Ensure there is adequate clearance to allow the power side step to fully extend and retract without obstruction.



The indicator illuminates during operation of the power side step. If it remains illuminated with the door closed, the step has not retracted, or the door has not fully latched into its locking position.

In the event of a failure, manually retract the power side step by unscrewing the orange handwheel located at the rear of the step, ensuring that there are no obstacles preventing closure. When the step is retracted, screw in the orange handwheel. Seek the assistance of a workshop.

Rear doors

Lock and unlock the rear doors with the remote control or key (if equipped).

Central locking system ⇨ 23.

Manual door locks ⇨ 23.

To open the right-hand rear door, pull the exterior handle.



The right-hand door can also be opened from inside the vehicle by pulling the interior handle.



The left-hand rear door is then released using the lever.

Warning

The rear lights may be obscured if the rear doors are open and the vehicle is parked on the roadside.

Make other road users aware of the vehicle, by using a warning triangle or other equipment specified in the road traffic regulations.

The doors are retained in the 90° position by locking stays.



To open the doors to 180° or further (depending on model) release locking stays from the catches on the door frames and lock in place. Swing doors open to the desired position.



When opening the doors to 270°, the doors are retained in the fully open position by magnets on the body side.

⚠ Warning

Ensure extended opening doors are secured when fully opened.

Opened doors may slam due to the force of the wind!

When closing the doors, secure each locking stay to the catch on the door frame.

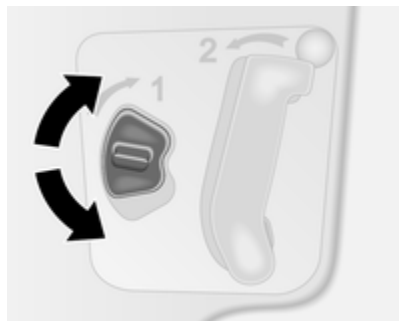

The rear doors can be locked from inside the vehicle with the interior lock switch on the inside of the right-hand door.

Always close the left-hand door before the right-hand door.

Combi, Bus

In left-hand drive vehicles, the rear doors are opened from inside the vehicle by pulling the interior handle.

In right-hand drive vehicles, from inside the vehicle pull the interior handle on the right-hand door and open, then release the left-hand door by lowering the lever and open.

Always close the left-hand door before the right-hand door.

⚠ Danger

Do not drive with the rear doors open or ajar, e.g. when transporting bulky objects, since toxic exhaust gases, which cannot be seen or smelled, could enter the vehicle. This can cause unconsciousness and even death.

Vehicle security

Anti-theft locking system

⚠ Warning

Do not use the system if there are people in the vehicle! The doors cannot be unlocked from the inside.

The system deadlocks the doors. All doors must be closed or the system cannot be activated.

Notice

The anti-theft locking system cannot be activated when the hazard warning lights or sidelights are switched on.

Activation and deactivation are not possible with the central locking switch.

2-button and 3-button remote control operation

Activation



Press  twice within 3 seconds.

Hazard warning lights flash five times as confirmation.

Deactivation

Unlock the doors by pressing  on the remote control.

Electronic key system operation

Operation is confirmed by the hazard warning flashers.

Activation

For hands-free operation, the electronic key must be outside the vehicle, within a range of approx. 1 m of the front doors or load compartment.

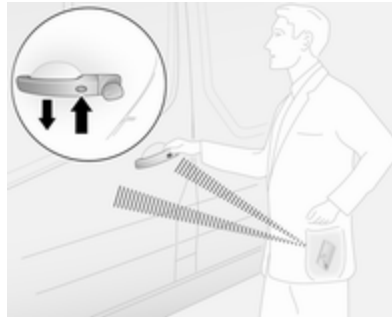

Press the button twice on any exterior door handle.

Deactivation

Unlock the doors by pressing the button on any exterior door handle.

Hands-free operation is automatically disabled when the central locking switch  is pressed. To re-enable hands-free operation, restart the engine.

Central locking system ⇨ 23.

Electronic key system ⇨ 21.

Anti-theft alarm system

The anti-theft alarm system is operated in conjunction with the central locking system.

It monitors:

- doors, bonnet
- passenger compartment
- load compartment
- ignition
- interruption of alarm siren power supply

Activation

All doors and the bonnet must be closed.



Press  to activate anti-theft alarm system. Hazard warning lights flash twice to confirm activation.

If the hazard warning lights do not flash upon activation, a door or the bonnet is not fully closed.

Notice

Changes to the vehicle interior, e.g. the use of seat covers, and open windows, could impair the function of passenger compartment monitoring.

Electronic key

For hands-free operation, the electronic key must be outside the vehicle, within a range of approx. 1 m of the front doors or load compartment.

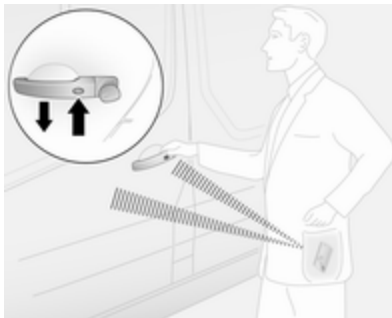

Press the button on any exterior door handle.

Electronic key system ⇨ 21.

Deactivation

Unlocking the vehicle or switching on the ignition deactivates the anti-theft alarm system. Hazard warning lights flash once to confirm deactivation.

Notice

If the alarm has been triggered, unlocking the vehicle with the key will not stop the alarm siren. To stop the siren, switch on the ignition. The hazard warning lights will not flash upon deactivation if the alarm has been triggered.

Activation without monitoring of passenger compartment

Switch off monitoring of the passenger compartment when people or animals are being left in the vehicle, or if the auxiliary heater ⇨ 215 is set for a timed or remote controlled start.



Depending on vehicle configuration:

- press and hold , or
- switch ignition on and off twice quickly, then close doors and activate the anti-theft alarm system

An audible signal will sound as confirmation.

The status will remain until the doors are unlocked.

Alarm

When triggered, the alarm sounds via a separate battery-backed power sounder, and the hazard warning lights flash simultaneously. The number and duration of alarm signals are stipulated by legislation.

If the vehicle battery is disconnected or its power supply is interrupted, the alarm siren will be triggered. First deactivate the anti-theft alarm system if the vehicle battery must be disconnected.

To silence the alarm siren (if triggered) and therefore deactivate the anti-theft alarm system, reconnect

vehicle battery and unlock vehicle with remote control button  (or switch on the ignition).

Immobiliser

The system is part of the ignition switch and checks whether the vehicle is allowed to be started with the key being used.



The immobiliser is activated automatically after the key has been removed from the ignition switch and also if the key is left in the ignition switch when the engine is turned off.

If the engine cannot be started, switch off the ignition and remove key, wait approx. 2 seconds and then repeat the start attempt. If start attempt is unsuccessful, attempt to start the engine using the spare key and seek the assistance of a workshop.

Notice

Radio Frequency Identification (RFID) tags may cause interference with the key. Do not have it placed near the key when starting the vehicle.

Notice

The immobiliser does not lock the doors. Always lock the vehicle after leaving it  23 and switch on the anti-theft alarm system  35.

Exterior mirrors

Convex shape

The convex exterior mirror contains an aspherical area and reduces blind spots. The shape of the mirror makes objects appear smaller, which will affect the ability to estimate distances.

Manual adjustment

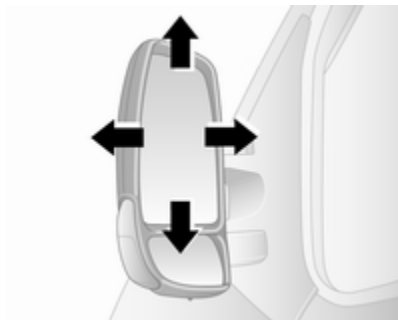

Adjust mirrors by swivelling in required direction.

The lower mirrors are not adjustable.

Electric adjustment



Switch on ignition to operate electric exterior mirrors.

Select the relevant exterior mirror and swivel the control to adjust the mirror.

No mirror is selected when the control is in the centre position.

The lower mirrors are not adjustable.

Folding mirrors



For pedestrian safety, the exterior mirrors will swing out of their normal mounting position if they are struck with sufficient force. Reposition the mirror by applying slight pressure to the mirror housing.

Parking position

The exterior mirrors can be folded in by pressing gently on the outer edge of the housing, e.g. when in a confined parking situation.

Heated mirrors



Operated by pressing  on either system. LED illuminates in button during operation.



Heating works with the engine running and is switched off automatically after a short time.

Climate control system ⇨ 207.

Electronic climate control system ⇨ 209.

Interior mirrors

Manual anti-dazzle



To reduce dazzle, adjust the lever on the underside of the mirror housing.

Wide view mirror

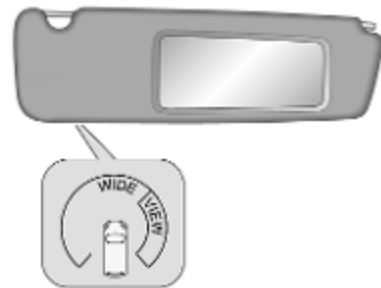

Depending on vehicle, a large convex mirror is located in the front passenger sun visor which helps to increase visibility and reduce blind spots.

Rear view display



The rear view display shows the standard rear view provided by a camera mounted on top of the rear end.

The mounting position and view angle of the camera cause a blind spot area behind the vehicle. While reverse gear is engaged, the rear view display is switched off.

Adjustment

Press  to adjust:

- brightness by using 
- contrast by using + or -

- colour by using + or -
- reset to restore the factory settings

Fault

The rear view display may not operate properly when:

- the surrounding is dark
- the sun or the beam of headlights is shining directly into the camera lens
- ice, snow, mud, or anything else covers the camera lens. Clean the lens, rinse it with water, and wipe it with a soft cloth
- there are extreme temperature changes

Rear view camera ↪ 258.

Windows

Windscreen

Windscreen stickers

Do not attach stickers, e.g. toll road stickers or similar, on the windscreen in the area of the interior mirror. Otherwise the detection zone of the sensor in the mirror housing could be restricted.

Windscreen replacement

Caution

If the vehicle has a front-looking camera sensor for the driver assistance systems, it is very important that any windscreen replacement is performed accurately according to Vauxhall specifications. Otherwise, these systems may not work properly and there is a risk of unexpected behaviour and / or messages from these systems.

Manual windows

The door windows can be opened or closed with the window cranks.

Power windows

⚠ Warning

Take care when operating the power windows. Risk of injury, particularly to children.

Keep a close watch on the windows when closing them. Ensure that nothing becomes trapped in them as they move.

Switch on ignition to operate power windows.



Operate the switch for the respective window by pushing to open or pulling to close.

For vehicles with automatic opening feature for the driver's door window: When opening, operate the switch again to stop window movement.

In the event of closing difficulties due to frost or the like, operate the switch several times to close the window in stages.

Overload

If the windows are repeatedly operated within short intervals, the window operation is disabled for some time.

Rear windows

Sliding side windows



Press catch and slide window to open. Ensure catch engages when closing.

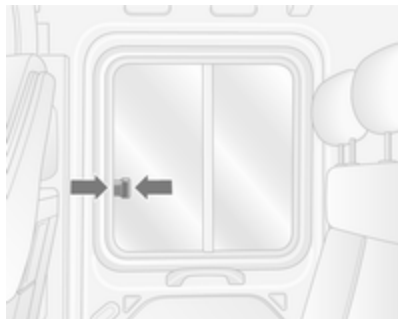

Press catch and slide window to open. Ensure catch engages when closing.

Opening side windows

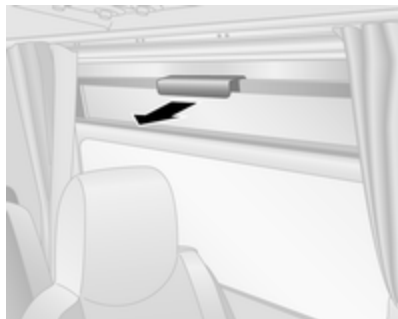

Pull handle to open window.

Notice

Depending on vehicle, some windows may not open fully.

Emergency exit



To provide an emergency exit from the vehicle, use hammer 1 to strike glass 2.

Depending on version, emergency exit may be via the roof glass panel
 ⇨ 43.

Rear reversing lens



A rear reversing lens may be fitted to the rear window.

The rear reversing lens assists the driver when reversing by reducing blind spots.

Heated rear window



Operated by pressing  on either system. LED illuminates in button during operation.



Heating works with the engine running and is switched off automatically after a short time.

Climate control system ⇨ 207.

Electronic climate control system ⇨ 209.

Sun visors

The sun visors can be folded down or swivelled to the side to prevent dazzling.

If the sun visors have integral mirrors, the mirror covers should be closed when driving.

Sun visors may also feature a holder for parking tickets etc.

Wide view mirror ⇨ 39.

Roof

Glass panel



Depending on model variant, the load compartment may incorporate a single or a double glass roof panel.

Emergency exit



In an emergency, the glass can be broken. Use the hammer provided to strike the glass panel.

Depending on version, emergency exit may alternatively be via the side windows ⇨ 41.

Seats, restraints

Head restraints	44
Front seats	45
Seat position	45
Seat adjustment	46
Armrest	50
Heating	51
Rear seats	51
Seat belts	54
Three-point seat belt	55
Airbag system	58
Front airbag system	61
Side airbag system	62
Airbag deactivation	62
Child restraints	64
Child restraint systems	64
Child restraint installation locations	66

Head restraints

Position

⚠ Warning

Only drive with the head restraint set to the proper position.

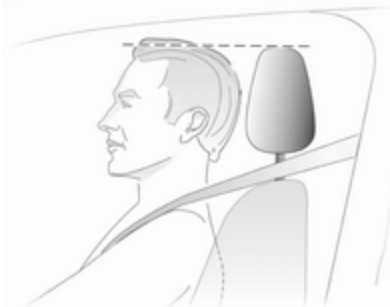

The upper edge of the head restraint should be at upper head level. If this is not possible for extremely tall people, set to highest position, and set to lowest position for small people.

Adjustment

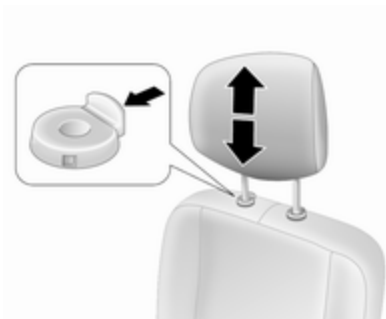

Pull up to raise or press button and lower head restraint. Ensure the head restraint engages.



Depending on version, head restraints can also be tilted forwards or backwards. Push or pull the lower part of the head restraint to adjust.

Notice

Approved accessories may only be attached to the front passenger seat head restraint if the seat is not in use.

Removal

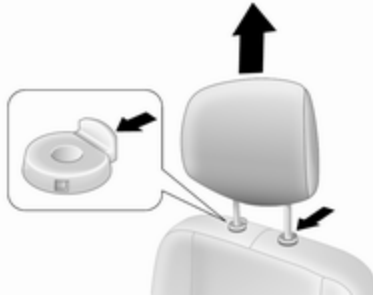

E.g. when using a child restraint system ⇨ 64.

First tilt the backrest forwards, then pull up head restraint to uppermost position. Press both release buttons and pull the head restraint upwards to remove.

Stow head restraints securely in load compartment.

Do not drive with head restraints removed if the seat is occupied.

Installation

First tilt the backrest forwards, then insert the rods of the head restraint into their holes.

Lower head restraint as far as possible, then raise head restraint (press both release buttons first, if necessary) until it engages securely in desired position.

Front seats

Seat position

⚠ Warning

Only drive with the seat correctly adjusted.

⚠ Danger

Do not sit closer than 25 cm to the steering wheel, to permit safe airbag deployment.

⚠ Warning

Never adjust seats while driving as they could move uncontrollably.

⚠ Warning

Never store any loose objects under the seats.

Underseat storage, storage box ⇨ 74.



- Sit with buttocks as far back against the backrest as possible. Adjust the distance between the seat and the pedals so that legs are slightly angled when pressing the pedals. Slide the front passenger seat as far back as possible.
- Set seat height high enough to have a clear field of vision on all sides and of all display instruments. There should be at least one hand of clearance between head and the roof frame. Thighs should rest lightly on the seat without pressing into it.

- Sit with shoulders as far back against the backrest as possible. Set the backrest rake so that it is possible to reach the steering wheel with arms slightly bent. Maintain contact between shoulders and the backrest when turning the steering wheel. Do not angle the backrest too far back. We recommend a maximum rake of approx. 25°.
- Adjust seat and steering wheel in a way that the wrist rests on top of the steering wheel while the arm is fully extended and shoulders on the backrest.
- Adjust the steering wheel ↻ 84.
- Adjust the head restraint ↻ 44.
- Adjust the height of the seat belt ↻ 55.
- Adjust the lumbar support so that it supports the natural shape of the spine ↻ 46.

Seat adjustment

Drive only with engaged seats and backrests.

Longitudinal adjustment



Pull handle, slide seat, release handle.

Try to move the seat back and forth to ensure that the seat is locked in place.

Suspension seat longitudinal adjustment



Pull handle, slide seat, release handle.

Try to move the seat back and forth to ensure that the seat is locked in place.

Backrest inclination

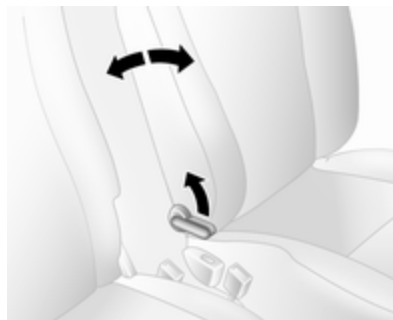

Pull lever, adjust inclination and release lever. Allow the seat to engage audibly.

Suspension seat backrest inclination



Pull lever, adjust inclination and release lever. Allow the seat to engage audibly.

Seat height



Lever pumping motion

up : seat higher
down : seat lower

Suspension seat height

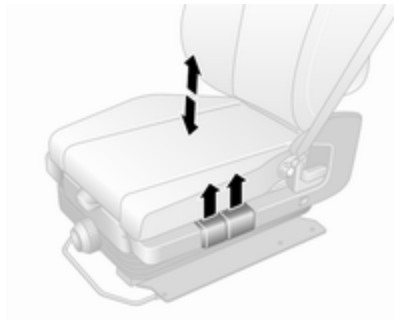

Pull up front release lever up to adjust height of front part of seat.

Pull up rear release lever to adjust height of rear part of seat.

Lumbar support



Adjust lumbar support to suit personal requirements.

Increasing and decreasing support: turn the handwheel while relieving the load on the backrest.

Suspension seat lumbar support



Adjust lumbar support to suit personal requirements.

Operate hand pump repeatedly (located on underside of unit) to increase firmness.

Press release button (located at front of unit) to decrease firmness.

Suspension seat sensitivity

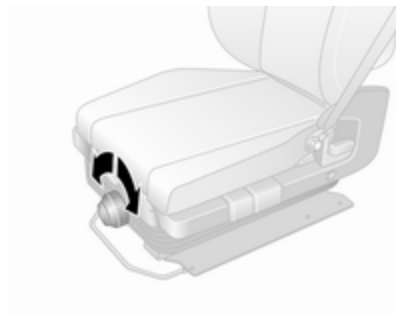

Rotate knob to adjust the sensitivity of the suspension seat.

turn right : more stiff

turn left : less stiff

Swivel seat adjustment

Seat positioning

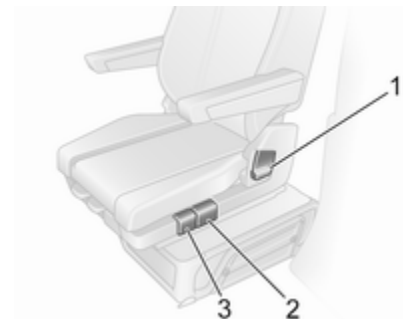

Move handle 2, slide seat, release handle.

Try to move the seat back and forth to ensure that the seat is locked in place.

Seat backrests

Pull lever 1, adjust inclination and release lever. Allow the seat to engage audibly.

Seat base angle

Move handle 3 to adjust angle of seat base.

Lumbar support

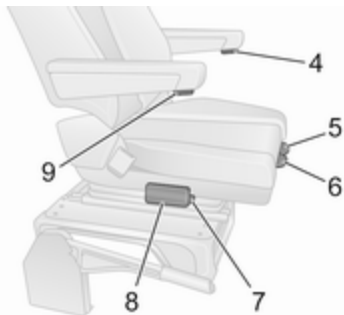

Adjust lumbar support to suit personal requirements.

Operate hand pump **8** repeatedly (located on underside of unit) to increase firmness.

Press release button **7** to decrease firmness.

Seat base positioning

Lift handle **5**, move seat base backwards or forwards, release handle.

Armrests

To adjust the height of the armrests, turn control knob **4** or **9**.

Swivelling the seat

The driver's seat can be swivelled up to 180° from the forward-facing position, e.g. for easier access to the load compartment area when the vehicle is stationary and the engine is switched off.

Before swivelling the seat, make the following preparations:

- Unfasten seat belt.
- Fold up the armrests.
- Slide seat as far back as possible.
- Set seat base angle to its lowest position.
- Adjust backrest inclination to vertical position.
- Open the driver's door.

Lift handle **6**, swivel seat from the forward-facing position, release handle.

Always return the seat to the forward-facing position before driving and ensure the seat is locked in place before starting off.

Armrest



Armrests can be folded up when not required.

Heating

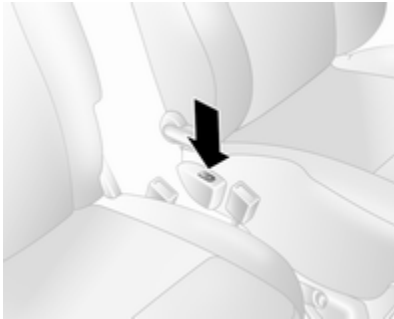

Press  for the respective seat; LED in switch illuminates. Press other end of rocker switch to turn seat heating off.

Vehicles with suspension seat: switch  is located below the backrest release lever on the outboard side of the seat.

Seat heating is thermostatically controlled and switches off automatically when seat temperature is sufficient. LED also illuminates when the system is on, not just when heating is active.

Prolonged use for people with sensitive skin is not recommended. Seat heating is operational when the engine is running.

Rear seats

Rear seat access



To facilitate access to the 3rd row seats (where fitted), open sliding side door and pull release lever on folding access seat in the 2nd row and fold the seat backrest forwards. If necessary, unfasten seat belts from their buckles.

⚠ Warning

Ensure that the backrest returns to its correct position and the seat belt buckles are fastened securely.

Fastening and unfastening seat belt ⇨ 55.

Sliding door ⇨ 29.

Removable rear seats**⚠ Warning**

When rear seats are being removed, keep hands and feet away from the moving area.

Never remove seats while driving as they could move uncontrollably.

Ensure that the rear seats and backrests are fully engaged before occupying the rear seats.

Removal

On some variants, the load compartment area can be increased by removing the rear seats.

⚠ Warning

Removable rear seats are heavy!
Do not attempt to remove without assistance.

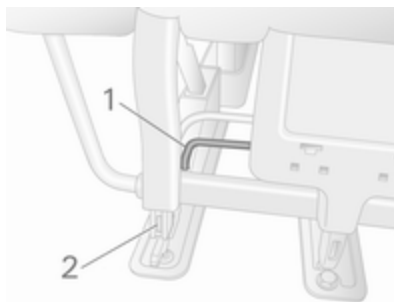

- Pull up lever **1** on both sides of the seat. The pins **2** visibly protrude to indicate that the seat is unlocked.
- Move the seat towards the rear to release from the floor anchor points.
- Lift seat to remove.

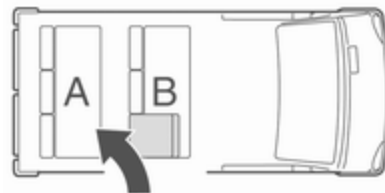
Installation

When re-installing seats, always ensure that the row with the folding access seat **B** is positioned correctly in front of the fixed seat row **A**.

Caution

The 2nd and 3rd row seats are not interchangeable and must be fitted back into their original position.

Notice

Make sure that the anchor points are clean before installing the seat. They should be free from grit or any other item which may prevent the seat from locking securely.

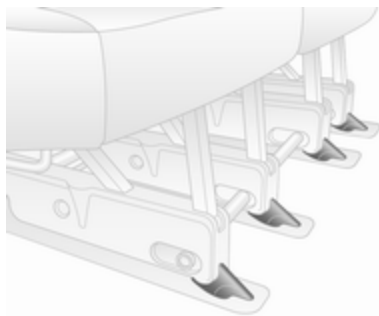

Position the seat guides immediately behind the front floor anchor points, and slide forwards to engage.

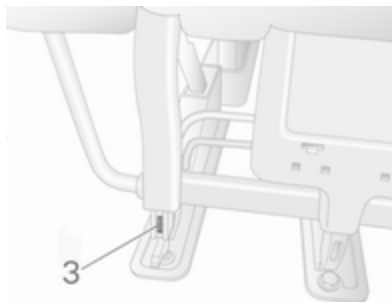

The seat locks automatically and the pins **3** will no longer be visible, to indicate that the seat is locked.

Caution

When installing the rear seats, ensure they are properly located on the floor anchor points and that the locking catches are fully engaged.

Consult a workshop if the seats cannot be locked securely in position.

Bus**Removal****⚠ Warning**

Removable rear seats are heavy!
Do not attempt to remove without assistance.

Using the tool from the tool kit located in the glovebox, turn levers to unlock the seat:

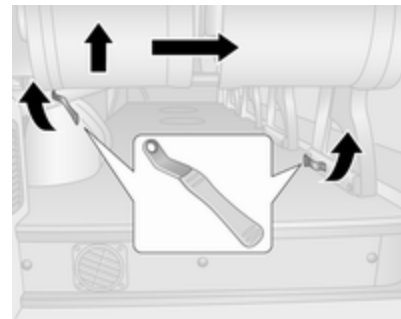

1. Release the outboard fixing.
2. Release the inboard fixing (located at the base of the seat).

- Lift the seat from the rear.
- Pull the seat towards the centre of the vehicle to release the seat completely from its anchor points.

Installation

Notice

Make sure that the anchor points are clean before installing the seat. They should be free from grit or any other item which may prevent the seat from locking securely.

- Position the seat over the anchor points.
- Lower the seat until it audibly engages in the anchor points.
- Ensure the seat is locked securely in position by trying to move the seat back and forth and from left to right.

Repeat installation procedure if necessary.

Consult a workshop if the seat cannot be locked securely in position.

Seat belts



The seat belts are locked during heavy acceleration or deceleration of the vehicle, holding the occupants in the sitting position. Therefore, the risk of injury is considerably reduced.

⚠ Warning

Fasten seat belt before each trip.
In the event of an accident, people not wearing seat belts endanger their fellow occupants and themselves.

Seat belts are designed to be used by only one person at a time.

Child restraint system ⇨ 64.

Periodically check all parts of the belt system for damage and proper functionality.

Have damaged components replaced. After an accident, have the belts and triggered belt pretensioners replaced by a workshop.

Notice

Make sure that the belts are not damaged by shoes or sharp-edged objects or are trapped. Prevent dirt from getting into the belt retractors.

Seat belt reminder

Depending on version, both front seats may be equipped with a seat belt reminder, indicated by control indicator  in the instrument panel ⇨ 94, ⇨ 97.

Belt force limiters



On the front seats, stress on the body is reduced by the gradual release of the belt during a collision.

Belt pretensioners

In the event of a head-on or rear-end collision of a certain severity, the front seat belts are tightened.

⚠ Warning

Incorrect handling (e.g. removal or fitting of belts) can trigger the belt pretensioners.

Deployment of the belt pretensioners is indicated by continuous illumination of control indicator   97.

Triggered belt pretensioners must be replaced by a workshop. Belt pretensioners can only be triggered once.

Notice

Do not affix or install accessories or other objects that may interfere with the operation of the belt pretensioners. Do not make any modifications to belt pretensioner components as this will invalidate the vehicle operating permit.

Three-point seat belt

Seat belts on the front seats

Fasten



Withdraw the belt from the retractor, guide it untwisted across the body and insert the latch plate into the buckle.

Tighten the lap belt regularly whilst driving by pulling the shoulder belt.

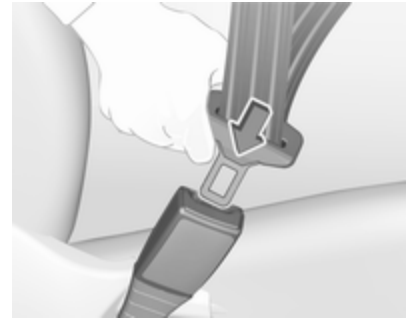

Loose or bulky clothing prevents the belt from fitting snugly. Do not place objects such as handbags or mobile phones between the belt and your body.

⚠ Warning

The belt must not rest against hard or fragile objects in the pockets of your clothing.

Seat belt reminder   97.

Height adjustment

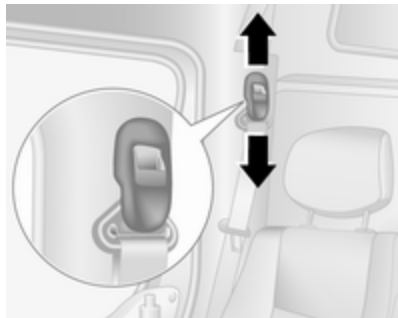

1. Pull belt out slightly.
2. Shift the height adjustment upwards or press button to disengage and push the height adjustment downwards.



Adjust the height so that the belt lies across the shoulder. It must not lie across the throat or upper arm.

⚠ Warning

Do not adjust while driving.

Unfasten



To unfasten belt, press red button on belt buckle. The seat belt retracts automatically.

Seat belts on the rear seats

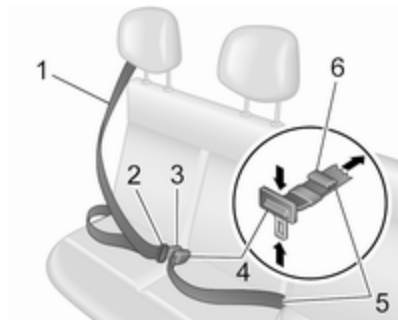

Withdraw belt **1** from the retractor, guide it untwisted across the body and ensure that latch plate **2** is fully engaged in its buckle **3** by pulling on the latch plate **2**.

The lap belt **5** must be worn closely over the thighs and against the pelvis.

To tighten, pull on free section **6** of the belt. To loosen, turn adjusting buckle **4** until it is at 90° to the belt and press the adjusting buckle **4** while pulling lap belt **5**.

Loose or bulky clothing prevents the belt from fitting snugly. Do not place objects such as handbags or mobile phones between the belt and your body.

⚠ Warning

The belt must not rest against hard or fragile objects in the pockets of your clothing.

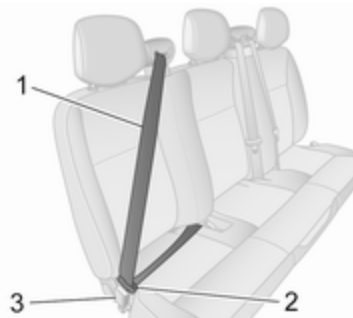

To unfasten, press red button on belt buckle **3** to release the latch plate **2**.

Guide the seat belt **1** as it retracts automatically.

⚠ Warning

Ensure that the rear seats and backrests are fully engaged before occupying the rear seats.

Rear seats ⇨ 51.

Caution

To avoid damage to the vehicle, always fasten the rear seat belts even if the seats are not occupied.

Using the seat belt while pregnant



⚠ Warning

The lap belt must be positioned as low as possible across the pelvis to prevent pressure on the abdomen.

Airbag system

The airbag system consists of a number of individual systems depending on the scope of equipment.

When triggered the airbags inflate within milliseconds. They also deflate so quickly that it is often unnoticeable during the collision.

⚠ Warning

As the airbag system deploys in an explosive manner, repairs must be performed by skilled personnel only.

⚠ Warning

Adding accessories that change the vehicle's frame, bumper system, height, front end or side sheet metal, may keep the airbag system from working properly. The operation of the airbag system can also be affected by changing any parts of the front seats, seat belts,

airbag sensing and diagnostic module, steering wheel, instrument panel, inner door seals including the speakers, any of the airbag modules, ceiling or pillar trim, front sensors, side impact sensors or airbag wiring.

Notice

The airbag systems and belt pretensioner control electronics are located in the centre console area. Do not put any magnetic objects in this area.

Do not affix any objects onto the airbag covers and do not cover them with other materials. Have damaged covers replaced by a workshop.

Each airbag is triggered only once. Have deployed airbags replaced by a workshop. Furthermore, it may be necessary to have the steering wheel, the instrument panel, parts of the panelling, the door seals, handles and the seats replaced.

Do not make any modifications to the airbag system as this will invalidate the vehicle operating permit.

Control indicator  for airbag systems
 ⇨ 97.

Child restraint systems on front passenger seat with airbag systems

Warning according to ECE R94.02:



EN: NEVER use a rear-facing child restraint system on a seat protected by an ACTIVE AIRBAG in front of it, DEATH or SERIOUS INJURY to the CHILD can occur.

DE: Nach hinten gerichtete Kindersitze NIEMALS auf einem Sitz verwenden, der durch einen davor befindlichen AKTIVEN AIRBAG geschützt ist, da dies den TOD oder SCHWERE VERLETZUNGEN DES KINDES zur Folge haben kann.

FR: NE JAMAIS utiliser un siège d'enfant orienté vers l'arrière sur un siège protégé par un COUSSIN GONFLABLE ACTIF placé devant lui, sous peine d'infliger des BLESSURES GRAVES, voire MORTELLES à l'ENFANT.

ES: NUNCA utilice un sistema de retención infantil orientado hacia atrás en un asiento protegido por un AIRBAG FRONTAL ACTIVO. Peligro de MUERTE o LESIONES GRAVES para el NIÑO.

RU: ЗАПРЕЩАЕТСЯ устанавливать детское удерживающее устройство лицом назад на сиденье автомобиля, оборудованном фронтальной подушкой безопасности, если ПОДУШКА НЕ ОТКЛЮЧЕНА! Это

может привести к СМЕРТИ или СЕРЬЕЗНЫМ ТРАВМАМ РЕБЕНКА.

NL: Gebruik NOOIT een achterwaarts gericht kinderzitje op een stoel met een ACTIEVE AIRBAG ervoor, om DODELIJK of ERNSTIG LETSEL van het KIND te voorkomen.

DA: Brug ALDRIG en bagudvendt autostol på et forsæde med AKTIV AIRBAG, BARNET kan komme I LIVSFARE eller komme ALVORLIGT TIL SKADE.

SV: Använd ALDRIG en bakåtvänd barnstol på ett säte som skyddas med en framförvarande AKTIV AIRBAG. DÖDSFALL eller ALLVARLIGA SKADOR kan drabba BARNET.

FI: ÄLÄ KOSKAAN sijoita taaksepäin suunnattua lasten turvaistuinta istuimelle, jonka edessä on AKTIIVINEN TURVATYYNY, LAPSI VOI KUOLLA tai VAMMAUTUA VAKAVASTI.

NO: Bakovervendt barnesikringsutstyr må ALDRI brukes på et sete med AKTIV KOLLISJONSPUTE foran, da det kan

føre til at BARNET utsettes for LIVSFARE og fare for ALVORLIGE SKADER.

PT: NUNCA use um sistema de retenção para crianças voltado para trás num banco protegido com um AIRBAG ACTIVO na frente do mesmo, poderá ocorrer a PERDA DE VIDA ou FERIMENTOS GRAVES na CRIANÇA.

IT: Non usare mai un sistema di sicurezza per bambini rivolto all'indietro su un sedile protetto da AIRBAG ATTIVO di fronte ad esso: pericolo di MORTE o LESIONI GRAVI per il BAMBINO!

EL: ΠΟΤΕ μη χρησιμοποιείτε παιδικό κάθισμα ασφαλείας με φορά προς τα πίσω σε κάθισμα που προστατεύεται από μετωπικό ΕΝΕΡΓΟ ΑΕΡΟΣΑΚΟ, διότι το παιδί μπορεί να υποστεί ΘΑΝΑΣΙΜΟ ή ΣΟΒΑΡΟ ΤΡΑΥΜΑΤΙΣΜΟ.

PL: NIE WOLNO montować fotelika dziecięcego zwróconego tyłem do kierunku jazdy na fotelu, przed którym znajduje się WŁĄCZONA PODUSZKA POWIETRZNA. Niezastosowanie się do tego

zalecenia może być przyczyną ŚMIERCI lub POWAŻNYCH OBRAŻEŃ u DZIECKA.

TR: Arkaya bakan bir çocuk emniyet sistemini KESİNLİKLE önünde bir AKTİF HAVA YASTIĞI ile korunmakta olan bir koltukta kullanmayınız. ÇOCUK ÖLEBİLİR veya AĞIR ŞEKİLDE YARALANABİLİR.

UK: НИКОЛИ не використовуйте систему безпеки для дітей, що встановлюється обличчям назад, на сидінні з УВІМКНЕНОЮ ПОДУШКОЮ БЕЗПЕКИ, інакше це може призвести до СМЕРТІ чи СЕРІОЗНОГО ТРАВМУВАННЯ ДИТИНИ.

HU: SOHA ne használjon hátrafelé néző biztonsági gyerekülést előlről AKTÍV LÉGZSÁKKAL védett ülésen, mert a GYERMEK HALÁLÁT vagy KOMOLY SÉRÜLÉSÉT okozhatja.

HR: NIKADA nemojte koristiti sustav zadržavanja za djecu okrenut prema natrag na sjedalu s AKTIVNIM ZRAČNIM JASTUKOM ispred njega, to bi moglo dovesti do SMRTI ili OZBILJNJIH OZLJEDA za DIJETE.

SL: NIKOLI ne nameščajte otroškega varnostnega sedeža, obrnjenega v nasprotni smeri vožnje, na sedež z AKTIVNO ČELNO ZRAČNO BLAZINO, saj pri tem obstaja nevarnost RESNIH ali SMRTNIH POŠKODB za OTROKA.

SR: NIKADA ne koristiti bezbednosni sistem za decu u kome su deca okrenuta unazad na sedištu sa AKTIVNIM VAZDUŠNIM JASTUKOM ispred sedišta zato što DETE može da NASTRADA ili da se TEŠKO POVREDI.

MK: НИКОГАШ не користете детско седиште свртено наназад на седиште заштитено со АКТИВНО ВОЗДУШНО ПЕРНИЧЕ пред него, затоа што детето може ДА ЗАГИНЕ или да биде ТЕШКО ПОВРЕДЕНО.

BG: НИКОГА не използвайте детска седалка, гледаща назад, върху седалка, която е защитена чрез АКТИВНА ВЪЗДУШНА ВЪЗГЛАВНИЦА пред нея - може да се стигне до СМЪРТ или СЕРИОЗНО НАРАНЯВАНЕ на ДЕТЕТО.

RO: Nu utilizați NICIODATĂ un scaun pentru copil îndreptat spre partea din spate a mașinii pe un scaun protejat de un AIRBAG ACTIV în fața sa; acest lucru poate duce la DECESUL sau VĂTĂMAREA GRAVĂ a COPILULUI.

CS: NIKDY nepoužívejte dětský zádržný systém instalovaný proti směru jízdy na sedadle, které je chráněno před sedadlem AKTIVNÍM AIRBAGEM. Mohlo by dojít k VÁŽNĚMU PORANĚNÍ nebo ÚMRTÍ DÍTĚTE.

SK: NIKDY nepoužívajte detskú sedačku otočenú vzad na sedadle chránenom AKTÍVNÝM AIRBAGOM, pretože môže dôjsť k SMRTI alebo VÁŽNYM ZRANENIAM DIEŤAŤA.

LT: JOKIU BŪDU nemontuokite atgal atgretos vaiko tvirtinimo sistemas sėdynėje, prieš kurią įrengta AKTYVI ORO PAGALVĖ, nes VAIKAS GALI ŽŪTI arba RIMTAI SUSIŽALOTI.

LV: NEKĀDĀ GADĪJUMĀ neizmantojiet uz aizmuguri vērstu bērnu sēdekļi sēdvietā, kas tiek aizsargāta ar tās priekšā uzstādītu

AKTĪVU DROŠĪBAS SPILVENU, jo pretējā gadījumā BĒRNS var gūt SMAGAS TRAUMAS vai IET BOJĀ.

ET: ÄRGE kasutage tahapoole suunatud lapseturvaistet istmel, mille ees on AKTIIVSE TURVAPADJAGA kaitstud iste, sest see võib põhjustada LAPSE SURMA või TÕSISE VIGASTUSE.

MT: QATT tuża trażzin għat-fal li jħares lejn in-naħa ta' wara fuq sit protett b' AIRBAG ATTIV quddiemu; dan jista' jikkawża I-MEWT jew GRIEHI SERJI lit-TFAL.

GA: Ná húsáid srian sábháilteachta linbh cúil RIAMH ar shuíochán a bhfuil mála aeir ag feidhmiú os a chomhair. Tá baol BÁIS nó GORTÚ DONA don PHÁISTE ag baint leis.

Beyond the warning required by ECE R94.02, for safety reasons a forward-facing child restraint system must only be used subject to the instructions and restrictions in the table ⇨ 66.

The airbag label may be located on both sides of the front passenger sun visor.

⚠ Danger

Do not use a child restraint system on the passenger seat with active front airbag.

Airbag deactivation ⇨ 62.

Front airbag system

The front airbag system consists of one airbag in the steering wheel and one in the instrument panel on the front passenger side. These can be identified by the word **AIRBAG**.



Additionally there is a warning label on the side of the instrument panel, visible when the front passenger door is open.

The front airbag system is triggered in the event of an accident of a certain severity. The ignition must be switched on.

The inflated airbags cushion the impact, thereby reducing the risk of injury to the upper body and head of the front seat occupants considerably.

⚠ Warning

Optimum protection is only provided when the seat is in the proper position.

Seat position ⇨ 45.

Keep the area in which the airbag inflates clear of obstructions.

Fasten the seat belt correctly and engage securely. Only then is the airbag able to protect.

Side airbag system

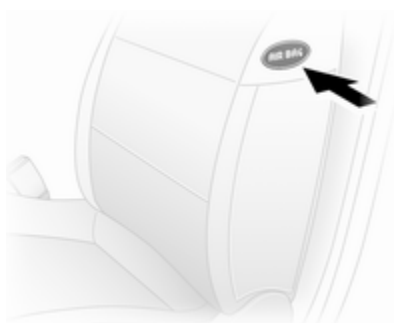

The side airbag system consists of an airbag in each front seat backrest. This can be identified by the word **AIRBAG**.

The side airbag system is triggered in the event of an accident of a certain severity. The ignition must be switched on.

The inflated airbags cushion the impact, thereby reducing the risk of injury to the upper body and pelvis in the event of a side-on collision considerably.

⚠ Warning

Keep the area in which the airbag inflates clear of obstructions.

Notice

Only use protective seat covers that have been approved for the vehicle. Be careful not to cover the airbags.

Airbag deactivation

Front airbag and side airbag systems for the front passenger seat must be deactivated if a child restraint system is to be fitted on this seat, in accordance with the instructions in the child restraint installation location tables ⇨ 66.

The belt pretensioners and all driver airbag systems will remain active.

The front passenger airbag system can be deactivated via a switch on the side of the instrument panel.



With the ignition off, open the front door, push switch in and rotate anticlockwise to the **OFF** position.



Front passenger seat airbags are deactivated and will not inflate in the event of a collision. Control indicator  illuminates continuously and a corresponding message appears in the Driver Information Centre \diamond 104.





A child restraint system can be installed in accordance with the installation locations chart \diamond 66. An adult must not occupy the front passenger seat.

Danger

Deactivate passenger airbag only in combination with the use of a child restraint system, subject to the instructions and restrictions in the table \diamond 66.

Otherwise, there is a risk of fatal injury for a person occupying a seat with a deactivated front passenger airbag.

As long as control indicator  is illuminated, the airbag systems for the front passenger seat will inflate in the event of a collision.

If control indicator  remains illuminated together with , this indicates a fault within the system. The switch position may have been changed inadvertently with the ignition on. Turn ignition off and on again and reset the switch position. If  and  still remain illuminated, seek the assistance of a workshop.

Change status only when the vehicle is stopped with the ignition off. Status remains until the next change.

Control indicator  for airbag deactivation \diamond 97.

Child restraints

Child restraint systems

⚠ Warning

When using a child restraint system on the front passenger seat, the airbag systems for the front passenger seat must be deactivated; if not, the triggering of the airbags poses a risk of fatal injury to the child.

This is especially the case if rear-facing child restraint systems are used on the front passenger seat.

Airbag deactivation ⇨ 62.

Airbag label ⇨ 58.

We recommend a child restraint system which is tailored specifically to the vehicle. For further information, contact your workshop.

When a child restraint system is being used, pay attention to the following usage and installation instructions and also those supplied with the child restraint system.

Always comply with local or national regulations. In some countries, the use of child restraint systems is forbidden on certain seats.

Child restraint systems can be fastened with:

- Three-point seat belt
- ISOFIX brackets
- Top-Tether

Three-point seat belt

Child restraint systems can be fastened by using a three-point seat belt ⇨ 55.

Depending on the size of the used child restraint systems and the model variant, child restraint systems can be attached to certain 2nd row and 3rd row rear seats. After fastening the child restraint system the seat belt has to be tightened ⇨ 66.

ISOFIX child restraint systems

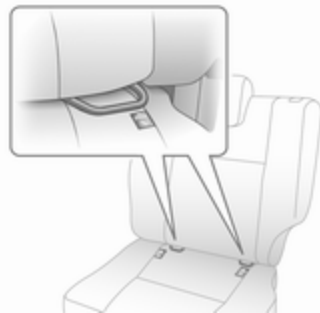

Fasten vehicle-approved ISOFIX child restraint systems to the ISOFIX mounting brackets.

When using ISOFIX mounting brackets for seat mounting, universally approved child restraint systems for ISOFIX may be used.

A Top-Tether strap must be used in addition to the ISOFIX mounting brackets.

Permissible mounting location positions for ISOFIX child restraint systems are marked in the tables by +, IL and IUF.

Top-Tether anchors

Top-Tether anchors are located on the back of the seat.

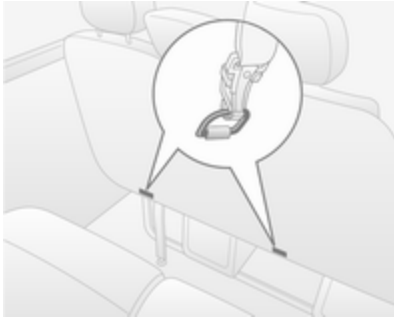

In addition to the ISOFIX mounting, fasten the Top-Tether strap to the Top-Tether anchors.

ISOFIX child restraint systems of universal category positions are marked in the table by IUF ⇨ 66.

Selecting the right system

The rear seats are the most convenient location to fasten a child restraint system.

Children should travel facing rearwards in the vehicle as long as possible. This makes sure that the child's backbone, which is still very weak, is under less strain in the event of an accident.

Suitable are restraint systems that comply with valid UN ECE regulations. Check local laws and regulations for mandatory use of child restraint systems.

Ensure that the child restraint system to be installed is compatible with the vehicle type.

Ensure that the mounting location of the child restraint system within the vehicle is correct, see following tables.

Allow children to enter and exit the vehicle only on the side facing away from the traffic.

When the child restraint system is not in use, secure the seat with a seat belt or remove it from the vehicle.

Notice

Do not affix anything on the child restraint systems and do not cover them with any other materials.

A child restraint system which has been subjected to stress in an accident must be replaced.

Child locks ⇨ 29.

Child restraint installation locations

Permissible options for fitting a child restraint system

Front seats - All variants

Weight and age class	Single seat - front passenger side ¹⁾		Bench seat - front passenger side			
	without airbag	with airbag	without airbag		with airbag	
			centre	outer	centre	outer
Group 0: up to 10 kg	U	U ²⁾	U	U	U ²⁾	U ²⁾
Group 0+: up to 13 kg	U	U ²⁾	U	U	U ²⁾	U ²⁾
Group I: 9 to 18 kg	U	U ²⁾	U	U	U ²⁾	U ²⁾
Group II: 15 to 25 kg	U	U ²⁾	U	U	U ²⁾	U ²⁾
Group III: 22 to 36 kg	U	U ²⁾	U	U	U ²⁾	U ²⁾

- 1) If adjustable, ensure seat is in its rearmost position. Make sure vehicle seat belt is as straight as possible between shoulder and upper anchorage point.
- 2) Ensure the front passenger airbag system is deactivated when installing a child restraint in this position.

Crew van - rear seats**Weight and age class****2nd row seats****Outer****Centre**

Group 0: up to 10 kg

U

X

Group 0+: up to 13 kg

Group I: 9 to 18 kg

U

X

Group II: 15 to 25 kg

U

X

Group III: 22 to 36 kg

68 Seats, restraints

Combi - rear seats

Weight and age class	2nd row seats			3rd row seats
	Driver side outer seat	Centre seat	Passenger side outer seat	
Group 0: up to 10 kg	U ³⁾ , +	X	X	X
Group 0+: up to 13 kg				
Group I: 9 to 18 kg	U ⁴⁾ , +	UF ⁴⁾ , +	UF ⁴⁾	X
Group II: 15 to 25 kg	U ⁴⁾	UF ⁴⁾	UF ⁴⁾	X
Group III: 22 to 36 kg				

3) Move the front seat as far forward as possible to install a rear facing child seat, then move back the seat in front in accordance with the child seat instructions.

4) Forward facing child seat; position the seatback of the child seat in contact with the seatback of the vehicle seat. Adjust the height of the headrest or remove it if necessary; do not push the seat in front of the child more than halfway back on its runners and do not recline the seatback more than 25°.

Bus - rear seats

Weight and age class	Rear seats
Group 0: up to 10 kg	X
Group 0+: up to 13 kg	
Group I: 9 to 18 kg	X
Group II: 15 to 25 kg	X
Group III: 22 to 36 kg	

Crew cab - rear seats

Weight and age class

2nd row seats

Outer

Centre

Group 0: up to 10 kg

U

X

Group 0+: up to 13 kg

Group I: 9 to 18 kg

U

X

Group II: 15 to 25 kg

U

X

Group III: 22 to 36 kg

- U : suitable for universal category restraint systems for use in this weight and age class, in conjunction with three-point seat belt.
- UF : suitable for universal category forward-facing restraint systems for use in this weight and age class, in conjunction with three-point seat belt.
- ⊕ : suitable for ISOFIX child restraint system with mounting brackets and anchorage points, where fitted. When mounting an ISOFIX child restraint system, only systems that have been approved for the vehicle may be used. Refer to "**Permissible options for fitting an ISOFIX child restraint system**".
- X : seat position not suitable for children in this weight and age class.

70 Seats, restraints

Permissible options for fitting an ISOFIX child restraint system

Combi

Weight class	Size class	Fixture	Front seats	2nd row seats			3rd row seats
				Driver side outer seat	Centre seat	Passenger side outer seat	
Group 0: up to 10 kg	E	ISO/R1	X	IL	X	X	X
Group 0+: up to 13 kg	E	ISO/R1	X	IL	X	X	X
	D	ISO/R2	X	IL	X	X	X
	C	ISO/R3	X	IL	X	X	X
Group I: 9 to 18 kg	D	ISO/R2	X	IL	X	X	X
	C	ISO/R3	X	IL	X	X	X
	B	ISO/F2	X	IL, IUF	IL, IUF	X	X
	B1	ISO/F2X	X	IL, IUF	IL, IUF	X	X
	A	ISO/F3	X	IL, IUF	IL, IUF	X	X

IL : suitable for particular ISOFIX restraint systems of the "specific-vehicle", "restricted" or "semi-universal" categories.
The ISOFIX restraint system must be approved for the specific vehicle type.

IUF : suitable for ISOFIX forward-facing child restraint systems of universal category approved for use in this weight class.

X : no ISOFIX child restraint system approved in this weight class.

ISOFIX size class and seat device

- A - ISO/F3 : forward-facing child restraint system for children of maximum size in the weight class 9 to 18 kg.
- B - ISO/F2 : forward-facing child restraint system for smaller children in the weight class 9 to 18 kg.
- B1 - ISO/F2X : forward-facing child restraint system for smaller children in the weight class 9 to 18 kg.
- C - ISO/R3 : rear-facing child restraint system for children of maximum size in the weight class up to 18 kg.
- D - ISO/R2 : rear-facing child restraint system for smaller children in the weight class up to 18 kg.
- E - ISO/R1 : rear-facing child restraint system for young children in the weight class up to 13 kg.

Storage

Storage compartments	72
Instrument panel storage	72
Glovebox	73
Cupholders	73
Front storage	73
Overhead console	74
Underseat storage	74
Overcab storage	75
Load compartment	75
Lashing eyes	76
Cargo management system	77
Safety net	79
Load compartment grille	79
Warning triangle	80
First aid kit	80
Fire extinguisher	80
Roof rack system	81
Roof rack	81
Loading information	81

Storage compartments

⚠ Warning

Do not store heavy or sharp objects in the storage compartments. Otherwise vehicle occupants could be injured by objects being thrown around in the event of hard braking, a sudden change in direction or an accident.

Instrument panel storage

Storage compartments, pockets and trays are located in the instrument panel.

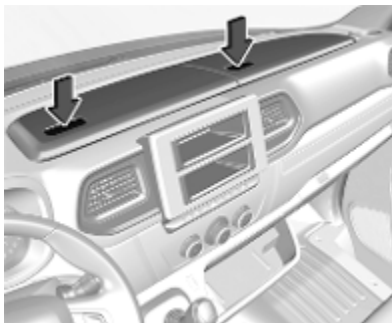

Storage compartments can be located on top of the instrument panel.

Document holder



Withdraw the document holder from the instrument panel by pulling the base to the rear and then swivelling it downwards.

To fold away, raise the base until the document holder is horizontal, then push fully in.

Tray



Press at the front to open.

Do not place any hard or heavy objects on the tray.

Glovebox



Depending on the version, pull the handle or press the button to open the glovebox.

The glovebox should be closed whilst driving.

On some versions the glovebox is ventilated.

Glovebox cooler ⇨ 221.

Cupholders

Cupholders are located at either end of the instrument panel and centrally in the lower instrument panel.



Press at the front to open.

Additionally, cupholders may be located in the rear side of the front centre passenger seat.

Folding passenger seatback ⇨ 73.

Depending on model, cupholders may also be located in the lower front part of the rear seats.

The cupholders can also be used to hold the portable ashtray unit ⇨ 90.

Front storage

Depending on model, coat hooks or storage nets may be located on the cabin bulkhead.

The front door pockets contain bottle holders.

Folding front centre passenger seatback

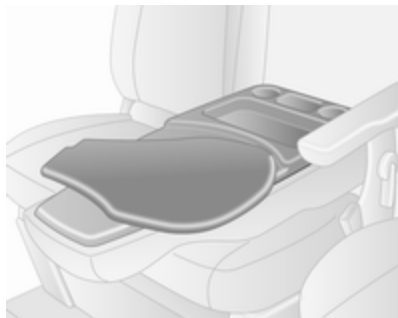

Pull backrest release lever on the front centre passenger seat towards front of vehicle before folding down the backrest to the horizontal position.

The rear side of the backrest features storage compartments, cupholders and a swivelling shelf, which can be used for writing or documents.

Return the swivelling shelf to its original position before pulling backrest release lever and raising the backrest.

Overhead console



The total weight in these compartments must not exceed 5 kg.

Underseat storage



Using the two loops on the passenger seat cushion, pull the cushion forwards to gain access to the storage under the seat.

Rear bench seat

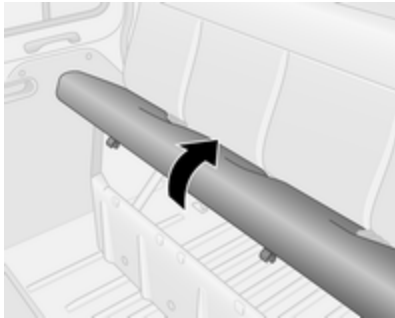

Raise seat base at front and remove to gain access to storage compartment under the bench seat.

Depending on model, bench seats may also contain storage compartments at the lower front part of the seat and a storage net on the outboard side of the seat.

Overcab storage



The total weight in this compartment must not exceed 35 kg.

Rear storage

Combi, Bus

Objects can be stored in the overhead storage compartments above the rear passenger seats.

The total weight must not exceed 20 kg evenly distributed.

Load compartment

Warning

Always make sure that the load in the vehicle is securely stowed. Otherwise objects can be thrown around inside the vehicle and cause personal injury or damage to the load or vehicle.



Use the grab handles, located beside the rear and sliding side door(s), to assist during entry and exit of the load compartment.

Lashing eyes

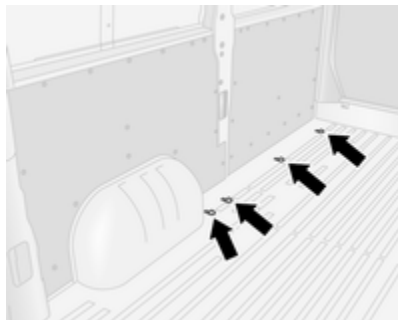

Lashing eyes are mounted in the load compartment to enable cargo to be secured in position using lashing straps or a lugging floor net.

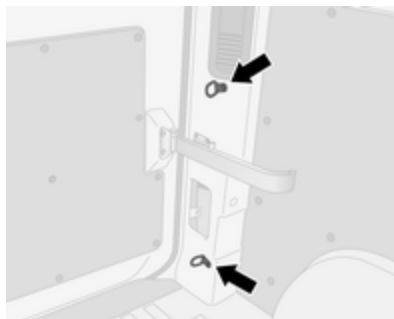

Lashing eyes may be located on the vehicle floor and / or in the sidewall. The number and location of the lashing eyes may vary depending on the vehicle.

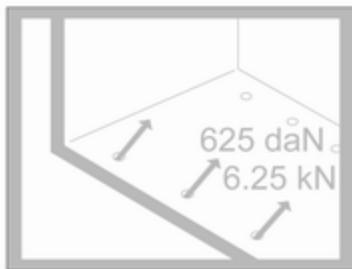

The maximum force applied to the lashing eyes should not exceed 625 daN/6.25 kN/6250 N.

Depending on country, the maximum force (e.g. 500 daN/5 kN/5000 N) may be shown on a label.

Notice

Specifications on the label always have priority over those given in this manual.

Loading information ⇨ 81.

Removable lashing eyes

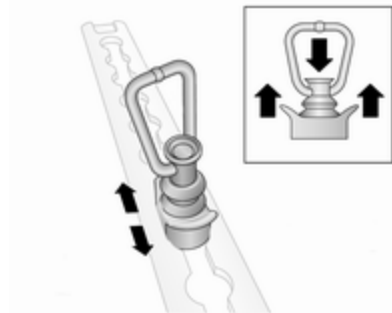

The removable lashing eyes can be secured to the side, floor or roof load rails. Refer to "Cargo management system" below for further information.

To reposition, press down on the centre cap and slide to the desired position. Ensure the lashing eyes engage correctly in the recesses.

Loading information ⇨ 81.

Cargo management system

Depending on vehicle, objects in the load compartment can be secured into position or prevented from sliding excessively by attaching the appropriate cargo management feature to the side, floor or roof load rails using removable lashing eyes (if required).

Lower and also upper side load rails may be present, depending on version.

Moveable partition wall

The moveable partition wall can be used between the floor and roof load rails.

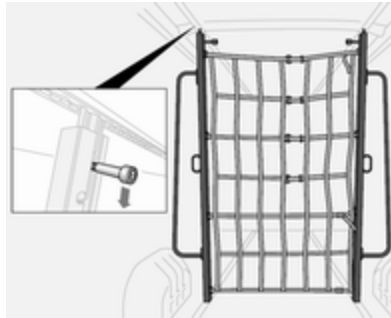

To move, pull down on the latch to release and position the wall as required. Ensure the latch engages fully and the partition wall is upright.



Store the partition wall to one side of the load compartment when not in use.

Telescopic blocking bars

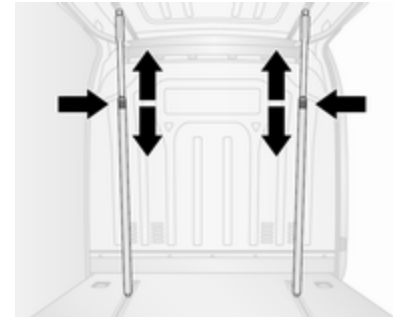

The telescopic blocking bars can be used in a vertical position, secured to the floor and roof load rails.

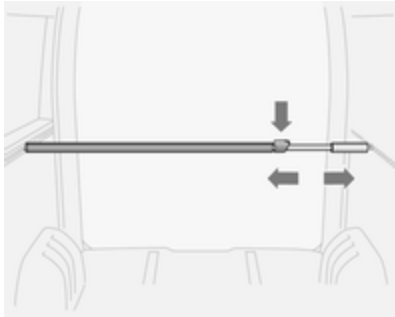

Or the telescopic blocking bars can be used in a horizontal position, secured to the side load rails.

Ensure the blocking bars are fully engaged in the load rails before loading the vehicle.

To release, press down on the lock and slide the bar at the same time.

The maximum loading for the side load rails is 100 daN/700 mm.

Blocking capacity: 300 kg.

Blocking bar with safety net

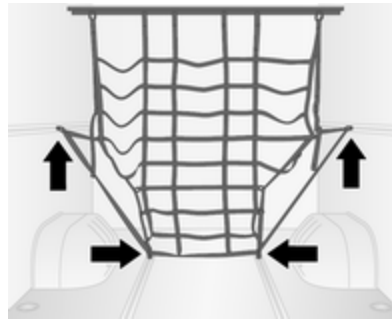

The blocking bar can be secured to the upper side load rails; rotate handle to fix blocking bar into position. Ensure blocking bar engages fully.

The integrated safety net can then be attached to the removable lashing eyes in the side and floor load rails (see illustration).

Ratchet straps

Using the appropriate ratchet straps, objects can be secured in position using the removable lashing eyes in the side or floor load rails.

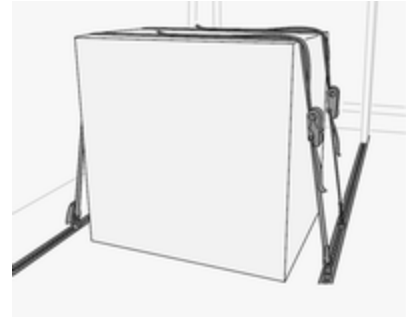

The maximum loading for the floor load rails is 500 daN/700 mm.

Lashing capacity: 800 daN in strapping.

Steel fastener capacity: 170 daN in direct tension.

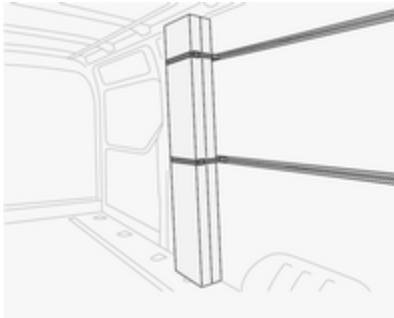

The maximum loading for the side load rails is 100 daN/700 mm.

Lashing capacity: 300 daN in strapping.

Removable lashing eyes ⇨ 76.

Loading information ⇨ 81.

Safety net



Lower the safety net from the roof area and attach to the lashing eyes in the vehicle floor ⇨ 76.

Adjust the tension on the straps to ensure the load is secure.

When not in use the safety net should be stored in the roof area.

Loading information ⇨ 81.

Load compartment grille



Vehicles with a window in the cabin bulkhead may include a metal grille on the load compartment side.

The grille provides protection from load compartment objects being thrown around in the event of hard braking, a sudden change in direction or an accident.



Depending on version, the windows in the rear door and sliding side door(s) also contain window guards, for additional protection and security.

Loading information ⇨ 81.

Warning triangle

The warning triangle can be accommodated in the space under the front seats.

Underseat storage ⇨ 74.

First aid kit

As a visible indication of the presence of a first aid kit, a label may be located on the overhead console ⇨ 74.

The first aid kit can be accommodated in the space under the front seats.

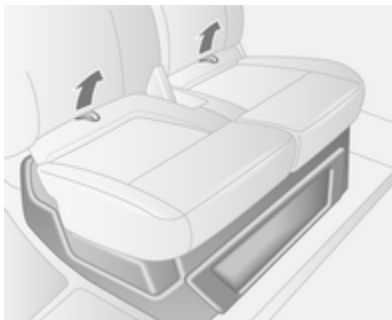

Using the two loops on the seat cushion, pull the cushion forwards to gain access.

Underseat storage ⇨ 74.

Depending on version, the first aid kit may alternatively be located in the space between the front seats or in the overhead console.

Fire extinguisher

As a visible indication of the presence of a fire extinguisher, a label may be located on the overhead console ⇨ 74.

The fire extinguisher can be accommodated in the space under the front seats. Using the two loops on the seat cushion, pull the cushion forwards to gain access.

Underseat storage ⇨ 74.

Depending on version, the fire extinguisher may alternatively be located in the space between the front seats.

An additional fire extinguisher may be located in the front door panel or in the load compartment.

Roof rack system

Roof rack

For safety reasons and to avoid damage to the roof, the vehicle approved roof rack system is recommended.

Follow the installation instructions and remove the roof rack when not in use.

Loading information

- Heavy objects in the load compartment should be evenly distributed and placed as far forward as possible. If objects can be stacked, the heavier objects should be placed at the bottom.
- Secure objects with lashing straps attached to lashing eyes ⇨ 76.
- Secure objects into position or prevent loads from sliding excessively by attaching optional cargo management features to the load rails using removable lashing eyes.
Cargo management system ⇨ 77.
- Secure loose objects in load compartment to prevent them from sliding.
- The load must not obstruct the operation of the pedals, parking brake and gear selector lever, or

hinder the freedom of movement of the driver. Do not place any unsecured objects in the interior.

- Do not drive with an open load compartment. In addition, the number plate is only distinguishable and illuminated correctly if the doors are closed.

Warning

Always make sure that the load in the vehicle is securely stowed. Otherwise objects can be thrown around inside the vehicle and cause personal injury or damage to the load or vehicle.

- The payload is the difference between the permitted gross vehicle weight (see identification plate ⇨ 314) and the EC kerb weight.

To calculate the payload, enter the data for your vehicle in the Weights table at the front of this manual.

The EC kerb weight includes weights for the driver (68 kg),

luggage (7 kg) and all fluids (fuel tank 90% full).

Optional equipment and accessories increase the kerb weight.

- Driving with a roof load increases the sensitivity of the vehicle to cross-winds and has a detrimental effect on vehicle handling due to the vehicle's higher centre of gravity. Distribute the load evenly and secure it properly with retaining straps. Adjust the tyre pressure and vehicle speed according to the load conditions. Check and retighten the straps frequently. Do not drive faster than 75 mph.
- The permissible roof load (which includes the weight of the roof rack) is 200 kg for standard roof variants. The roof load is the combined weight of the roof rack and the load.

Instruments and controls

Controls 84

Steering wheel adjustment	84
Steering wheel controls	84
Horn	84
Steering column controls	84
Windscreen wiper and washer ..	85
Outside temperature	86
Clock	87
Power outlets	87
Inductive charging	89
Cigarette lighter	90
Ashtrays	90

Warning lights, gauges and indicators 90

Instrument cluster	90
Speedometer	90
Odometer	91
Trip odometer	91
Tachometer	91
Fuel gauge	92
AdBlue gauge	92
Engine coolant temperature gauge	92
Service display	93

Transmission display	93
Control indicators	94
Turn lights	97
Seat belt reminder	97
Airbag and belt tensioners	97
Airbag deactivation	97
Charging system	98
Malfunction indicator light	98
Service vehicle soon	98
Stop engine	99
Brake system	99
Parking brake	99
Antilock brake system (ABS)	99
Gear shifting	99
Variable effort steering	99
Lane departure warning	100
Electronic Stability Control	100
Engine coolant temperature ...	100
Preheating	100
AdBlue	100
Tyre pressure monitoring system	101
Engine oil pressure	101
Low fuel	102
Stop-start system	102
Exterior light	102
Low beam	102
High beam	102
High beam assist	102
Front fog lights	102

Rear fog light	102
Cruise control	102
Active emergency braking	103
Speed warning	103
Speed limiter	103
Tachograph	103
Door open	103

Displays 104

Driver Information Centre	104
Info Display	104

Vehicle messages 105

Warning chimes	106
----------------------	-----

Trip computer 107

Tachograph 108

Controls

Steering wheel adjustment

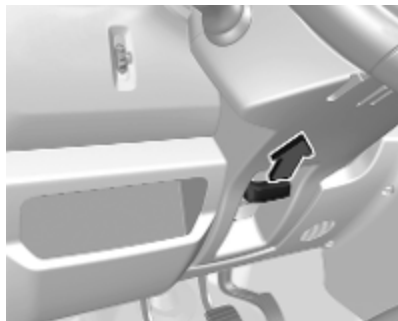

Unlock lever, adjust steering wheel, then engage lever and ensure it is fully locked.

Do not adjust steering wheel unless vehicle is stationary and steering wheel lock has been released.

Steering wheel controls

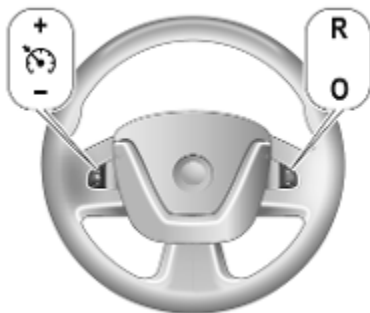

The cruise control and speed limiter can be operated via the controls on the steering wheel.

Cruise control ⇨ 248.

Speed limiter ⇨ 250.

Horn



Press .

The horn will sound regardless of ignition switch position.

Steering column controls

The Infotainment system can also be operated via the controls on the steering column.

Further information is available in the Infotainment manual.

Windscreen wiper and washer

Windscreen wiper

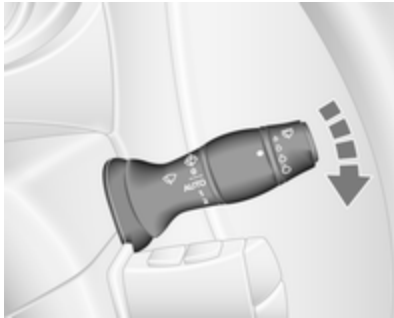

- 0 : off
 0/AUTO : timed interval wiping or automatic wiping with rain sensor
 1 : slow
 2 : fast

Do not use if the windscreen is frozen.
 Switch off in car washes.

Notice

During driving, wiper speed is reduced automatically when the vehicle is at a standstill. As soon as the vehicle starts to move, wiping returns to the selected speed unless the lever has been moved.

Adjustable delay of timed interval wiping

 : timed interval wiping

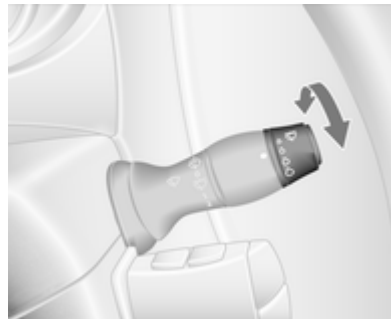

Turn the adjuster wheel to adjust the delay between wipes:

- longer delay : turn adjuster wheel downwards
 shorter delay : turn adjuster wheel upwards

Automatic wiping with rain sensor

AUTO : automatic wiping with rain sensor

The rain sensor detects the amount of water on the windscreen and automatically regulates the frequency of the windscreen wipers.

Notice

During extreme weather conditions, e.g. fog or snow, automatic wiping with rain sensor may become unavailable. If required, select another wiper position.

Adjustable sensitivity of the rain sensor

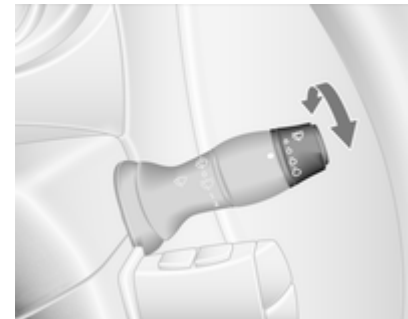

Turn the adjuster wheel to adjust the sensitivity:

- low sensitivity : turn adjuster wheel downwards
- high sensitivity : turn adjuster wheel upwards

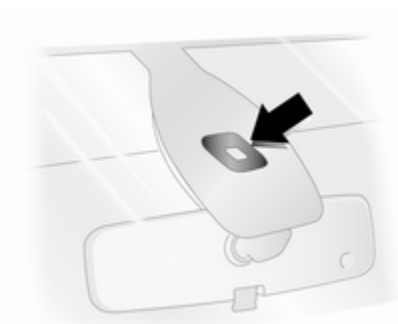

Keep the sensor free from dust, dirt and ice.

Windscreen washer

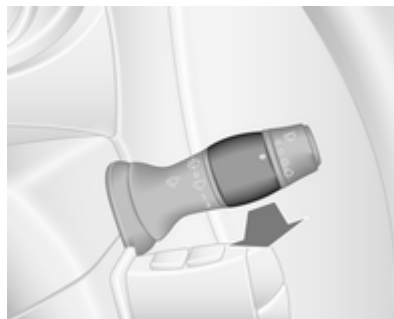

Pull lever. Washer fluid is sprayed onto the windscreen.

- short pull : wiper swipes once
- long pull : wiper swipes for a few strokes

Outside temperature

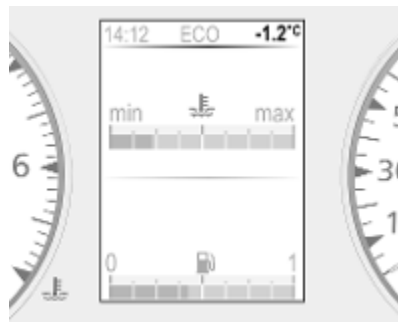

The outside temperature is displayed in the Driver Information Centre or in the Info Display. A drop in temperature is indicated immediately and a rise in temperature after a time delay.

If outside temperatures is $-3\text{ }^{\circ}\text{C}$ to $3\text{ }^{\circ}\text{C}$, the $^{\circ}\text{C}$ flashes in the display as a warning for icy road conditions.

⚠ Warning

The road surface may already be icy even though the display indicates a few degrees above 0 °C.

Clock

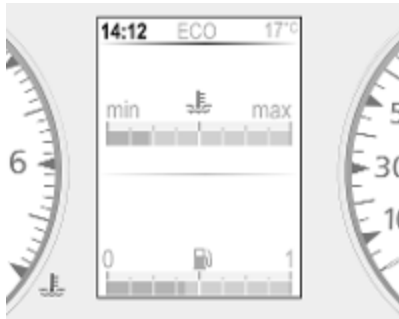

Depending on vehicle, the current time and / or date may appear in the Info Display ↗ 104 or the Driver Information Centre ↗ 104.

Set time and date in information display

Further information is available in the Infotainment manual.

Set time in Driver Information Centre



Display the clock function by pressing control button repeatedly on end of wiper lever.

- Press and hold one of the buttons until hours flash.
- Press or hold one of the buttons to set the hour.
- Wait until minutes flash.

- Press or hold one of the buttons to set the minute.
- Wait before selecting another function.

Power outlets



12 V power outlets are located on top of the instrument panel, or beside the gearshift lever.



Depending on vehicle, an additional outlet may be located in the rear of the vehicle.

Connecting electrical accessories while the engine is off will discharge the vehicle battery. Do not exceed the maximum power consumption of 120 W.

⚠ Danger

To avoid the risk of fire, if multiple power outlets are used simultaneously, the total power consumption of connected accessories must not exceed 180 W.

With ignition off the power outlet may be deactivated.

Additionally, the power outlet may be deactivated in case of low battery voltage.

Electrical accessories that are connected must comply with the electromagnetic compatibility requirements laid down in DIN VDE 40 839.

Caution

Do not connect any current-delivering accessories, e.g. electrical charging devices or batteries.

Do not damage the outlets by using unsuitable plugs.

USB socket



In the Infotainment unit or on the instrument panel there is a USB socket Ψ for the connection of external audio sources and for charging devices.

**Notice**

The sockets must always be kept clean and dry.

AUX socket, SD card slot – refer to the Infotainment manual.

Inductive charging**⚠ Warning**

Inductive charging can affect the operation of implanted pacemakers or other medical devices. If applicable, seek medical advice before using the inductive charging device.

⚠ Warning

Remove any metal objects from the charging device before charging a mobile device, as these objects could become very hot.



To charge a device, the ignition must be switched on.

To charge a mobile device:

1. Remove all objects from the charging device.
2. Place the mobile device with the display facing upwards on the charging device in the storage.

Charging status may be indicated in the Info Display.

PMA or Qi compatible mobile devices can be charged inductively.

On some mobile devices, a back cover with an integrated coil or a jacket may be required to use inductive charging.

Protective cover for the mobile device could have impact on the inductive charging.

In the event that the mobile device is not charging properly, rotate it 180° and place it on the charging device again.

Cigarette lighter



Press in cigarette lighter. It switches off automatically once the element is glowing. Pull out lighter.

Ashtrays

Caution

To be used only for ash and not for combustible rubbish.

Portable ashtray



Ashtray container for mobile use in the vehicle. To use, open cover.

Warning lights, gauges and indicators

Instrument cluster

In some versions, the needles of the instruments briefly rotate to the end position when the ignition is switched on.

Speedometer



Indicates vehicle speed.

Speed warning ⇨ 103.

Speed limiter ⇨ 250.

Cruise control ⇨ 248.

Odometer



Displays the recorded distance in miles.

Notice

When a tachograph is fitted, the total distance travelled may be shown only on the tachograph.

Trip odometer

The trip odometer displays the distance travelled since the last reset.

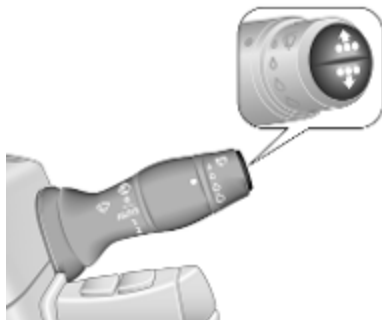

To reset, with the trip odometer displayed, press and hold one of the buttons on end of wiper lever until the value resets to 0.

Trip computer ↪ 107.

Tachometer



Displays the engine speed.

Drive in a low engine speed range for each gear as much as possible.

Caution

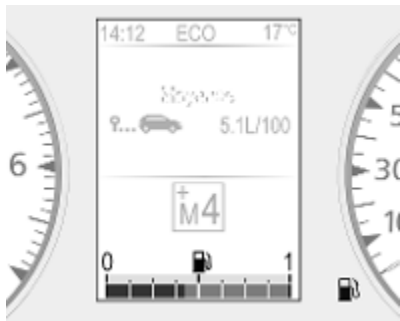

If the needle is in the red warning zone, the maximum permitted engine speed is exceeded. Engine at risk.

Fuel gauge



Displays fuel level in the tank.

Depending on vehicle content are different designs used.

Control indicator  illuminates and a warning chime sounds if the level in the tank is low. Refuel immediately  262.

Never run the tank dry.



Diesel fuel system bleeding  275.

Because of the fuel remaining in the tank, the top-up quantity may be less than the specified tank capacity.

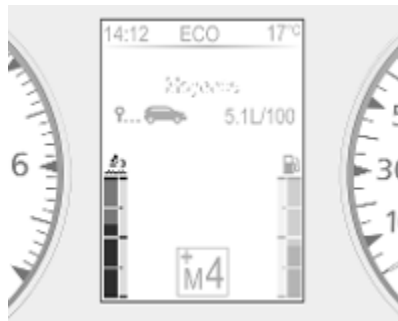
AdBlue gauge



AdBlue gauge shows the current AdBlue fluid level remaining in the tank.

Control indicator   100 illuminates and a warning chime sounds if the level in the tank is low. Refill AdBlue as soon as possible to avoid prevention of engine starts.

AdBlue  233.

Engine coolant temperature gauge

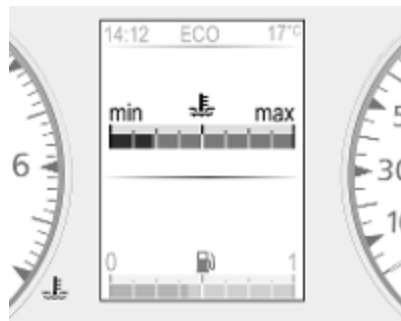





Displays the coolant temperature.

left area : engine operating temperature not yet reached

central : normal operating area temperature

right area : temperature too high

Control indicator  illuminates red if the temperature is too high  100.

If  illuminates red in combination with STOP, stop vehicle and switch off engine as soon as possible  99.

Caution

If engine coolant temperature is too high, stop vehicle, switch off engine. Danger to engine. Check coolant level.

For physical reasons, the coolant temperature gauge shows the coolant temperature only if the coolant level is adequate.

Service display

Select the service page in the Driver Information Centre, when the ignition is switched on without running engine. Press and hold one of the buttons on end of wiper lever for approx. 5 seconds ⇨ 107. The distance and time to the next service are displayed. Pressing then lower button, shows the information for the next engine oil change.

When the ignition is switched on, the remaining distance or time before the next service is due may be shown briefly in the Driver Information

Centre. Based on driving conditions, the interval at which a service will be indicated can vary considerably.

When the remaining distance before the next service is less than 930 miles or 1 month, a message appears in the Driver Information Centre.

When the distance reaches 0 miles or the service date is due, control indicator  illuminates and a message appears in the Driver Information Centre.

The vehicle needs a service. Seek the assistance of a workshop.

Resetting the service display

After a service or an engine oil change, the values must be reset: select the relevant information in the Driver Information Centre, then press and hold one of the buttons on end of wiper lever for approx. 10 seconds until the distance is displayed continuously.

Trip computer ⇨ 107.



Driver Information Centre ⇨ 104.

Service information ⇨ 310.

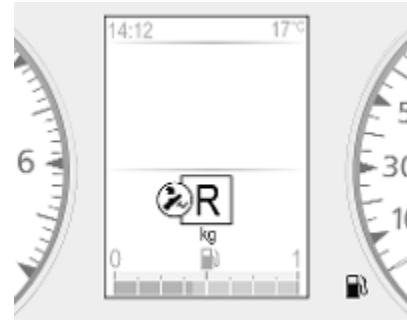
Transmission display



The mode or selected gear of the manual transmission automated is shown in the transmission display.

- R** : reverse gear
- N** : neutral
- D** : automatic mode
- kg** : laden mode
-  : apply footbrake
-  : transmission electronics

Manual transmission automated
⇨ 240.

Control indicators

The control indicators described are not present in all vehicles. The description applies to all instrument versions. Depending on the equipment, the position of the control indicators may vary. When the ignition is switched on, most control indicators will illuminate briefly as a functionality test.

The control indicator colours mean:

- red : danger, important reminder
- yellow : warning, information, fault
- green : confirmation of activation
- blue : confirmation of activation
- white : confirmation of activation



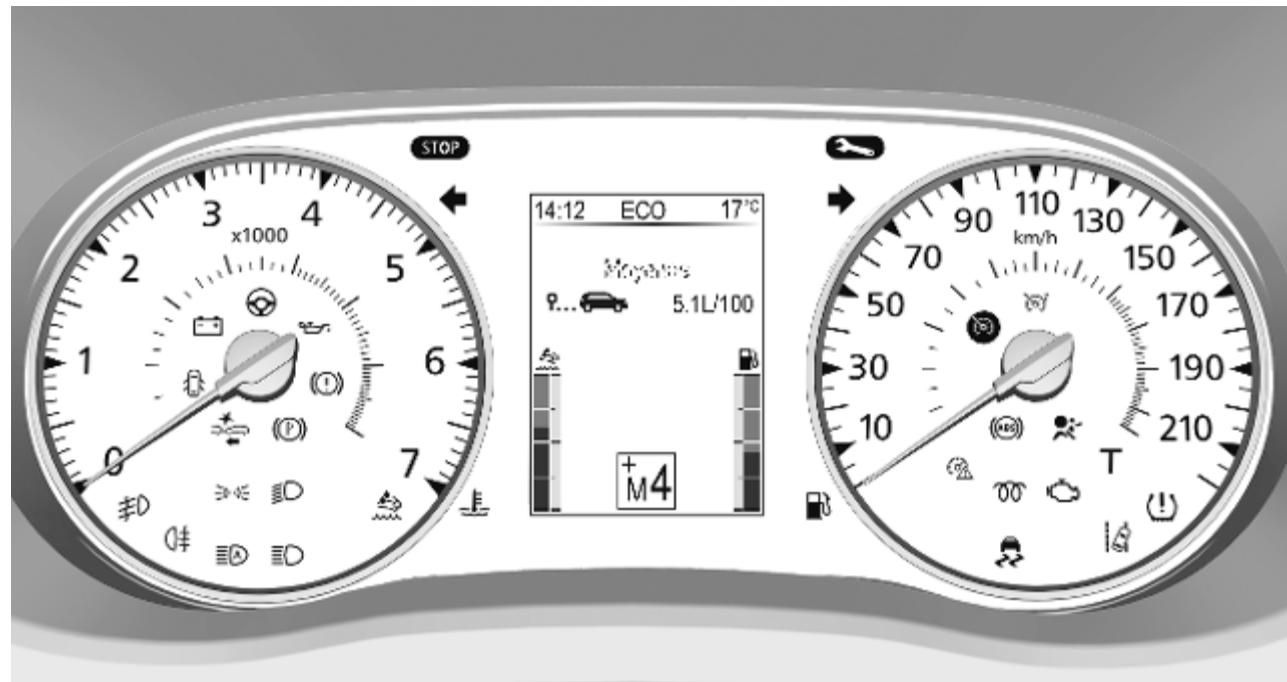



Control indicators in the instrument cluster





























Control indicators in the overhead console



Overview

-  Turn lights ⇨ 97
-  Seat belt reminder ⇨ 97
-  Airbag and belt tensioners ⇨ 97
-  Airbag deactivation ⇨ 97
-  Charging system ⇨ 98
-  Malfunction indicator light ⇨ 98

-  Service vehicle soon ⇨ 98
- STOP** Stop engine ⇨ 99
-  Brake system ⇨ 99
-  Parking brake ⇨ 99
-  Antilock brake system (ABS) ⇨ 99
-  Gear shifting ⇨ 99
-  Variable effort steering ⇨ 99
-  Lane departure warning ⇨ 100
-  Electronic Stability Control ⇨ 100
-  Engine coolant temperature ⇨ 100
-  Preheating ⇨ 100
-  AdBlue ⇨ 100
-  Tyre pressure monitoring system ⇨ 101
-  Engine oil pressure ⇨ 101

-  Low fuel ⇨ 102
-  Autostop (Stop-start system) ⇨ 102
-  Autostop inhibited (Stop-start system) ⇨ 102
-  Exterior light ⇨ 102
-  Low beam ⇨ 102
-  High beam ⇨ 102
-  High beam assist ⇨ 102
-  Front fog lights ⇨ 102
-  Rear fog light ⇨ 102
-  Cruise control ⇨ 102
-  Active emergency braking ⇨ 103
-  Speed warning ⇨ 103
-  Cruise control ⇨ 102, speed limiter ⇨ 103
- T** Tachograph ⇨ 103
-  Door open ⇨ 103

Turn lights

↔ flashes green.

Flashes if a turn light or the hazard warning flashers are activated.

Rapid flashing: failure of a turn light or associated fuse.

An audible warning can be heard when the turn lights are on. When towing a trailer, the pitch of the audible warning changes.

Bulb replacement ⇨ 276.

Fuses ⇨ 284.

Turn lights ⇨ 112.

Seat belt reminder

 illuminates or flashes red in the overhead console.

If the seat belt is unfastened, control indicator  will flash when vehicle speed exceeds approx. 10 mph. A warning chime also sounds for approx. 90 seconds.

Depending on the vehicle, the control indicator flashes if the front passenger seat belt is not fastened.

If the seat belt is fastened, the indicator light extinguishes.

Warning

Fasten seat belt before each trip. In the event of an accident, people not wearing seat belts endanger their fellow occupants and themselves.

Three-point seat belts ⇨ 55.

Airbag and belt tensioners

 illuminates yellow.

When the ignition is switched on, the control indicator illuminates briefly. If it does not illuminate or illuminates whilst driving, there is a fault in the airbag system. Seek the assistance of a workshop. The airbags and belt pretensioners may fail to trigger in the event of an accident.

Deployment of the belt pretensioners or airbags is indicated by continuous illumination of .

Warning

Have the cause of the fault remedied immediately by a workshop.

Belt pretensioners ⇨ 54.

Airbag system ⇨ 58.

Airbag deactivation

 illuminates yellow.

Illuminates for approx. 60 seconds after the ignition is switched on. The front passenger airbag is activated.

 illuminates yellow when the ignition is switched on and remains illuminated when the front passenger airbag has been deactivated ⇨ 62.

⚠ Danger

Risk of fatal injury for a child using a child restraint system together with activated front passenger airbag.

Risk of fatal injury for an adult person with deactivated front passenger airbag.

Airbag system ⇨ 58.

Belt tensioners ⇨ 54.

Airbag deactivation ⇨ 62.

Charging system

 illuminates red.

Illuminates when the ignition is switched on and extinguishes shortly after the engine starts.

Illuminates when the engine is running

Stop, switch off engine. Vehicle battery is not charging. Engine cooling may be interrupted. The brake servo unit may cease to be effective. Seek the assistance of a workshop.



Malfunction indicator light

 illuminates or flashes yellow.

Illuminates briefly when the ignition is switched on.

Illuminates when the engine is running

Fault in the emission control system. The permitted emission limits may be exceeded. Seek the assistance of a workshop immediately.

If  illuminates in combination with , stop vehicle and switch off engine as soon as possible.

⚠ Warning

Have the cause of the fault remedied immediately by a workshop.

Flashes when the engine is running

Fault that could lead to catalytic converter damage. Ease up on the accelerator until the flashing stops. Seek the immediate assistance of a workshop.

Service vehicle soon

 illuminates yellow.

Illuminates briefly when the ignition is switched on.

The vehicle needs a service.

May illuminate in combination with another control indicator or a message in the Driver Information Centre ⇨ 104.

Illuminates if cleaning of the diesel particle filter is required and automatic cleaning does not occur ⇨ 232.

⚠ Warning

Have the cause of the fault remedied immediately by a workshop.

Stop engine

 illuminates red.

Illuminates briefly when the ignition is switched on.

Stop vehicle and switch off engine as soon as possible.

May illuminate in combination with another control indicator or a message in the Driver Information Centre ⇨ 104.



⚠ Warning

Have the cause of the fault remedied immediately by a workshop.

Brake system

 illuminates red.

Illuminates briefly when the ignition is switched on.

 illuminates (possibly in combination with ) if the brake fluid level is too low ⇨ 273 or brake system has a fault.

⚠ Warning

Stop. Do not continue your journey. Consult a workshop.

Brake system ⇨ 243.

Parking brake

 illuminates red.

Control indicator  remains illuminated when the parking brake is applied and extinguishes when the parking brake is released ⇨ 244.

Antilock brake system (ABS)



 illuminates yellow.

Illuminates briefly when the ignition is switched on. The system is ready for operation when  extinguishes.

Illuminates during driving when there is a fault in the ABS. The brake system remains operational but without ABS regulation.

Antilock brake system ⇨ 243.

Gear shifting

 or  illuminates in the Driver Information Centre.

Illuminates when gearshifting is recommended for fuel saving reasons.

ECO mode ⇨ 224.

Variable effort steering

 illuminates red.

Illuminates briefly when the ignition is switched on.

Illuminates during driving

The power steering system has a fault.

May illuminate together with control indicator .

⚠ Warning

Have the cause of the fault remedied immediately by a workshop.

Lane departure warning

 illuminates yellow.

Illuminates briefly when the ignition is switched on.

Illuminates permanently when the system is switched off.

A warning chime sounds in conjunction with  when the system recognises an unintended lane change.

 illuminates white in the Driver Information Centre when the ignition is switched on and the system is ready to operate.

Lane departure warning ⇨ 260.

Electronic Stability Control

 flashes or illuminates yellow.

Illuminates briefly when the ignition is switched on.

Flashing during driving

The system is actively engaged. Engine output may be reduced and the vehicle may be braked automatically to a small degree ⇨ 247.

Illuminates during driving

The system is unavailable.

May illuminate together with control indicator  ⇨ 98. A corresponding message also appears in the Driver Information Centre ⇨ 104.

ESC ⇨ 247.



Traction Control system ⇨ 246.

Engine coolant temperature

 illuminates blue or red.

Illuminates briefly blue when the ignition is switched on or when engine temperature is low.

Illuminates when the engine is running

If  illuminates red (possibly in combination with control indicator STOP), stop vehicle and allow the engine to idle for 2 minutes.  should extinguish, if not then switch off engine.

Caution

Coolant temperature too high.

Check coolant level ⇨ 272.

If there is sufficient coolant, consult a workshop.

Preheating

 illuminates yellow.

Preheating is activated. Only activates when outside temperature is low.

AdBlue

 illuminates yellow.

AdBlue level is low. Refill AdBlue as soon as possible, to avoid prevention of engine starts.

Illuminates together with control indicator  to indicate a system failure or as a warning that engine starting may not be possible after a certain distance. Seek the assistance of a workshop immediately.

A corresponding message may appear in the Driver Information Centre ↪ 104.

AdBlue ↪ 233.

Tyre pressure monitoring system

 illuminates or flashes yellow.

Illuminates briefly when the ignition is switched on.

Illuminates



Tyre pressure loss. Stop immediately and check tyre pressure.

Control indicator  illuminates together with STOP ↪ 99 and a corresponding message appears in

the Driver Information Centre when a puncture or severely under-inflated tyre is detected.

Flashes

Fault in system. After a delay the control indicator illuminates continuously. Consult a workshop.

Control indicator  illuminates together with  ↪ 98 and a corresponding message appears in the Driver Information Centre when a tyre without a pressure sensor is mounted (e.g. spare wheel).

Tyre pressure monitoring system ↪ 291.

Engine oil pressure

 illuminates red.

Illuminates briefly when the ignition is switched on.

Illuminates when the engine is running

Caution

Engine lubrication may be interrupted. This may result in damage to the engine and/or locking of the drive wheels.

1. Depress clutch.
2. Select neutral gear, set selector lever to **N**.
3. Move out of the flow of traffic as quickly as possible without impeding other vehicles.
4. Switch off ignition.

⚠ Warning

When the engine is off, considerably more force is needed to brake and steer. During an Autostop the brake servo unit will still be operational.

Do not remove key until vehicle is stationary, otherwise the steering wheel lock could engage unexpectedly.

Check engine oil level ⇨ 270.

Keep engine turned off and let the vehicle be towed to a workshop.

Low fuel

 illuminates yellow.

Illuminates when the ignition is switched on and extinguishes shortly after the engine starts.

Illuminates when the engine is running

Fuel level in the tank is too low. Refuel immediately.

Never run the tank dry.

Refuelling ⇨ 262.

Catalytic converter ⇨ 233.

Bleeding the diesel fuel system ⇨ 275.

Stop-start system

 illuminates when an Autostop is inhibited when certain conditions are not fulfilled.

 illuminates during an Autostop.

 flashes if the clutch is not released sufficiently.

Stop-start system ⇨ 227.

Exterior light

 illuminates green.

Illuminated when the side lights are on ⇨ 109.

Low beam

 illuminates or flashes green.

Illuminates

Illuminated when the headlights are on ⇨ 109.

Flashes

Fault in the lighting.

High beam

 illuminates blue.

Illuminated when high beam is on and during headlight flash ⇨ 110.

High beam assist

 illuminates when the high beam assist is activated ⇨ 110.

Front fog lights

 illuminates green.

Illuminated when the front fog lights are on ⇨ 112.

Rear fog light

 illuminates yellow.

Illuminated when the rear fog light is on ⇨ 113.

Cruise control

 ,  illuminate green.

 illuminates green when the system is on.

 illuminates green when a certain speed is stored.

Cruise control ⇨ 248.

Active emergency braking

 illuminates or flashes red.

Illuminates

The system has been deactivated or a fault has been detected.

Additionally, a warning message is displayed in the Driver Information Centre.

In case of a system fault, seek the assistance of a workshop.

Flashes

The system is actively engaged.

Depending on the situation, the vehicle may automatically brake moderately or hard.

Active emergency braking ⇨ 252.

Speed warning

Depending on vehicle and country,  is displayed as long as the speed is over a set value.

Limited speed

Depending on version and country, the maximum speed is set by default.

A warning chime will sound for 10 seconds if the vehicle briefly exceeds the set limit.

Notice

Under certain conditions (e.g. steep inclines) the vehicle speed may exceed the set limit.

Speed limiter ⇨ 250.

Speed limiter

 illuminates yellow.

Illuminates when the system is on.

Speed limiter ⇨ 250.

Tachograph

T illuminates when there is a fault in the system.

Tachograph ⇨ 108.

Door open

 illuminates yellow.

Illuminates with the ignition switched on when a door or the load compartment is open.

Displays

Driver Information Centre

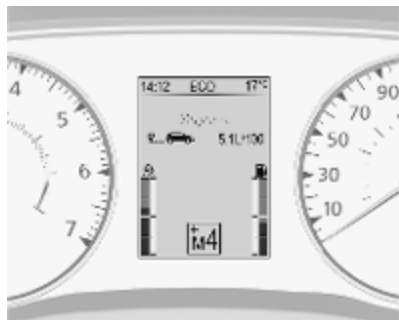

The Driver Information Centre is located in the instrument cluster.

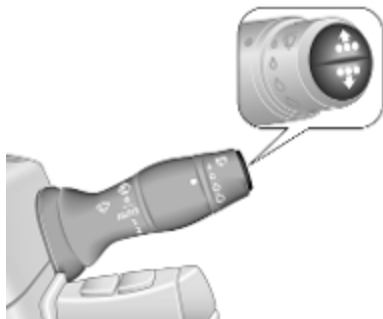

Depending on vehicle configuration, the following items appear by pressing one of the buttons repeatedly on end of wiper lever:

- outside temperature ↻ 86
- clock ↻ 87
- odometer, trip odometer ↻ 91
- fuel gauge ↻ 92
- AdBlue gauge ↻ 92
- engine coolant temperature gauge ↻ 92
- service display ↻ 93
- vehicle messages ↻ 105

- trip computer ↻ 107
- active emergency braking ↻ 252

Some of the displayed functions differ when the vehicle is being driven or at a standstill. Some functions are only available when the vehicle is being driven.

Info Display

The central display in the Infotainment system displays the time (and / or outside temperature, depending on version) and Infotainment system information.

Press  to switch the Infotainment system on. Alternatively, it automatically switches on when the ignition is switched on.

Depending on system, the Infotainment system is operated via buttons and rotary knobs on the Infotainment system fascia, the steering column controls, the voice recognition system (if available) or via the touchscreen display.

Touchscreen operation

Make the appropriate selection from the available menus and options by touching the display screen with the finger.

For further information, refer to the Infotainment system manual.

Journey record

When the engine is switched off, a record of the last journey may be shown in the Info Display.

The following information is displayed:

- average fuel consumption
- trip odometer
- fuel saved in miles

If equipped, a rating of 0 to 100 is shown in the Info Display, to help evaluate fuel efficiency, based on driving style. Higher ratings indicate better fuel economy.

Tips to improve fuel economy are also given in the display. Journeys can be saved in the system memory,

enabling to compare performances. Refer to Infotainment manual for further information.

Vehicle messages

Messages are indicated in the Driver Information Centre, in some cases together with a warning chime. The vehicle messages are displayed as text. Follow the instructions given in the messages.

Fault messages

Displayed in combination with control indicator . Drive with caution and seek the assistance of a workshop.

To remove fault message, press a button on end of wiper lever. After a few seconds the message may disappear automatically and  remains illuminated. The fault will then be stored in the on board system.

Warning messages

These may appear with control indicator  or in combination with other warning messages, control indicators or an audible warning. Stop engine immediately and seek the assistance of a workshop.

Warning chimes

If several warnings appear at the same time, only one warning chime will sound.

When starting the engine or whilst driving

The warning chime regarding unfastened seat belts has priority over any other warning chime.

- If seat belt is not fastened ⇨ 55.
- If a certain speed is exceeded with the parking brake applied ⇨ 244.
- If the parking assist detects an object or a fault is present ⇨ 254.
- If the vehicle has manual transmission automated and the clutch temperature is too high ⇨ 240.
- If the vehicle speed briefly exceeds a set limit ⇨ 90.
- During closing of the power sliding door ⇨ 29.
- If the sliding door is open and the parking brake is released ⇨ 29.

- During activation and deactivation of alarm monitoring of vehicle inclination ⇨ 35.
- If the AdBlue level falls below a certain amount or a fault is present ⇨ 233.
- If the lane departure warning system detects an unintended lane change and when the system is activated ⇨ 260.

When the vehicle is parked and / or the driver's door is opened

- When the key is in the ignition switch.
- With exterior lights on ⇨ 109.
- There is a fault with the power door lock system ⇨ 28.
- If the vehicle has manual transmission automated ⇨ 240, the parking brake has not been applied, neutral is not selected or the brake pedal has not been depressed. A corresponding message may also appear in the Driver Information Centre ⇨ 104.

- If the sliding side door exterior handle is in the open position when unlocking the vehicle ⇨ 29.
- If the parking brake is not applied when the power sliding door switch is pressed ⇨ 29.
- If the power sliding door is locked from the inside with the child lock active ⇨ 29.
- If the engine is in an Autostop but not switched off. Stop-start system ⇨ 227.

Trip computer

The trip computer provides information on driving data, which is continually recorded and evaluated electronically.

Depending on vehicle, the following functions can be selected by pressing one of the buttons repeatedly on end of wiper lever ⇨ 104:

- odometer ⇨ 91
- trip odometer ⇨ 91
- average fuel consumption
- instantaneous fuel consumption
- fuel range
- distance travelled
- average speed
- digital speed
- engine coolant temperature ⇨ 92
- clock ⇨ 87
- distance before service ⇨ 93
- tyre pressure reset ⇨ 291
- settings

- fault and information messages ⇨ 105
- AdBlue range

Average fuel consumption

The value is displayed after driving a distance of 0.25 miles.

Average fuel consumption is displayed, taking into consideration the distance travelled and the fuel used since the last reset.

Instantaneous fuel consumption

The value is displayed after reaching a speed of 12 mph.

Fuel range

The value is displayed after driving a distance of 0.25 miles.

The fuel range is calculated from the current contents of the fuel tank and the average fuel consumption since the last reset.

The fuel range will not display if control indicator  is illuminated ⇨ 102.

Distance travelled

Displays the distance driven since the last reset.

Average speed

The value is displayed after driving a distance of 0.25 miles.

The average speed since the last reset is displayed.

Interruptions in the journey with the ignition off are not included in the calculations.

Reset trip computer information

To reset the trip computer, select one of its functions then press and hold one of the buttons on end of wiper lever.

The following trip computer information can be reset:

- average fuel consumption
- distance travelled
- average speed

The trip computer will reset automatically when the maximum value of any of the parameters is exceeded.

Digital speed

Digital display of the instantaneous speed.

Settings

Press and hold one of the buttons on end of wiper lever for approx. 5 seconds to select the display language.

AdBlue range

The AdBlue range is calculated from the current contents of the AdBlue tank and the average AdBlue consumption ↻ 233.

Interruption of power supply

If the power supply has been interrupted or if the vehicle battery voltage has dropped too low, the values stored in the trip computer will be lost.

Tachograph



The tachograph is operated as described in the operating instructions supplied. Observe regulations regarding use.

Lighting



- Exterior lighting** 109
 - Light switch 109
 - Automatic light control 109
 - High beam 110
 - High beam assist 110
 - Headlight flash 111
 - Headlight range adjustment 111
 - Headlights when driving
 - abroad 111
 - Daytime running lights 112
 - Hazard warning flashers 112
 - Turn lights 112
 - Front fog lights 112
 - Rear fog light 113
 - Reversing lights 113
 - Misted light covers 113
- Interior lighting** 113
 - Interior lights 113
 - Load compartment lighting 114
 - Reading lights 115
- Lighting features** 115
 - Exit lighting 115
 - Battery discharge protection 116

Exterior lighting

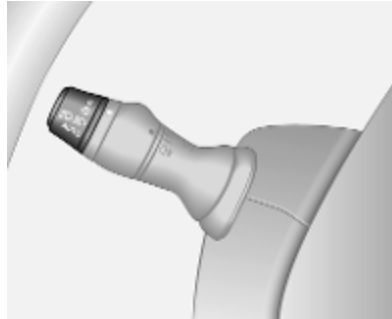
Light switch



Turn outer light switch:

- O** : off
-  : sidelights
-  **HD** : headlights
- AUTO** : automatic light control: headlights are switched on and off automatically.

Sidelights control indicator  \Rightarrow 102.

Low beam control indicator  \Rightarrow 102.

High beam control indicator  \Rightarrow 102.

Side position lights

Side position lights are illuminated together with sidelights.

Automatic light control



When the automatic light control function is switched on and the engine is running, the system switches between daytime running lights (where fitted) and headlights, depending on the lighting conditions.

For reasons of safety, the light switch should always remain in the **AUTO** position.

Daytime running lights \Rightarrow 112.

Automatic headlight activation

During poor lighting conditions the headlights are switched on.

Additionally, headlights are switched on if the windscreen wiper has been activated for several wipes.

High beam

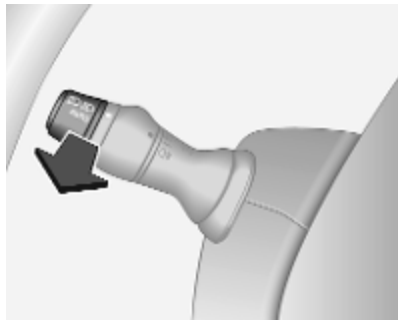

To change between low and high beam, pull lever beyond the resistance point.

High beam assist

This feature automatically activates the high beam at night when vehicle speed is faster than 28 mph.

It switches automatically back to low beam when:



- The camera in the windscreen detects the lights of oncoming or preceding vehicles.
- It is foggy or snowy.
- Driving in urban areas.

If there are no restrictions detected, the system switches back to high beam.

Activation



Turn the outer light switch to **AUTO** then pull the lever to activate high beam assist.

The control indicator  illuminates continuously in the instrument cluster when the assist is activated, while the blue control indicator  102 illuminates when high beam is on.

Control indicator  102.

Notice

Use of the system does not relieve the driver from full responsibility for vehicle operation.

Deactivation

Pull the lever again. Control indicator  extinguishes.

High beam assist is also deactivated when the outer light switch is moved out of the **AUTO** position or the ignition is switched off.

Notice

Depending on version, the system can be also deactivated via the Infotainment system. Refer to Infotainment manual for further information.

General information

Performance of the system can be affected due to the following:

- Extreme weather conditions, e.g. heavy rain, fog or snow.
- The front camera or the windscreen is obstructed, e.g. by a portable navigation system.
- Oncoming or preceding vehicle lights are not detected.
- Headlights are not adjusted correctly.
- Various reflective surfaces may also cause the system to fail to detect other vehicles.

Headlight flash

To activate the headlight flash, pull the lever briefly without passing the resistance point.

High beam ⇨ 110.

Headlight range adjustment

Manual headlight range adjustment

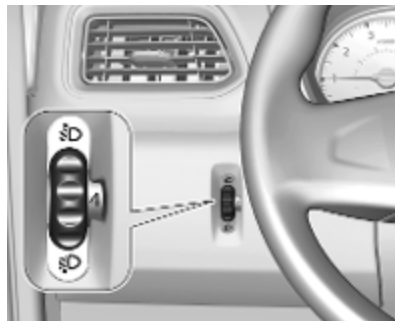

With low beam switched on, adapt the headlight range to suit the vehicle load to prevent dazzling of oncoming traffic.

Turn knurled wheel to proposed position:

- 0 : driver only
- 2 : front seats occupied and loaded up to permissible maximum weight
- 3 : driver only and loaded up to permissible maximum weight

Headlights when driving abroad

The asymmetrical headlight beam extends visibility at the edge of the road at the passenger side.

However, when driving in countries where traffic drives on the opposite side of the road, adjust the headlights to prevent dazzling of oncoming traffic.



Open the bonnet and adjust both headlights with a screwdriver by turning the screw a quarter turn in - direction. Adjust to standard position by turning the screw a quarter turn in + direction.

Daytime running lights

Daytime running lights increase visibility of the vehicle during daylight.

The lights operate automatically when the ignition is switched on.

If the vehicle is equipped with the automatic light control function, the system switches between daytime running lights and headlights automatically depending on the lighting conditions.

Automatic light control ⇨ 109.

Hazard warning flashers



Operated by pressing .

In the event of hard braking, the hazard warning flashers may turn on automatically. Switch off by pressing .

Turn lights

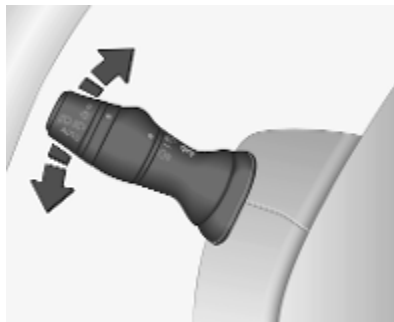

up : right turn light
down : left turn light

A resistance point can be felt when moving the lever.

Constant flashing is activated when the lever is being moved beyond the resistance point. It is deactivated when the steering wheel is moved in

the opposite direction or lever is manually moved back to its neutral position.

Activate temporary flashing by holding the lever just before the resistance point. Turn lights will flash until lever is being released.

To activate three flashes, tap the lever briefly without passing the resistance point.

Front fog lights

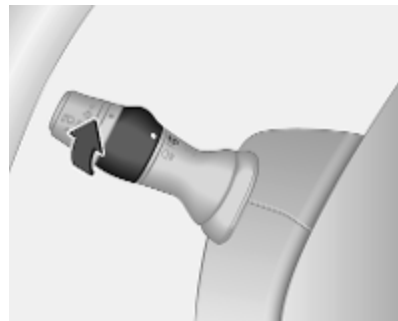

Turn inner switch to position  and release.

Front fog lights operate with engine running and headlights switched on.

Rear fog light

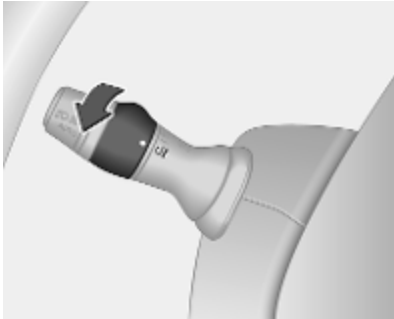

Turn inner switch to position 0 and release.

Rear fog light operates with engine running and headlights switched on.

Reversing lights

The reversing lights come on when the ignition is on and reverse gear is selected.

Misted light covers

The inside of the light covers may mist up briefly in poor, wet and cold weather conditions, in heavy rain or after washing. The mist disappears quickly by itself. To help, switch on the headlights.

Interior lighting

Interior lights

Courtesy lights illuminate when the vehicle is unlocked with the remote control or the front doors are opened.

When the doors are closed, the courtesy light extinguishes after a delay or immediately after the ignition is switched on.

Front courtesy light



central position	: automatic switching on and off
press 	: on
press 0	: off

Rear courtesy lights

Combi, Bus

Low level and overhead courtesy lights are located in the rear passenger compartment.



Press the button to switch the lights on or off.

Reading lights ⇨ 115.

Load compartment lighting

Load compartment lighting can be set to illuminate when the side and rear doors are opened, or switched on constantly.

With the switch in its central position, the light functions as a courtesy light.



- operated by pressing the left side of the switch: on constantly
- operated by pressing the right side of the switch: off constantly



Operated by pressing the switch :

- on constantly
- on when the doors are unlocked and opened
- off constantly

When the doors are closed, the courtesy light extinguishes after a delay or immediately after the ignition is switched on.

Reading lights

Front reading light



press  : on
 press **0** : off

Rear reading lights

Combi, Bus



Each reading light can be switched on or off individually and directed as required.

press **I** : on
 press **0** : off

Courtesy lights ⇨ 113.

Lighting features

Exit lighting



Headlights come on for approx. 30 seconds after the vehicle is parked and the system is activated.

Activating

1. Switch off ignition.
2. Light switch in position **0** or **AUTO**.
3. Pull lever towards steering wheel.

This action can be repeated up to four times.

The headlights are turned off immediately by turning the light switch to any position and returning to **O** or **AUTO**.

Battery discharge protection

To prevent discharge of the vehicle battery when the ignition is switched off, some interior lights may be switched off automatically after some time.

Infotainment system

Introduction	117
General information	117
Theft-deterrent feature	119
Control elements overview	121
Usage	128
Touch operation overview	135
Tone settings	136
Volume settings	137
System settings	138
Radio	143
Usage	143
Station search	144
Autostore lists	146
Radio data system (RDS)	147
Digital audio broadcasting	150
AUX input	150
General information	150
Usage	151
USB port	152
General information	152
Playing saved audio files	153
Bluetooth music	155
General information	155
Operation	155

External devices	160
Displaying pictures	160
Playing movies	161
Using smartphone applications	162
Navigation	163
General information	163
Usage	165
Destination input	176
Guidance	182
Symbols overview	189
Voice recognition	190
General information	190
Navigation control	191
Phone control	192
Phone	192
General information	192
Connection	194
Bluetooth connection	196
Emergency call	199
Operation	200
Mobile phones and CB radio equipment	206

Introduction

General information

The Infotainment system provides state-of-the-art in-car information and entertainment.

The radio is equipped with assignable channel presets for FM, AM and also DAB wavebands (depending on version).

External data storage devices, e.g. iPod, MP3 player or USB stick, or a portable player can be connected to the Infotainment system. External audio sources can also be connected via Bluetooth.

The digital sound processor provides several preset equalizer modes for sound optimisation.

The navigation system's dynamic route planning will reliably guide to the chosen destination and can help avoid traffic jams and other traffic problems.

Optionally, the Infotainment system can be operated using controls on the steering column or via the voice recognition system.

In addition, the Infotainment system can be equipped with a handsfree phone system.

The well-thought-out design of the controls and the clear displays enable to control the system easily and intuitively.

Notice

This manual describes all options and features available for the various Infotainment systems. Certain descriptions, including those for display and menu functions, may not apply to your vehicle due to model variant, country specifications, special equipment or accessories.

Important information on operation and traffic safety

Warning

Drive safely at all times when using the Infotainment system.

If in doubt, stop the vehicle before operating the Infotainment system.

Radio reception

Radio reception may be disrupted by static, noise, distortion or loss of reception due to:

- changes in distance from the transmitter
- multi-path reception due to reflection
- shadowing

In case of poor radio reception the volume will automatically drop as to minimize the disturbance effect.

Using this manual

- This manual describes features that may or may not be on your specific vehicle, either because they are optional or due to changes subsequent to the printing of this manual. Please refer to the purchase documentation to confirm each of the features found on the vehicle.
- Certain controls and descriptions, including symbols, displays and menu functions may not apply to your vehicle due to

model variant, country specifications, special equipment or accessories.

- The table of contents at the beginning of this manual and within each section shows where the information is located.
- The index will enable to search for specific information.
- The vehicle display screens may not support your specific language.
- Display messages and interior labelling are written in **bold** letters.
- The operations given within this manual refer to Infotainment system controls. For equivalent steering column controls, refer to the control elements overview ⇨ 121.

Warnings and cautions

⚠ Warning

Text marked **⚠ Warning** provides information on risk of accident or injury. Disregarding this information may lead to injury.

Caution

Text marked **Caution** provides information on possible damage to the vehicle. Disregarding this information may lead to vehicle damage.

Symbols

Page references are indicated with ↗.
↗ means "see page".

Theft-deterrent feature

Depending on Infotainment system, an electronic security system is included for the purpose of theft deterrence. The Infotainment system functions only in your vehicle and is therefore worthless to a thief.

The security code (supplied separately) must be entered upon first use of the system and after prolonged interruptions to the power supply.

Entering the security code

When first switching on the Infotainment system, an enter security code message, e.g. **Radio code** followed by **0000** appears on the display screen. Depending on Infotainment system, the message may only appear after a brief delay.

To enter first digit of security code, press numbered button **1** on the unit repeatedly until desired number is displayed. Enter second, third and fourth digits using buttons **2**, **3** and **4** in the same way.

When the full code is displayed, press and hold button **6** until an audible signal sounds. The system is unlocked when the correct code has been entered.

NAVI 50 IntelliLink,
NAVI 80 IntelliLink: Enter the security code using numbered buttons **0** to **9**

on the touchscreen display. The system is unlocked when the correct code has been entered.

Incorrect code entered

Depending on Infotainment system, when the security code has been entered incorrectly, an incorrect code message, e.g. **Error code** followed by a countdown value, e.g. **Wait 100** is displayed.

Wait until the countdown has expired, then enter the correct code. Each time the code is entered incorrectly, the countdown time may be doubled, depending on Infotainment system.

Changing the geographical area

When the security code is entered, depending on Infotainment system it will be necessary to choose a geographical area, for example:

- Europe
- Asia
- Arabia
- America

120 Infotainment system

Switch off the Infotainment system, then simultaneously press button **1** and **5** and \odot . Then press \blacktriangleleft or \blacktriangleright until desired area is highlighted on the display screen and set with button **6**.

Control elements overview



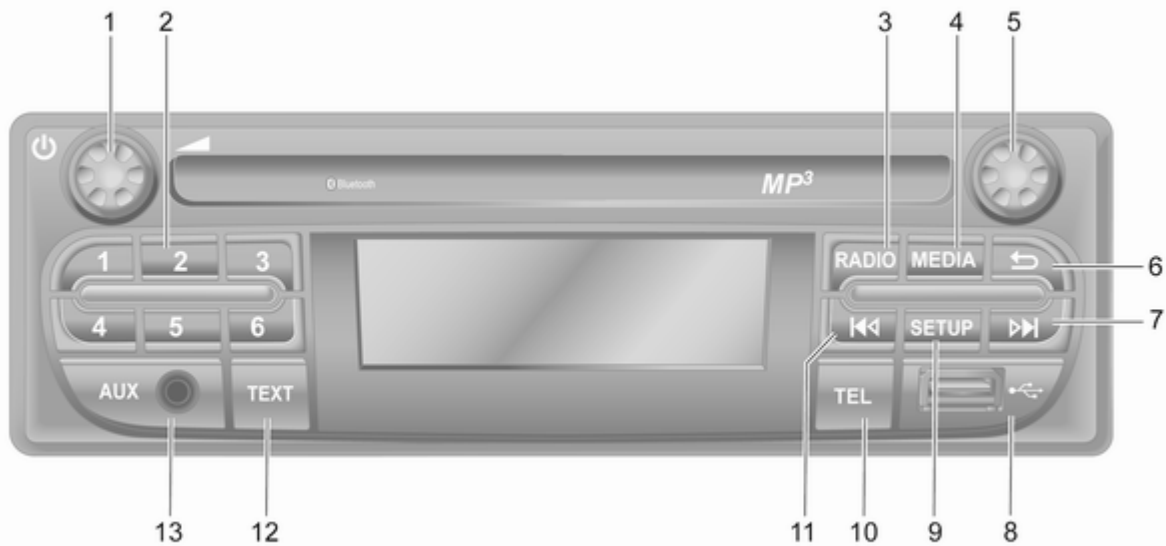



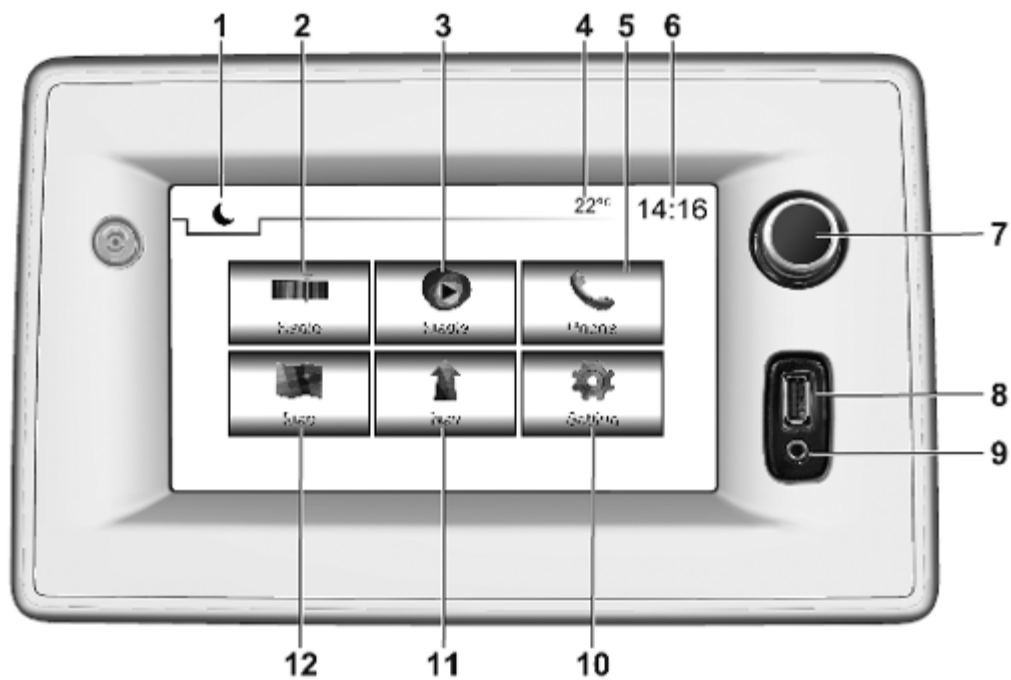

Radio 15 USB



- | | | | |
|---|---|----|---|
| 1 | ⏻ - Press: Switch on/off 128 | 10 | TEL - Telephone menu 192 |
| | Turn: Adjust volume 128 | 11 | ⏮ - Radio, Short press:
Search for previous radio
frequency 144 |
| 2 | Station buttons 1...6 144 | | Long press: Automatic
station search 144 |
| | Short press: Select station .. 144 | 12 | TEXT - Display radio text
information 147 |
| | Long press: Save station 144 | 13 | AUX input 150 |
| 3 | RADIO - Change audio
source, waveband 143 | | |
| 4 | MEDIA - Change audio
source 152 | | |
| 5 | Rotary knob 128 | | |
| | Short press: Confirm an
action 128 | | |
| | Turn: Access display
menu options 128 | | |
| 6 | ↩ - Return to previous
menu, cancel an action 128 | | |
| 7 | ⏭ - Radio, Short press:
Search for next radio
frequency 144 | | |
| | Long press: Automatic
station search 144 | | |
| 8 | ψ USB port 152 | | |
| 9 | SETUP - Short press:
Settings menu 128 | | |

NAVI 50 IntelliLink



- 1 : Darken screen (only clock and audio system information are displayed) . . 128
- 2  **Radio**: Change audio source to radio 143
- 3  **Media**: Change audio source - USB, iPod 152
 - BT (Bluetooth) 155
 - AUX 150
- 4 Outside temperature (depending on version) 128
- 5  **Phone**: Telephone menu . 192
- 6 Clock 128
- 7 : Switch on/off 128
 - Increase / decrease volume 128
- 8  USB port 152
- 9 AUX input 150
- 10  **Settings**: Audio settings, e.g. Tone settings 136
 - Volume settings 137
 - Connectivity settings 128
 - Display settings 128
 - System settings 138
- 11  **Nav**: Navigation menu 163
- 12  **Map**: Display the map 163

NAVI 80 IntelliLink

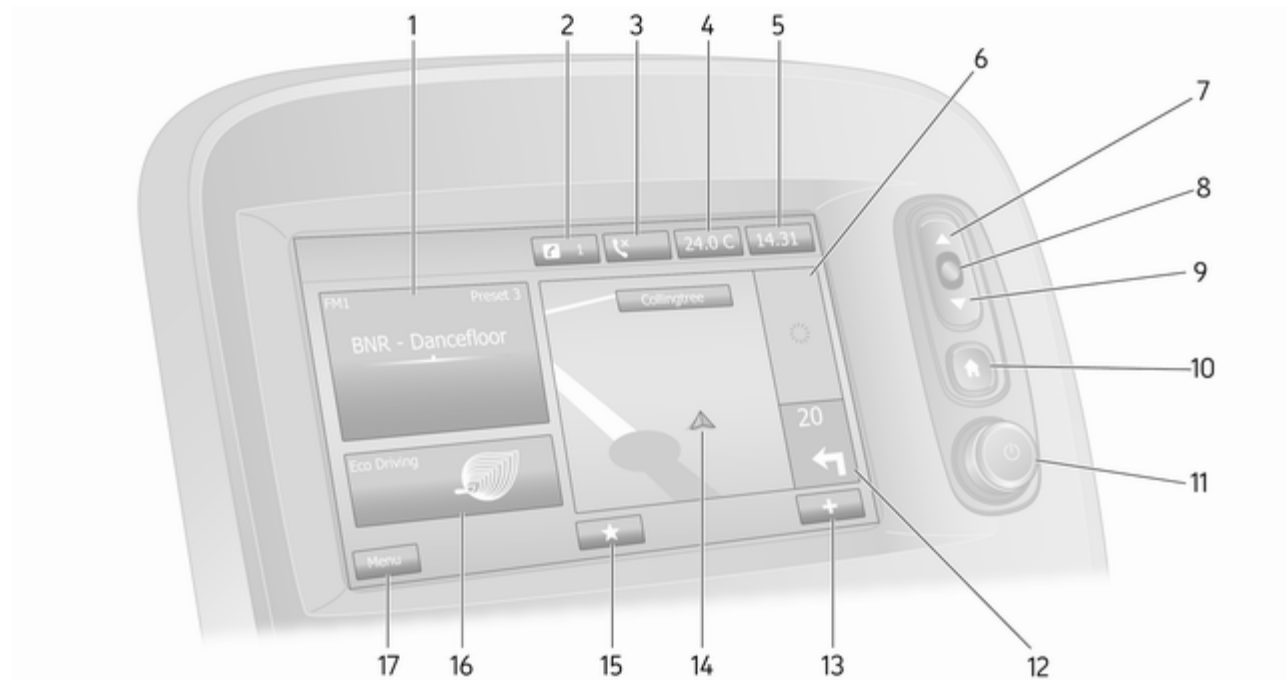



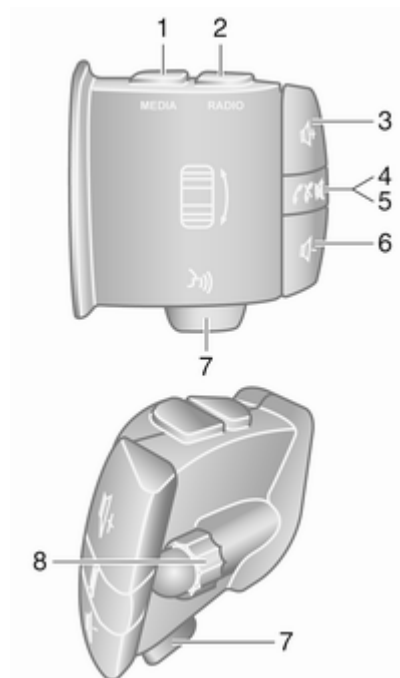

1	Audio information, e.g. Radio	143
	Auxiliary devices	150
	ψ USB devices	152
	Bluetooth music	155
2	ⓘ: System notifications (if equipped)	128
3	☎: Telephone status	192
	Call log	200
4	Outside temperature	128
5	Clock	128
6	Traffic information (if applicable)	182
7	▲: Display lists - Scroll up . .	128
	Map: Change scale	182
8	Enter menus, confirm actions	128
9	▼: Display lists - Scroll down	128
	Map: Change scale	182
10	🏠: Home page	128

11	⏻ - Press: Switch on/off	128
	Turn: Change volume	128
12	Navigation: Direction and distance to next change of direction	163
13	⊕: Pop-up menu	128
14	Navigation display	163
	Map	182
15	★: Favourites, e.g. for Navigation ↑	163
	Media 🎵 (e.g. Radio)	143
	Phone ☎	192
	Services 📁	165
16	Driving economy (Eco Driving)	128
17	Menu: Access Main menu . .	128





Steering column controls - Type A

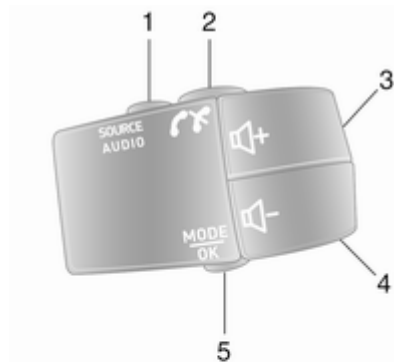

- 1 **MEDIA** - Change audio source 128
- 2 **RADIO** - Change radio waveband 143
- 3  - Increase volume 128
- 4  - Mute/unmute 128
- 5  - Take/end phone call .. 200
- 6  - Decrease volume 128
- 7  - Voice recognition 192
- 8 Turn: Move up/down in display menus, select next/previous radio preset / radio frequency / audio track 144
Press: Confirm actions 143

Steering column controls - Type B



- 1 **SOURCE/AUDIO** - Change audio source 128
- 2  192
Take/end phone call 200
-  - Mute/unmute 128
- 3  - Increase volume, mute/unmute 128
- 4  - Decrease volume, mute/unmute 128
- 5 **MODE/OK** - Confirm actions, change audio mode 143
Take/end phone call 200
- 6 Turn: Access display menu options, next/previous radio preset / radio frequency / audio track 143





Notice

If equipped, the voice recognition button  may be located on the steering column controls.

Usage**Infotainment controls**

The Infotainment system is operated via buttons, rotary knobs and/or display menus.

Inputs are made via:

- the central control unit in the instrument panel  121, or
- the controls on the steering column  121
- the voice recognition system (if available)  190
- the touchscreen (NAVI 50 IntelliLink, NAVI 80 IntelliLink)  135

Notice

Only the most direct ways for menu operation are described in the subsequent chapters. In some cases, there may be other options.

Switching the Infotainment system on or off

Press  to switch the Infotainment system on.

The previously used audio source is active.

Press  (or, depending on Infotainment system, press and hold) to switch the Infotainment system off.

Notice

The clock and/or outside temperature may be displayed when the Infotainment system is switched off (depending on version).

NAVI 50 IntelliLink:

The Infotainment system automatically switches on/off when the ignition is switched on/off. Press  instead, if required.

Press and hold  for 5 seconds to restart the system.

NAVI 80 IntelliLink:

The Infotainment system switches on automatically when the ignition is switched on (depending on version). Press  instead, if required.

The following options may be displayed (depending on version):

- **Change settings** (to authorise or reject data sharing)

The system displays a screen to confirm the authorisation of data sharing after touching **Change settings**.

Notice

When data sharing is switched off, certain features may not operate correctly.

- **Language** (to change the system language)
- **Done** (to continue to the Home page)
- **Help** (to see more detailed information)

The Infotainment system automatically switches off when the ignition is switched off and the driver's door is opened. Press  instead, if required.

Automatic switch-off

With the ignition off, if the Infotainment system is switched on with , it will switch-off automatically

a short period after the last user input. Depending on Infotainment system, automatic switch-off occurs after approx. 5 to 20 minutes.

Pressing \odot again will allow the Infotainment system to remain on for a further 5 to 20 minutes, depending on Infotainment system.

Setting the volume

Turn \odot / volume rotary knob.

Alternatively (with the steering column controls), press \leftarrow or \rightarrow .

NAVI 50 IntelliLink:

Depending on version, it is possible to set various volume levels individually (including audio players, traffic announcements, navigation instructions, phone calls and ringtone).

From the Home page, touch **Settings** then **Audio** followed by **Sound**.

Refer to (NAVI 50 IntelliLink) "Volume settings" \rightarrow 137.

NAVI 80 IntelliLink:

To set various volume levels individually (e.g. navigation instructions, traffic announcements, phone calls) from the Home page, touch **MENU** then **System** followed by **Sound**.

Refer to (NAVI 80 IntelliLink) "System settings" \rightarrow 138.

Stored volume

When the Infotainment system is switched off, the current volume is stored.

Speed dependent volume

When speed dependent volume (\rightarrow 138) is activated, the volume is adapted automatically to compensate for road and wind noise.

Mute

To mute the current audio source (depending on Infotainment system), press \odot briefly or turn knob fully anticlockwise.

Alternatively (with the steering column controls), press \times or \times or press \leftarrow and \rightarrow simultaneously.

Unmute

To unmute (depending on Infotainment system), briefly press \odot again or turn clockwise.

Alternatively (with the steering column controls): Press \times again or press \leftarrow and \rightarrow simultaneously again.

Notice

When a traffic announcement is broadcast, the system is automatically unmuted.

For further information, refer to "Radio data system" \rightarrow 147.







Display screen operation

Radio 15 USB

- To move up/down in the display: Turn **OK**.
- To confirm actions: Press **OK**.
- To cancel actions (and return to previous menu): Press \rightarrow .



NAVI 50 IntelliLink

Use the touchscreen for the following displayed menus as described in each section:

-  **Radio**
Refer to "Radio" section ⇨ 143.
-  **Media**
Refer to "USB port" section ⇨ 152.
-  **Phone**
Refer to "Phone" section ⇨ 192.
-  **Map**
Refer to "Navigation" section ⇨ 163.
-  **Nav**
Refer to "Navigation" section ⇨ 163.
-  **Settings**
Refer to (NAVI 50 IntelliLink) "Tone settings" ⇨ 136, "Volume settings" ⇨ 137 and "System settings" ⇨ 138.

Notice

Depending on software version, the menus available on the display screen may differ from those listed above.



When the Home page  is displayed, it is possible to hide these menus from the display (only clock and audio system information may be shown) by touching . Touch anywhere on the screen to display these menus again.

NAVI 80 IntelliLink

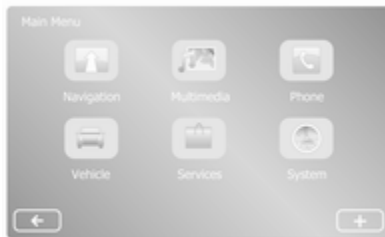
Use the touchscreen for the following displayed menus as described in each section.



On the Home page, touch **MENU** to access the Main menu. The following menus and controls are displayed:

-  **Navigation**
Refer to "Navigation" ⇨ 163.
-  **Multimedia:**
 - **Radio:** Refer to "Radio" ⇨ 143.
 - **Media:**
USB: Refer to "USB port" ⇨ 152.
Auxiliary: Refer to "AUX input" ⇨ 150.
Bluetooth: Refer to "Bluetooth music" ⇨ 155.
 - **Pictures:** Refer to "Displaying pictures" in the "External devices" section ⇨ 160.
 - **Video:** Refer to "Playing movies" in the "External devices" section ⇨ 160.
 - **Settings:** Refer to "Multimedia settings" in the (NAVI 80 IntelliLink) "System settings" section ⇨ 138

-  **Phone**

Refer to "Phone" ⇨ 192.

-  **Vehicle**

Touch to open Eco Driving, Onboard computer and Settings menus.

Refer to (NAVI 80 IntelliLink) "Modes of operation" below.

-  **Services**

Touch to open Navigation services and Settings menus.

Refer to (NAVI 80 IntelliLink) "Modes of operation" below.



-  **System**

Refer to (NAVI 80 IntelliLink) "System settings" ⇨ 138.

Notice

Depending on software version, the menus on the display screen may differ from the illustrations shown.

- □/←: Move to previous page
- >/→: Move to next page
- ↑: Display lists; Scroll up
- ↓: Display lists; Scroll down

- : Open pop-up menu
- : Return to previous menu

The display screen can also be operated using the controls on the Infotainment system fascia.

Notice

Depending on version, some controls available on the Infotainment system fascia do not operate the features on the display screen.

Notice



Depending on vehicle, operation of the touchscreen may be restricted during driving.

Modes of operation

Radio 15 USB:

To change the audio source to radio, press **RADIO**.

NAVI 50 IntelliLink:

To access the radio menu at any time, touch  followed by  **Radio**.

NAVI 80 IntelliLink:

To access the radio menu from the Home page, touch **MENU** then **Multimedia** followed by **Radio**.

Detailed description of the radio functions ⇨ 143.

Audio players

To change the audio source to **USB**, **AUX**, Bluetooth or iPod (where applicable), touch **MEDIA**.

NAVI 50 IntelliLink: To access the menu for connected auxiliary devices (**USB**, **iPod**, **BT** (Bluetooth), **Video** or **AUX**) at any time, touch  followed by  **Media**. Touch  in top left corner and select auxiliary source.

NAVI 80 IntelliLink: To access the menu for auxiliary devices (e.g. USB, AUX input, Bluetooth) from the Home page, touch **MENU** then **Multimedia** followed by **Media**. Select auxiliary source from the display list.

Radio 15 USB

Detailed descriptions of:

- AUX input functions ⇨ 151
- USB port functions ⇨ 152
- Bluetooth music operation ⇨ 155

NAVI 50 IntelliLink

Detailed descriptions of:

- AUX input functions ⇨ 151
- USB port (including iPod) functions ⇨ 152
- Bluetooth music operation ⇨ 155

NAVI 80 IntelliLink

Detailed descriptions of:

- AUX input functions ⇨ 151
- USB port functions ⇨ 152
- Bluetooth music operation ⇨ 155

Navigation, Map (NAVI 50 IntelliLink, NAVI 80 IntelliLink)

Detailed description of the navigation system ⇨ 163, Browse map ⇨ 182.

Phone

Use the display options in the following menus to connect mobile phones, make telephone calls, create contacts lists and adjust various settings.

Detailed description of the handsfree phone system functions ⇨ 192.

Radio 15 USB

To access the **Phone** menu: Press  or **TEL**.

To access the phone settings menu: Press **TEL** and select **Phone settings**.

NAVI 50 IntelliLink

To access the Phone menu at any time: Touch  followed by  **Phone**.

NAVI 80 IntelliLink

To access the Phone menu from the Home page, touch **MENU** followed by **Phone**.

Vehicle information

To access the Vehicle menu from the Home page, touch **MENU** followed by **Vehicle**.

Depending on vehicle, the following menus are displayed:

- **Eco Driving**
- **Onboard computer**
- **Settings**

Eco Driving

The following features are available:

- **Trip report**

Displays the following data from the last journey:

Average fuel consumption, average speed, total fuel consumption, total distance, etc.

Within the trip report, **Eco scoring** provides an overall score out of 100 for driving economy. Higher figures indicate better driving economy. Ratings are also given for average environmental driving performance (Acceleration), gearchanging efficiency (Gearbox) and brake control (Anticipation).

To save journey data: Touch 'Save' then select the journey type from the following list:

Home/work, holiday/vacation, weekend, trip/tour, personal.

To reset journey data: Touch 'Reset'. Confirm or cancel with 'Yes' or 'No'.

Touch  to open pop-up menu where trip reports can be compared or to show/hide reports after the completion of a journey.

- **My preferred trips**

Displays changes in driving style (when journey data has been saved).

The 'Summary' tab for each journey type (e.g. Home/work) displays the following: Total route distance, distance covered, date of information update and average driving economy rating out of 100.

The 'Detailed report'/'Details' tab displays journey record information.

- **Eco-coaching**

Displays advice for reducing fuel consumption.

Scroll through the pages and familiarise yourself with the advice.

Onboard computer

Displays the following information since the last reset:

- start date of calculation
- total distance
- average speed

- average fuel consumption
- total fuel consumption

To reset onboard computer and instrument panel trip computer information, touch **Reset** then **Yes** to confirm.

For further information, refer to "Trip computer" in the Owner's Manual.

Settings

The following settings can be changed:

- **Park assist**

- **Volume:**

Touch **+** or **-** alongside the volume bar to change volume of the ultrasonic parking assist system. For further information, refer to "Parking assist" in the Owner's Manual.

- **Rear camera view settings** (available depending on version):

Select to switch rear view camera on/off, change guidelines (static/dynamic) and adjust image settings

(e.g. brightness, colour and contrast).

Touch **Done** to save changes. For further information, refer to "Rear view camera" in the Owner's Manual.

- **+** (pop-up menu):

Touch **+** in the **Park Assist** menu or submenus followed by **Reset to the default values** to restore default factory settings for all or current park assist options.

- **Image settings** (available depending on version)

To adjust e.g., brightness, colour and contrast.

- The following options (depending on vehicle) can also be adjusted:

- Daytime running lights (switch on/off).
- Unlock the driver's door only when opening the door (switch on/off).
- Easy access (switch on/off).

- Driving style indicator (fuel economy gauge) (switch on/off).
- Eco score (switch on/off).
- Show report after trip (switch on/off).

After the settings are changed, touch **Done** to confirm.

Services (NAVI 80 IntelliLink)

To access the Services menu from the Home page, touch **MENU** followed by **Services**.

The following menus are displayed:

- **Navigation services**
- **Settings**

Navigation services

In addition to the navigation services (e.g. traffic information, fixed speed cameras), extra features can be added by subscribing to LIVE services.

Refer to (NAVI 80 IntelliLink) "LIVE services" in the "Navigation" section ⇨ 165.

Settings

The following menus are displayed:

- **Applications manager**
Select to manage Bluetooth auxiliary devices.

- **Navigation services**
Select to access navigation related features, e.g. traffic, speed cameras, local search, My TomTom LIVE, weather.

Refer to (NAVI 80 IntelliLink) "LIVE services" in the "Navigation" section ⇨ 165.

Notice

A compatible SD card must be inserted to access LIVE services.

- **Update applications**
Select to update current applications.
- **Data sharing settings**
Select to switch data sharing on/off.

Notice

When data sharing is switched off, certain features may not operate correctly.

Favourites (NAVI 80 IntelliLink)

When the Home page is displayed, touch **★** to view, add or delete favourites for the following features:

- **↑ Navigation** ⇨ 163.
- **📻 Multimedia** - refer to "Radio" ⇨ 143.
- **📞 Phone** ⇨ 192.
- **📺 Services** ⇨ 165.

Navigation favourites

Select an empty slot in the display or touch **+** (to open a pop-up menu), then select **Add Favourite**.

Choose from the displayed list to add a saved destination to the favourites.

For further information, refer to (NAVI 80 IntelliLink) "Destination input" in the "Navigation" section ⇨ 176.

Multimedia favourites

Select an empty slot in the display or touch **+** (to open a pop-up menu), then **Add Favourite**.

Choose from the displayed list to add a preset FM radio station to the favourites.

Phone favourites

Select an empty slot in the display or touch **+** (to open a pop-up menu), then **Add Favourite**.

Choose from the displayed list to add a phone contact to the favourites.

For further information, refer to (NAVI 80 IntelliLink) "Phonebook" in the "Phone" section ↗ 200.

Services favourites

Select an empty slot in the display or touch **+** (to open a pop-up menu), then **Add Favourite**.

Choose from the displayed list to add a service item to the favourites.

Delete favourites

Touch **+** and select **Remove all Favourites** or **Remove a Favourite**.

Then select a favourite from the displayed list. A confirmation message is displayed. Touch **Delete** and confirm if prompted.

Additional features (NAVI 50 IntelliLink)

Depending on version, rear camera view settings are available.

Rear camera view settings

When the rear camera view is shown on the display, touch **⚙** to open the settings menu.

The following settings can be updated:

- Switch the rear camera view display **Off/On**.
- Colours
Touch **←/→** to adjust level.
- Brightness
Touch **←/→** to adjust level.
- Contrast
Touch **←/→** to adjust level.

For further information, refer to "Rear view camera" section in the vehicle Owner's Manual.

Touch operation overview

The Infotainment system display (NAVI 50, NAVI 80 IntelliLink) has a touch-sensitive surface that allows direct interaction with the displayed menu controls.

Caution

Do not use pointed or hard items like ballpoint pens, pencils or similar for touchscreen operation.

Selecting or activating a screen button or menu item

Touch a screen button or menu item.

- A short touch activates the selected item.
- Touch and hold to save a selected item.

The corresponding system function is activated, a message is shown, or a submenu with further options is displayed.

Notice

In subsequent chapters, the operating steps for selecting and activating a screen button or menu item via the touch screen will be described as "...select <button name>/<item name>".

Scrolling lists

If there are more items available than presentable on the screen, the list must be scrolled.

To scroll through a list of menu items, touch ▼ or ▲ at the top and at the bottom of the scroll bar.

Touch and hold ▼ or ▲ to fast scroll through a list.

Notice

In subsequent chapters, the operating steps for scrolling to a list item via the touch screen will be described as "...scroll to <item name>".

Scrolling within a map

Touch anywhere on the map. The cursor indicates the current position. To scroll within the map, drag the map in the required direction.

Notice

Constant pressure must be applied and the finger must be moved at constant speed.

Pop-up menus

To open pop-up menus with additional options, touch +.

To exit a pop-up menu without accessing any options or making any changes, touch any part of the screen outside the pop-up menu.

Tone settings

Radio 15 USB

In the audio settings menu, the tone characteristics can be set.

Press **SETUP** to access the settings menu.

Select **Audio settings**, then **Sound** and turn **OK** until the desired setting is selected from:

- BASS (bass)
- TREBLE (treble)
- FADER (front/rear balance)
- BALANCE (left/right balance)

The display indicates the type of setting followed by the adjustment value.

Set the desired value by turning **OK** and press the knob to confirm selections.

To exit the audio settings menu, press →.

Notice

If there is no activity, the system will exit the audio settings menu automatically.

Setting bass and treble

Select **Bass** or **Treble**.

Set the desired value by turning **OK** and press the knob to confirm setting.

Depending on version, **BASS BOOST** setting is also available.

Setting the volume distribution between right - left

Select **Balance**.

Set the desired value by turning **OK** and press the knob to confirm setting.

Setting the volume distribution between front - rear

Available depending on version. Select **Fader**.

Set the desired value by turning **OK** and press the knob to confirm setting.

NAVI 50 IntelliLink

To access the settings menu at any time, touch  followed by  **Settings**.







The following settings submenus are displayed at the bottom of the screen:

- **Audio**
See "Audio settings" below.
- **Display**
Refer to (NAVI 50 IntelliLink) "System settings" ⇨ 138.
- **Connectivity**
Refer to (NAVI 50 IntelliLink) "System settings" ⇨ 138.
- **System**
Refer to (NAVI 50 IntelliLink) "System settings" ⇨ 138.

Audio settings

Select **Audio** to display the following options:

- **Vol/Speed** (Off/1/2/3/4/5)
Speed dependent volume control
- refer to (NAVI 50 IntelliLink) "Volume settings" ⇨ 137.

- **Loudness** (On/Off)
Switch loudness on to increase bass and treble levels.
- **BAL/FAD**
Depending on version, touch  to open the volume distribution balance and tone settings submenu.
On the left side of the display, adjust the right/left balance with / and the front/rear balance with / (if available).
On the right side of the display, adjust the **Bass**, **Mid** and **Treble** tone characteristics (between -5 to +5) with /.
- **Sound**
Touch **OK** to confirm changes.
- **Sound**
Sound settings (where volumes can be set individually for a list of audio types), refer to (NAVI 50 IntelliLink) "Volume settings" ⇨ 137.

NAVI 80 IntelliLink

Refer to (NAVI 80 IntelliLink) "System settings" ⇨ 138.

Volume settings

Radio 15 USB

Press **SETUP** to access the settings menu.

Select **Audio settings**, then **Speed vol.** and turn **OK** until the desired setting is selected.

NAVI 50 IntelliLink

To access the settings menu at any time, touch  followed by  **Settings**.

The following settings submenus are displayed:

- **Audio**
See "Audio settings" below.
- **Display**
Refer to (NAVI 50 IntelliLink) "System settings" ⇨ 138.
- **Connectivity**
Refer to (NAVI 50 IntelliLink) "System settings" ⇨ 138.
- **System**
Refer to (NAVI 50 IntelliLink) "System settings" ⇨ 138.

Audio settings

Select **Audio** to display the following options:

- **Vol/Speed** (Off/1/2/3/4/5)

The volume increases when vehicle speed increases, to compensate for wind and road noise.

Speed compensated volume can be switched off or the degree of volume adaptation can be set.

- **Loudness** (On/Off)

Switch loudness on to increase bass and treble levels.

- **BAL/FAD**

Refer to (NAVI 50 IntelliLink) "Tone settings" ⇨ 136.

- **Sound**

Touch ► to open the audio preferences submenu.

Depending on version, the volume of different audio types can be set independently, e.g. audio, traffic announcements (TA), navigation instructions, handsfree phone system and

ringtone levels. Touch —/+ to adjust volume of each audio type.

If required, touch **Reset** to return all volumes to the factory settings.

For other versions of the sound submenu, refer to (NAVI 50 IntelliLink) "Tone settings" ⇨ 136.

NAVI 80 IntelliLink

Refer to (NAVI 80 IntelliLink) "System settings" ⇨ 138.

System settings**Radio 15 USB**

Press **SETUP** and access the settings menu by turning and pressing **OK**.

When system setting adjustments have been made, press **SETUP** to exit the menu and save changes. The system also saves and exits automatically after a delay.

Set clock

To set the system clock and the time display format, select **Clock**. Select the required setting by turning and pressing **OK**.

Change system language

Change the display language by accessing the **Language** menu. Select a language from the list by turning and pressing **OK**.

Restore default system settings

To restore system settings to their default values, select **Default settings** by turning and pressing **OK**. Confirm modification when prompted by pressing **OK** again.

NAVI 50 IntelliLink

To access the settings menu at any time, touch ⌘ followed by ⚙ **Settings**.

The following settings submenus are displayed at the bottom of the screen:

- **Audio:**

Refer to (NAVI 50 IntelliLink) "Tone settings" ⇨ 136 and "Volume settings" ⇨ 137.

- **Display:** See below.

- **Connectivity:** See below.
- **System:** See below.

Display

Select **Display** to display the following options:

- **Brightness** (Low/Mid/High)
- **Map mode** (Auto/Day/Night)
 - **Auto:** Day and night mode are changed automatically.
 - **Day:** The map screen is always displayed with bright colours.
 - **Night:** The map screen is always displayed with dark colours.
- **Background** (Dark/Light)

Available depending on version. Switch between a dark or light display mode (available depending on vehicle).
- **Parking assistance**

Touch ► to open a submenu:

 - **Rear view camera** (On/Off)
 - **Obstacle detection**

Touch ► to open a submenu for activation or deactivation

of the front parking sensors and rear parking sensors.

Connectivity

Select **Connectivity** to display the following options:

- **View Bluetooth device list**
- **Search for Bluetooth device**
- **External device authorization**
- **Change passkey** (for pairing of Bluetooth devices with the Infotainment system)
- **Smartphone**

Available depending on version. For help with activating and operating voice controls - refer to "Voice recognition" ⇨ 190.

For further information on Bluetooth settings, refer to (NAVI 50 IntelliLink) "Bluetooth music" ⇨ 155 and "Bluetooth connection" in the "Phone" section ⇨ 196.

System

Select **System** to display the following options:

- **Language**

Change display language and voice instruction language for the navigation system. Press **OK** to confirm selection.
- **Clock/Units**

The following settings can be changed:

 - **Time Format** (12H/24H)
 - **Nav Units** (km/miles)
 - **Temperature** (°C/°F)
 - **Time Setting**

Press ► to open the **Time set** submenu containing the following options:

Auto/Manual

If Auto time setting is selected, the time is set automatically by GPS.

If Manual time setting is selected, adjust as appropriate.

Notice

Navigation maps for the current country must be installed on the system to ensure the local time is correct.

- **Factory settings**

The following settings can be reset to the factory default:

- **All**
- **Phone - Smartphone**
- **Navigation**
- **Audio-Media-Radio-System**
- **Navigation (On/Off)**
- **System version** (displays Infotainment system software version number)

When system setting adjustments have been made, touch  (and select another menu on the display) to exit the settings menu and save changes. The system also saves and exits automatically after a delay.

NAVI 80 IntelliLink

To access the system settings menu from the Home page, touch **MENU** followed by **System**.

The following settings submenus are displayed:

- **Language**
- **Display**
- **Sound**
- **Clock**
- **Safety warnings**
- **Home screen**
- **Keyboards**
- **Set units**
- **Status & Information**
- **Remove SD-card**
- **Restore factory settings**
- **Android Auto Settings™**

After system settings are changed, touch **Done** to confirm.

Language

To change Infotainment system language then voice type (depending on version).

Display

The following settings are displayed:

- **Daytime brightness:** Change screen brightness to suit external light levels (daylight).

During low external light levels, the display screen is easier to view when the display is not too bright.

- **Nighttime brightness/Night brightness:** Change screen brightness to suit external light levels (night light).

During low external light levels, the display screen is easier to view when the display is not too bright.

- **Automatic day/night mode/Change to night colours:** To activate automatic switching between daytime/night brightness.

Night mode is activated during low external light levels and when the headlights are switched on.

- **Force night mode/Use night colours:** To activate night mode.

Sound

The following settings submenus are displayed:

- **Sound levels:** To change volume and sounds for the main volume, handsfree phone system, phone ringtone, navigation instructions, system/computer voice, traffic information, and park assist (depending on version).
- **Alerts:** To adjust alert volume, and switch on/off alerts when display screen is switched off.
- **Speed sensitivity volume:** To set volume adjustment based on vehicle speed.
- **Voice output settings:** Adjust types of information to be given by the Infotainment system voice (e.g. "Read aloud motorway lane instructions").
- **Voice:** Change the voice used by the Infotainment system (if available).

Clock

To set the system clock and the time display format.

Keeping the automatic time adjustment setting switched on is recommended.

Safety warnings

To switch on/off various alerts provided by the Infotainment system (e.g. "Warn when driving faster than allowed"). Check appropriate boxes to switch on.

Home screen

To change the home page configuration.

Select from list of options to see a preview of each home page layout.

Keyboards

To change first the alphabet type (e.g. Latin, Greek) then the keyboard type (e.g. QWERTY, ABCD).

Set units

To change the units of measurement, for e.g. distance (km/miles), co-ordinates (degrees, minutes, seconds), temperature (°C, °F) and barometric units (if available).

Status & Information

To display system information, e.g. version, GPS status, network status, licences and copyright information.

Remove SD-card

To eject the SD card safely.

Restore factory settings

To delete all Infotainment system information. Follow the instructions on the display.

Notice

Afterwards, the Infotainment system will restart in English by default. If necessary, select **Language** in the **System** menu to change language.

Android Auto Settings™

To set the preferences for the "Android Auto™" application and access the instruction tutorial for the application on the Infotainment system.

Multimedia settings

To access the Multimedia settings menu from the Home page, touch **MENU** then **Multimedia**, followed by **Settings**.

The following settings submenus are displayed:

- **Sound**
- **Radio**
- **Media**

- **Pictures**
- **Video**

After settings have been changed, touch **Done** to confirm.

Sound

The following sound settings can be updated:

- 'Spatialisation':
Set the sound distribution in the vehicle.
- 'Bass Treble':
Set the sound option, e.g. 'Neutral' or 'Pop-rock', 'Classical', 'Jazz' (if available). Select 'Manual' to manually set the treble and bass levels.
Press **Done** to save changes.
- 'AGC Arkamys':
Equalise sound volume between two audio tracks.
- 'Bass Boost Arkamys':
Switch bass amplification on/off.

Radio

The following radio settings can be updated:

- switch searching for Alternative Frequencies (AF) on/off
- switch i-traffic (Traffic program information) on/off
- switch programme type (PTY) on/off
- switch simulcast on/off
- display i-announcement information (e.g. Area weather information, Event information)
- update list of saved radio stations

For further information, refer to (NAVI 80 IntelliLink) "Radio" ⇨ 143.

Media

The following media settings can be updated:

- switch Repeat (a track) on/off
- switch Shuffle on/off
- switch Display album cover on/off
- configure Manage Bluetooth devices

For further information, refer to (NAVI 80 IntelliLink) "Bluetooth music" ⇨ 155.

Pictures

The following photo settings can be updated:

- set display time for photos during a slideshow ("Slide show delay")
- switch from normal to full screen display ("Default view")

For further information, refer to "Displaying pictures" ⇨ 160.

Video

The following video settings can be updated:

- set display type for videos (if available)
- switch from normal to full screen display

For further information, refer to "Playing movies" ⇨ 161.

Radio

Usage

Radio reception

Radio reception may be disrupted by static, noise, distortion or loss of reception due to:

- changes in distance from the transmitter
- multi-path reception due to reflection
- shadowing

Radio 15 USB - Controls

The most important buttons for control of the radio are:

- **RADIO**: Activate radio, change waveband
- **◀▶**: Station search
- **OK**: Change frequency
- Station buttons 1...6: Preset station buttons

- **SETUP**: System settings, automatic station storing
- **TEXT**: Display radio text information

Activating the radio

Press **RADIO** to switch the audio source to radio.

The station previously selected will be received.

Selecting the waveband

Press **RADIO** repeatedly to switch between the available wavebands (e.g. FM1, FM2, AM).

The station previously selected in that waveband will be received.

NAVI 50 IntelliLink - Controls

Use the touchscreen to operate the radio.

The main controls are:

- **FM/AM/DAB** (depending on version): Switch between FM and AM wavebands.
- **◀◀/▶▶**: Start automatic search for next/previous radio station.

- **◀▶**: Change to next/previous frequency in increments of 0.5.
- **▲/▼**: Scroll through a list of stations.

Activating the radio

To activate the radio at any time, touch **📶** followed by **📻 Radio**. The station previously selected will be received.

The following submenus are displayed at the bottom of the screen:

- **Main**: Radio station/frequency is displayed.
- **List**: Displays an alphabetical list of available radio stations (maximum 50 stations).

Notice

Radio stations without RDS: Only the frequency is displayed. These stations appear at the end of the list.

- **Presets**: Displays stored favourite radio stations.
- **Options**:
The following settings can be changed, depending on selected waveband:

- **RDS** (On/Off)
- **TA** (On/Off)
- **Region** (On/Off)
- **News** (On/Off)
- **AM** (On/Off)
- **Update List** (Start)

For further information, refer to (NAVI 50 IntelliLink) "Radio data system (RDS)" ⇨ 147.

Selecting the waveband

Touch **▼** alongside **FM/AM/DAB** (if available) in the top left corner of the display and select FM, AM or DAB waveband.

The station previously selected in that waveband will be received.

Notice

AM waveband can be switched off via the **Options** menu.

Refer to "Digital audio broadcasting" ⇨ 150.

NAVI 80 IntelliLink - Controls

Use the touchscreen to operate the radio.

The main controls are:

- **FM/AM/DR**: Switch between FM, AM and DR (digital radio) wavebands.
- **⟨/⟩**: Start automatic search for next/previous radio station.
- **</>**: Change to next/previous frequency in increments.
- **↑/↓**: Scroll through a list of stations.

Activating the radio

To access the Radio from the Home page, touch **MENU** then **Multimedia**, followed by **Radio**.

The following modes are available:

- **Preset**:
Displays stored favourite radio stations.
- **List**:
Displays an alphabetical list of available radio stations (maximum 50 stations).

Notice

Radio stations without RDS: Only the frequency is displayed. These stations appear at the end of the list.

- **Frequency**:

Search manually or automatically by scanning the selected range of frequencies.

Selecting the waveband

Touch **FM/AM/DR** tab in top left corner of the display to switch between wavebands.

The station previously selected in that waveband will be received.

Station search

Automatic station search

Radio 15 USB

Briefly press **◀◀** or **▶▶** to search for the next receivable station in the current waveband.

If no station is found, automatic searching continues until **◀◀** or **▶▶** is pressed again.

NAVI 50 IntelliLink

Touch ◀◀ or ▶▶ to search for the next receivable station in the current waveband.

If no station is found, automatic searching continues until ◀◀ or ▶▶ is touched again.

NAVI 80 IntelliLink

Touch ◀ or ▶ to search for the next receivable station in the current waveband.

If no station is found, automatic searching continues until ◀ or ▶ is touched again.

Manual station search

Radio 15 USB

Select the desired waveband then press and hold ◀◀ or ▶▶ to scan the selected waveband.

Release the button when close to the required frequency. An automatic search is then made for the next receivable station and it is played automatically.

Turn **OK** to change the frequency in increments.

Stored station search

This allows to recall radio stations that have previously been stored.

To store a station, select the desired waveband and station then press station button 1...6 until an audible signal sounds, confirming that the station has been stored to the appropriate station button. Six stations per waveband can be stored.

Recalling a stored station

To recall a station, select the desired waveband then briefly press station button 1...6.

Search radio station name (FM only)

Select the FM waveband then highlight the station name in the display using ◀ or ▶.

Press $\frac{1}{2}$ or $\frac{1}{3}$ repeatedly to manually search for the required station name. The frequency may be displayed instead if the station name is unavailable.

The alphabetical list contains up to 60 FM radio stations with the best reception. This list can be updated at any time. Autostore lists ⇨ 146.

NAVI 50 IntelliLink

Select the desired waveband then touch ◀ or ▶ to change to next/previous frequency in increments of 0.5.

Stored station search

This allows to recall radio stations that have previously been stored.

To store a station, select the desired waveband and station then touch

Presets to display the stored favourites.

Touch and hold on the desired location. The frequency or name of the radio station appears on the favourite location, confirming that the station has been stored (📍 indicates the currently received station).

Notice

Twelve stations per waveband can be stored.

Recalling a stored station

To recall a station, select the desired waveband then touch **Presets** to display the stored favourites, then select the desired favourite radio station.

Touch ◀/▶ to move to the previous/next page of favourites.

Search radio station name (FM and DAB only)

Select waveband FM or DAB (if available) then touch **List** to display an alphabetical list of available radio stations.

Touch ▼ or ▲ to manually search for the required station name. The frequency may be displayed instead if the station name is unavailable.

Select a list item to receive the selected station (📶 indicates the currently received station).

The alphabetical list contains up to 50 radio stations with the best reception. This list can be updated at any time, refer to "Autostore lists" ⇨ 146.

NAVI 80 IntelliLink

Select the desired waveband then touch < or > to change to next/previous frequency in increments.

Stored station search

This allows to recall radio stations that have previously been stored.

To store a station, select the desired waveband and station then touch **Preset** to display the stored favourites.

Touch and hold on the desired location until a beep is heard. The frequency or name of the radio station appears on the favourite location, confirming that the station has been stored. Six stations per waveband can be stored.

Alternatively, select the desired waveband and station, then select **Frequency** or **List**. Touch **+** to open a pop-up menu, then select **Save as preset**. Touch and hold on the desired location until a beep is heard.

Recalling a stored station

To recall a station, select the desired waveband then touch **Preset** to display the stored favourites, then select the desired favourite radio station.

Search radio station name (FM only)

Select the FM waveband then touch **List** to display an alphabetical list of available radio stations.

Touch ↑ or ↓ to manually search for the required station name. The frequency may be displayed instead if the station name is unavailable.

The alphabetical list contains up to 50 radio stations with the best reception. This list can be updated at any time, refer to "Autostore lists" ⇨ 146.

Autostore lists

The stations with the best reception in a waveband can be searched for and stored automatically via the autostore function.

Automatic station storing

Radio 15 USB

The FM waveband has an autostore list (AST), on which six stations can be stored.

While listening to the radio, press and hold **RADIO**: The six stations with the strongest reception will be automatically stored on AST.

Notice

Due to signal strength, it is possible that less than six stations will be stored.

Recalling a station**Radio 15 USB**

Select the desired waveband, then briefly press station button 1...6 to recall a stored station.

To recall a station on the autostore list (AST), while listening to the radio briefly press **SETUP** to activate AST mode. The station previously selected will be received. Briefly press station button 1...6 to recall another stored station on the autostore list.

Updating stations list manually

Stations can also be stored manually in the autostore list.

Notice

Only available with NAVI 50 IntelliLink, NAVI 80 IntelliLink.

To update the list of stations and obtain the most recent ones, activate the system update manually. Depending on Infotainment system, the sound may be muted during a manual update.

NAVI 50 IntelliLink

Touch **Options**, scroll down to **Update List** then select **Start; Updating ...** appears on the display until the update is complete.

Notice

If DAB is available, it is recommended to update the DAB stations list manually when the system is switched on.

NAVI 80 IntelliLink

From the Home page, touch **MENU** then **Multimedia**, followed by **Settings**. Select **Radio** and scroll down to **Update radio list**.

Alternatively (depending on version), select **Multimedia** followed by **Radio**, and choose any the following modes:

- **Preset**
- **List**
- **Frequency**

Then touch **+** to open a pop-up menu, and select **Update radio list**.

Radio data system (RDS)

RDS is an FM station service that helps to find the desired station and ensures its fault-free reception.

Advantages of RDS

- The programme name of the chosen station appears on the display screen instead of its frequency.
- During an automatic station search, the Infotainment system tunes into RDS stations only.
- The Infotainment system always tunes into the best receivable broadcasting frequency of the chosen station, by means of AF (Alternative Frequency).

Radio 15 USB**Configuring RDS**

Press **SETUP** and turn **OK** to access the **RDS** menu. Press knob to select.

Turn the rotary knob to select **RDS SETUP**.

Switching RDS on and off

Press **Options** on the display screen. The following settings can be changed:

Switch on/off **RDS-AF** by pressing **OK**. **AF** is shown on the display screen when RDS is active.

Text information (Radio text)

Certain FM radio stations issue text information relating to the broadcast program (e.g. song name).

Press **SETUP** and turn **OK** to access the **Radio texts** menu.

Turn the rotary knob to select **Radio** and press the knob to see this information.

NAVI 50 IntelliLink

Configuring RDS

Select **Options**. The following settings can be changed:

- **RDS** (On/Off)
Switch off if not required.
- **TA** (On/Off)
See below.
- **Region/AF** (On/Off)
See below.
- **News** (On/Off)
See below.
- **AM** (On/Off)
Switch off if not required.
- **Update List** (Start)
Refer to (NAVI 50 IntelliLink) "Autostore lists" ↗ 146.

TA (Traffic announcements)

If **TA** is switched on:

- Traffic announcements from certain FM radio stations (and DAB stations, if available) are broadcast automatically.
- Radio and auxiliary audio source playback is interrupted for the duration of the traffic announcement.

Notice

Automatic broadcasting of traffic announcements is deactivated if waveband is set to **AM**.

Region/AF

If the RDS function is activated and **Region/AF** is switched on:

The frequency of certain FM radio stations may change depending on the geographical area.

News

If **News** is switched on:

- News announcements from certain FM radio stations (and DAB stations, if available) are broadcast automatically.
- Radio and auxiliary audio source playback is interrupted for the duration of the traffic announcement.

Text information (Radio text)

Certain FM radio stations (and DAB stations, if available) issue text information relating to the broadcast program (e.g. song name).

NAVI 80 IntelliLink

Configuring RDS

To access the Radio settings menu from the Home page, select **MENU** then **Multimedia**, followed by **Settings** then **Radio**.

Depending on version, touch **+** to open a pop-up menu, and access the 'Radio settings' option.

The following radio settings can be updated:

- switch searching for Alternative Frequencies (AF) on/off
- switch i-traffic (Traffic program information) on/off
- switch programme type (PTY) on/off
- switch simulcast on/off
- display i-announcement information (e.g. Area weather information, Event information)
- update list of saved radio stations

Alternative Frequency (AF)

Switch on the RDS-AF function to always tune into the best receivable broadcasting frequency of the chosen station.

i-traffic (Traffic program information)

Radio traffic service stations are FM RDS stations that broadcast traffic news.

Switch on I-Traffic to automatically receive traffic bulletins when they are broadcast.

Programme type search (PTY)

Switch on PTY to display the type of programme (e.g. news, sport) currently being broadcast

Update radio list

Refer to (NAVI 80 IntelliLink "Autostore lists" ⇨ 146.

Simulcast

Switch on the simulcast function to automatically change from a DR (digital radio) station to the same station on the FM waveband in the event of a loss of reception.

i-announcement

Select to display information such as weather or events in the vicinity.

Text information (Radio text)

Certain FM radio stations issue text information relating to the broadcast program (e.g. song name).

To check for text information, from any radio mode (e.g. **Preset**, **List**, **Frequency**) touch **+** to open a pop-up menu, and access the text information option, by selecting e.g. "Show radio text".

Digital audio broadcasting

Digital audio broadcasting (DAB) is an innovative and universal broadcast system.

General information

- DAB stations are indicated by the programme name instead of the broadcasting frequency.
- With DAB, several radio programmes (services) can be broadcast on a single frequency (ensemble).
- Besides high-quality digital audio services, DAB is also able to transmit programme-associated data and a multitude of other data services including travel and traffic information.
- As long as a given DAB receiver can pick up the signal sent out by a broadcasting station (even if the signal is very weak), sound reproduction is ensured.
- There is no fading (weakening of the sound) that is typical of AM or FM reception. The DAB signal is reproduced at a constant volume.

- Interference caused by stations that are on nearby frequencies (a phenomenon that is typical of AM and FM reception) does not occur with DAB.

If the DAB signal is too weak to be picked up by the receiver, the system switches over to the same programme on another DAB or FM station.

- If the DAB signal is reflected by natural obstacles or buildings, the reception quality of DAB is improved, whereas AM or FM reception is considerably impaired in such cases.
- When DAB reception is enabled, the FM tuner of the Infotainment system remains active in the background and continually searches for the best receivable FM stations.

AUX input

General information



Depending on version, in the Infotainment unit (or on the instrument panel) there is an AUX socket for the connection of external audio sources.

Notice

The socket must always be kept clean and dry.

It is possible, for example, to connect a portable CD player with a 3.5 mm jack plug to the AUX input.

Usage

An audio source that is connected to the AUX input can only be operated via the controls on the audio source, i.e. not via the Infotainment system. Only select a track directly on the audio source when the vehicle is stationary.

Caution

Before connecting or disconnecting an auxiliary device, e.g. a portable CD player, switch off the player and the Infotainment system, to avoid sound quality issues and possible damage to the equipment.

Upon connection via the jack plug, the system detects the audio source automatically. Depending on the recording volume, there may be a delay before the audio source is heard.

The artist or track name are not shown on the display screen.

Notice

Ensure the auxiliary device is securely stowed during driving. Vehicle occupants could be injured by objects being thrown around in the event of hard braking, a sudden change in direction or an accident.

Radio 15 USB

Press **MEDIA** to change the audio source to AUX mode, then switch on the auxiliary device. AUX appears on the display screen.



AUX settings

Press **SETUP** to access the settings menu.





Select AUX IN and turn **OK** until the desired setting is selected from:

- HI (300 mV)
- MID (600 mV)
- LO (1200 mV)

NAVI 50 IntelliLink

To access the media menu at any time, touch  followed by 
 **MEDIA**.

To switch between auxiliary sources, touch  in top left corner. The following options are available:

- **USB:** Refer to (NAVI 50 IntelliLink) "USB port"  152.
- **iPod:** Refer to (NAVI 50 IntelliLink) "USB port"  152.
- **BT:** Refer to (NAVI 50 IntelliLink) "Bluetooth music"  155.
- **Video:** Refer to (NAVI 50 IntelliLink) "Video"  161.
- **AUX:** Select to change the audio source to AUX mode, then switch on the auxiliary device.

NAVI 80 IntelliLink

Change the audio source to AUX mode to playback content from a connected auxiliary device.

To access the media menu from the Home page, touch **MENU** then **Multimedia**, followed by **Media**.

Touch **+** to open a pop-up menu (depending on version). The following options are available:

- **Auxiliary socket:** Change the audio source to AUX mode, then switch on the auxiliary device.
- **USB:** Refer to (NAVI 80 IntelliLink) "USB port" ⇨ 152.
- **Bluetooth connection:** Refer to (NAVI 80 IntelliLink) "Bluetooth music" ⇨ 155

USB port

General information



Depending on version, in the Infotainment unit (or on the instrument panel) there is a USB socket Ψ for the connection of external audio sources.

Notice

The socket must always be kept clean and dry.

An MP3 player, USB drive, iPod or smartphone can be connected to the USB port.

These devices are operated via the controls and menus of the Infotainment system.

Important information

MP3 player and USB drives

- The MP3 players and USB drives connected must comply with the USB Mass Storage Class specification (USB MSC).
- Only MP3 players and USB drives with a sector size of 512 Bytes and a cluster size smaller or equal to 32 kBytes in the FAT32 file system are supported.
- Hard disk drives (HDD) are not supported.
- The following restrictions apply for the data stored on an MP3 Player or USB device:
Only MP3 files, WMA and (depending on Infotainment system) ACC files can be read. WAV files and all other compressed files cannot be played.

Maximum folder structure depth: eleven levels.

Maximum number of files that can be saved: 1000 files.

NAVI 50 IntelliLink: Minimum recommended storage capacity of USB drive is 4 GB.

Recommended maximum storage capacity is 32 GB.

WMA files with Digital Rights Management (DRM) from online music shops may not play correctly or not at all.

Applicable playlist extensions: .m3u, .pls.

Playlist entries must be in the form of relative paths.

Playing saved audio files

Once connected, it is only possible to use the controls and menus of the Infotainment system to operate the audio device.

Radio 15 USB

MP3 player / iPod / USB drives

The system detects the audio device when a USB device is connected and the current track is displayed automatically.

When a new audio device is connected, the first track in the first folder is played automatically. When reconnecting the device, the previously played track is resumed.

Depending on the audio device connected, select a folder (MP3 player, USB drive) or a playlist (portable digital music player).

Selecting a track

To select tracks directly (and change folders), first access the audio device menu structure by pressing OK during playback. Select tracks and change folders by turning and pressing the knob.

NAVI 50 IntelliLink

MP3 player / USB drives / iPod

The system detects the audio device when a USB device is connected and the current track is displayed automatically. The device type (MP3 player/USB drive or iPod) is also recognised and the relevant audio source mode (USB or iPod) is selected automatically.

When the  MEDIA menu is active, the following submenus are available:

- **Main/Player**
- **List**
- **Options**

To switch between audio sources, touch ▼ in top left corner. The following options are available:

- **USB:** Select to change the audio source to USB mode.

Notice

During use, the battery of a connected USB device is charged or maintained.

- **iPod:** Select to change the audio source to iPod mode.
- **BT:** Refer to (NAVI 50 IntelliLink) "Playing music via Bluetooth" - ⇨ 155.
- **AUX:** Refer to (NAVI 50 IntelliLink) "Aux input usage" ⇨ 151.

Main/Player

Select to display the current track. In this display screen, the following options are available:

- ◀◀ (skip to previous track, press and hold to fast rewind)
- II/▶ (pause/play)
- ▶▶ (skip to next track, press and hold to fast forward)

List

Displays a list of the tracks in the current album/folder. Select a particular track to play it directly.

Notice

By default, albums are listed in alphabetical order.

If a USB drive is connected, all the folders will be at the same level on the tree structure.

To return to the previous level on the folder tree structure, touch ⬆.

Options

Select to display the following options:

- **Repeat** (Off/Track/Folder/All)
- **Shuffle** (On/Off)

NAVI 80 IntelliLink

MP3 player / USB drives

Change the audio source to USB mode to playback files from a connected USB device.

To access the media menu from the Home page, select **MENU** then **Multimedia**, followed by **Media**.

Touch **+** to open a pop-up menu (depending on version). The following options are available:

- **USB:** Change the audio source to USB mode.
- **Auxiliary socket:** Refer to (NAVI 80 IntelliLink) "AUX input" ⇨ 150.

- **Bluetooth connection:** Refer to (NAVI 80 IntelliLink) "Playing music via Bluetooth" ⇨ 155.

SD card

When USB mode is selected, the display includes the following options:

- ◀◀ or ▶▶: Move to previous/next track.
- II: Pause track.
- Scroll bar for time elapsed: Scroll through tracks.
- **New selection:** Choose another track from the connected audio source.
- **Current playlist:** Access the current playback list.
- ◀: Return to previous screen.
- **+**: Open pop-up menu; To change the audio source or access the track settings (e.g. switch on/off shuffle or repeat, show current track details, and access sound settings).

Disconnecting from USB socket

Playback is stopped immediately when the audio device is withdrawn from the USB socket.

Bluetooth music

General information

Bluetooth-enabled auxiliary audio sources (e.g. music mobile phones, MP3 players etc.) can be connected wirelessly to the Infotainment system.

Important information

- The Infotainment system only connects to Bluetooth devices that support A2DP (Advanced Audio Distribution Profile). Connection issues may arise with early versions.
- The Bluetooth device must support AVRCP (Audio Video Remote Control Profile) version 1.0 or higher. If the device does not support AVRCP, only the volume can be controlled via the Infotainment system.
- Before connecting the Bluetooth device to the Infotainment system, become acquainted with its operating instructions for Bluetooth functions.

Operation

Prerequisites

The following prerequisites must be met, in order to control a Bluetooth-enabled audio device via the Infotainment system:

- The Bluetooth function of the Infotainment system must be activated.
Refer to "Bluetooth connection" in the "Phone" section ↗ 196.
- The Bluetooth function of the Bluetooth-enabled auxiliary audio source must be activated (see audio device operating instructions).
- Dependent upon the audio source, it may be required to set that device to "visible" (see audio device operating instructions).
- The audio source must be paired and connected to the Infotainment system.

Radio 15 USB

Bluetooth connection

A connection must be set up between the audio device and the Infotainment system via Bluetooth, i.e. the device must be paired to the vehicle before using it.

Refer to "Bluetooth connection" in the "Phone" section ↪ 196.

- A maximum of five audio devices can be paired and saved in the device list, but only one can be connected at a time.
- If the device has both audio player and telephone functions, both functions will be paired. Pairing a mobile phone ↪ 194.
- Phone functions will remain active while the audio player is in use, and audio playback will be suspended during phone use.

Pairing an auxiliary audio device to the Infotainment system

To pair the audio device, press **TEL** and select **Pair device** by turning and pressing **OK**. The **Ready to Pair** screen is displayed.

Then, on the audio device, search for Bluetooth equipment in the vicinity of the device.

Select **My Radio** (i.e. the name of the system) from the list on the audio device, then, if applicable, on the audio device keypad enter the pairing code shown on the Infotainment system display screen.

Notice

If the audio device does not have a screen, enter the default pairing code on the device, then on the Infotainment system. Refer to the operating instructions for this default audio device pairing code, usually **0000**. Depending on the device, the pairing code may need to be entered in reverse order, i.e. on the Infotainment system first.

If pairing fails, the system returns to the previous menu and a corresponding message is displayed. Repeat procedure if necessary.

When pairing is completed, a confirmation message followed by the name of the paired audio device is shown on the Infotainment system display screen.

Notice

When a Bluetooth connection is active, controlling the audio device via the Infotainment system will discharge the audio device battery more rapidly.

Connecting an audio device

Audio devices are automatically connected to the Infotainment system after the pairing procedure is completed.

To connect any audio device that has been paired, or to connect to a different paired audio device than the current one, press **TEL** and select the **Select Device** menu. The device list shows the audio devices already paired.

Select the desired device from the list and confirm by pressing **OK**. A display message confirms connection.

Disconnecting an audio device

To disconnect an audio device from the Infotainment system, press **TEL** (or **SETUP**) and select **Bluetooth connection**. Select the desired device from the device list then select

Disconnect the device by turning and pressing **OK**. A display message confirms disconnection.

Switching off the audio device or deactivating the Bluetooth function on the audio device also disconnects the device from the Infotainment system.

Unpairing an auxiliary audio device from the Infotainment system

If the list of paired audio devices is full, a new device can only be paired if an existing device is unpaired.

To unpair, i.e. to delete an audio device from the system memory, press **TEL** and select **Delete device**. Select the desired audio device from the list and press **OK** to confirm deletion when prompted.

Operation via Infotainment system

When paired and connected wirelessly, audio playback begins automatically.

The audio device can then be operated via the Infotainment system function buttons, rotary knobs and display menus.

The range of accessible functions that can be operated via the Infotainment system depends on the type of audio player.

NAVI 50 IntelliLink

Bluetooth connection

A connection must be set up between the audio device and the Infotainment system via Bluetooth, i.e. the device must be paired to the vehicle before using it.

Refer to (NAVI 50 IntelliLink) "Bluetooth connection" in the "Phone" section ↗ 196.

- A maximum of five audio devices can be paired and saved in the device list, but only one can be connected at a time (depending on version, up to eight audio devices may be paired).

- If the device has both audio player and telephone functions, both functions will be paired. Pairing a mobile phone ↗ 194.
- Phone functions will remain active while the audio player is in use, and audio playback will be suspended during phone use.

Pairing an auxiliary audio device to the Infotainment system

To pair the audio device, touch  followed by  **Settings**.

Select **Connectivity** then either **Search for Bluetooth device** or **External device authorization**.

On the audio device, search for Bluetooth equipment in the vicinity of the device.

Select the name of the Infotainment system (e.g. **Media Nav Evolution**) from the list on the audio device, then (if required), on the audio device keypad, enter the pairing code shown on the Infotainment system display screen.

The default pairing code is **0000**. To change this pairing code before the pairing procedure is started, select **Change passkey** to update.

Notice

If the audio device does not have a screen, enter the default pairing code on the device, then on the Infotainment system. Refer to the operating instructions for this default audio device pairing code, usually **0000**. Depending on the device, the pairing code may need to be entered in reverse order, i.e. on the Infotainment system first.



If pairing fails, repeat procedure if necessary.

Notice

When a Bluetooth connection is active, controlling the audio device via the Infotainment system will discharge the audio device battery more rapidly.

Connecting an audio device

Audio devices are automatically connected to the Infotainment system after the pairing procedure is completed.

To change the audio device connected, touch  followed by  **Settings**.

Then select **Connectivity** followed by **View Bluetooth device list**. The device list shows the audio devices already paired.



Select the desired audio device from the list and confirm by touching **OK**.

Disconnecting an audio device

Switching off the audio device or deactivating the Bluetooth function on the audio device disconnects the device from the Infotainment system.

Unpairing an auxiliary audio device from the Infotainment system

If the list of paired audio devices is full, a new device can only be paired if an existing device is unpaired.

To unpair, i.e. to delete an audio device from the system memory, touch  followed by  **Settings**.

Select **Connectivity** then **View Bluetooth device list**.

Select the desired audio device from the list, then touch  to delete the device. If required, delete all devices

in the list by selecting **Options** followed by **Delete all**. Confirm with **OK**.

Operation via Infotainment system

When paired and connected wirelessly, audio playback begins automatically.

The audio device can then be operated via the Infotainment system display options.

The range of accessible functions that can be operated via the Infotainment system depends on the type of audio player.

The operation of the audio device when connected wirelessly is similar to the operations for playing saved audio files via the USB socket. Refer to (NAVI 50 IntelliLink) "Playing music via USB socket" in the "USB port" section ⇨ 153.

NAVI 80 IntelliLink

Bluetooth connection

A connection must be set up between the audio device and the Infotainment system via Bluetooth, i.e. the device must be paired to the vehicle before using it.

- There is a maximum number of audio devices that can be paired and saved in the device list, but only one can be connected at a time.
- If the device has both audio player and telephone functions, both functions will be paired. Pairing a mobile phone ⇨ 194.
- Phone functions will remain active while the audio player is in use, and audio playback will be suspended during phone use.

Pairing an auxiliary audio device to the Infotainment system

From the Home page, touch **MENU** then **Multimedia**, followed by **Settings**.

Select **Media** to access the media settings menu, then select the "Manage Bluetooth devices"/"Configure Bluetooth connection" option.

The pairing procedure is similar to pairing a mobile phone. Refer to (NAVI 80 IntelliLink) "Bluetooth connection" in the "Phone" section ⇨ 196.

Connecting an audio device

Audio devices are automatically connected to the Infotainment system after the pairing procedure is completed.

At any time, change the audio source to Bluetooth mode to playback files from a connected Bluetooth device.

From the Home page, select **MENU** then **Multimedia**, followed by **Media**.

Depending on version, touch **+** (to open a pop-up menu). Select **Bluetooth/Bluetooth connection** to change the audio source to Bluetooth.

Disconnecting an audio device

Switching off the audio device or deactivating the Bluetooth function on the audio device disconnects the device from the Infotainment system.

Unpairing an auxiliary audio device from the Infotainment system

To unpair, i.e. to delete a device from the system memory:

From the Home page, touch **MENU** then **Multimedia**, followed by **Settings**.

Select **Media** to access the media settings menu, then select the "Manage Bluetooth devices"/"Configure Bluetooth connection" option.

Press **+** to open a pop-up menu. The following options are available:

- **Disable Bluetooth:** Select to deactivate the Bluetooth function on the Infotainment system.
- **Set TomTom visible:** Select to make the Infotainment system "visible" to other Bluetooth devices, allowing them to be paired to the system.

- **Disconnect all devices:** Select to disconnect all currently connected devices from the Infotainment system without deleting/unpairing them.
- **Delete device(s):** Select to unpair a device from the Infotainment system.

The unpairing procedure is similar to unpairing a mobile phone. Refer to (NAVI 80 IntelliLink) "Bluetooth connection" in the "Phone" section ⇨ 196.

Operation via Infotainment system

When paired and connected wirelessly, audio playback may begin automatically.

The audio device can then be operated via the Infotainment system display options.

The range of accessible functions that can be operated via the Infotainment system depends on the type of audio player.

The operation of the audio device when connected wirelessly is similar to the operations for playing saved audio files via the USB socket. Refer

to (NAVI 80 IntelliLink) "Playing music via USB socket" in the "USB port" section ⇨ 153.

External devices

Displaying pictures

NAVI 80 IntelliLink

To access the "Pictures" menu from the Home page, touch **MENU** then **Multimedia**, followed by **Pictures**.

Notice

Playback is only possible when the vehicle is stationary.

Select the connected source device (e.g. USB) to access individual photos or present a slideshow of all compatible photos on the device.

The display includes the following options:

- < or >: Move to previous/next photo.
- **Thumbnails:** Switch between full screen and minimised view.
- **New selection:** Choose another photo from the connected source device.
- **+**: Open pop-up menu; To change the source device or access the photo settings.

When viewing a photo/slideshow, the pop-up menu also allows to set zoom level and display all photos in thumbnail form.

Photo settings - refer to (NAVI 80 IntelliLink) "System settings" ⇨ 138.

Playing movies

NAVI 50 IntelliLink

To access the "Video" menu from the Home page, touch **Media** and then **Video**.

Notice

Playback is only possible when the vehicle is stationary.

The following three tabs are available:

- **Player:** Display the video screen.
- **List:** Display a list of all available videos.
- **Options:** Display the playback settings and detailed video information.

The video screen includes the following options:

- Scroll bar for time elapsed: Scroll through videos.
- **◀:** Play video from the beginning / play previous video / fast rewind.
- **▶||:** Pause video.
- **▶I:** Play next video / fast forward.
- **☀:** Adjust the brightness. To continue the video playback, touch the screen.
- **⊕:** View the video in full screen.

NAVI 80 IntelliLink

To access the "Videos" menu from the Home page, touch **MENU** and then **Multimedia**, followed by **Video**.

Notice

Playback is only possible when the vehicle is stationary.

Select the connected source device (e.g. USB) to access individual or all compatible videos on the device.

The display includes the following options:

- **◀◀** or **▶▶:** Move to previous/next video.
- **||:** Pause video.
- Scroll bar for time elapsed: Scroll through videos.
- **New selection:** Choose another video from the connected source device.
- **Full screen:** Switch to full screen display.
- **←:** Return to previous screen.
- **⊕:** Open pop-up menu; To change the source device or access the video settings.

During video playback, the pop-up menu also allows to return to the list of videos.

Video settings - refer to (NAVI 80 IntelliLink) "System settings" ⇨ 138.

Using smartphone applications

The phone projection applications Apple CarPlay™ and Android™ Auto display selected apps from your smartphone on the display screen and allow their operation directly via the Infotainment controls.

Check with the device's manufacturer if this function is compatible with your smartphone and if this application is available in the country you are in.

Android Auto is available for NAVI 50 IntelliLink and NAVI 80 IntelliLink. Apple CarPlay is available for NAVI 50 IntelliLink.

Notice

While using navigation and music applications via phone projection, similar applications integrated in the Infotainment system will be replaced.

NAVI 50 IntelliLink

Preparing the smartphone

Android phone: Download the Android Auto app to the smartphone from the Google Play™ Store.

iPhone: Make sure Siri® is activated on the smartphone.

Connecting the mobile phone

Connect the smartphone to the USB port ⇨ 152.

Starting phone projection

Android phone: Touch the Android Auto button on the main screen of the Infotainment system and accept the requests on the smartphone in order to use the Android Auto app.

iPhone: Touch the CarPlay button on the main screen of the Infotainment system.

The phone projection screen displayed depends on the smartphone and software version.

To access a tutorial on smartphone connectivity, go to the **Settings** menu, select **Connectivity** and scroll through the list.

Returning to the home screen

Touch the home button.

NAVI 80 IntelliLink

Preparing the smartphone

Download the Android Auto app to the smartphone from the Google Play™ Store.

Activating phone projection

1. Connect the smartphone to the USB port ⇨ 152.
2. Accept the request on the display screen.
3. Touch ▲ on the display screen and accept the confidentiality clauses. As a first time user look out for system requests on the mobile device to continue.
4. Touch ▲ again.

Phone projection can now be used.

Using phone projection

- Touch ▲ on the display screen to access the Android Auto menu of the connected smartphone.
- Press and hold 3 on the steering column to access voice controls.

Returning to the display screen

Press .

Navigation

General information

Warning

The navigation system is an aid to your navigational abilities and does not replace them. Drive with due care and attention and adopt a safe, vigilant attitude.

If a navigation system instruction contradicts traffic regulations, the traffic regulations always apply.

The navigation system will reliably guide to the chosen destination without the need for physical road maps.

If the **Traffic info** service is available in your country or region, the current traffic situation is also considered in route calculations. The system receives traffic messages in the current reception area.

To receive the most up-to-date, real-time traffic information possible, subscribe to the Live services facility.

Notice

Only available with NAVI 80 IntelliLink.

Functioning of the navigation system

The position and movement of the vehicle are detected by the navigation system using sensors.

The distance travelled is determined by the vehicle's speedometer signal, and turning movements on bends are determined by a gyro sensor. The position is determined by GPS (Global Positioning System) satellites.

By comparing these sensor signals with the digital maps on the navigation system, it is possible to accurately determine the position of the vehicle.

When using the vehicle for the first time, or after a ferry trip, etc., the system will self-calibrate. It is, therefore, normal if it does not provide an exact location until the vehicle has travelled for some distance.

After the entry of the destination address or point of interest (nearest petrol station, hotel, etc.) the route is calculated from the current location to the selected destination.

Route guidance is provided by voice output and the display screen.

Warning

Areas such as one-way streets and pedestrian zones are not marked on the navigation system map. In such areas, the system may issue a warning that must be accepted. Therefore, pay particular attention to one-way streets and other roads and entrances that must not be driven into.

Notice

Depending on Infotainment system, radio reception may be interrupted during voice guidance and before each change of direction.

USB memory stick (NAVI 50 IntelliLink)

A USB memory stick is required for the navigation system, to contain, among other things, a digital map of the towns and roads in your country.

Notice

Use a USB memory stick, formatted to FAT32 format, with a minimum 4 GB and maximum 32 GB of storage capacity.

After driving the first 60 miles, it is possible to check for free digital map updates within a period of 90 days.

Notice

To avoid possible technical issues, only use a compatible USB memory stick for operating and updating the navigation system. Do not insert USB memory stick in any other device (e.g. digital camera, mobile phone, etc.), or in another vehicle.

Software installation

To update the digital maps and to benefit from exclusive downloadable services, an account must be created

on the vauxhall.naviextras.com website and the free software must be installed.

Creating an account

Create your internet account via the vauxhall.naviextras.com website. Select e.g., the "Register" option on the web page and enter the appropriate details.

Installing the software

Install the software on your computer by downloading from vauxhall.naviextras.com.

Follow the on-screen instructions to install the software and launch the online application.

Registering the navigation system

The navigation system must be registered with your new internet account.

Insert an empty USB memory stick in the navigation system's USB slot.

Touch  then select  **Nav**, followed by **Options** then **Map update**.

To ensure all content is saved in the navigation system's memory, select **Options** then **Update**. Wait for the update to complete before ejecting the USB memory stick.

Then insert the USB memory stick in your computer's USB slot while connected to the Internet. When the online application is launched and the USB memory stick is recognised, the system (or software) name appears in the application window. The navigation system is registered into your user profile.

After the initial set-up, the USB memory stick is automatically recognised by the navigation system and by the online application.

Updating the USB memory stick and navigation system

Updates are issued regularly, e.g. for map and safety camera revisions.

Notice

In certain countries it is illegal to download and activate the camera warning option and this could lead to prosecution.

These updates are only available via the online application catalogue, which is accessed via the USB memory stick.

Using the online application, it is possible to:

- update the navigation system (maps, safety cameras etc.)
- upgrade to premium POI content
- add or delete data
- customise the system

The online application menus guide you through these operations.

System update

To get the best from the navigation system, update it as often as possible.

To update the system, start the vehicle and do not switch off the engine while data is loading.

Insert the USB memory stick in the navigation system's USB slot. Available updates on the USB memory stick are recognised by the navigation system and the 'Update' screen is displayed automatically.

Select **Update** to begin installing the updates to the navigation system.

Notice

The navigation system may restart automatically during the update process.

Notice

Touch ← to go back to the previous screen.

Alternatively, touch 🏠 followed by

↑ **Nav**, **Options** then **Map update**.

Then select **Options** followed by **Update** to install updates to the navigation system.

Wait for the update to complete before performing any other operation or ejecting the USB memory stick.

SD card (NAVI 80 IntelliLink)

An SD card is supplied with the navigation system and contains, among other things, a digital map of the towns and roads in the country.

Consult a workshop to purchase a new SD card with updated digital map.

Notice

To avoid possible technical issues, only use a compatible SD card for operating the navigation system. Do not insert SD card in any other device (e.g. digital camera, mobile phone, etc.), or in another vehicle.

Usage

USB memory stick

NAVI 50 IntelliLink

Inserting the USB memory stick

Switch off the navigation system and insert the USB memory stick in the USB slot on the Infotainment system fascia. The USB memory stick is fragile; treat it with care.

Removing the USB memory stick

Switch off the navigation system and remove the USB memory stick from the USB slot on the Infotainment system fascia.

SD card

NAVI 80 IntelliLink Inserting the SD card



Switch off the Infotainment system and insert the SD card in its slot located on the instrument panel. The SD card is fragile; do not bend it.

Ensure the SD card is inserted the correct way. The orientation may differ, depending on location of the SD card slot in the vehicle.

Removing the SD card

To remove SD card from the Infotainment system, on the Home page touch **MENU**, then **System**

followed by **Remove SD card**; The SD card can now be ejected safely from its slot located on the instrument panel.

To remove the SD card from its slot, press on the card then release it. The card is released slightly to enable it to be withdrawn.

Notice

To avoid possible technical issues, only use a compatible SD card for operating and updating the navigation system. Do not insert SD card in any other device (e.g. digital camera, mobile phone, etc.), or in another vehicle.

Activating the navigation system

Switching on

The navigation system switches on automatically when the ignition is switched on. In other cases, press \odot .

With the ignition off, the navigation system can be used for upto 20 minutes. Press \odot to switch on the navigation system again. The system will automatically switch off upto 20 minutes after the last user input.

Switching off

With the ignition off, the navigation system switches off automatically when the driver's door is opened.

With the ignition on, press \odot to switch off the navigation system.

Switching between navigation system and Infotainment system menus

NAVI 50 IntelliLink

With the navigation system active, touch \uparrow or touch and hold \rightarrow/\leftarrow to return to the Infotainment system Home page.

NAVI 80 IntelliLink

With the navigation system active, touch \leftarrow (one or more times) to return to the Infotainment system Home page.

Information on the display

NAVI 50 IntelliLink

Menu screen

To access the navigation menu screen, touch \uparrow followed by \uparrow Nav.

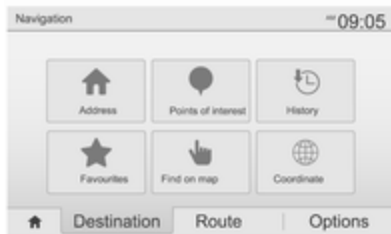

The navigation menu screen contains the following menus and submenus:

- **Destination**
Refer to (NAVI 50 IntelliLink) "Destination input" ⇨ 176.
 - **Address**
 - **Points of interest**
 - **History**
 - **Favourites**
 - **Find on map**
 - **Coordinate**
- **Route**
Refer to (NAVI 50 IntelliLink) "Route information" and "Edit

Itinerary" in the "Guidance" section ⇨ 182.

- **Create Route/Edit Route**
- **Avoidances**
- **Overview**
- **Cancel Route**
- **Alternative routes**
- **Route**
- **Options**

Refer to (NAVI 50 IntelliLink) "Setting up the navigation system" below.

- **Warnings**
- **Route settings**
- **Map settings**
- **Voice settings**
- **Coordinate format**
- **GPS**
- **Map Update**
- **Traffic**

Map screen

To access the map screen without route guidance, touch followed by (if available). Refer to (NAVI 50 IntelliLink) "Browse map" in the "Guidance" section ⇨ 182.

Touch anywhere on the map. The cursor indicates the current position. To scroll within the map, drag the map in the required direction. To return the cursor to the current vehicle position at any time, touch .

To access the map screen with route guidance, touch followed by and enter a destination. Refer to (NAVI 50 IntelliLink) "Destination input" ⇨ 176.

Touch anywhere on the map. The cursor indicates the current position. To scroll within the map, drag the map in the required direction.

The map screen (with or without route guidance) contains the following controls and information:

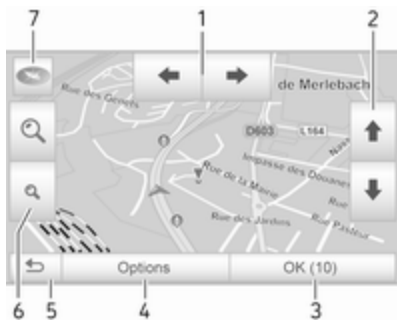

1. ◀/▶: Rotate map left/right
2. ↑/↓: Viewpoint (low/high view)
3. OK (with countdown timer): Confirm actions
4. Options menu (for route and map settings)
5. ↶: Return to previous screen
6. 🔍: Change scale (zoom in/out)
7. 🧭: Compass (touch to switch between '2D', '3D' and '2D North' map modes)



8. Name of the next major road or road sign information, if applicable
9. Current time
10. Direction and distance to next change of direction
11. Journey information, e.g. estimated arrival time, total remaining distance
12. Audio system information (touch to access audio source)
13. Route calculated and direction changes
14. ▲: Current location
15. Home page

16. 📡: Traffic information (TMC - Traffic Message Channel)

17. Speed limit



18. ⚙️: Settings pop-up menu (see items below)

19. 🔊/🔇: Voice guidance on/off

20. 🔍/🔍/🔍: Change scale (zoom in/out)

21. 🧭: Switch between '2D', '3D' and '2D North' map modes

Intersection view

During route guidance, before each change of direction a close-up view of the intersection is automatically

displayed. The normal view is resumed after passing the intersection.

Motorway view

During route guidance, before each motorway junction a 3D view of the junction is automatically displayed. The normal view is resumed after passing the junction.

Notice

For some motorway junctions, only a small turn arrow may appear on the map.

NAVI 80 IntelliLink Menu screen

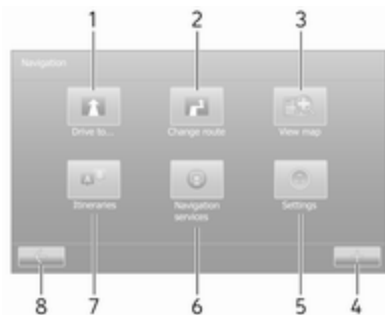

On the Home page, touch **MENU** followed by **Navigation** to access the navigation menu.

The navigation menu screen contains the following menus, submenus and controls:

1. DRIVE TO ...

Refer to (NAVI 80 IntelliLink) "Destination input" ⇨ 176.

- Home
- Saved locations
- Address
- Recent destinations
- Local search/TomTom places
- Point of Interest
- Point on map
- Latitude Longitude

2. CHANGE ROUTE

Refer to (NAVI 80 IntelliLink) "Edit Itinerary" in the "Guidance" section ⇨ 182.

- Calculate alternative
- Cancel route
- Travel via

- Avoid roadblock
- Avoid part of route
- Minimise delays

3. VIEW MAP

Refer to (NAVI 80 IntelliLink) "Browse map" in the "Guidance" section ⇨ 182.

- Use this location to...
- Find
- Change the map details
- Add to saved locations

4. +: Pop-up menu

5. SETTINGS

Refer to (NAVI 80 IntelliLink) "Setting up the navigation system" below.

- Turn off voice guidance
- Route planning
- Show POI on map
- Manage POIs
- Voice
- Set home location
- Manage saved locations
- Switch map

- Change map colours
- Car symbol
- Advanced

6. NAVIGATION SERVICES

Refer to (NAVI 80 IntelliLink) "LIVE services" below.

- Traffic
- Speed Cameras
- Local search/TomTom places
- My TomTom live
- Weather

7. ITINERARIES

Refer to (NAVI 80 IntelliLink) "Edit Itinerary" in the "Guidance" section ↷ 182.

- 8. ←: Return to previous screen

Map screen

To access the map screen without navigation, on the Home page touch **MENU**, then **Navigation** followed by **View Map**.

Touch anywhere on the map. The cursor indicates the current selected position. To scroll within the map, drag the cursor in the required direction.

To access the map screen with navigation, on the Home page touch **MENU** followed by **Navigation** and enter a destination. Refer to (NAVI 80 IntelliLink) "Destination input" ↷ 176.

The map screen (with or without route guidance) contains the following controls and information:

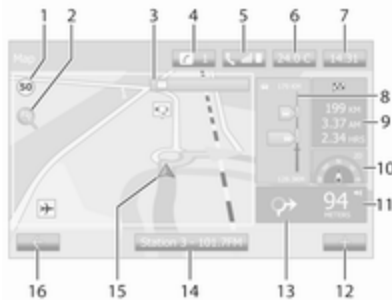

1. Speed limit (illuminates red and flashes if speed limit is exceeded)
2. ⌵: Change scale (zoom in/out)
3. Name of the next major road or road sign information, if applicable
4. ⓘ: System notifications (if equipped)
5. 📞: Phone information
6. Outside temperature
7. Clock
8. Live services: Traffic information (if applicable), e.g. route incidents, reception indicator, traffic map, speed camera locations (if available) and weather at destination.
9. Journey information, e.g. estimated arrival time, total remaining distance, journey status (green flag/red flag)
Route summary
10. Compass (touch to switch between 2D/3D map modes)
11. Change volume of guidance instructions

12. **+**: Pop-up menu
13. Direction and distance to next change of direction
14. Audio system information
15. **A**: Current location (cursor)
Route calculated and direction changes
16. **←**: Return to previous screen

Lane images

During route guidance, before each major road change, a 3D view of the junction (with a turn arrow and road signs) is automatically displayed. The normal view is resumed after passing the junction.

To switch off the lane images view, refer to (NAVI 80 IntelliLink "Advanced Settings" in "Setting up the navigation system" below.

Automatic zoom



During route guidance, before each change of direction a close-up view of the junction is automatically displayed. The normal view is resumed after passing the junction.

To switch off the automatic zoom feature, refer to (NAVI 80 IntelliLink "Advanced Settings" in "Setting up the navigation system" below.

Operating keyboards in the display

NAVI 50 IntelliLink

To move within and to enter characters in both the alphabetical and numerical keyboards, make the appropriate selection by touching the display screen.

- Select **Options** to change the keyboard type (e.g. QWERTY, ABC).
- Select **1^&** to switch to numbers and symbols.
- Select the drop down menu icon  to display a list of results for the current operation (e.g. destination input).
- Entries can be corrected during input with the  keyboard character.
- Touch **←** to stop using the keyboard and return to the previous screen.

Notice

When making an entry, certain letters and numbers are unavailable for selection (greyed-out) based on the information stored in the navigation system.

For further information, refer to "Touchscreen operation" ⇨ 135.

NAVI 80 IntelliLink

To move within and to enter characters in both the alphabetical and numerical keyboards, make the appropriate selection by touching the display screen.

- Entries can be corrected during input with the  keyboard character.
- Touch **←** to stop using the keyboard and return to the previous screen.

For further information, refer to "Touchscreen operation" ⇨ 135.

Live services

NAVI 80 IntelliLink

In addition to the navigation services (e.g. traffic information, fixed speed cameras), extra features can be added by subscribing to LIVE services.

LIVE services include up-to-date traffic information with "HD Traffic™", updates and locations of fixed and mobile speed cameras, local search, weather forecast and the "My TomTom LIVE" subscription status.

Notice

LIVE services are not available in some countries or regions.

The first owner of the vehicle has to activate this service within 14 days, otherwise this service is disabled. Touch **Activate my services** and then accept the displayed terms and conditions.

From the Home page, touch **MENU** then **Navigation**, followed by **Navigation Services**.

The following menus are displayed:

- **Traffic/HD Traffic**
Select to receive up-to-date, real-time traffic information.

Notice

The **HD Traffic** service is named **Traffic** if a subscription has not been activated.

- **Speed cameras**

Displays alerts and location of mobile speed cameras in real-time, fixed speed cameras and accident blackspots.

Switch function off via the "Speed Cameras" menu in "LIVE services", if required.

Report speed camera location, fixed or mobile.

Notice

In certain countries it is illegal to download and activate the camera warning option and this could lead to prosecution.

- **Local search/TomTom places**
This service allows you to use a keyword to quickly find any Point

of Interest (POI) and set it as a destination.



- **My TomTom LIVE**
Displays expiry date of subscribed services.

- **Weather**

The weather forecast service provides up to five days of weather reports for your current location and your chosen destination.

Setting up the navigation system

NAVI 50 IntelliLink

Touch  followed by NAVI / Nav then **Options**. This menu screen allows you to check and update the following map and navigation settings:

- **Warnings**
- **Route settings**
- **Map settings**
- **Voice settings**
- **Coordinate format**
- **GPS**

- **Map update**
- **Traffic** (depending on version)

Warnings

Select **Warnings** to access the following settings (switch off if not required):

- **Warn when speeding** (On/Off)
- **Speed limit always visible** (On/Off)
- **Alert point warnings** (On/Off)
- **Pre-alert distance** (0 m/200 m/500 m)

Available depending on version.

Warn when speeding: The digital map contains speed limits for certain roads. Audio and/or visual warnings are given when the vehicle exceeds the speed limit.

Speed limit always visible: The speed limit for certain roads is always visible on the screen.

Alert point warnings: When the vehicle passes an alert point (permanent or temporary) - i.e. when entering a hazardous section of road requiring extra caution, or nearing a

speed camera location (depending on country) - audio and visual warnings are given.

Pre-alert distance: Select a distance from which notifications of alert point warnings should be given.

Notice

Warnings may not be available for some roads and regions.

Route settings

Select **Route settings** to update the following settings for route calculation:

- **Route planning method** (Fast/Short/ECO)
- **Motorways** (On/Off)
- **Period charge** (On/Off)
- **Per-use toll** (On/Off)
- **Ferries** (On/Off)
- **Carpool/HOV** (On/Off)
- **Unpaved roads** (On/Off)
- **Permits needed** (On/Off) (depending on version)

If necessary, touch **Options** then **Reset to defaults** to set each of these options back to the factory default settings.

Alternatively, when the map is displayed (no route guidance is active), the **Route settings** menu can be accessed by touching **Options**.

Refer to (NAVI 50 IntelliLink) "Information on the display", "Map screen" above for further information.

Route planning method: Select **Fast** to set the fastest route to the destination entered. This method assumes the vehicle travels at or near the speed limit on all roads.

Select **Short** to set the shortest route and minimise the total distance to travel to the destination entered.

Select **Eco** to set a compromise between the fastest and the shortest route planning methods. The route provided may be shorter than the fastest method, but not significantly slower.

Motorways: To include or exclude motorways from the route plan.

Turn off, e.g. when towing a vehicle, or when motorway driving is not permitted.

Notice

Follow the regulations of the country in which you are driving.

Period charge: To include or exclude roads which require a special license to be purchased for certain periods.

Per-use toll: To include or exclude roads for which a toll must be paid to use the road once only.

Ferries: To include or exclude the use of ferries, ships and trains.

Carpool/HOV: To include or exclude carpool lanes and high-occupancy vehicle (HOV) lanes.

Unpaved roads: To include or exclude the use of unpaved roads, e.g. dirt, gravel roads.

Map settings

Select **Map settings** to access the following:

- **View mode** (3D/2D/2D North)
2D North is available depending on version.
- **Viewpoint** (Low/Normal/High)

- **Motorway view** (On/Off)
- **POI markers**

Alternatively, when the map is displayed (no route guidance is active), the **Map settings** menu can be accessed by touching **Options**.

Refer to (NAVI 50 IntelliLink) "Information on the display", "Map screen" above for further information.

View mode: Select **View mode** to change the default map mode between a 2D top-down view, a 3D perspective view and a 2D view with North always facing upwards.

Alternatively, touch the Compass on the map to switch between map view modes.

Viewpoint: Select **Viewpoint** to raise or lower the map view.

Alternatively, when the map is displayed (no route guidance is active), touch \uparrow/\downarrow to raise or lower the map view. They are greyed-out when the maximum position is reached.

Motorway view: Select **Motorway view** to switch on/off the motorway junction view for route guidance.

Refer to (NAVI 50 IntelliLink) "Information on the display", "Map screen" above for further information.

POI markers: Select **▶** alongside **POI markers** to display a list of Points of Interest (POI) types.

Use this screen to switch on/off (show or hide on map) certain POI type markers on the map, e.g. accommodation, airport, café or bar.

Select a POI type to open a list of its subcategories and switch on/off (show or hide) individual subcategories.

Notice

POIs are only visible on the map depending on the zoom level.

Voice settings

Select **Voice Settings** to change voice guidance language.

Scroll the list of languages by touching **▲/▼** then select a language and touch **OK** to confirm selection.

Coordinate format

Select **Coordinate format** to change the format of co-ordinate entries to one of the following options:

- DD.DDDDD
- DD MM.MMM
- DD MM SS.S

GPS

Select **GPS** to view the GPS information, e.g. available satellites, their location and signal strength.

Map update

Select **Map update** to display the following digital map content and latest update information:

- **Alert Points**
- **Junction View**
- **Maps**
- **Places**
- **Traffic Service**
- **Address Points**

Specific content or all map content can be updated. Select one of the options first or touch **Options** then **Update**. Wait for the update to complete.

Refer to "USB memory stick" (NAVI 50 IntelliLink), "Updating the USB memory stick and navigation system" in the "General information" section ↻ 163.

Traffic

Select **Traffic** to change the following traffic information settings:

- **Traffic info** (On/Off)
- **Detour**
- **Event types**

Traffic info: Warnings are given for incidents that occur along the route.

Detour: Save time by using an alternative route when a traffic jam or an incident occurs along the current route. Select 'On'/'Off' alongside "Confirm offered route?" as required.

If necessary, update the time value for the option "Offer detour if the calculated route saves more than:" (e.g. five minutes) by touching ◀/▶.

Event types: Select the type of events to be displayed during route guidance, e.g. all events, traffic flow events, closures and blockages, accidents.

NAVI 80 IntelliLink

To access the navigation settings menu from the Home page, touch **MENU** then **Navigation**, followed by **Settings**. The following settings submenus are displayed:



- **Turn off voice guidance:**
Switch on/off voice guidance during navigation.
- **Route planning:**
Settings for route type, toll roads, ferries, route summary, carpool lanes and unpaved roads.
Select a planning preference type; "Fastest route" is recommended. The eco-route is designed to save the most fuel.
Then switch on/off "iQ routes™" as required. iQ routes™ enables routes to be calculated according to average traffic levels during a particular day and time, and also the best route according to actual traffic speeds.
- **Show POI on map:**
Show or hide categories of POI markers on the map.

- **Manage POIs:**
Add, change or delete POIs or POI categories.
- **Voice** (depending on version):
Select synthesised voice or a male or female human voice (for the voice instructions) from the available list.
Human voices provide more simplified voice guidance instructions and are not available when using the Voice recognition function ⇨ 190.
- **Set home location:**
Change the home or most used destination address.
- **Manage saved locations:**
Delete or rename saved destination addresses.
To rename, select an address from the displayed list, select **Rename** then enter a new name. Touch **Done** to confirm. To delete a selected address, touch **Delete** and confirm when prompted.
- **Switch map:**
If more than one map is installed on the SD card, use this option to switch between the saved maps. Select "Change map" then choose the desired map from the options available.
- **Change map colours:**
Change day and night colours used on navigation map.
For downloaded new colours; choose a new colour, select additional colour scheme, then choose the desired colour from the options available.
- **Car symbol:**
Change the vehicle icon used on the 3D navigation map.
- **Advanced:**
Select from the following advanced options:
 - **Map information:**
Show/hide information displayed on the map, e.g. address number before street name, street names/ current street name, name of street after current street.
- **Map behaviour:**
Change how the map operates with the following options:
Show lane images (e.g. at motorway junctions), rotate map with vehicle direction (2D mode only), switch to 3D mode automatically during guidance, zoom automatically (2D mode, 3D mode).
- **Traffic source:**
Choose a traffic information source from the available list.

Destination input

NAVI 50 IntelliLink

Select a destination

Touch  followed by  **Nav** then **Destination**.

The following menu options are available for entering a destination:

- **Address**
Enter an address using the keyboard.
- **Points of Interest**
Select Points of Interest (POI), e.g. petrol station, restaurant, parking.
- **History**
Select from a list of previous destinations.
- **Favourites**
Select from a saved list of favourite destinations.
- **Find on map**
Select a destination by using the digital map.
- **Coordinate**
Enter the co-ordinates of the destination.

After a destination has been entered, wait for the ten second countdown to expire or touch **OK** to begin route guidance immediately.

Enter an address

Select **Address** and enter part or all of an address, e.g.:

- **Country**
- **Town or Postcode**
- **Street**
- **Number**
- **Intersecting street**

Notice

Full addresses can only be entered if they are recognised by the navigation system.

When entering an address for the first time, touch **Country**, then use the keyboard to enter the name of the country required. Alternatively, use the drop down menu icon  and select from a list of suggested countries.

Notice

When entering an address, certain letters and numbers are unavailable for selection (greyed-out) based on the addresses recognised by the navigation system.

Proceed in the same way to enter details for **Town or Postcode**, **Street**, **Number** and **Intersecting street**.

Notice

If a **Postcode** consists of several parts, insert a space after the first part of the postcode.

The address is automatically stored in the memory, available for future selection.

For keyboard operation, refer to (NAVI 50 IntelliLink) "Operating keyboards in the display" in the "Usage" section ↻ 165.

Notice

Number and **Intersecting Street** are only available after a **Street** has been entered.

When entering a **Street**, it is not necessary to specify the type of road (street, avenue, boulevard etc.).

Select Points of Interest (POI)

POIs can be selected as a destination using the following search options:

- preset POI list
- POI categories
- quick search for POIs via the map

Preset POI list

Select **Points of Interest** to choose from the frequently-used preset categories list (e.g. petrol station, parking, restaurant).

POI categories

Select **Points of Interest** followed by **Custom Search** to select from the list of categories and subcategories.

The search for POIs differs depending on the current situation:

- If route guidance is active, **Petrol station** and **Restaurant** POIs are searched for along the route, and **Parking** POIs are searched for around the destination.
- If there is no active route guidance, POIs are searched for around the current position.
- If the current position is not available (i.e. no GPS signal), POIs are searched for around the last known position.

The following options are available:

- **In a Town**
To search for a POI within a selected town (the resulting list is

ordered by distance from the town centre).

- **Along Route**

To search for a POI along the current route (the resulting list is ordered by length of the required detour).

- **Around My Position**

To search for a POI around the current position (the resulting list is ordered by distance from this position).

- **Around Destination**

To search for a POI around the destination of the current route (the resulting list is ordered by distance from the destination).

When a list of POIs is displayed, they can be sorted or displayed on the map. Touch **Options** to display the following:

- **Sort by name**
- **Sort by distance**
- **Sort by detour** (if route guidance is active)
- **Show all on map**

Quick search for POIs

Touch anywhere on the map. The cursor indicates the current selected position. To scroll within the map, drag the cursor in the required direction.

Touch **Options** followed by **Points of Interest Around Cursor** to show nearby POI names and their distance from the selected position on the map.

Alternatively, touch **Find** and use the keyboard to search for a destination by name.

Select from previous destinations list

Select **History** to access a list of previously entered destinations.

To sort the list, touch **Options** to display the following:

- **Sort by name**
- **Sort by distance**
- **Delete all**

Alternatively, touch **Find** and use the keyboard to search for a destination by name.

Select from Favourites list

Select **Favourites** to access a list of saved favourite destinations.

When the list of favourites is displayed, they can be sorted or displayed on the map. Touch **Options** to display the following:

- **Sort by name**
- **Sort by distance**
- **Show all on map**
- **Delete all**

Alternatively, touch **Find** and use the keyboard to search for a favourite by name.

Select a destination by using the map

Select **Find on Map** to begin a search for a destination by scrolling the map.

Touch anywhere on the map. The cursor indicates the current selected position. To scroll within the map, drag the cursor in the required direction.

Touch **OK** to select the position as a destination.

Enter the co-ordinates of the destination

Select **Coordinate** to begin a search for a destination by entering its co-ordinates.

To change the format of the co-ordinates, touch **Options** and select from the following:

- **Latitude/Longitude**

Values can be entered in any of the following formats:

- decimal degrees
- degrees and decimal minutes
- degrees, minutes and decimal seconds
- **UTM** (Universal Transverse Mercator)

Confirm the destination

When a destination has been selected, the route appears on the map. Touch **OK** and set as a **New route**.

If route guidance is active, the destination can be set as a **Waypoint** along the route.

Add and save a favourite

When a destination has been selected, touch **Options** to display the following:

- **Add to Favourites:** Save the destination in the favourites list.
- **Current traffic:** Provides information on traffic incidents (depending on version).
Refer to (NAVI 50 IntelliLink) "Traffic information" in the "Guidance" section ↻ 182.
- **Info/News:** Displays information (e.g. address) for the selected POI.
Shows the location (address) of the position selected, provides the GPS coordinates (latitude/longitude) and also, if applicable, displays the phone number of a selected POI.
- **Back to car:** Return to current vehicle location.

Before saving a favourite, the name of the favourite can be changed by using the keyboard.

For keyboard operation, refer to (NAVI 50 IntelliLink) "Operating keyboards in the display" in the "Usage" section ⇨ 165.

Delete a favourite

When a favourite has been selected, touch **Options** before starting route guidance followed by **Delete Favourite** and confirm deletion.

To delete all favourite destinations, select the menu **Destination Favourites** followed by **Options** then **Delete all** and confirm deletion.

NAVI 80 IntelliLink

Select a destination

From the Home page, touch **MENU** then **Navigation** followed by **Drive to....**

Select a destination from the following options on the display:

- **Home**
- **Saved locations**
- **Address**
- **Recent destinations**
- **Local search/TomTom places**

- **Point of Interest**
- **Point on Map**
- **Latitude Longitude**

Home

Guides to the home address.

To store the home address, from the Home page, touch **MENU** then **Navigation**, followed by **Settings**.

Select **Set home location** and enter an address.

Refer to (NAVI 80 IntelliLink) "Setting up the navigation system" in the "Usage" section ⇨ 165.

Saved locations

Select from a list of previously saved destinations.

To delete or rename saved destinations, from the Home page, touch **MENU** then **Navigation**, followed by **Settings**.

Then select **Manage saved locations** and update the selected destination as required.

Refer to (NAVI 80 IntelliLink) "Setting up the navigation system" in the "Usage" section ⇨ 165.

Address

Enter part or all of an address using the keyboard, e.g.:

- **Country**
- **Postcode**
- **Town/City**
- **Street**
- **House number**

Notice

Full addresses can only be entered if they are recognised by the navigation system.

When entering an address for the first time, the country of the destination will be requested. Use the keyboard to enter the name of the country required.

Suggestions may be shown on the display during input. Touch to select a destination shown in the display, or touch **List** to access the full list for the current part of the address.

Notice

When entering an address, certain letters and numbers are unavailable for selection (greyed-out) based on the addresses recognised by the navigation system.

Proceed in the same way to enter a **Postcode** or enter details for **Town/City, Street and Number**.

Notice

If a **Postcode** consists of several parts, insert a space after the first part of the postcode.

The address is automatically stored in the memory, available for future selection.

For keyboard operation, refer to (NAVI 80 IntelliLink) "Operating keyboards in the display" in the "Usage" section ⇨ 165.

Recent destinations

Select from a list of previous destinations that have been automatically stored.

Local search/TomTom places

Select a nearby Point of Interest (POI) by entering key words using the keyboard.

Notice

This feature is only available by subscribing to LIVE services.

For further information, refer to (NAVI 80 IntelliLink) "LIVE services" in the "Usage" section ⇨ 165.

Point of Interest

POIs can be selected as a destination using the following search options:

- **POI categories:**
Select a POI category type (e.g. petrol station, restaurant, parking), then select a search area (e.g. **POI nearby, POI in town, POI at home**).
Enter a town/city name and touch **Done** to confirm selection.
- **POI names:**
Enter name of a POI and select to begin a search.

Point on Map

Select a destination by using the digital map.

To scroll within the map, drag the cursor in the required direction, then confirm the position as a destination.

Latitude Longitude

Enter the co-ordinates of the destination.

Confirm the destination

When a destination has been selected, the route appears on the map and a route summary is provided in the  tab.

Select the LIVE tab to view real-time traffic information. For further information, refer to (NAVI 80 IntelliLink) "LIVE services" in the "Usage" section ⇨ 165.

Touch **Done** to confirm the route.

Add and save a favourite**Add to saved locations**

From the Home page, touch **MENU** then **Navigation** followed by **Drive to...**

Select **Recent destinations** and choose a destination from the displayed list.

Touch **+** (to open a pop-up menu) then **Add to saved locations**, give a name to the destination using the keyboard, then touch **Next**.

A message is displayed asking if the saved address should be set as the Home address. Select **Yes** or **No**. A message is displayed confirming that the address has been saved.

Add Favourite

On the Home page, touch ★ to open the favourites menu and select **Navigation**.

To set a saved destination as a favourite, touch + (to open a pop-up menu), then **Add Favourite**.

Choose from the displayed list to add a saved destination to the favourites.

For further information, refer to (NAVI 80 IntelliLink) "Favourites" in the "Introduction" section ⇨ 128.

Delete a favourite

On the Home page, touch ★ to open the favourites menu and select **Navigation**.

Touch + and select **Remove all Favourites** or select a favourite from the displayed list then select **Remove a Favourite**. A confirmation message is displayed. Touch **Delete** to confirm.

For further information, refer to (NAVI 80 IntelliLink) "Favourites" in the "Introduction" section ⇨ 128.

Guidance

Route information

NAVI 50 IntelliLink

To view the route before guidance begins, touch 🏠 followed by 🗺️ **NAVI / ↑ Nav** then **Route** after a destination has been entered.

For the various methods of entering a destination, refer to (NAVI 50 IntelliLink) "Destination input" ⇨ 176.

The following options are available:

- **Create Route/Edit Route**
Refer to (NAVI 50 IntelliLink) "Edit Itinerary" below.
- **Avoidances**
Refer to (NAVI 50 IntelliLink) "Edit Itinerary" below.
- **Overview**
See below.

- **Cancel Route**
Refer to (NAVI 50 IntelliLink) "Deactivating guidance" below.
- **Alternative Routes**
Refer to (NAVI 50 IntelliLink) "Edit Itinerary" below.
- **Itinerary**
Refer to (NAVI 50 IntelliLink) "Edit Itinerary" below.

Overview

When the **Route** screen is displayed, touch **Overview** to get a detailed plan for the current route and a bird's eye view of the route on the map.

This menu option contains the following information:

- name and/or address of the destination
- total time of the route
- total distance of the route
- special points and sections of the route (e.g. toll roads, motorways, etc.)
- alternative routes (e.g. Short, Fast, Economical)

When the **Overview** screen is displayed, touch **Options** to access the following submenus:

- **Alternative routes**

Refer to (NAVI 50 IntelliLink) "Edit Itinerary" below.

- **Itinerary**

Refer to (NAVI 50 IntelliLink) "Edit Itinerary" below.

- **Route settings**

Refer to (NAVI 50 IntelliLink) "Setting up the navigation system" ⇨ 165.

- **Simulate navigation**

See below.

Notice

These options can also be accessed during route guidance by touching on the 'Journey information' (e.g. estimated arrival time, total remaining distance) area of the display screen.

Refer to (NAVI 50 IntelliLink) "Information on the display" in the "Usage" section ⇨ 165.

Simulate navigation

This function enables to see a rapid view of the suggested route.

The following options are available:

- ▶/|| : Start or pause the route simulation
- ⏪ : Move to previous manoeuvre
- ⏩ : Move to next manoeuvre
- 1x / 4x / 8x : Increase the speed of the route simulation
- ←/↶ : Return to previous screen

NAVI 80 IntelliLink

To view the route before guidance begins, touch **+** (to open a pop-up menu), then select **Route details** after a destination has been entered.

The following options are available:

- **Display instructions:**

Displays the route plan.

The following details are shown:

- direction change arrows
- road types

- road names
- distance before a fork in the road (km/miles)

- **Display route map:**

View a map of the route.

- **Display route demo:**

View a demonstration of the route.

- **Route summary:**

Return to the previous screen.

The details of the journey time, distance and the type of journey are displayed. Refer to (NAVI 80 IntelliLink) "IQ routes™" in the "Destination input" section ⇨ 176.

- **Display destination:**

View changes in direction as images.

- **Display traffic on route:**

Displays an overview of all traffic incidents affecting the current journey, with a detailed incident by incident view.

With a subscription to LIVE services, the "Live" tab provides

a more detailed overview of the journey (e.g. traffic delays, fixed and mobile speed cameras).

For further information, refer to (NAVI 80 IntelliLink) "LIVE services" in the "Usage" section ⇨ 165.

Edit itinerary

NAVI 50 IntelliLink

This function makes it possible to view and change the route plan to the destination entered.

To access at any time, touch  followed by **NAVI / Nav** then **Route**. Select **Itinerary**.

The following information will appear:

- direction change arrows
- road number
- distance before a direction change

Touch **Options** to change and sort the details of the route.

The following options are available:

- **Summary**

Shows each waypoint and the destination, including the waypoint distance, time left to next waypoint and arrival time.

- **Normal**

Shows each manoeuvre, with street or place names, distance, and route section numbers.

This option also shows signpost information, access and manoeuvre restrictions, warnings and system preference information.

- **Road list**

Shows only the main sections of the route using road names/ numbers.

This option also shows the length of each section, time left to next section, arrival time and average direction.

Alternatively, these itinerary/route options can be changed by touching the "Direction and distance to next change of direction" tab on the display





during route guidance. Select **Options** to change and sort the details of the route.

Refer to (NAVI 50 IntelliLink) "Information on the display", "Map screen" in the Usage section ⇨ 165.

Edit route

To edit the route by modifying the list of waypoints, touch  followed by **NAVI / Nav, Route** then **Edit Route** on the display screen.



The following options are available:

- Top  : Add waypoint
- Bottom  : Add new destination
-  : Delete destination
-  : Change the route departure address (available depending on version)

To change the order of the waypoints in the list, touch **Options** followed by **Re-order** then move the waypoints up/down.

For the various methods of entering a destination, refer to (NAVI 50 IntelliLink) "Destination input" ⇨ 176.

Avoidances

To edit the route by avoiding particular sections, touch  followed by  **NAVI** /  **Nav**, **Route** then

Avoidances.

Select a section from the list on the display screen to be avoided. The avoided section is highlighted in red.

Confirm the new route by touching **OK**.

Alternative routes

To change the route planning method, touch  followed by  **NAVI** /  **Nav**, **Route** then **Alternative routes**.

The following options are available, each with a distance and estimated time:

- fast
- short
- eco

Select one of the options and confirm the new route by touching .

For further information, refer to (NAVI 50 IntelliLink) "Setting up the navigation system" in the "Usage" section ⇨ 165.

NAVI 80 IntelliLink

Journeys can be planned in advance by selecting both the starting point and the destination.

From the Home page, touch **MENU** then **Navigation**, followed by **Itineraries**.

Select a point of departure in the same way as entering a destination. Refer to (NAVI 80 IntelliLink) "Destination input" ⇨ 176. Then select a destination, choose the type of route and confirm.

The system plans the route and allows you to view the details.

Change route

To change the route during active route guidance, from the Home page, touch **MENU** then **Navigation**, followed by **Change route**.

The following options are available:

- **Calculate alternative**
- **Cancel route**
- **Travel via**
- **Avoid roadblock**
- **Avoid part of route**
- **Minimise delays**

Calculate alternative

Select to calculate an alternative route to the destination.

Cancel route

Select to stop the current route guidance.

To restart guidance, touch **Drive to...** followed by **Recent destinations** and select the route again.

Travel via (waypoints)

Select to change the calculated route to your destination so that it includes a particular location (waypoint).

The location to be included is entered the same way as entering a destination.

Select from the same list of options, e.g. "Address", "Saved locations", "Point of Interest", "Point on map".

Refer to (NAVI 80 IntelliLink) "Destination input" ⇨ 176.

Avoid roadblock

Select this option in the event a roadblock is not currently indicated by the Traffic information service.

Refer to (NAVI 80 IntelliLink) "Traffic information" below.

Choose the distance (in metres) of the route ahead to be avoided, e.g. "100m", "500m", "2000m", "5000m".

The route is recalculated to avoid a section of the route for the distance selected.

Avoid part of route



Select to avoid a part of the route. Choose the road to be avoided from the list of roads along the route.

Minimise delays

Select to plan the route based on the latest traffic information.

Deactivating guidance

NAVI 50 IntelliLink

To stop route guidance when in progress, touch  followed by  **NAVI** /  **Nav**, **Route** then **Cancel Route**.

NAVI 80 IntelliLink

To stop guidance when in progress, touch  followed by **Delete route**.

Browse map

NAVI 50 IntelliLink

To access the map screen at any time, touch  followed by  **MAP**.

Touch anywhere on the map. The cursor indicates the current selected position. To scroll within the map, drag the cursor in the required direction.

For further control operations, refer to (NAVI 50 IntelliLink) "Map screen" in the "Usage" section ↪ 165.

Options menu

When the map screen is displayed, touch **Options** to display the following:

- **Route settings:**
Refer to (NAVI 50 IntelliLink) "Setting up the navigation system" in the "Usage" section ↪ 165.
- **Map settings:**
Refer to (NAVI 50 IntelliLink) "Setting up the navigation

system" in the "Usage" section ↪ 165.

- **Where am I?:**
Refer to (NAVI 50 IntelliLink) "HELP!" below.

NAVI 80 IntelliLink

To access the map screen without navigation, on the Home page touch **MENU**, then **Navigation** followed by **View Map**.

Touch anywhere on the map. The cursor indicates the current selected position. To scroll within the map, drag the cursor in the required direction.

When the map screen is displayed, touch  to open a pop-up menu containing the following options:

- **Use this location to...**
- **Find**
- **Change the map details**
- **Add to saved locations**

Use this location to...

Select this option to perform any of the following actions:

- centre the map on the vehicle's location
- navigate to a point on the map
- search for a point on the map
- add a point on the map to the favourites
- add a point on the map to the POI list
- correct the position of your vehicle

Find

Select this option to centre the map on:

- the saved home
- a saved address
- an address
- a recent destination
- a local search
- a point of interest
- current vehicle position
- a co-ordinate (latitude/longitude)

Change the map details

Select this option to switch on/off the following map settings:

- traffic
- names
- points of interest (POI)
- satellite image map background
- GPS co-ordinates

Add to saved locations

Select this option to add the current position on the map as a saved destination. Use the keyboard to enter a name or confirm the suggested name.

For keyboard operation, refer to (NAVI 80 IntelliLink) "**Operating keyboards in the display**" in the "**Usage**" section ⇨ 165.

Help!

NAVI 50 IntelliLink

When the map screen is displayed, touch **Options** followed by **Where am I?** to check helpful information about the current location and to search for Points of Interest (POI) nearby.

To access the map screen at any time, touch  followed by  **MAP**.

Where am I?

This menu option contains the following information:

- current location (address)
- latitude
- longitude
- altitude
- GPS status

Touch **Options** to display the following options:

- **Add to favourites**

Refer to (NAVI 50 IntelliLink) "Destination input", "Add and save a favourite" for further information ⇨ 176.

- **Country information:** Refer to "Country information" below.

Country information

This function allows you to check country information and legislation for the current location.

When the **Where am I?** screen is displayed, touch **Options** followed by **Country information**.

This menu option contains the following information:

- speed limits
- phone country code (International dialling code, e.g. +49)
- emergency number (e.g. 112)
- legal restrictions, e.g.:
 - vehicle equipment requirements, e.g. warning triangle, first aid kit, fire extinguisher, spare bulbs, high-visibility jacket etc.
 - headlights legislation
 - maximum blood alcohol level
 - snow chains legislation
 - winter tyres legislation

Help Nearby

This function allows you to search for assistance near the current location.

When the **Where am I?** screen is displayed, touch **Help Nearby**.

This menu option contains the following information:

- **Car repair around here** (Vehicle repair services)
- **Health around here** (Medical and emergency services)
- **Police around here** (Police stations)
- **Petrol station around here** (Fuel stations)

Select the appropriate option to access a list of local Points of Interest (POI).

For information on Points of Interest (POI), refer to (NAVI 50 IntelliLink) "Destination input" ⇨ 176.

Traffic information

NAVI 50 IntelliLink





Available depending on version, up-to-date traffic information from local sources can be received. Information is provided for the current route or for the current vehicle location.

During route guidance, touch **Options** then select **Current traffic**, or touch the traffic icon  on the map

screen. Traffic incidents along the route and estimated delay times are displayed.

The following options are available:

- **Event list:** Select to change event display settings.
- **Offer detour:** Create an alternative route to the selected destination.
- **Options:** Access traffic options.

To access these traffic options at any time, touch  followed by  **NAVI** /  **Nav** then **Options**. Then select  **Traffic**.

Touch  to return to route guidance.

NAVI 80 IntelliLink

Allows up-to-date traffic information from local sources to be received.

From the Home page, touch **MENU** then **Navigation**, followed by **Navigation Services**. Then select **Traffic/HD Traffic**.

The navigation system indicates traffic incidents with voice messages, the traffic information bar and also by displaying symbols on the map.

Refer to "Symbols overview" ⇨ 189.

The system receives updates approx. every 15 minutes and traffic incidents are shown for major roads only.

The **Traffic** service is named **HD Traffic** if a subscription to LIVE services has been activated. With **HD Traffic**, updates are received approx. every three minutes and traffic incidents are shown for minor roads also.

For further information, refer to (NAVI 80 IntelliLink) "LIVE services" in the "Usage" section ⇨ 165.

Depending on the current traffic situation, the traffic information bar can include the following information:

- heavy delays on the route (given in minutes)
- unknown or indeterminate situation (grey)
- slow traffic (orange)
- traffic jam (red)
- stationary traffic or road closed (dark red)
- distance before next incident (in km/miles)











To manage the Traffic information service, select from the following options:

- **Minimise delays**
Alter journey based on the latest traffic information.
- **Display traffic on route**
Displays an overview of all traffic incidents on the current route. Touch incident icons for more detailed information.
- **View map**
Select to explore the map and stay up-to-date with the traffic situation in the area.
The map displays the last searched location. Touch incident icons for more detailed information.
- **Read traffic information**
Activates voice guidance for traffic information.

Traffic settings

Select **Traffic settings** and tick the box alongside the required preferences (e.g. automatically minimise delays after every traffic update) and select **Done** to confirm.

Symbols overview

-  : Accident
-  : Traffic jam
-  : One or more lanes closed
-  : Road closed
-  : Traffic incident
-  : Road works
-  : Heavy rain
-  : Snow
-  : Strong wind, storm
-  : Fog
-  : Ice

Voice recognition

General information

The voice recognition function allows to operate certain functions via voice input.



To ensure that conversations held inside the vehicle do not start unintentional calls to a saved contact, the voice recognition function must first be activated via  on the column controls.

Control elements overview ⇨ 121.

NAVI 50 IntelliLink

Available depending on version, the voice recognition function of the handsfree phone system allows you to operate certain functions of a compatible smartphone via voice input.

Refer to "Phone control" in this section ⇨ 192.

To confirm that a paired and connected smartphone is compatible with the voice recognition function, touch  followed by  **Setting(s)**.

Then select **Connectivity** followed by **View Bluetooth device list**. The list shows the paired devices and  appears alongside the name of the smartphone to indicate compatibility.

Notice

If supported, the language set on the smartphone will automatically be used by the Infotainment system for voice recognition.

The navigation system can also be operated using voice controls. Refer to "Navigation control" in this section ⇨ 191.

Prerequisites



The following prerequisites must be met:



- The Bluetooth function of the Infotainment system must be activated.
Refer to "Bluetooth connection" in the "Phone" section ⇨ 196.
- The Bluetooth function of the Bluetooth-enabled smartphone must be activated and the smartphone must have a 3G, 4G

or wi-fi connection (see smartphone operating instructions).

- Dependent upon the smartphone, it may be required to set the device to "visible" (see smartphone operating instructions).
- The smartphone must be paired and connected to the Infotainment system.

Help

For information and help with activating and operating voice controls, touch  followed by  **Setting(s)** then **Connectivity**.

Select **Smartphone** from the list (use / to search list), then select  to access help.

A series of screens are displayed, explaining how to use the voice recognition function and information on the following:

- switching on/off with steering wheel/column controls
- compatible phones
- operation methods

- available functions and descriptions
- conditions of use

NAVI 80 IntelliLink

The voice recognition function allows to operate certain functions via voice input, including:

- **Navigation**

Refer to "Navigation control" in this section ⇨ 191.

- **Phone**

Refer to "Phone control" in this section ⇨ 192.

Press **3** on the column controls to open the **Voice control** main menu. After the tone, say the name of the menu you wish to access.

When activated, the **Voice control** main menu is displayed and the voice recognition indicator in the top right corner indicates system status and optimisation levels:

Green : optimal voice recognition
 Orange : good voice recognition
 Red : average voice recognition

Microphone  : System is ready to receive a voice command

Loudspeaker  : Voice instructions are currently being given by the system

Loading icon  : Data currently loading

Navigation control

NAVI 50 IntelliLink

Activating voice recognition

To activate the voice recognition function during navigation:

Press **3** on the column controls; **3** appears, alongside the audio system information, in the bottom right corner of the display.

Notice

During use of the voice recognition function, audio source playback is interrupted.

For a guide to using voice commands, refer to (NAVI 50 IntelliLink) "Help" in the "General information" section ⇨ 190.

NAVI 80 IntelliLink

Activating voice recognition

To activate the voice recognition function:

Press **3** on the column controls to open the **Voice control** main menu.

After the tone, say "**Destination**" to enter a new address. Say "**Address**" then say the full destination of a new address (number, street name, destination town/city).

The address recognised by the system is displayed. Confirm destination when prompted to begin guidance.

Alternatively, after the tone say "**Recent destinations**" to access a list of the most recent destinations entered and select the desired destination.

Notice

A compatible SD card must be inserted for the voice recognition to operate the navigation system.

For further information, refer to (NAVI 80 IntelliLink) "Destination input" in the "Navigation" section ⇨ 176.

Phone control

NAVI 50 IntelliLink

Activating voice recognition

To activate the voice recognition function:

Press **Ⓜ** on the column controls to open the **Smartphone** menu; a beep sounds and **Ⓜ** appears on the display, indicating activation.

To use voice recognition, touch **Ⓜ** on the display (or press **Ⓜ**).

Notice

During operation of the voice recognition function, **Radio** and **Media** functions are not available for use.

To deactivate, touch and hold **Ⓜ** on the display (or press **Ⓜ**).

For a guide to using voice commands, refer to (NAVI 50 IntelliLink) "Help" in the "General information" section ⇨ 190.

NAVI 80 IntelliLink

Activating voice recognition

To activate the voice recognition function:

Press **Ⓜ** on the column controls to open the **Voice control** main menu.

After the tone, say "**Phone**" to access the Phone menu. Say the name of a saved contact or a telephone number. The desired contact appears in the display when registered by the system.

Say "**Call**" to start the dialling process.

Say "**Delete**" to cancel input and retry.

Alternatively, to initiate a call directly from the **Voice control** main menu, touch **Ⓜ** and say the name of a saved contact or a telephone number.

Phone

General information

The handsfree phone system provides you with the possibility of having mobile phone conversations via the vehicle's microphone and loudspeakers, as well as operating the most important mobile phone functions via the Infotainment system.

To be able to use the handsfree phone system, the mobile phone must be connected with it via **Bluetooth**.

Not all handsfree phone system functions are supported by every mobile phone. The possible phone functions depend on the relevant mobile phone and network provider. Refer to the operating instructions for the mobile phone or consult the network provider.

Important information for operation and traffic safety

⚠ Warning

Use of the handsfree phone system while driving can be dangerous as your concentration is reduced when telephoning. Park the vehicle before using the handsfree phone system.

Follow the regulations of the country in which you are driving.

Also follow the special regulations that apply in specific areas and always switch off the mobile phone if the use of mobile phones is prohibited, if interference is caused by the mobile phone or if dangerous situations can occur.

⚠ Warning

Mobile phones have effects on your environment. For this reason, safety regulations have been

prepared which you should make yourself familiar with before you use the telephone.





Bluetooth

The Phone portal is certified by the Bluetooth Special Interest Group (SIG).



Further information about the specification will be found on the Internet at <http://www.bluetooth.com>

Phone controls

Controls on Infotainment system or steering column:

-  **TEL**
- or -
- **TEL**
- or -
-  **PHONE** on the  Home page screen (NAVI 50 IntelliLink)
- or -
•  **PHONE** in the Main menu screen (NAVI 80 IntelliLink)
Select **Phone** to open the menu.

Controls on steering column:

-  , : Take call, end/reject call.
- or -
- **MODE/OK**: Take call, end/reject call, confirm an action.
- : Activate/deactivate voice recognition.

Depending on Infotainment system, some features of the handsfree phone system can also be operated via voice recognition  192.

Display screen operation

Radio 15 USB

- To move up/down in the display: Turn **OK**.
- To confirm actions: Press **OK**.
- To cancel actions (and return to previous menu): Press .

NAVI 50 IntelliLink

To access the Phone menu screen, select  followed by  **Phone**.

The following submenus are available:

- **Phone Book**
- **Calling Lists**
- **Dial**

To switch between submenus, touch **▼** in top left corner.

- To move up/down in the display: Touch **▲** or **▼**.
- To confirm actions: Select **OK**.
- To cancel actions (and return to previous menu/Home page): Touch **←/⌂**.

For further information, refer to "Touchscreen operation" ⇨ 135.

NAVI 80 IntelliLink

To access the "Phone" menu from the Home page, select **MENU** followed by **Phone**.

The following submenus are available:

- **Phonebook**
- **Call logs**
- **Dial a number**

- **Voice mail**
- **Settings**
- To move up/down in the display: Touch **↑** or **↓**.
- To cancel actions (and/or return to previous menu): Touch **←**.
- To open a pop-up menu (e.g. to add contacts to a list of favourites): Touch **+**.

Notice

Favourites can be accessed at any time by pressing **★** on the Home page.

For further information, refer to "Touchscreen operation" ⇨ 135.

Operating keyboards in the display

Radio 15 USB

To move within and to enter characters in the numerical keyboard shown on the display screen: Turn and press **OK**.

Entries can be corrected during input with the **←** keyboard character.

Press **→** to stop using the keyboard and return to the previous screen.

NAVI 50 IntelliLink, NAVI 80 IntelliLink

To move within and to enter characters in the numerical keyboard, make the appropriate selection by touching the display screen.

Entries can be corrected during input with the **✕** keyboard character.

Depending on version, touch **←** to stop using the keyboard and return to the previous screen.

For further information, refer to "Touchscreen operation" ⇨ 135.

Connection

A mobile phone must be connected to the handsfree phone system in order to control its functions via the Infotainment system.

No phone can be connected to the system unless it has first been paired. Refer to the **Bluetooth connection** section (⇨ 196) for pairing a mobile phone to the handsfree phone system via Bluetooth.

When the ignition is switched on, the handsfree phone system searches for paired phones in the vicinity.

Bluetooth must be activated on the mobile phone for the phone to be recognised by the handsfree phone system. Searching continues until a paired phone is found. A display message indicates that the phone is connected.

Notice

When a Bluetooth connection is active, using the handsfree phone system will discharge the mobile phone battery more rapidly.

Automatic connection

For your phone to connect automatically when the system is switched on, it may be necessary to activate the automatic **Bluetooth** connection function on your mobile phone; refer to the mobile phone operating instructions.

Notice

Depending on Infotainment system, when reconnecting to a paired phone, or when two paired phones are within range of the handsfree

phone system, either the priority phone (if defined) or the last connected phone is connected automatically, even if this phone is outside the vehicle but still within range of the handsfree phone system.

During automatic connection, if a call is already in progress, the conversation will automatically switch to the vehicle's microphone and loudspeakers.

If connection fails:

- check the phone is switched on
- check the phone battery is not flat
- check if the phone has already been paired

The Bluetooth function on the mobile phone and on the handsfree phone system must be active and the mobile phone must be configured to accept the system connection request.



Manual connection

Radio 15 USB

To change the phone connected to the handsfree phone system, press **TEL** and select the **Select Device** menu. The device list shows the phones already paired.

Select the desired phone from the list and confirm by pressing **OK**. A display message confirms phone connection.

NAVI 50 IntelliLink

To change the phone connected to the handsfree phone system, touch  followed by  **Settings** then **Connectivity** (or select **Phone** from the Home page).

Then select **View Bluetooth device list**. The device list shows the phones already paired.

Select the desired phone from the list and confirm by touching **OK**. Depending on version,  appears alongside the selected phone, to indicate connection.

NAVI 80 IntelliLink

To change the phone connected to the handsfree phone system, from the Home page, touch **MENU** then **Phone** followed by **Settings**.

Then select **Manage devices**. The device list shows the phones already paired. Select the desired phone from the list.

Disconnecting a phone

If the mobile phone is switched off, the phone is automatically disconnected from the handsfree phone system.

During disconnection, if a call is already in progress, the conversation will automatically switch to the mobile phone.

Radio 15 USB

To disconnect a phone from the Infotainment system, press **TEL** (or the **SETUP**) and select **Bluetooth connection**. Select the desired device from the device list then select **Disconnect the device** by turning and pressing **OK**. A display message confirms phone disconnection.

NAVI 50 IntelliLink

Depending on version, to disconnect a phone from the Infotainment system, touch **Phone** followed by **Settings** then **Connectivity** (or select **Phone** from the Home page).

Then select **View Bluetooth device list**. Select the connected phone shown in the displayed list to disconnect; appears alongside the phone, to indicate disconnection.

NAVI 80 IntelliLink

To disconnect a phone from the Infotainment system, from the Home page, touch **MENU** then **Phone** followed by **Settings**.

Then select **Manage devices**. Select the connected phone in the displayed list to disconnect.

Defining the priority phone

Radio 15 USB

The priority phone is the last connected phone.

When the ignition is switched on, the handsfree phone system searches first for the priority paired phone. Searching continues until a paired phone is found.

Bluetooth connection

Bluetooth is a radio standard for the wireless connection of, e.g., a telephone with other devices.

Information such as a mobile phone contact list and call lists can be transferred. The functionality can be restricted depending on the phone model.

Prerequisites

The following prerequisites must be met, in order to control a Bluetooth-enabled mobile phone via the Infotainment system:

- The Bluetooth function of the Infotainment system must be activated.
- The Bluetooth function of the Bluetooth-enabled mobile phone must be activated (see mobile phone operating instructions).

- Dependent upon the mobile phone, it may be required to set the device to "visible" (see mobile phone operating instructions).
- The mobile phone must be paired and connected to the Infotainment system.

Activating Bluetooth function of the Infotainment system

Radio 15 USB

To enable the Infotainment system to recognise and operate a Bluetooth-enabled mobile phone, the Bluetooth function must first be activated. Deactivate the function if not required.

Press **TEL** and select **Bluetooth** by turning and pressing **OK**.

Select **ON** or **OFF** and confirm by pressing the knob.

NAVI 50 IntelliLink

Touch **⌘** followed by **⚙ Settings**.

Select **Connectivity** to display the following options:

- **View Bluetooth device list**
- **Search for Bluetooth device**

- **External device authorization**
- **Change passkey**
- **Smartphone**

Available depending on version. For help with activating and operating voice controls - refer to "Voice recognition" ⇨ 190).

When the **Connectivity** screen is displayed, Bluetooth-enabled devices can be paired to the Infotainment system.

NAVI 80 IntelliLink

To access the Phone settings menu from the Home page, touch **MENU** then **Phone** followed by **Settings**.

The following options are displayed:

- **Manage devices**
- **Sound levels**
- **Voice mail**
- **Activate Bluetooth**
- **Automatically download phone data** (on/off)

Select **Turn Bluetooth on** to tick the box alongside it. Bluetooth-enabled devices can now be paired to the Infotainment system.

Refer to (NAVI 80 IntelliLink) "Phone settings" in the "Operation" section for further information ⇨ 200.

Pairing a mobile phone to the handsfree phone system

In order to use the handsfree phone system, a connection must be set up between the mobile phone and the system via **Bluetooth**, i.e. the mobile phone must be paired to the vehicle before using it. For this purpose, the mobile phone must support Bluetooth. Refer to the operating instructions for the mobile phone.

To set up a Bluetooth connection, the handsfree phone system must be switched on and Bluetooth must be activated on the mobile phone.

Notice

If another phone is automatically connected during a new pairing procedure, it will automatically be disconnected, to allow the new pairing procedure to continue.

Pairing enables the handsfree phone system to recognise and store a mobile phone in the device list. A

maximum of five mobile phones can be paired and stored in the device list, but only one can be connected at a time.

Notice

Depending on version of NAVI 50 IntelliLink, a maximum of eight mobile phones can be paired.

When pairing is completed, a message with the name of the paired phone is shown on the Infotainment system display screen and the phone is automatically connected to the handsfree phone system. The mobile phone can then be operated via the Infotainment system controls.

Notice

When a Bluetooth connection is active, using the handsfree phone system will discharge the mobile phone battery more rapidly.

Radio 15 USB

To pair a phone to the handsfree phone system, press **TEL** and select **Pair device** by turning and pressing **OK**. The **Ready to Pair** screen is displayed.

On the mobile phone, search for Bluetooth equipment in the vicinity of the device.

Select **My Radio** (i.e. the name of the handsfree phone system) from the list on the mobile phone, then, on the mobile phone keypad, enter the pairing code shown on the Infotainment system display screen.

If pairing fails, the system returns to the previous menu and a corresponding message is displayed. Repeat procedure if necessary.

NAVI 50 IntelliLink

Touch  followed by  **Settings**.

Select **Connectivity** then either **Search for Bluetooth device** or **External device authorization**.

Alternatively, when in the **Phone** menu screen, touch .

On the mobile phone, search for Bluetooth equipment in the vicinity of the device.

Select the name of the handsfree phone system (e.g. **MEDIA-NAV**) from the list on the mobile phone, then (if required), on the mobile phone

keypad, enter the pairing code shown on the Infotainment system display screen.

Notice

The pairing code may only be shown on the Infotainment system display for a limited time.

The default pairing code is **0000**. To change this pairing code before the pairing procedure is started, select **Change passkey** to update.

If pairing fails, repeat procedure if necessary.

NAVI 80 IntelliLink

To access the Phone settings menu from the Home page, touch **MENU** then  **Phone** followed by **Settings**.

Select **Manage devices** from the list of options. A message appears on the display asking if you wish to set up a Bluetooth connection between your device and the Infotainment system. Select **Yes** to continue. The Infotainment system begins a search for Bluetooth equipment in the vicinity and displays a list of devices.

Select your device from the displayed list. Depending on phone model, confirm the pairing request or enter the pairing code on the mobile phone keypad to pair it to the Infotainment system.

To pair further devices, from the **Manage devices** screen, touch **+** to open a pop-up menu and select **Add** to pair additional devices in the same way.

If pairing fails, repeat procedure if necessary.

Unpairing a mobile phone from the handsfree phone system

If the list of paired phones is full, a new phone can only be paired if an existing phone is unpaired.

Notice

Unpairing a phone erases all of its downloaded contacts and its call history from the handsfree phone system phonebook.

Radio 15 USB

To unpair, i.e. to delete a phone from the handsfree phone system memory, press **TEL** and select **Delete device**.

Select the desired phone from the device list and press **OK** to confirm deletion when prompted.

NAVI 50 IntelliLink

To unpair, i.e. to delete a phone from the handsfree phone system memory, touch **☰** followed by **⚙️ Settings**.

Select **Connectivity** then **View Bluetooth device list**.

Select the desired phone from the device list, then touch **☒** to delete the device. If required, delete all devices in the list by selecting **Options** followed by **Delete all**. Confirm by touching **OK**.

NAVI 80 IntelliLink

To unpair, i.e. to delete a phone from the handsfree phone system memory, access the **Manage devices** screen.

From the Home page, touch **MENU** then **☰ Phone** followed by **Settings**.

Select **Manage devices**, then touch **+** to open a pop-up menu, select **Delete** and remove the selected device from the list.

Emergency call

Warning

Do not end the call until you are requested to do so by the emergency call centre.

NAVI 50 IntelliLink

To view the emergency number for the current location, touch **☰** followed by **📍 MAP** (available depending on version).

Select **Options** then **Where am I?**

When the **Where am I?** screen is displayed, touch **Options** followed by **Country information**: Emergency number (e.g. 112) is shown on the display.

Operation

Introduction

When a Bluetooth connection has been set up between a mobile phone and the hands-free phone system, certain functions of the mobile phone can be operated via the Infotainment system controls or display.

It is then possible, e.g., to import the contacts and telephone numbers stored on the mobile phone into the handsfree phone system.

Notice

The Infotainment system memory is restricted and some the contacts may not be downloaded from the mobile phone.

The contacts saved on the SIM card in the mobile phone are not visible. Only contacts saved on the phone are visible.

After connection, the mobile phone data is transmitted to the handsfree phone system. This can take some time, depending on phone model. During this period, operation of the





mobile phone is possible via the Infotainment system only to a limited extent.

Notice

Not every mobile phone supports the functions of the handsfree phone system. Therefore, deviations from the range of functions described are possible.



Phone menu

To display the **Phone** menu:



- press  **TEL**
- or -
- press **TEL**
- or -
- touch  followed by  **Phone** (NAVI 50 IntelliLink)
from the Home page, touch **MENU** followed by  **Phone** (NAVI 80 IntelliLink)

Volume control

Radio 15 USB



During a call, turn  or press  or  (on the steering column controls) to change the call volume.

NAVI 50 IntelliLink

During a call, press  or  with the steering column controls to change the call volume.

NAVI 80 IntelliLink

During a call, turn  on the Infotainment unit to change the call volume.

Alternatively (with the steering column controls), press  or .



Dialling a telephone number

Several options are available for dialling telephone numbers, including calling a contact from the phonebook or from a call log. Numbers can also be dialled manually.

Entering a number manually

Radio 15 USB

With the **Phone** menu displayed, select **Dial** from the list.

Enter the desired number using the numerical keyboard ( 192) and select  to start dialling.

To redial the last number, press and hold **TEL**.

NAVI 50 IntelliLink

With the **Phone** menu displayed, touch **▼** in top left corner and select **Dial** from the list.

Enter the desired number using the numerical keyboard and select **Phone** to start dialling.

Refer to (NAVI 50 IntelliLink) "Operating keyboards in the display" in the "General information" section ⇨ 192.

Entries can be corrected during input with the **✕** keyboard character. Touch and hold **✕** to delete all numbers at once.

NAVI 80 IntelliLink

From the Home page, select **MENU** then **Phone** followed by **Dial a number**.

Enter the desired number using the numerical keyboard and touch **Call** to start dialling.

Entries can be corrected during input with the **✕** keyboard character.

Phonebook

The phonebook contains contact lists available only to the current vehicle user. For reasons of confidentiality, each downloaded contacts list can only be viewed when the corresponding phone is connected.

Radio 15 USB

After pairing the mobile phone to the Infotainment system, the contact list in the mobile phone is downloaded to the handsfree phone system.

To dial a number from the phonebook, with the **Phone** menu displayed, select **Phonebook** and select the desired contact from the alphabetical list. Press **OK** to start the dialling process.

NAVI 50 IntelliLink

After pairing the mobile phone to the Infotainment system, the contact list in the mobile phone is downloaded to the handsfree phone system.

With the **Phone** menu displayed, touch **▼** in top left corner and select **Phone Book** from the list.

To dial a number from the phonebook, select the desired contact from the list.

Alternatively, select **Search by Name**, then enter the name of the desired contact using the keyboard.

Refer to (NAVI 50 IntelliLink) "Operating keyboards in the display" in the "General information" section ⇨ 192.

NAVI 80 IntelliLink

After pairing the mobile phone to the Infotainment system, the contact list in the mobile phone is downloaded to the handsfree phone system.

Notice

Data sharing must be authorised on the phone. Refer to the operating instructions for the mobile phone or consult the network provider.

The feature "Automatically download phone data" must also be switched on in the Infotainment phone settings menu. Refer to (NAVI 80 IntelliLink) "Phone settings" below.

From the Home page, touch **MENU** then **Phone** followed by **Phone book**.

To dial a number from the phonebook, select the desired contact from the list. If a contact has more than one saved number, select the appropriate number when prompted. The call will be started automatically after the contact number is selected.

Alternatively, select **Find**, then enter the name of the desired contact using the keyboard.

After the initial pairing of the phone with the Infotainment system, the system can be updated with the latest contacts on the mobile phone. Touch **+** to open a pop-up menu and select **Update phone data**. If necessary, select **Help** from the pop-up menu for assistance.

To add a contact to your list of favourites, press **+** and select **Add a contact to the Favourites page**.

Notice

Favourites can be accessed at any time by pressing **★** on the Home page.

For further information, refer to (NAVI 80 IntelliLink) "Favourites" in the "Introduction" section ⇨ 128.

Call lists

Radio 15 USB

To dial a number from the call history lists (e.g. dialled numbers, received calls, missed calls), select the relevant option, e.g. **Dialled numbers** from the **Call list** menu. Select the desired contact and press **OK** to start the dialling process.

NAVI 50 IntelliLink

After connecting the mobile phone to the Infotainment system, the list of dialled numbers, received calls and missed calls in the mobile phone are transferred automatically to the handsfree phone system.

With the **Phone** menu displayed, touch **▼** in top left corner and select **Calling Lists** from the list.

To dial a number from the call history lists, select from the following options on the display:

- **All**: Displays list of all calls in the below lists.
- **Phone**: Dialled numbers.
- **Phone**: Received calls.
- **Phone**: Missed calls.

Notice

The number of missed calls is shown alongside the symbol.

The most recent calls are displayed at the top. Select the desired contact from the chosen list to start the dialling process.

NAVI 80 IntelliLink

After connecting the mobile phone to the Infotainment system, the list of dialled numbers, received calls and missed calls in the mobile phone are transferred automatically to the handsfree phone system.



Notice

Data sharing must be authorised on the phone. Refer to the operating instructions for the mobile phone or consult the network provider.

The feature "Automatically download phone data" must also be switched on in the Infotainment phone settings menu. Refer to (NAVI 80 IntelliLink) "Phone settings" below.

From the Home page, touch **MENU** then **Phone** followed by **Call logs**.

To dial a number from the call history lists, select from the following options on the display:

- **All**: Displays list of all calls in the below lists.
- : Received calls.
- : Missed calls.
- : Dialled numbers.

The most recent calls are displayed at the top. Alternatively, touch \uparrow or \downarrow to move up/down in the display.

Select the desired contact from the chosen call list to start the dialling process.

Notice

If necessary, touch **+** (to open a pop-up menu) and select **Update telephone data** to update the call lists.

Voice mail box

Radio 15 USB

To listen to mobile phone voicemail messages via the Infotainment system while the phone is connected, select the **Voice mail box** menu.

NAVI 80 IntelliLink



To listen to mobile phone voicemail messages via the Infotainment system while the phone is connected, from the Home page, select **MENU** then **Phone** followed by **Voice mail**. The system will call the configured voicemail box.

The configuration screen will be displayed if the voicemail box is not configured. Enter number on the numerical keyboard and confirm.



Receiving calls

Radio 15 USB

To accept the call, depending on vehicle configuration:

- Briefly press  (on the steering column controls).
- Select the  icon in the display (by turning and pressing **OK**).

To reject the call, depending on vehicle configuration:

- Press and hold  (on the steering column controls).
- Select the  icon in the display (by turning and pressing **OK**).

When receiving a call, the caller number may be shown on the Infotainment system display screen. If the number is stored in the system memory, the name is displayed instead. If the number cannot be displayed, the message **Private number** is shown.

NAVI 50 IntelliLink

To accept the call:

- Touch **Accept/Agree**.
- Briefly press  (on the steering column controls).

To reject the call:

- Touch **Refuse/Reject**.
- Press and hold  (on the steering column controls).

When receiving a call, the caller number may be shown on the Infotainment system display screen. If the number is stored in the system memory, the name is displayed instead. If the number cannot be displayed, the message **Unknown/Unknown number** is shown.

NAVI 80 IntelliLink

To accept the call:

- Touch **Pick up**.
- Briefly press  (on the steering column controls).

To reject the call:

- Touch **Reject**.
- Press and hold  (on the steering column controls).

When receiving a call, the caller number may be shown on the Infotainment system display screen. If the number is stored in the system memory, the name is displayed instead. If the number cannot be displayed, the message **No Caller ID** is shown.

Functions during a telephone call

Radio 15 USB

In addition to volume control, various functions are available during a call, including:



- Switch the call to the mobile phone.
- Access the keyboard.
- End call.

Turn and press **OK** to select and confirm.

Switch the call from the handsfree phone system to the mobile phone by selecting the mobile phone display item. Some mobile phones may become disconnected from the handsfree phone system during the switch to this mode.







A number can also be entered on the numerical keyboard ( 192) e.g. to control a voice server such as the voicemail box. Select the **#123** display item to access the numerical keyboard. Refer to **"Voicemail box"** for further information.

To end the call, depending on vehicle configuration:

- Briefly press .
- Press **TEL**.
- Select the  icon in the display.

NAVI 50 IntelliLink

In addition to volume control, various functions are available during a call, including:

- : End call.
- : Switch vehicle microphone off.
- : Switch vehicle microphone on.
- : Transfer conversation to mobile phone.
- : Transfer conversation to vehicle's microphone and loudspeakers.
- : Return to previous screen (e.g. navigation or Home page).

NAVI 80 IntelliLink

In addition to volume control, various functions are available during a call, including:

- Place call on hold: Touch **+** (to open pop-up menu) then select **On hold**. Touch **Continue** to resume the call.
- Transfer conversation to mobile phone: Touch **+** (to open pop-up menu) then select **Handset**.
In some cases, the phone may be disconnect from the Infotainment system during a call transfer.
- End call: Touch **End call**.
- Return to previous menu: Touch **←**.

Phone settings

NAVI 50 IntelliLink

Restore default phone settings

To access the settings menu at any time, touch **⌘** followed by **⚙️SETTING(S)**.

Select **System** followed by **Factory settings** then **Phone** to restore phone settings to their default values. Confirm by touching **OK**.

Display software version

To access the settings menu at any time, touch **⌘** followed by **⚙️SETTING(S)**.

Select **System** followed by **System version** to display the software version.

NAVI 80 IntelliLink

From the Home page, touch **MENU** then **📞Phone** followed by **Settings**.

Select from the following options:

- **Manage devices:**
Refer to (NAVI 80 IntelliLink) "Pairing a mobile phone" in the "Bluetooth connection" section **⇨** 196.
- **Sound levels:**
To set the handsfree phone system call volume and the ringtone.

- **Voice mail:**
Refer to (NAVI 80 IntelliLink) "Voicemail box" above.
- **Activate Bluetooth:**
Refer to (NAVI 80 IntelliLink) "Activating Bluetooth" in the "Bluetooth connection" section **⇨** 196.
- **Automatically download phone data:**
Select this option to tick the box alongside it.
When pairing and/or connecting the mobile phone to the Infotainment system, the contact list and call lists in the mobile phone can now be downloaded to the handsfree phone system.
Data sharing must also be authorised on the phone. Refer to the operating instructions for the mobile phone or consult the network provider.

Mobile phones and CB radio equipment

Installation instructions and operating guidelines

The vehicle specific installation instructions and the operating guidelines of the mobile phone and handsfree manufacturer must be observed when installing and operating a mobile telephone. Failure to do so could invalidate the vehicle type approval (EU directive 95/54/EC).

Recommendations for fault-free operation:

- professionally installed exterior antenna to obtain the maximum range possible
- maximum transmission power ten watts
- installation of the phone in a suitable spot, consider relevant Note in the Owner's Manual section **Airbag system**

Seek advice on predetermined installation points for the external antenna or equipment holder and

ways of using devices with a transmission power exceeding ten watts.

Use of a handsfree attachment without external antenna with mobile telephone standards GSM 900/1800/1900 and UMTS is only permitted if the maximum transmission power of the mobile telephone is two watts for GSM 900 or one watt for the other types.

For reasons of safety, do not use the phone while driving. Even use of a handsfree set can be a distraction while driving.

Warning

Operation of radio equipment and mobile telephones which fail to meet above mentioned mobile telephone standards is only permitted using an antenna located outside of the vehicle.

Caution

Mobile telephones and radio equipment may lead to malfunctions in the vehicle electronics when operated inside the vehicle with no exterior antenna, unless the above mentioned regulations are observed.

Climate control

Climate control systems	207
Heating and ventilation system	207
Air conditioning system	208
Electronic climate control system	209
Rear heating system	212
Rear air conditioning system ...	214
Auxiliary heater	215
Air vents	220
Adjustable air vents	220
Fixed air vents	221
Glovebox cooler	221
Maintenance	222
Air intake	222
Air conditioning regular operation	222
Service	222

Climate control systems

Heating and ventilation system



Controls for:

- temperature
- fan speed
- air distribution
- demisting and defrosting

Heated rear window  ⇨ 42.

Heated seats  ⇨ 51.

Temperature



red : warm
blue : cold

Heating will not be fully effective until the engine has reached normal operating temperature.

Fan speed



Adjust the air flow by switching the fan to the desired speed.



Air distribution



 : to head area

 : to head area and foot well



 : to foot well

-  : to windscreen, front door windows and foot well
-  : to windscreen and front door windows

Intermediate settings are possible.



Demisting and defrosting the windows



- Switch cooling **A/C** on if available.
- Set temperature control to warmest level.
- Set fan speed to highest level.
- Set air distribution control to .
- Switch on heated rear window .

- Open side air vents as required and direct them towards door windows.
- For simultaneous warming of the foot well, set air distribution control to .

Notice

If  is pressed while the engine is running, an Autostop will be inhibited until  is pressed again.

If  is pressed while the engine is in an Autostop, the engine will restart automatically.

Stop-start system ⇨ 227.

Air conditioning system

Cooling (A/C)



Press **A/C** to switch on cooling. The LED in the button illuminates to indicate activation. Cooling is only functional when the engine is running and climate control fan is switched on. Press **A/C** again to switch off cooling.

The air conditioning system cools and dehumidifies (dries) the air when outside temperature is a little above the freezing point. Therefore condensation may form and drip from under the vehicle.

If no cooling or drying is required, switch the cooling system off to save fuel.

Notice

If the climate control is set to maximum cooling while the ambient temperature is high, an Autostop may be inhibited until the required temperature in the passenger compartment has been reached.

If the climate control is set to maximum cooling while the engine is in an Autostop, the engine may restart automatically.

Stop-start system ⇨ 227.

Air recirculation system



Press  to activate air recirculation mode. The LED in the button illuminates to indicate activation.

Press  again to deactivate air recirculation mode.



Warning



The exchange of fresh air is reduced in air recirculation mode. In operation without cooling the air humidity increases, so the windows may mist up. The quality of the passenger compartment air deteriorates, which may cause the vehicle occupants to feel drowsy.

Electronic climate control system



Controls for:

- temperature
- air distribution ( or ) and menu selection
- fan speed 

AUTO : automatic mode
 : air recirculation
 : demisting and defrosting
 : heated rear window, heated exterior mirrors
A/C OFF : switch off air conditioning

Heated rear window  ⇨ 42.

Heated exterior mirrors  ⇨ 39.

Heated seats  ⇨ 51.

The preselected temperature is automatically regulated. In automatic mode, the fan speed and air distribution automatically regulate the air flow.

The system can be manually adapted by use of air distribution and air flow controls.

The electronic climate control system is only fully operational when the engine is running.

For correct operation, do not cover the sensor on the instrument panel.

Automatic mode



Basic setting for maximum comfort:

- Press **AUTO** (**AUTO** appears in the display).
- Set desired temperature (the temperature appears in the display).
- Open all air vents.

During automatic mode, the settings for fan speed, air distribution, air conditioning and air recirculation are automatically regulated by the system and are not shown on the display.

Temperature preselection



Temperatures can be set to the desired value with the two buttons below the display.

For reasons of comfort, change temperature only in small increments.

red : warm
blue : cold

Heating will not be fully effective until the engine has reached normal operating temperature.

If the minimum temperature of 15 °C is set, the electronic climate control system runs at maximum cooling.

If the maximum temperature of 27 °C is set, the electronic climate control system runs at maximum heating.

Notice

If the temperature is to be reduced for climate comfort reasons, an Autostop can be inhibited or the engine will restart automatically when cooling is switched on.

Stop-start system ⇨ 227.

Fan speed



Fan speed can be increased or decreased with the  buttons.

The selected fan speed is indicated with  in the display.

If the fan is switched off, the air conditioning is also deactivated.

To return to automatic mode: Press **AUTO**.

Demisting and defrosting the windows





Press . The LED illuminates.

Temperature and air distribution are set automatically, air conditioning is switched on and the fan runs at a high speed.

Heated rear window, heated exterior mirrors are also switched on automatically. Press  to switch off without deactivating demisting / defrosting of the windows. The fan speed can also be decreased.

To return to automatic mode: press  or **AUTO**.

Notice

If  is pressed while the engine is running, an Autostop will be inhibited until  is pressed again.





If  is pressed while the engine is in an Autostop, the engine will restart automatically.

Stop-start system ⇨ 227.

Air distribution

Press  or  repeatedly.

Arrows shown in the display indicate the distribution settings:

-  : to windscreen and front door windows
-  : to windscreen, front door windows and foot well
-  : to head area
-  : to head area and foot well
-  : to foot well

To return to automatic mode, press **AUTO**.

Cooling



The air conditioning system cools and dehumidifies (dries) when outside temperature is above a specific level. Therefore condensation may form and drip from under the vehicle.



If no cooling or drying is required, press **A/C OFF** to switch the cooling system off, thus saving fuel.

A/C OFF appears in the display.

Manual air recirculation mode

Press  to switch on air recirculation.  appears in the display.

Warning

The exchange of fresh air is reduced in air recirculation mode. In operation without cooling the air humidity increases, so the windows may mist up. The quality of the passenger compartment air deteriorates, which may cause the vehicle occupants to feel drowsy.

To return to automatic mode, press  or **AUTO**.

Rear heating system



If the engine is switched off, the rear compartment can be heated by the additional heating, through low level vents.

By programming values using the control panel, the user can adjust the time, day and temperature settings.

Heating will cease to operate if the vehicle fuel level drops too low.

During operation, power from the vehicle battery is used. For short journey times, check the vehicle battery regularly and recharge if necessary.

Notice

If the rear heating system is activated while the engine is running, an Autostop will be inhibited.

To ensure efficient performance, the low level air vents in the rear passenger compartment must not be obstructed.

Warning

Do not operate the system when refuelling, when dust or combustible vapours are present or in enclosed spaces (e.g. garage).



Warning

If the warning light illuminates in combination with the hazard warning flashers, stop vehicle and switch off engine as soon as possible. Evacuate the vehicle, there is a risk of fire.

Timer

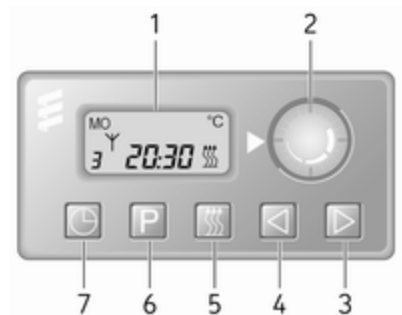

- 1 Display** : Displays preset, weekday or preset day, current time or preset time, temperature, ∇ and ||||
- 2 Temperature** : Selects temperature
- 3 \blacktriangleright** : Adjusts values up
- 4 \blacktriangleleft** : Adjusts values down
- 5 ||||** : Selects heat settings

- 6 P** : Selects preset settings
- 7 \odot** : Selects time and weekday settings

Operation

Heating ||||

Press |||| , the predetermined heating duration, e.g. **30** is displayed.

To temporarily adjust the heating duration, adjust using \blacktriangleleft or \blacktriangleright . The value can be set from 10 to 120 minutes. Due to the power consumption, note the heating duration.

To switch off, press |||| .

To change the default predetermined heating duration, ensure the heater is switched off, press and hold \blacktriangleleft until the display flashes and adjust using \blacktriangleleft or \blacktriangleright .

Programming P

Up to three preset departure times during one day, or one preset departure time over one week can be programmed.

- Press **P** once to select preset memory number **1**.
- Press **P** twice to select preset memory number **2**.
- Press **P** three times to select preset memory number **3**.
- Press **P** again to exit the preset memory.

Start heating within 24 hours

- Press **P** to select desired preset memory number **1**, **2** or **3**.
- Briefly press \blacktriangleleft or \blacktriangleright . The preset time flashes.
- Adjust the preset time using \blacktriangleleft or \blacktriangleright .
- Press **P** to confirm and exit the preset memory.

Start heating up to seven days

- Press **P** to select desired preset memory number **1**, **2** or **3**.
- Briefly press \blacktriangleleft or \blacktriangleright . The preset time flashes.
- Adjust the preset time using \blacktriangleleft or \blacktriangleright .

- After 5 seconds the preset day flashes.
- Adjust the preset day using ◀ or ▶.
- The preset time and day are set once the display changes to the current time.

Set time and weekday ☉

If the vehicle battery is disconnected or its voltage is too low, the unit will need to be reset.

- Press ☉ until the time flashes.
- Press ◀ or ▶ to change the current time.
- Time is stored when the display stops flashing.
- Wait for weekday to flash.
- Press ◀ or ▶ to change the weekday.
- Weekday is stored when the display stops flashing.

Heating level

The preferred heating level for programmed departure times can be set between 10 to 30 °C.

To adjust the temperature of the heating, turn the rotary knob located on the control panel.

- turn clockwise : increase temperature
- turn anticlockwise : decrease temperature

Rear air conditioning system

The rear air conditioning system is activated in conjunction with the front passenger compartment air conditioning system.

Bus

Fan speed



Adjust the air flow to select the desired speed.

- turn clockwise : increase air flow
- turn anticlockwise : decrease air flow

Notice

Rear air conditioning cannot be switched on during an Autostop. Stop-start system ↻ 227.

Combi

Additional air conditioning is supplied to the rear passenger compartment via the air vents located above the driver and front passenger compartment.

With the front passenger compartment air conditioning system switched on, adjust the air flow to select the desired speed.

Ensure the air vents are open when in use, to prevent ice forming in the system due to lack of air movement.

Auxiliary heater

Coolant heater

The engine-independent, fuel-powered coolant heater provides rapid heating of the engine coolant to enable heating of the vehicle interior without the engine running.

Notice

Depending on version, an additional coolant heater may be switched on automatically to speed up heating when the ignition is on and the outside temperature is below 5 °C.

⚠ Warning

Do not operate the system when refuelling, when dust or combustible vapours are present or in enclosed spaces (e.g. garage).

Before starting or programming the system to start, turn the vehicle's climate control system to heat, set the air distribution to  and turn the fan on.

Switch off when not required. Heating stops automatically after the programmed runtime. It will also cease to operate if the vehicle fuel level drops too low.

During operation, power from the vehicle battery is used. The driving time should therefore be at least as long as the heating time. For short journey times, check the vehicle battery regularly and recharge if necessary.



To ensure efficient performance, briefly operate the auxiliary heater once a month.

Control units

The timer or remote control unit turns the system on and off, and is used to programme specific departure times.

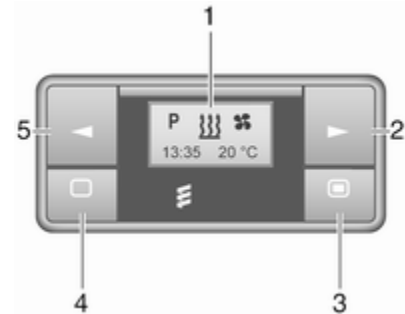
Timer (Type A)



- 1 Display** : Displays preset, current time or preset time, temperature, ,  and 
- 2 ►** : Adjusts values up
- 3 ■** : Long press: switch heater on, short press: turns display on or confirms selection

- 4 ◀ : Adjusts values down
- 5 □ : Long press: switch heater off, short press: turns display on or exit menu

Remote control (Type A)



- 1 Display : Displays preset, current time or preset time, temperature, ♣, ☹, ☺, ☼ and ⚡
- 2 ■ : Long press: switch heater on, short press: turns display on or confirms selection
- 3 ▶ : Adjusts values up

- 4 □ : Long press: switch heater off, short press: turns display on or exit menu

- 5 ◀ : Adjusts values down

If no buttons are pressed within ten seconds the display automatically turns off.

Remote control (Type A) fault displays

- INIT : automatic detection – wait until automatic detection is finished
- NO SIGNAL : no signal – check heater fuse
- ♣ : poor signal – move closer
- ☹ : battery low – replace battery
- ☺ : heater fault – consult workshop
- Add, AddE : system in learning mode

Teach remote control (Type A)

If the vehicle battery is reconnected, the LED in the instrument panel button illuminates and the system









configures the remote control menu automatically. If the LED flashes, select **Add** or **AddE** and confirm.

Additional remote control units may also be configured. Press the button until LED flashes, switch on the remote control, select **Add** and confirm.

AddE teaches the current remote control unit exclusively and blocks all previously configured units. **Add** teaches up to four remote control units, but only one unit can operate the system at any one time.

Remote control (Type B)



- 1 Display** : Displays preset, current time or preset time, temperature, , , ,  and 
- 2 ►** : Adjusts values up
- 3** : Switch heater off, or press **OFF**  and **OFF** simultaneously to confirm selection
- 4 ** : Switch heater on, or press  and **OFF** simultaneously to confirm selection
- 5 ◀** : Adjusts values down



If no buttons are pressed within 30 seconds the display automatically turns off.

Warning

When refuelling, switch off the remote control unit as well as the heater!

The remote control has a maximum range of 1000 m. The range may be reduced due to environmental conditions and as the battery becomes weaker.

Remote control (Type B) fault displays

-  : poor signal – adjust position
- FAIL** : error during signal transmission – move closer or check heater fuse
-  : battery low – replace battery

Teach remote control (Type B)

Up to four additional remote control units may also be configured. During additional teaching processes, the oldest transmitter will be deleted each time.

Remove the heater fuse for 5 seconds, then refit the fuse. Within 2–6 seconds press **OFF** for 1 second. Teaching is completed.

If the remote has not been used for a long period, press the **OFF** button 6 times at intervals of 2 seconds, then press and hold for another 2 seconds, then wait 2 minutes.

Manual control



Depending on version, the auxiliary heater can also be switched on for the last duration time or the default duration 30 minutes, or cut-off immediately, using the button on the instrument panel. The LED in the button confirms operation.

Battery replacement

Replace the battery when the range of the remote control is reduced or when the battery charge symbol flashes.

Open the cover and replace the battery (Type A: CR 2430, Type B: 2CR 11108, or equivalent), ensuring the new battery is correctly installed with the positive (+) side facing the positive terminals. Replace the cover securely.



Dispose of old batteries in accordance with environmental regulations.







Batteries do not belong in household waste. They must be disposed of at an appropriate recycling collection point.

Operation (Type A)



Heating



Select  in the menu bar and press  to confirm. The predetermined heating duration, e.g. **L 30**, flashes in the display. The factory setting is 30 minutes.

Adjust the heating duration using  or  and confirm. The value can be set from 10 to 120 minutes. Due to the power consumption, note the heating duration.

To switch off, select  in the menu bar again and press .

Ventilation





Select  in the menu bar and press  to confirm.

Adjust the ventilation duration using  or  and confirm. The value can be set from 10 to 120 minutes. Due to the power consumption, note the heating duration.

To switch off, select  in the menu bar again and press .

Programming P

Up to three preset departure times can be programmed, either during one day or over one week.

- Select **P** in the menu bar and press  to confirm.
- Select desired preset memory number **P1**, **P2** or **P3** and confirm.
- Select  and confirm.
- Select weekday or weekday group and confirm.
- Select hour and confirm.
- Select minutes and confirm.
- Select  or  and confirm.
- Select ECO or HIGH and confirm.
- Select duration and confirm.
- Press  to exit.

Repeat the procedure to programme the other preset memory numbers if required.

To activate a desired preset memory number select **P1**, **P2** or **P3**, then select On and confirm.

When a program is activated **P** and **W** will be displayed together.

To deactivate a preset memory, select **P1**, **P2** or **P3**, then select Off and confirm.

Heating stops automatically 5 minutes after the programmed departure time.

Notice

The remote control system features a temperature sensor which calculates the runtime according to the ambient temperature and the desired heating level (ECO or HIGH). The system starts automatically between 5 and 60 minutes prior to the programmed departure time.

Set time and weekday ☺

If the vehicle battery is disconnected or its voltage is too low, the unit will need to be reset.

- Select **W** in the menu bar and confirm.
- Select ☺ in the menu bar and confirm.
- Adjust using ◀ or ▶ to change the hour and confirm.
- Adjust using ◀ or ▶ to change the minutes and confirm.
- Press □ to exit.
- Select **W** in the menu bar and confirm.
- Select **Mo** in the menu bar and confirm.
- Adjust using ◀ or ▶ to change the weekday and confirm.
- Press □ to exit.

Heating level

The preferred heating level for programmed departure times can be set to either ECO or HIGH.

- Select **W** in the menu bar and confirm.
- Select ECO or HIGH and confirm.
- Press □ to exit.

Operation (Type B)

Heating **W** or Ventilation **V**

Select the operating mode **W** or **V**, if necessary.

- Press ▶ three times.
- Press **W** and **OFF** simultaneously, **W** or **V** flashes.
- Adjust using ◀ or ▶ to select **W** or **V**.
- Press **W** and **OFF** simultaneously to confirm.

To switch on, press **W** for 1 second. The predetermined heating duration, e.g. **30**, is displayed. The factory setting is 30 minutes.

The heating duration can be set in increments of 10 minutes. Due to the power consumption, note the heating duration.

- Press ▶ four times.
- Press **W** and **OFF** simultaneously, **W/V** flashes.
- Adjust using ◀ or ▶ to select the desired heating duration.
- Press **W** and **OFF** simultaneously to confirm.

To switch off, press **OFF**.

Programming

The system calculates the operating time of the heater depending on the temperature inside the vehicle.

- Press **◀** twice.
- Press **⏸** and **OFF** simultaneously,  flashes.
- Adjust using **◀** or **▶** to select the departure time.
- Press **⏸** and **OFF** simultaneously to confirm.

To switch on, press **⏸** for one second, **HTM** is displayed.

Heating stops automatically after the programmed departure time, or can be manually switched off.

- Press **◀** twice.
- Press **OFF** for 1 second, **HTM** goes out.

Set time

If the vehicle battery is disconnected or its voltage is too low, the time will need to be reset.

- Press **▶** once.
- Press **⏸** and **OFF** simultaneously,  flashes.
- Adjust using **◀** or **▶** to set the time.
- Press **⏸** and **OFF** simultaneously to confirm.

Heating level

The preferred heating level for programmed departure times can be set to between C1 and C5.

- Press **◀** three times.
- Press **⏸** and **OFF** simultaneously,  flashes.
- Adjust using **◀** or **▶** to set the heating level.
- Press **⏸** and **OFF** simultaneously to confirm.

To display the passenger compartment temperature, press **▶** twice.

Air vents

Adjustable air vents

At least one air vent must be open while cooling is on in order to prevent the evaporator from icing up due to lack of air movement.

Centre air vents



Direct the flow of air by tilting and swivelling the slats.

To close the vent, swivel the slat towards the outside of the vehicle.

Side air vents



Direct the flow of air by tilting and swivelling the slats.

To close the vent, swivel the slat towards the outside of the vehicle.

Warning

Do not attach any objects to the slats of the air vents. Risk of damage and injury in the event of an accident.

Combi



Adjustable air vents may be located in the roof frame. To open, press air vent. Hold air vent and turn it to the required position to direct the airflow.

Bus



Adjustable air vents may be located in the roof frame above the seats. Turn adjuster to increase / decrease airflow to the appropriate seat.

Fixed air vents

Additional air vents are located beneath the windscreen and door windows and in the foot wells.

Glovebox cooler

The air conditioning system can also keep the contents of the glovebox cool.

Maintenance

Air intake

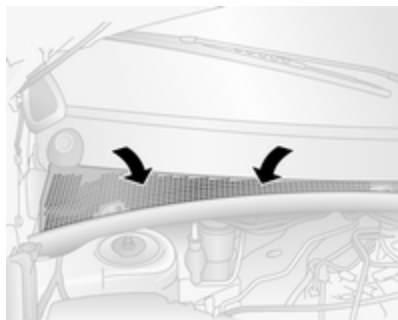

The air intake in front of the windscreen in the engine compartment must be kept clear to allow air intake. Remove any leaves, dirt or snow.

Air conditioning regular operation

In order to ensure continuously efficient performance, cooling must be operated for a few minutes once a month, irrespective of the weather and time of year. Operation with cooling is not possible when outside temperature is too low.

Service

For optimal cooling performance, it is recommended to annually check the climate control system, starting 3 years after initial vehicle registration, including:

- functionality and pressure test
- heating functionality
- leakage check
- check of drive belts
- cleaning of condenser and evaporator drainage
- performance check

Notice

Refrigerant R-134a may contain fluorinated greenhouse gases with a global warming potential of 1430.

Front air conditioning system is filled with 0.58 kg and has a CO₂ equivalent of 0.83 tonnes, the front and rear air conditioning system in Combi variants is filled with 1.1 kg and has a CO₂ equivalent of 1.57 tonnes and the front and rear air conditioning system in Bus variants is filled with 1.7 kg and has a CO₂ equivalent of 2.43 tonnes.

Depending on vehicle, information regarding air conditioning refrigerant appears on a label located in the engine compartment.

Driving and operating

Driving hints	224
Driving economically	224
Control of the vehicle	224
Steering	224
Starting and operating	225
New vehicle running-in	225
Ignition switch positions	225
Starting the engine	226
Idle speed control	227
Overrun cut-off	227
Stop-start system	227
Parking	230
Air suspension	230
Engine exhaust	232
Diesel particle filter	232
Catalytic converter	233
AdBlue	233
Manual transmission	240
Manual transmission automa-	
ted	240
Transmission display	240
Starting the engine	241
Selector lever	241

Manual mode	242
Electronic driving programmes	242
Fault	243
Interruption of power supply	243
Brakes	243
Antilock brake system	243
Parking brake	244
Brake assist	245
Hill start assist	245
Ride control systems	246
Traction Control system	246
Electronic Stability Control	247
Limited-slip rear axle	248
Driver assistance systems	248
Cruise control	248
Speed limiter	250
Active emergency braking	252
Parking assist	254
Side blind spot alert	256
Rear view camera	258
Lane departure warning	260
Fuel	261
Fuel for diesel engines	261
Refuelling	262
Trailer hitch	264
General information	264
Driving characteristics and	
towing tips	264
Trailer towing	264

Towing equipment	265
Trailer stability assist	265
Auxiliary features	265
Power take-off	265

Driving hints

Driving economically

ECO mode

ECO mode is a function that optimises fuel consumption. It affects engine power and torque, acceleration, gear shift indication, heating, air conditioning and electrical consumers.

Activation



Press **ECO**. When activated **ECO** appears in the Driver Information Centre.

During driving, it is possible to temporarily disable ECO mode, e.g. to increase engine performance, by depressing the accelerator pedal firmly.

ECO mode is reactivated when pressure is reduced on the accelerator pedal.

Deactivation

Press **ECO** again. **ECO** disappears in the Driver Information Centre.

Driver Information Centre ⇨ 104.

Control of the vehicle

Never coast with engine not running (except during Autostop)

Many systems will not function in this situation (e.g. brake servo unit, power steering). Driving in this manner is a danger to yourself and others. All systems function during an Autostop, but there may be a controlled reduction in power steering assist and vehicle speed is reduced.

Stop-start system ⇨ 227.

Pedals

To ensure the pedal travel is uninhibited, there must be no mats in the area of the pedals.

Use only floor mats which fit properly and are fixed by the retainers on the driver's side.

Driving downhill

Engage a gear when driving downhill to ensure that sufficient brake pressure is available.

Steering

If power steering assist is lost because the engine stops or due to a system malfunction, the vehicle can be steered but may require increased effort.

Caution

Vehicles equipped with hydraulic power steering:

If the steering wheel is turned until it reaches the end of its travel, and is held in that position for more

than 15 seconds, damage may occur to the power steering system and there may be loss of power steering assist.

Starting and operating

New vehicle running-in

Do not brake unnecessarily hard for the first few journeys and after new disc brake pads have been fitted.

During the first drive, smoke may occur because of wax and oil evaporating off the exhaust system. Park the vehicle in the open for a while after the first drive and avoid inhaling the fumes.

Limit the engine speed to 2,500/min for the first 900 miles.

During the running-in period fuel and engine oil consumption may be higher and the cleaning process of the diesel particle filter may take place more often. Autostop may be inhibited to allow for charging the vehicle battery.

Stop-start system ↗ 227.

Diesel particle filter ↗ 232.

Ignition switch positions

Turn key:

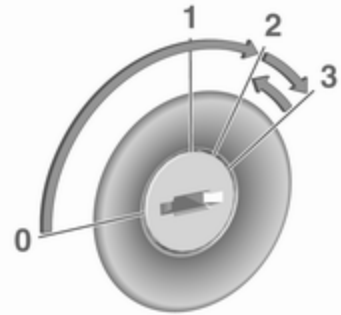

- 0 : ignition off: Some functions remain active until key is removed or driver's door is opened, provided the ignition was on previously
- 1 : accessory power mode: Steering wheel lock released, some electrical functions are operable, ignition is off
- 2 : ignition is on, diesel engine is preheating. Control indicators illuminate and most electrical functions are operable
- 3 : engine start: Release key after starting procedure begins

Steering wheel lock

Remove key from ignition switch and turn steering wheel until it engages.

⚠ Danger

Never remove the key from ignition switch during driving as this will cause steering wheel lock.

Starting the engine

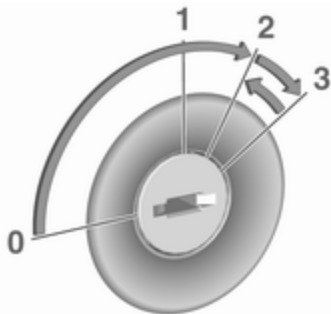

Manual transmission: operate clutch.

Manual transmission automated:
operate brake; transmission
automatically shifts to **N**.

Do not accelerate.

Turn the key to position **2** for preheating, and hold until control indicator  extinguishes from the Driver Information Centre.

Notice

Depending on vehicle, if a gear is engaged during preheating, a message may appear in the Driver Information Centre (DIC)  104 indicating that the clutch pedal must be depressed when starting the engine.

Turn key to position **3** and release.

The increased engine speed automatically returns to normal idling speed as the engine temperature rises.

Start attempts should not last longer than 15 seconds. If engine does not start, wait 15 seconds before repeating starting procedure. If necessary, depress accelerator before repeating starting procedure.

Notice

Rear-wheel drive with twin rear wheels and front-wheel drive: When starting on a level surface with an

unladen vehicle, it is recommended that second gear is selected when starting off.

Before restarting or to switch off the engine, turn key back to **0**.

During an Autostop, the engine can be started by depressing the clutch pedal.

Stop-start system  227.

Turbo engine warm-up



Upon start-up, engine available torque may be limited for a short time, especially when the engine temperature is cold. The limitation is to allow the lubrication system to fully protect the engine.

Idle speed control



To increase the idle speed press the switch. After a few seconds the function will be activated.

The function will be deactivated when:

- The clutch pedal is depressed.
- The accelerator pedal is depressed.
- The manual transmission automated is not in **N** (neutral).
- Vehicle speed is above 0 mph.
- Control indicator ,  or **STOP** illuminate in the instrument cluster.

To increase or decrease the fast idle speed rate, consult a workshop.

Notice

When the fast idle function is activated, the stop-start system is automatically deactivated.

Stop-start system ⇨ 227.

Overrun cut-off

The fuel supply is automatically cut off during overrun, i.e. when the vehicle is driven with a gear engaged but accelerator pedal is released.

Depending on driving conditions, the overrun cut-off may be deactivated.

Stop-start system

The stop-start system helps to save fuel and to reduce the exhaust emissions. When conditions allow, it switches off the engine as soon as the vehicle is at a low speed or at a standstill, e.g. at a traffic light or in a traffic jam.

It restarts the engine automatically as soon as the clutch pedal is depressed (manual transmission) or the brake pedal is released (manual transmission automated).

A vehicle battery sensor ensures that an Autostop is only performed if the vehicle battery is sufficiently charged for a restart.

Activation

The stop-start system is available as soon as the engine is started, the vehicle starts-off and the conditions as stated below in this section are fulfilled.

If the below conditions are not fulfilled, an Autostop is prohibited and control indicator  illuminates in the instrument cluster ⇨ 102.

Deactivation



Deactivate the stop-start system manually by pressing (A)^{OFF}.

Deactivation is indicated when the LED in the button illuminates.

To reactivate, press (A) again. The LED extinguishes in the button. The system is reactivated automatically the next time the ignition is switched on.

Notice

When the fast idle function is activated, the stop-start system is automatically deactivated and cannot be reactivated by pressing (A). LED in button illuminates to

indicate deactivation and a corresponding message may appear in the Driver Information Centre ↪ 104.

Idle speed control ↪ 227.

Autostop

Manual transmission

If the vehicle is at low speed or standstill, activate an Autostop as follows:

- depress the clutch pedal
- move the selector lever to neutral
- release the clutch pedal

Control indicator (A) may flash if the clutch is not released sufficiently.

Manual transmission automated

If the vehicle is at a standstill, activate an Autostop as follows:

- selector lever in position **D**, **M** or **N**
- depress brake pedal firmly
- do not accelerate

The engine will be switched off while the ignition stays on if the required conditions are fulfilled.

An Autostop is indicated when (A) illuminates ↪ 102.

During an Autostop, the heating performance, power steering and brake performance will be maintained. Brake assist, however, is not available ↪ 245.

Notice

If you exit the vehicle while the engine is in an Autostop, a warning chime will sound as a reminder that the engine is on standby and has not been switched off.

Warning

Switch off engine and ignition before exiting the vehicle.

Conditions for an Autostop

The stop-start system checks if each of the following conditions is fulfilled, otherwise an Autostop will be inhibited and control indicator (A) will illuminate.

- the stop-start system is not manually deactivated
- the bonnet is fully closed

- the vehicle battery is sufficiently charged and in good condition
- the engine is warmed up
- the engine coolant temperature is not too high
- the ambient temperature is not too low
- the altitude is not too high
- the slope is not too steep
- the defrosting function is not activated
- the parking assist is not in operation
- the climate control system does not inhibit an Autostop
- the rear air conditioning system is not activated
- the brake vacuum is sufficient
- the self-cleaning function of the diesel particle filter is not active ⇨ 232
- the vehicle has moved since the last Autostop

Otherwise an Autostop will be inhibited.

An Autostop may become unavailable as the ambient temperature approaches freezing point.

Certain settings of the climate control system may also inhibit an Autostop. See "Climate control" chapter for further information ⇨ 207.

Immediately after motorway driving an Autostop may be inhibited.

New vehicle running-in ⇨ 225.

Vehicle battery discharge protection

To ensure reliable engine restarts, several vehicle battery discharge protection features are implemented as part of the stop-start system.

Restart of the engine by the driver

Manual transmission

With the selector lever in neutral, depress the clutch pedal to restart the engine.

Notice

If any gear is selected, the clutch pedal must be fully depressed to restart the engine.

If the engine does not restart first time, depress clutch pedal fully again.

Manual transmission automated

With the selector lever in position **D**, **M** or **N** and the parking brake released, release the brake pedal to restart the engine.

Engaging reverse gear or depressing the accelerator pedal may also restart the engine.

The control indicator  will extinguish in the instrument cluster when the engine is restarted. If certain conditions are not fulfilled, a restart will not take place. Start using the ignition key.

Starting the engine ⇨ 226.

Bus

The engine is restarted automatically when operating the power sliding door switch on the instrument panel during an Autostop.

Sliding door ⇨ 29.

Restart of the engine by the stop-start system

If one of the conditions for an Autostop is not fulfilled anymore or the vehicle starts to move, the engine may be restarted automatically by the stop-start system.

An automatic engine restart may not be possible if a door or the bonnet is open.

If an electrical accessory, e.g. a portable CD player, is connected to the power outlet, a brief power drop during restart might be noticeable.

If the Infotainment system is active, audio sound may briefly be reduced or interrupted during the restart.

Fault

If the LED illuminates in deactivation button (A)^{OFF} without first being pressed to deactivate the system, there is a fault in the stop-start system and it is deactivated. A corresponding message also appears in the Driver Information Centre ↷ 104.

Seek the assistance of a workshop.

Parking

⚠ Warning

- Do not park the vehicle on an easily ignitable surface. The high temperature of the exhaust system could ignite the surface.
- Always apply parking brake without pressing release button. Apply as firmly as possible on a downhill slope or uphill slope. Depress brake pedal at the same time to reduce operating force.
- Switch off the engine.
- If the vehicle is on a level surface or uphill slope, engage first gear. On an uphill slope, turn the front wheels away from the kerb.

If the vehicle is on a downhill slope, engage reverse gear. Turn the front wheels towards the kerb.

- Close the windows.
- Turn the ignition key to position 0 and remove it. Turn the steering wheel until the steering wheel lock is felt to engage.

Lock the vehicle ↷ 23 and activate the anti-theft locking system ↷ 34 and anti-theft alarm system ↷ 35.

Air suspension

Operates automatically when the vehicle is driven. The air suspension system constantly adjusts the ride height according to the vehicle load.

Caution

To ensure safe operation of the air suspension system, do not exceed the maximum permissible gross vehicle weight rating. Refer to identification plate ↷ 314 or the vehicle documents.

For further information on the air suspension system, refer to the operating instructions supplied.

Master switch

Caution

The air suspension system must be switched off when the vehicle is being towed, jump-started, raised off the ground or transported.

Do not switch off the air suspension system when driving.

Jump starting ⇨ 303.

Towing the vehicle ⇨ 305.



The master switch is located on the lower part of the right-hand door pillar, behind a trim panel.

Switch on to enable operation and adjustment of the air suspension system.

Switch off to put the vehicle into service mode.

Remote control



When increased ground clearance or improved vehicle access is required, the suspension can be raised or lowered using the remote control.

Caution

Ensure there is adequate clearance and that there are no obstructions when adjusting the suspension height.

The remote control unit is magnetic and may be fixed to any metal part of the vehicle or stored in its holder.

With the engine running, press the appropriate button for two seconds to adjust the suspension height. Indicator light will flash intermittently while height adjustment is in progress and illuminates when complete.



If the ignition is switched on with engine not running, the suspension height can only be lowered.

Notice

Handle with care, protect from moisture and high temperatures and avoid unnecessary operation.

Pre-programmed settings

Adjusts the suspension height to one of three pre-programmed positions.



-  : lowered position
-  : normal position
-  : raised position

Caution

If an obstacle is detected while raising or lowering, the suspension height is returned to the normal position after a delay. This does not guarantee damage-free operation. Ensuring sufficient clearance and freedom from obstacles is the responsibility of the driver.

Manual settings

Manual adjustment can only be performed when the vehicle is stationary.

Select by pressing  for 2 seconds, then  to raise, or  to lower.

To exit, press any of the pre-programmed buttons.

Notice

Obstacle detection is not available during manual adjustment.

When a certain low speed is exceeded or when the ignition is switched off, height adjustment is deactivated automatically and the suspension height is returned to the normal position.





Service mode

When the vehicle is stationary, press  for 5 seconds to put the vehicle into service mode. The indicator light will illuminate.

When service mode has been activated, the air suspension master switch must be turned off.

To exit service mode, press  again for 5 seconds.

Fault

If a fault is detected,  will flash intermittently. If service mode has been activated and there is a fault, ,  and  will flash simultaneously.

Have the cause of the fault remedied by a workshop.

Engine exhaust

⚠ Danger

Engine exhaust gases contain poisonous carbon monoxide, which is colourless and odourless and could be fatal if inhaled.

If exhaust gases enter the interior of the vehicle, open the windows. Have the cause of the fault rectified by a workshop.

Avoid driving with an open load compartment, otherwise exhaust gases could enter the vehicle.

Diesel particle filter

The diesel particle filter system filters soot particles out of the exhaust gases. The system includes a self-cleaning function that runs automatically during driving without any notification.

The filter is cleaned by periodically burning off the soot particles at high temperature. This process takes place automatically under set driving

conditions. Autostop is not available and fuel consumption may be higher during this period. The emission of smells and smoke during this process is normal.

Under certain driving conditions, e.g. short distances, the system cannot clean itself automatically.

If cleaning of the filter is required and if previous driving conditions did not enable automatic cleaning, it will be indicated by illumination of control indicator  98. Seek the assistance of a workshop immediately.

Caution

If the cleaning process is interrupted, there is a risk of provoking severe engine damage.

Cleaning takes place quickest at high engine speeds and loads.

Catalytic converter



The catalytic converter reduces the amount of harmful substances in the exhaust gases.

Caution

Fuel grades other than those listed on page 261 could damage the catalytic converter or electronic components.

Unburnt fuel will overheat and damage the catalytic converter. Therefore avoid excessive use of the starter, running the fuel tank dry and starting the engine by pushing or towing.

In the event of misfiring, uneven engine running, a reduction in engine performance or other unusual problems, have the cause of the fault rectified by a workshop as soon as possible. In an emergency, driving can be continued for a short period, keeping vehicle speed and engine speed low.

If control indicator  flashes, the permitted emission limits may be exceeded. Lift your foot off the accelerator until  stops flashing and is steadily illuminated. Contact a workshop immediately.

Malfunction indicator light  98.

AdBlue

General information

The selective catalytic reduction is a method to substantially reduce the nitrogen oxides in the exhaust emission. This is achieved by injecting a Diesel Exhaust Fluid (DEF) into the exhaust system.

The designation of this fluid is AdBlue®. It is a non-toxic, non-flammable, colourless and odourless fluid which consists of 32% urea and 68% water.

Warning

Avoid contact of your eyes or skin with AdBlue.

In case of eye or skin contact, rinse off with water.

Caution

Avoid contact of the paintwork with AdBlue.

In case of contact, rinse off with water.

AdBlue freezes at a temperature of approx. -11°C . As the vehicle is equipped with an AdBlue pre-heater, the emissions reduction at low temperatures is ensured. The AdBlue pre-heater works automatically.

Level warnings

The AdBlue consumption is approx. 3.5 l per 600 miles (810 mpg) and depends on the driving behaviour.

AdBlue gauge ↷ 92.

Level warnings in the Driver Information Centre

If the AdBlue level falls below a certain value, a level warning will be displayed in the Driver Information Centre ↷ 104.



Additionally, control indicator  illuminates continuously together with a warning chime.

Refill the AdBlue tank as soon as possible. Refer to "Refilling AdBlue" below.

If AdBlue is not refilled within a certain distance, further level warnings are displayed in the Driver Information Centre depending on the current AdBlue level.



Engine restarts prevented

Subsequent requests to refill AdBlue and finally the announcement that an engine restart will be prevented are displayed in the Driver Information Centre.

Notice

These restrictions are a legal requirement.

Warning stages: level warnings, engine restarts prevented

1. The warning message **TOP UP ADBLUE** is displayed after the ignition is switched on and the range is less than 1500 miles. Driving is possible without any restrictions. Refill the AdBlue tank soon.
2.  illuminates and the warning message **TOP UP ADBLUE** is displayed after the ignition is switched on and the range is less than 930 or 745 miles. Refill the AdBlue tank soon.
3.  illuminates and the warning message **XXXX KM FAILURE TOP UP ADBLUE** is displayed

after the ignition is switched on and the range is less than 620 or 500 miles. The message is repeated every 62 miles. When the range is less than 124 miles the message is repeated every 31 miles.

Vehicle speed may be limited to 12 mph after switching the engine off and on again until the range is reduced to 0 miles.

Refill the tank completely or with a volume of at least 10 l of AdBlue (depending on AdBlue consumption) as soon as possible.

4.  illuminates during driving with warning message **OKM FAILURE TOP UP ADBLUE**:



The engine cannot be restarted after switching off the ignition.

To allow the engine to be restarted, refill the tank completely or with a volume of at least 10 l of AdBlue (depending on AdBlue consumption) as soon as possible.

Illumination of control indicator  may be accompanied by a warning chime.

Warning chimes ⇨ 106.

High emission warnings

If the exhaust emission rises above a certain value, warnings similar to the range warnings as described above will be displayed in the Driver Information Centre. Control indicator  illuminates continuously together with  ⇨ 98 and a warning chime.

Requests to have the exhaust system checked and finally the announcement that an engine restart will be prevented are displayed in the Driver Information Centre.

Notice

These restrictions are a legal requirement.



Seek the assistance of a workshop as soon as possible.

Warning stages: high emission warnings

1.  and  illuminate with warning message **Check Anti-Pollution System**.

Fault in the system that may result in a loss of engine power.

Seek the assistance of a workshop as soon as possible.

2.  and  illuminate with warning message **xxxKM failure antipollution**.

Indicates that in less than 620 or 500 miles an engine restart will be prohibited after switching off the ignition. This warning message will be repeated every 62 miles. When the range is less than 124 miles the message is repeated every 31 miles.



Vehicle speed may be limited to 12 mph after switching the engine off and on again until the range is reduced to 0 miles.

Seek the assistance of a workshop as soon as possible.

3.  and  illuminate with warning message **OKM failure antipollution**.

The engine cannot be restarted after switching off the ignition.



Seek the assistance of a workshop.

Illumination of control indicators  and  may be accompanied by a warning chime.

Warning chimes ⇨ 106.

Version without level warnings in the Driver Information Centre



When the AdBlue gauge shows the level is very low, control indicator  first illuminates continuously, then as AdBlue level drops to a certain amount  flashes for a few seconds then illuminates continuously.

Refill the AdBlue tank as soon as possible. Refer to "Refilling AdBlue" below.

Driving is possible without any restrictions.

Notice

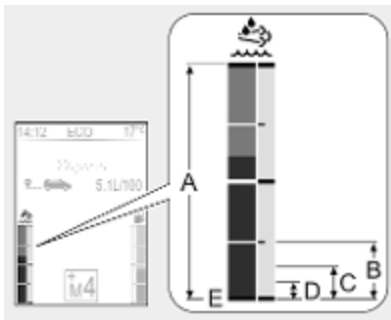

These restrictions are a legal requirement.

Warning stages: level warnings, engine power loss





1. Range **A**. No control indicator:
Driving is possible without any restrictions.
2. Range **B**. Control indicator  illuminates:

Refill the AdBlue tank as soon as possible.

3. Range **C**. Control indicator  flashes for a few seconds each time the ignition is switched on, then illuminates continuously:
Refill the AdBlue tank as soon as possible.
4. Range **D**. Control indicator  flashes for a few seconds each time the ignition is switched on then illuminates continuously, accompanied by a warning chime:
Loss of engine power.
Refill the tank completely or with a volume of at least 10 l of AdBlue (depending on AdBlue consumption) as soon as possible.
5. Range **E**. Tank is empty and  flashes accompanied by warning chimes:
Vehicle speed will be limited to 12 mph after switching the engine off and on again.
Refill the tank completely or with a volume of at least 10 l of AdBlue

(depending on AdBlue consumption) as soon as possible.





High emission warnings

If the exhaust emission rises above a certain value, control indicator  illuminates together with  ⇨ 98. Consult a workshop as soon as possible.

Notice

These restrictions are a legal requirement.

Warning stages: high emission warnings

-  and  illuminate:
Fault in the system.
Seek the assistance of a workshop as soon as possible.
-  and  flash when the engine is started then illuminate continuously:
Fault in the system resulting in a loss of engine power.



Seek the assistance of a workshop as soon as possible.

-  and  flash:

Fault in the system.

Vehicle speed will be limited to 12 mph after switching the engine off and on again.

Seek the assistance of a workshop as soon as possible.

Illumination of control indicators  and  may be accompanied by a warning chime.

Warning chimes ⇨ 106.

Refilling AdBlue



Caution

Only use AdBlue that complies with European standards DIN 70 070 and ISO 22241-1.

Do not use additives.

Do not dilute AdBlue.

Otherwise the selective catalytic reduction system could be damaged.

Notice

If AdBlue must be refilled at very low temperatures, the refilling of AdBlue may not be detected by the system. In this case, park the vehicle in a space with a higher ambient temperature until AdBlue is liquefied.

Notice

If engine starting is prohibited due to low AdBlue level, we recommend refilling the tank completely or with a

volume of at least 10 l of AdBlue (depending on AdBlue consumption).

Avoid minor top-ups (e.g. less than 10 l), otherwise the system may not detect a refill.

Notice

When unscrewing the protective cap from the filler neck, ammonia fumes may emerge. Do not inhale as the fumes have a pungent smell. The fumes are not harmful by inhalation.

The vehicle must be parked on a level surface.

The filler neck for AdBlue is located behind the filler flap located on the right-hand side of the vehicle.

The filler flap can only be opened if the vehicle is unlocked and the right-hand door is opened.

⚠ Danger

Vehicles with stop-start system: The engine must be switched off and the ignition key removed, to

avoid risk of engine being restarted automatically by the system.

Capacities ⇨ 315.

Filling station

⚠ Danger

Follow the operating and safety instructions of the filling station when refilling AdBlue.

1. Switch off engine and remove key from ignition switch.
2. Open right-hand door and pull fuel filler flap to open.



3. Unscrew blue protective cap anticlockwise from the filler neck.
4. Fully insert the pump nozzle into the filler neck and switch it on.
5. When refilling is complete, mount the protective cap and turn clockwise until it engages.
6. Close filler flap and right-hand door.

AdBlue canister

Notice

Only use the designated AdBlue canisters for refilling, to prevent a topping-up of too much AdBlue.

Additionally, the fumes in the tank are captured in the canister and do not emerge.

Notice

Since AdBlue has a limited durability, check the date of expiry before refilling.

1. Switch off engine and remove key from ignition switch.
2. Open right-hand door and pull fuel filler flap to open.



3. Unscrew blue protective cap anticlockwise from the filler neck.
4. Open AdBlue canister.

5. Mount one end of the hose on the canister and screw the other end on the filler neck.
6. Lift the canister until it is empty, or until the flow from the canister has stopped. This can take up to five minutes.
7. Place the canister on the ground to empty the hose, wait 15 seconds.
8. Unscrew the hose from the filler neck.
9. Mount the protective cap and turn clockwise until it engages.
10. Close filler flap and right-hand door.

Notice

Dispose of AdBlue canister according to environmental requirements. Hose can be reused after flushing with clear water before AdBlue dries out.

Notice

Allow the vehicle to idle for at least ten seconds to allow the system to detect the AdBlue refill.

Failure to observe this procedure will result in the system only recognising the AdBlue refill after approx. 20 minutes of driving.



If the AdBlue refill is detected successfully, AdBlue level warnings will disappear.

If the AdBlue refill is not detected some time after running the engine, seek the assistance of a workshop.

Filler cap

Only use genuine filler caps. AdBlue tank has a special filler cap.

Fault

If the system detects an operating fault, control indicator  illuminates together with  and a warning chime. Seek the assistance of a workshop immediately.

Depending on version, a corresponding message may also appear in the Driver Information Centre  104.

Manual transmission



To engage reverse, with the vehicle stationary depress the clutch pedal, pull up the collar on the selector lever and engage the gear.

If the gear does not engage, set the lever to neutral, release the clutch pedal and depress again, then repeat gear selection.

Do not slip the clutch unnecessarily.

When operating, depress the clutch pedal completely. Do not use the pedal as a foot rest.

Caution

It is inadvisable to drive with hand resting on the selector lever.

Gear shifting ⇨ 99.

Stop-start system ⇨ 227.

Manual transmission automated

The manual transmission automated (MTA) permits manual (manual mode) or automatic gear shifting (automatic mode), both with automatic clutch control.

Transmission display

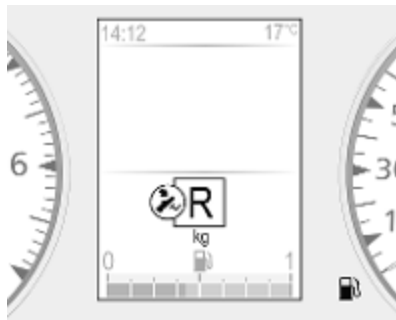

Shows the mode and current gear.

Starting the engine

Depress the brake pedal when starting the engine. If the brake pedal is not depressed,  illuminates in the transmission display and the engine cannot be started.

When the brake pedal is depressed, the transmission automatically shifts to **N** (neutral). "N" appears in the transmission display and the engine can be started. There may be a slight delay.

Selector lever

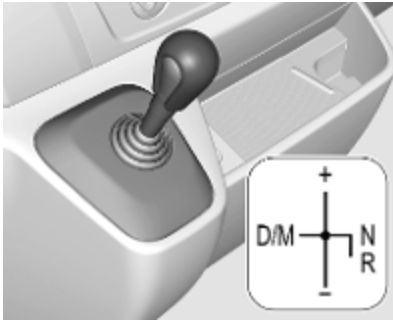

Always move the selector lever in the appropriate direction as far as it will go. Upon release, it automatically returns to the centre position.

N : neutral

D/M : switch between automatic and manual mode

The transmission display shows "D" when in automatic mode.

R : reverse gear

Engage only when vehicle is stationary. The transmission display shows "R" when reverse gear is engaged.

+ : shift to a higher gear.

- : shift to a lower gear.

Starting off

When the engine is started, the transmission is in automatic mode. Depress the brake pedal and move the selector lever towards **+** to engage first gear.

If **R** is selected, reverse gear is engaged. The vehicle starts to move when the brake pedal is released. To

start off quickly, release the brake pedal and accelerate immediately after engaging a gear.

In automatic mode the transmission shifts to other gears automatically, dependent on driving conditions.

To engage manual mode, move the selector lever towards **D/M**. The current gear will appear in the transmission display.

To engage first gear, depress brake pedal and move selector lever towards **+** or **-**. Shift to a higher or lower gear by moving selector lever to **+** or **-**. Gears can be skipped by moving the selector lever repeatedly at short intervals.

Stopping the vehicle

In automatic or manual mode, first gear is engaged and the clutch is released when the vehicle is stopped. In **R**, reverse gear remains engaged.

When stopping on gradients, engage parking brake or depress the brake pedal. To prevent overheating of the clutch, an intermittent audible

warning may sound as a signal to depress the brake pedal or apply the parking brake.

Switch off engine if stopping for a lengthy period, e.g. in traffic jams.

When the vehicle is parked and the driver's door is opened, a warning chime will sound if neutral is not selected or the brake pedal has not been depressed.

Engine braking

Automatic mode

When driving downhill, the manual transmission automated does not shift into higher gears until a fairly high engine speed has been reached. It shifts down in good time when braking.

Manual mode

To utilise the engine braking effect, select a lower gear in good time when driving downhill.

Rocking the vehicle

Rocking the vehicle is only permissible if the vehicle is stuck in sand, mud, snow or a hole. Move the selector lever between **R** and **D/M** (or between **+** and **-**) in a repeat pattern, while applying light pressure to the accelerator pedal. Do not race the engine and avoid sudden acceleration.

Parking

Apply the parking brake. The most recently engaged gear (see transmission display) remains engaged. With **N**, no gear is engaged.

When the ignition is switched off, the transmission no longer responds to movement of the selector lever.

If the ignition is not switched off, or the parking brake has not been applied, a warning chime will sound upon opening the driver's door.

Manual mode

If a higher gear is selected when the engine speed is too low, or a lower gear when the speed is too high, the

shift is not executed. This prevents the engine from running at too low or too high an engine speed.

If engine speed is too low, the transmission automatically shifts to a lower gear.

If engine speed is too high, the transmission only switches to a higher gear via kickdown.

Electronic driving programmes

Laden mode kg



shift is not executed. This prevents the engine from running at too low or too high an engine speed.

It is possible to use the Laden mode in both manual and automatic modes. In both cases, the gearshifting patterns are adapted automatically for carrying an increased payload.

Activation

Press **kg**. Control indicator **kg** is shown in the transmission display. The transmission will then select optimized gearshift patterns.

Deactivation

The Laden mode is switched off by:

- pressing **kg** again
- turning off the ignition

Kickdown

If the accelerator pedal is pressed past the pressure point, the transmission shifts to a lower gear depending on engine speed. Full engine power is available for acceleration.

If engine speed is too high the transmission switches to a higher gear, even in manual mode. Without kickdown this automatic shift is not effected in manual mode.

Fault

In the event of a fault, control indicator  is shown in the transmission display. Continued driving is possible provided the vehicle is driven with care and anticipation.

Have the cause of the fault remedied by a workshop.

Interruption of power supply

The clutch is not disengaged if there is an interruption of the power supply when a gear is engaged. The vehicle cannot move.

If the vehicle battery is discharged, start the vehicle using jump leads ⇨ 303.

If the cause of the fault is not a discharged vehicle battery, seek the assistance of a workshop.

If neutral cannot be selected, the vehicle must only be towed with the drive wheels raised off the ground ⇨ 305.

Towing the vehicle ⇨ 305.

Brakes

The brake system comprises two independent brake circuits.

If a brake circuit fails, the vehicle can still be braked using the other brake circuit. However, braking effect is achieved only when you depress the brake pedal firmly. You need to use considerably more force for this. The braking distance is extended. Seek the assistance of a workshop before continuing your journey.

When the engine is not running, the support of the brake servo unit disappears once the brake pedal has been depressed once or twice. Braking effect is not reduced, but braking requires significantly greater force. It is especially important to bear this in mind when being towed.

Control indicator  ⇨ 99.

Antilock brake system

Antilock brake system (ABS) prevents the wheels from locking.

ABS starts to regulate brake pressure as soon as a wheel shows a tendency to lock. The vehicle remains steerable, even during hard braking.

ABS control is made apparent through a pulse in the brake pedal and the noise of the regulation process.

For optimum braking, keep the brake pedal fully depressed throughout the braking process, despite the fact that the pedal is pulsating. Do not reduce the pressure on the pedal.

Control indicator (ABS) ⇨ 99.



Fault

If control indicators (ABS) and  illuminate with a message in the Driver Information Centre, there is a fault in the ABS. The brake system remains operational but without ABS regulation.

Warning

If there is a fault in the ABS, the wheels may be liable to lock due to braking that is heavier than

normal. The advantages of ABS are no longer available. During hard braking, the vehicle can no longer be steered and may swerve.

If control indicators (ABS),  and  and STOP illuminate, the ABS and ESC are deactivated and a message is shown in the Driver Information Centre.

Have the cause of the fault remedied by a workshop.

Parking brake

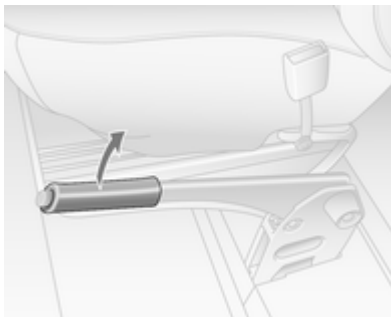

Warning

Always apply parking brake firmly without operating the release button, and apply as firmly as possible on a downhill or uphill slope.

To release the parking brake, pull the lever up slightly, press the release button and fully lower the lever.

To reduce the operating forces of the parking brake, depress the brake pedal at the same time.

Control indicator (P) ⇨ 99.

Parking ⇨ 230.

Retractable parking brake

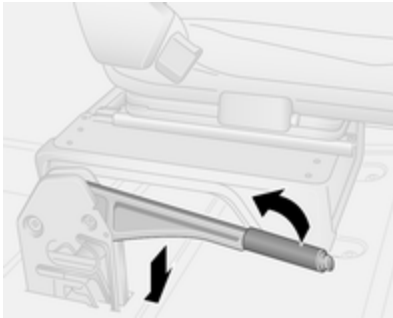

Depending on vehicle, the parking brake lever retracts to the horizontal position even with the parking brake applied.

To release the parking brake, press the release button and pull the lever up slightly, then return the lever to the horizontal position.

To apply the parking brake, pull the lever up then release it. The lever returns to the horizontal position.

Brake assist

If the brake pedal is depressed quickly and forcefully, maximum brake force is automatically applied (full braking).

Maintain steady pressure on the brake pedal for as long as full braking is required. Maximum brake force is automatically reduced when the brake pedal is released.

Brake assist is not available during an Autostop.

Stop-start system ⇨ 227.

Hill start assist

The system helps prevent unintended movement when driving away on inclines, depending on the steepness.

When releasing the brake pedal after stopping on an incline (with the selector lever in a forward gear or reverse gear), the brakes remain on for a further 2 seconds. The brakes release automatically as soon as the vehicle begins to accelerate.

Caution

The hill start assist cannot completely prevent vehicle movement in all situations (extremely steep gradients, etc.).

If necessary, depress the brake pedal to prevent the vehicle from rolling backwards.

The hill start assist is not active during an Autostop.

Stop-start system ⇨ 227.

Ride control systems

Traction Control system

The traction control system is a component part of the Electronic Stability Control (ESC) which improves driving stability when necessary, regardless of the type of road surface or tyre grip, by preventing the drive wheels from spinning.

As soon as the drive wheels start to spin, engine output is reduced and the wheel spinning the most is braked individually. This considerably improves the driving stability of the vehicle on slippery road surfaces.

Traction control system is operational as soon as the ignition is switched on and control indicator  extinguishes in the instrument cluster.

When traction control system is active  flashes.

Warning

Do not let this special safety feature tempt you into taking risks when driving.

Adapt speed to the road conditions.

Control indicator  \diamond 100.

Trailer stability assist \diamond 265.

Enhanced traction function





If necessary, in the event of soft ground, mud or snow-covered road surfaces, the traction control system can be deactivated to enhance traction:

Press  .



A message appears in the Driver Information Centre.

When vehicle speed reaches 30 mph, the system switches automatically to standard traction control system operation. A message appears in the Driver Information Centre.

Traction control system is reactivated by pressing   again.

A message appears in the Driver Information Centre.

Fault

If the system detects a fault, control indicator  \diamond 100 illuminates together with  \diamond 98 in the instrument cluster and a corresponding message appears in the Driver Information Centre.

The traction control system is not operational. Have the cause of the fault remedied by a workshop.

Vehicle messages ⇨ 105.

Driver Information Centre ⇨ 104.

Electronic Stability Control

The Electronic Stability Control (ESC) improves driving stability when necessary, regardless of the type of road surface or tyre grip. It also prevents the drive wheels from spinning.

As soon as the vehicle starts to swerve (understeer / oversteer), engine output is reduced and the wheels are braked individually. This considerably improves the driving stability of the vehicle on slippery road surfaces.

ESC is operational as soon as the ignition is switched on and control indicator  extinguishes in the instrument cluster.

When ESC comes into action  flashes.

Warning

Do not let this special safety feature tempt you into taking risks when driving.

Adapt speed to the road conditions.

Control indicator  ⇨ 100.

Trailer stability assist ⇨ 265.

Enhanced traction function



If necessary, in the event of soft ground, mud or snow-covered road surfaces, ESC can be deactivated to enhance traction:

Press .

A message appears in the Driver Information Centre.

When vehicle speed reaches 30 mph, the system switches automatically to standard ESC operation. A message appears in the Driver Information Centre.

ESC is reactivated by pressing  again.

ESC is also reactivated the next time the ignition is switched on.



Engine drag torque control

The engine drag torque control system is an integral feature of ESC. When downshifting under slippery road conditions, the engine speed and torque increases to help prevent locking of the drive wheels during sudden deceleration.

Side wind assist

The side wind assist is an integral feature of ESC and maintains the vehicle's path. When the system comes into action  appears in the Driver Information Centre.

Fault

If the system detects a fault, control indicator  100 illuminates together with  98 in the instrument cluster and a corresponding message appears in the Driver Information Centre .

The ESC is not operational. Have the cause of the fault remedied by a workshop.

Vehicle messages .

Driver Information Centre .

Limited-slip rear axle

Rear-wheel drive vehicles may be equipped with an automatic locking rear differential which automatically controls the torque transmitted to each rear wheel, enhancing traction in the event of soft ground, mud or snow-covered road surfaces.

 Warning

Do not let this special safety feature tempt you into taking risks when driving.

Adapt speed to the road conditions.

When vehicle speed reaches 20 mph, or once the rear wheels return to surfaces with normal grip, e.g. paved roads, the system automatically deactivates, sometimes accompanied by a noise (with no consequence to vehicle behaviour).

The system can also be deactivated manually once normal grip conditions have resumed by briefly releasing the accelerator.

Driver assistance systems** Warning**

Driver assistance systems are developed to support the driver and not to replace the driver's attention.

The driver accepts full responsibility when driving the vehicle.

When using driver assistance systems, always take care regarding the current traffic situation.

Cruise control

The cruise control can store and maintain speeds of 20 mph and above. Deviations from the stored speeds may occur when driving uphill or downhill. The stored speed will flash in the Driver Information Centre .

For safety reasons the cruise control cannot be activated until the brake pedal has been operated once.



Do not use the cruise control if it is not advisable to maintain a constant speed.

With manual transmission automated, only activate cruise control in automatic mode.

Control indicators  and  → 102.



Switching on the system





Press , control indicator  illuminates green in the instrument cluster.

Cruise control is now in standby mode and a corresponding message appears in the Driver Information Centre.



Accelerate to the desired speed and press  or . The current speed is now stored and maintained and the accelerator pedal can be released.



Control indicator  illuminates green in the instrument cluster together with  and a corresponding message appears in the Driver Information Centre.

Vehicle speed can be increased by depressing the accelerator pedal. The stored speed flashes in the instrument cluster. When the accelerator pedal is released, the previously stored speed is resumed.

Cruise control remains activated while gearshifting.

The speed is saved until the ignition is switched off.

Increase speed

With cruise control active, the vehicle speed can be increased continuously or in small increments by holding down or tapping **+** repeatedly.

When the switch is released the current speed is stored and maintained.

Alternatively, accelerate to the desired speed and store by pressing **+**.

Reduce speed

With cruise control active, the vehicle speed can be decreased continuously or in small increments by holding down or tapping **-** repeatedly.

When the switch is released the current speed is stored and maintained.

Deactivation of the functionality

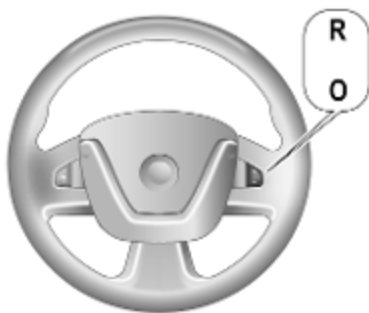

Press **O**: cruise control is deactivated and the green control indicator  extinguishes in the instrument cluster.

Automatic deactivation:

- vehicle speed drops below 20 mph
- the brake pedal is depressed
- the clutch pedal is depressed
- selector lever in **N**



The speed is stored and a corresponding message appears in the Driver Information Centre.

Activation of the functionality

Press **R** at a speed above 20 mph. If the stored speed is much higher than the current speed, the vehicle will accelerate powerfully until the stored speed is obtained.

Pressing **+** will also reactivate the cruise control function, but at the current vehicle speed only, not the stored speed.

Switching off the system



Press , green control indicators  and  extinguish in the instrument cluster.

Speed limiter

The speed limiter prevents the vehicle exceeding a preset maximum speed above 20 mph.

Switching on the system



Press , control indicator  illuminates yellow in the instrument cluster.

Speed limiter function is now in standby mode and a corresponding message appears in the Driver Information Centre.



Accelerate to the desired speed and press **+** or **-**. The current speed is recorded.

The vehicle can be driven normally but it will not be possible to exceed the programmed speed limit except in an emergency.

Where the limit speed cannot be maintained, e.g. when driving on a steep decline, the limit speed will flash in the Driver Information Centre.

Increase limit speed

The limit speed can be increased continuously or in small increments by holding down or tapping **+** repeatedly.

Reduce limit speed

The limit speed can be decreased continuously or in small increments by holding down or tapping **-** repeatedly.

Exceeding the limit speed

In the event of an emergency it is possible to exceed the limit speed by depressing the accelerator pedal firmly beyond the point of resistance.

The limit speed will flash in the Driver Information Centre during this period.

Release the accelerator pedal and the speed limiter function is reactivated once a speed lower than the limit speed is obtained.

Speed warning  103.

Deactivation of the functionality

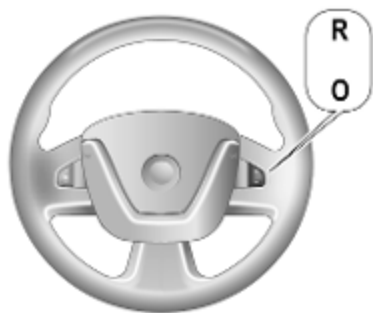

Press **O**: speed limiter is deactivated and the vehicle can be driven normally.

The limit speed is stored and a corresponding message appears in the Driver Information Centre.

Activation of the functionality

Press **R**. The speed limiter function is reactivated.

Pressing **+** will also reactivate the speed limiter function, but at the current vehicle speed only, not the stored speed.

Switching off the system

Press .

Yellow control indicator  extinguishes in the instrument cluster.

Active emergency braking

Active emergency braking can help to reduce the damage and injury from crashes with vehicles directly ahead, when a collision can no longer be avoided either by manual braking or by steering. The feature uses various inputs (e.g. camera sensor, radar sensor, brake pressure, vehicle speed) to calculate the probability of a frontal collision.

Warning

This system is not intended to replace the driver responsibility for driving the vehicle and looking ahead. Its function is limited to supplemental use only to reduce the vehicle speed before a collision.

The system only detects vehicles driving in the same direction of traffic.

After a sudden lane change, the system needs a certain time to detect the next preceding vehicle.

The driver must always be ready to take action and apply the brakes and steer to avoid collisions.

Operation conditions

The system is operational at a vehicle speed between 10 mph and 62 mph.

Activation

The system is automatically active when the ignition is switched on.

Functionality

When driving in the speed range mentioned above and a risk of collision with the vehicle ahead is imminent,  will flash and a warning chime sounds.

The indicator light  and the chimes stop when the system detects that a collision is not imminent anymore.

Just before the imminent collision, the system brakes automatically to reduce the impact speed of the collision or prohibit a crash.

Warning

Do not rely on the system to brake the vehicle. Active emergency braking will not brake outside of its operating speed range and only responds to detected vehicles.

Deactivation and re-activation

Active emergency braking can be deactivated with the vehicle stationary and the ignition switched on:



Toggle through the Driver Information Centre with the buttons on the right lever until message **Active braking** appears.

To deactivate the system, press and hold one of the two buttons for approx. 3 seconds.  illuminates in the instrument cluster until system is re-activated again.

To re-activate the system, press and hold one of the two buttons for approx. 3 seconds.  disappears.

We recommend to deactivate the system in the vehicle personalisation in the following cases:

- when the vehicle is being towed
- before using an automatic car wash with ignition switched on
- if the windscreen has been damaged close to the camera
- if the front bumper has been damaged

Conditions for re-activation

The Active emergency brake system can only be re-activated if:

- the gear lever is not in neutral
- parking brake is not activated
- vehicle is not cornering

System limitations

In some cases, the active emergency braking system may provide an automatic braking in situations that seem to be unnecessary, for instance in parking garages, due to traffic signs in a curve or due to vehicles in another lane. This is normal operation, the vehicle does not need service. Firmly apply the accelerator

pedal to override the automatic braking if the situation and the surroundings permit.



In the following cases, active emergency braking performance is limited:



- driving on winding or hilly roads
- detecting all vehicles, especially vehicles with a trailer, tractors, muddy vehicles, etc.
- detecting a vehicle when weather limits visibility, such as in fog, rain, or snow
- driving during nighttime
- sensor in the windscreen or radar unit behind the front bumper blocked by snow, ice, slush, mud, dirt, etc.
- windscreen damaged or affected by foreign objects, e.g. stickers

Complete attention is always required while driving, and you should be ready to take action and apply the brakes and / or steer the vehicle to avoid crashes.

Fault

In case the system requires a service, a message is displayed in the Driver Information Centre.

Additionally, warning lights  and  illuminate at the same time.

When the system detects that its function is not available, warning light  or  illuminates and stays on. Additionally, a message in the Driver Information Centre appears. The system may be temporarily disrupted (for example: radar or camera obscured by dirt, mud, snow etc.). In this case, park the vehicle and switch off the engine. Clean the windscreen area around the camera and the detection zone of the radar in the front bumper. When the warning lights and messages still appear after starting the vehicle again, seek the assistance of a workshop.

Parking assist

Warning

It is the driver who bears full responsibility for the parking manoeuvre.

Always check the surrounding area while reversing and using the rear parking assist system.

The parking assist measures the distance between the vehicle and obstacles behind and, if available, in front of the vehicle. It informs and warns the driver by giving acoustic signals.

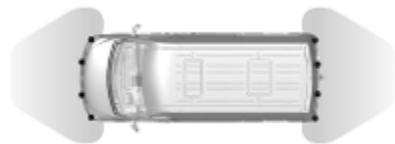

The system consists of four ultrasonic parking sensors in the rear bumper and, if available, four ultrasonic parking sensors in the front bumper.

The ultrasonic parking sensors can be activated or deactivated in the settings menu in the Info Display.

Notice

Attached parts in the detection area cause system malfunction.

Activation

The rear parking assist is activated when reverse gear is engaged. The front-rear parking assist is activated when a gear is engaged. Readiness for operation is indicated by a brief acoustic signal.

Indication

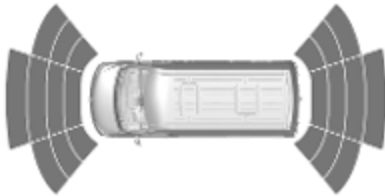

The interval between the acoustic signals becomes shorter as the vehicle gets closer to the obstacle. When the distance is less than 30 cm, the signal is continuous. Additionally, the distance to obstacles is displayed by changing distance lines in the Info Display.

Deactivation



The system can be deactivated by pressing **P** . The LED in the button illuminates when deactivated. Depending on version, the system can also be deactivated in the settings menu in the Info Display.

Manual deactivation

The system must be deactivated before towing or if the sensors are damaged.

Automatic deactivation

The system will automatically be deactivated when:

- the vehicle speed is above 6 mph
- selector lever in **N**
- depending on version, when the vehicle is stationary for more than approx. 5 seconds and an obstacle is detected

Fault

If the system detects an operating fault, a continuous acoustic alarm will sound for approx. 3 seconds. Consult a workshop to have the cause of the fault remedied.

Caution

When reversing, the area should be free from obstacles which could impact on the underside of the vehicle.

Impact to the rear axle, which may not be visible, could lead to uncharacteristic changes in the vehicle handling. In the event of such an impact, consult a workshop.

Basic notes on parking assist system**⚠ Warning**

Under certain circumstances, various reflective surfaces on objects or clothing as well as external noise sources may cause the system to fail to detect obstacles.

Special attention must be paid to low obstacles which can damage the lower part of the bumper.

Caution

Performance of the sensors can be reduced when sensors are covered, e.g. by ice or snow.

Performance of the parking assist system can be reduced due to heavy loading.

Special conditions apply if there are taller vehicles involved (e.g. off-road vehicles, mini vans, vans). Object identification in the upper part of these vehicles cannot be guaranteed.

Objects with a very small reflection cross-section, e.g. objects of narrow size or soft materials, may not be detected by the system.

The parking assist system will not detect objects which are out of the detection range of the sensors.

Side blind spot alert

The side blind spot alert system detects and reports objects on either side of the vehicle, within a specified blind spot zone. The system displays a visual alert in each exterior mirror,

when detecting objects that may not be visible in the interior and exterior mirrors.

Side blind spot alert uses some of the parking assist sensors which are located in the front and rear bumper on both sides of the vehicle.

⚠ Warning

Side blind spot alert does not replace driver vision.

The system does not detect:

- vehicles outside the side blind zones which may be rapidly approaching
- pedestrians, cyclists or animals

Before changing a lane, always check all mirrors, look over the shoulder and use the turn signal.

Activation

The system is activated when the speed of the vehicle is between approx. 19 mph and 87 mph.

Deactivation



To deactivate the system, press  with the ignition on. The LED in the button illuminates when deactivated.

To reactivate the system, press  again. The LED in the button extinguishes.

Functionality



When the system detects a vehicle in the side blind zone while driving forwards, an LED will illuminate in the relevant exterior mirror.

The LED comes on immediately when being passed.

The LED comes on after a delay when passing another vehicle slowly.

The LED flashes when the turn lights are activated and a vehicle is detected.

Operation conditions

The following conditions must be fulfilled for proper operation:

- all vehicles are moving in the same direction and in adjacent lanes
- the speed of your vehicle is between 19 mph and 87 mph
- the traffic flow is normal
- driving on a straight or slightly curved road
- the vehicle is not pulling a trailer
- the sensors are not covered by mud, ice or snow
- the warning zones in the exterior mirrors or the detection zones in front and rear bumper are not covered

No alert will be given in the following situations:

- in the presence of non-moving objects, e.g. parked vehicles, barriers, street lamps, road signs
- with vehicles moving in the opposite direction

- driving on a winding road or a sharp corner
- when passing or being passed by a very long vehicle, e.g. lorry, coach, which is at the same time detected at the rear in the blind spot angle and present in the driver's forward field of vision
- in very heavy traffic, vehicles detected in front and behind are confused with a lorry or a stationary object
- when passing too quickly

Fault

In the event of a fault, a corresponding message will be displayed in the instrument cluster. Have the cause of the fault remedied by a workshop.

Rear view camera

The rear view camera assists the driver when reversing by displaying a view of the area behind the vehicle in either the interior mirror or the Info Display.

⚠ Warning

The rear view camera does not replace driver vision. Note that objects that are outside the camera's field of view, e.g. below the bumper or underneath the vehicle, are not displayed.

Do not reverse the vehicle by only looking at the display and check the surrounding area behind and around the vehicle before reversing.



The camera is typically installed on the rear doors, beneath the number plate moulding.

The area displayed by the camera is limited. The distance of the image that appears on the display differs from the actual distance.

Rear view display ⇨ 40.

Notice

To achieve the optimum visibility, the rear view camera must not be obscured by dirt, snow or ice.

Activation

Interior mirror display



The interior mirror display is automatically activated when reverse gear is engaged. An audible signal confirms activation.

Info Display



In vehicles without interior mirror display, the rear view camera screen is shown on the Info Display.

Trajectory lane display image (1)

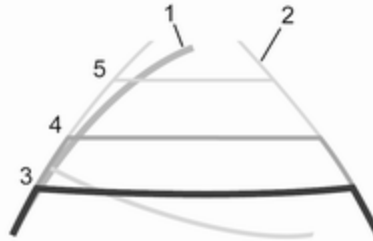

Depending on version, the trajectory lane (1) of the vehicle is shown in blue on the Info Display. It shows the path of the vehicle in accordance with the steering angle.

Fixed lane display image (2)

The fixed lane display (2) shows the path of the vehicle if the wheels are kept straight.

Guide lines (3, 4, 5) are used together with the fixed lane display (2) and indicate the distance behind the vehicle.

The guide line intervals are as follows:

- 3 (red) : 30 cm
- 4 (yellow) : 70 cm
- 5 (green) : 150 cm

Settings

Settings, e.g. brightness, can be set via the Infotainment system. Refer to Infotainment manual for further information.

Deactivation

The camera is deactivated after a delay if reverse gear is not engaged.

Fault

The rear view camera may not operate properly when:

- the surrounding is dark
- the sun or the beam of headlights is shining directly into the camera lens
- ice, snow, mud, or anything else covers the camera lens. Clean the lens, rinse it with water, and wipe it with a soft cloth

- the rear doors are not closed correctly
- the vehicle had a rear-end accident
- there are extreme temperature changes

Lane departure warning

The lane departure warning system uses a front camera to observe the lane markings between which the vehicle is driving. The system detects lane changes and warns the driver in the event of an unintended lane change via visual and acoustic signals.

Criteria for the detection of an unintended lane change are:

- no operation of turn lights
- no active steering



If the driver is performing these actions, no warning will be issued.

Activation



The lane departure warning system is activated by pressing  in the centre console. A corresponding message appears in the Driver Information Centre to indicate that the system is switched on.



When   100 illuminates in the Driver Information Centre, the system is ready to operate  104.

 extinguishes when the system is not ready to warn the driver.

The system is only operable at vehicle speeds above approx. 37 mph and if lane markings are available and detected.

If the turn lights are not operated when changing lanes, i.e. an unintended lane change is detected, control indicator  flashes together with a warning chime to alert the driver.

Deactivation

The system is deactivated by pressing . A corresponding message appears in the Driver Information Centre to indicate that the system is switched off.

At speeds below approx. 37 mph the system is inoperable.

Operation hints

The lane departure warning system may not operate properly when:

- The windscreen is not clean.
- There are adverse environmental conditions like heavy rain, snow, direct sunlight or shadows.
- Lane departure is very fast.
- Acceleration is very strong.
- Bends are tight.
- Driving continuously on a line.

The system cannot operate when no lane marking is detected.

Fault

In the event of a fault in the system, a warning message appears in the Driver Information Centre (possibly in combination with control indicator ).

Seek the assistance of a workshop.

Driver Information Centre  104.

Fuel

Fuel for diesel engines

The Diesel engines are compatible with bio-fuels that conform to current and future European standards and can be obtained from filling stations:



Diesel fuel that meets standard EN590 mixed with a biofuel that meets standard EN14214 (possibly containing up to 7% Fatty Acid Methyl Ester).

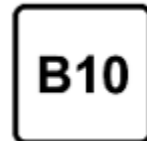

Diesel fuel that meets standard EN16734 mixed with a biofuel that meets standard EN14214 (possibly containing up to 10% Fatty Acid Methyl Ester).



Paraffinic Diesel fuel that meets standard EN15940 mixed with a biofuel that meets standard EN14214 (possibly containing up to 7% Fatty Acid Methyl Ester).

If travelling in countries outside the European Union, occasional use of Euro-Diesel fuel with a sulphur concentration below 50 ppm is possible.

Caution

Frequent usage of diesel fuel containing more than 15 ppm sulphur will cause severe engine damage.

Caution

Use of fuel that does not comply to EN 590 or similar can lead to engine powerloss, increased wear or engine damage and may affect your warranty.

Do not use marine diesel oils, heating oils, Aquazole and similar diesel-water emulsions. Diesel fuels must not be diluted with fuels for petrol engines. Do not use additives.

The flow and filterability of diesel fuels are temperature-dependent. When temperatures are low, refuel with diesel fuel with guaranteed winter properties.

Diesel fuel system bleeding ⇨ 275.

Low temperature operation

At temperatures below 0 °C, some diesel products with biodiesel blends may clog, freeze or gel, which may affect the fuel supply system. Starting and engine operation may not work

properly. Make sure to fill winter grade diesel fuel at ambient temperatures below 0 °C.

Arctic grade diesel fuel can be used in extreme cold temperatures below -20 °C. Using this fuel grade in warm or hot climates is not recommended and may cause engine stalling, poor starting or damage to the fuel injection system.

Refuelling

⚠ Danger

Before refuelling, switch off engine and any external heaters with combustion chambers. Switch off any mobile phones.

Follow the operating and safety instructions of the filling station when refuelling.

⚠ Danger

Fuel is flammable and explosive. No smoking. No naked flames or sparks.

If you can smell fuel in your vehicle, have the cause of this remedied immediately by a workshop.

A label with symbols at the fuel filler flap is indicating the allowed fuel types. In Europe the pump nozzles of the filling stations are marked with these symbols. Refuel only the allowed fuel type.

Caution

In case of misfuelling, do not switch on ignition.

The fuel tank filler neck with bayonet cap is located on the left front side of the vehicle.

The fuel filler flap can only be opened if the vehicle is unlocked and the door is opened. Open the fuel filler flap by hand.

⚠ Danger

Vehicles with stop-start system: The engine must be switched off and the ignition key removed, to avoid risk of engine being restarted automatically by the system.

Capacities ⇨ 315.



Depending on vehicle, unlock fuel filler cap using the key.

To open, turn the cap slowly anticlockwise.

The fuel filler cap can be hung on the lower hook of the fuel filler flap.

Place the nozzle in straight position to the filler neck and press with slight force to insert.

After the automatic cut-off, the tank can be topped up by operating the pump nozzle a maximum of two more times.

Caution

Wipe off any overflowing fuel immediately.

To close, turn the fuel filler cap clockwise.

Close the fuel filler flap.

Fuel filler cap

Only use genuine fuel filler caps. Diesel-engined vehicles have special fuel filler caps.

Trailer hitch

General information

Only use towing equipment that has been approved for your vehicle. Entrust fitting of towing equipment at a later date to a workshop. It may be necessary to make changes that affect the cooling system, heat shields or other equipment.

Driving characteristics and towing tips

In the case of trailers with brakes, attach the breakaway stopping cable. Before attaching a trailer, lubricate the coupling ball. However, do not do so if a stabiliser, which acts on the coupling ball, is being used to reduce snaking movements. For trailers with low driving stability the use of a stabiliser is recommended.

A maximum speed of 50 mph must not be exceeded, even in countries where higher speeds are permitted.

If the trailer starts snaking, drive more slowly, do not attempt to correct the steering and brake sharply if necessary.

When driving downhill, drive in the same gear as if driving uphill and drive at a similar speed.

Adjust tyre pressure to the value specified for full load ⇨ 315.

Trailer towing

Trailer loads

The permissible trailer loads are vehicle-dependent and engine-dependent maximum values which must not be exceeded. The actual trailer load is the difference between the actual gross weight of the trailer and the actual coupling socket load with the trailer coupled.

The permissible trailer loads are specified in the vehicle documents. In general, they are valid for gradients up to max. 12%.

The permitted trailer load applies up to the specified incline and up to an altitude of 1000 m above sea level.

Since engine power decreases as altitude increases due to the air becoming thinner, therefore reducing climbing ability, the permissible gross train weight also decreases by 10% for every 1000 m of additional altitude. The gross train weight does not have to be reduced when driving on roads with slight inclines (less than 8%, e.g. motorways).

The permissible gross train weight must not be exceeded. This weight is specified on the identification plate ⇨ 314.

Vertical coupling load

The vertical coupling load is the load exerted by the trailer on the coupling ball. It can be varied by changing the weight distribution when loading the trailer.

The maximum permissible vertical coupling load is specified on the towing equipment identification plate and in the vehicle documents. Always aim for the maximum load, especially in the case of heavy trailers. The vertical coupling load should never fall below 25 kg.

In the case of trailer loads of 1200 kg or more, the vertical coupling load should not be less than 50 kg.

Rear axle load

When the trailer is coupled and the towing vehicle fully loaded (including all occupants), the permissible rear axle load (see identification plate or vehicle documents) can be exceeded by 15%. If the permissible rear axle load is exceeded, a maximum speed of 48 mph applies and the tyre pressure must be increased by 20 kPA / 3 psi.

Towing equipment

For vehicles fitted with towing equipment, when connected to a trailer the pitch of the audible warning changes upon operation of the turn lights.

The pitch of the audible warning will change if a turn light on the trailer or the towing vehicle fails.

Trailer stability assist

If the system detects snaking movements, engine power is reduced and the vehicle / trailer combination is selectively braked until the snaking ceases. While the system is working, keep steering wheel as still as possible.

Trailer stability assist is a function of the Electronic Stability Control (ESC) ⇨ 247.

Auxiliary features

Power take-off



Activation

To activate the power take-off, with the vehicle stationary and the engine idling:

- Set the gearshift lever to neutral (vehicles with manual transmission automated: selector lever in position **N**).
- Depress the clutch pedal.

- Press switch on the instrument panel; LED in switch illuminates after approx. 2 seconds.
- Release the clutch pedal.

The engine idle speed increases to 1,200 rpm.

Caution

During operation of the power take-off, never move the selector lever out of neutral (vehicles with manual transmission automated: selector lever in position **N**), to avoid damage to the transmission. If a gear change becomes necessary, i.e. to adjust the driving speed, the power take-off must always be deactivated first.

Deactivation

To deactivate the power take-off:

- Depress the clutch pedal.
- Press switch on the instrument panel; LED in switch extinguishes after approx. 2 seconds.
- Release the clutch pedal.

Fault

If the LED in the switch does not illuminate when attempting to activate the power take-off and / or the system does not operate:



Gradually release the clutch pedal.

- or -

- Set the gearshift lever to neutral (vehicles with manual transmission automated: selector lever in position **N**).
- Depress the clutch pedal.
- Press switch on the instrument panel. The LED in switch illuminates after approx. 2 seconds.
- Release the clutch pedal.

Then repeat the above procedure.

Notice

The power take-off function is not available when control indicator  \diamond 98, STOP \diamond 99 or  \diamond 100 is illuminated.

Vehicle care

General Information 268

- Accessories and vehicle modifications 268
- Vehicle storage 268
- End-of-life vehicle recovery 269

Vehicle checks 269

- Performing work 269
- Bonnet 269
- Engine oil 270
- Engine coolant 272
- Power steering fluid 272
- Washer fluid 272
- Brakes 273
- Brake fluid 273
- Vehicle battery 273
- Diesel fuel system bleeding 275
- Wiper blade replacement 276

Bulb replacement 276

- Headlights 277
- Front fog lights 278
- Front turn lights 278
- Tail lights 279
- Side turn lights 281
- Centre high-mounted brake light 281

- Number plate light 282
- Interior lights 283
- Instrument panel illumination ... 284

Electrical system 284

- Fuses 284
- Engine compartment fuse box . 285
- Instrument panel fuse box 286
- Load compartment fuse box 287

Vehicle tools 289

- Tools 289

Wheels and tyres 290

- Tyres 290
- Winter tyres 290
- Tyre designations 290
- Tyre pressure 290
- Tyre pressure monitoring system 291
- Tread depth 293
- Changing tyre and wheel size . 294
- Wheel covers 294
- Tyre chains 294
- Tyre repair kit 295
- Wheel changing 298
- Spare wheel 300

Jump starting 303

Towing 305

- Towing the vehicle 305
- Towing another vehicle 306

Appearance care 307

- Exterior care 307
- Interior care 309

General Information

Accessories and vehicle modifications

We recommend the use of genuine parts and accessories and factory approved parts specific for your vehicle type. We cannot assess or guarantee reliability of other products - even if they have a regulatory or otherwise granted approval.

Any modification, conversion or other changes made to standard vehicle specifications (including, without limitation, software modifications, modifications of the electronic control units) may invalidate the warranty offered by Vauxhall. Furthermore, such changes may affect driver assistance systems, fuel consumption, CO₂ emissions and other emissions of the vehicle. They may also invalidate the vehicle operating permit.

Caution

When transporting the vehicle on a train or on a recovery vehicle, the mud flaps might be damaged.

Vehicle storage

Storage for a long period of time

If the vehicle is to be stored for several months:

- Wash and wax the vehicle.
- Have the wax in the engine compartment and underbody checked.
- Clean and preserve rubber seals.
- Change engine oil.
- Drain washer fluid reservoir.
- Check coolant antifreeze and corrosion protection.
- Adjust tyre pressure to the value specified for full load.
- Park vehicle in a dry, well ventilated place. Engage first or reverse gear. Prevent the vehicle from rolling.

- Do not apply parking brake.
- Close all doors except front left-hand door and lock the vehicle.
- Disconnect the clamp from the negative terminal of the vehicle battery. Note that all systems are not functional, e.g. anti-theft alarm system.
- Close and lock front left-hand door.

Putting back into operation

When the vehicle is to be put back into operation:

- Connect the clamp to the negative terminal of the vehicle battery. Initialize the power windows ⇨ 41.
- Check tyre pressure.
- Fill up the washer fluid reservoir.
- Check the engine oil level.
- Check the coolant level.
- Fit the number plate, if necessary.

End-of-life vehicle recovery

Information on end-of-life vehicle recovery centres and the recycling of end-of-life vehicles is available on our website, where legally required. Only entrust this work to an authorised recycling centre.

Vehicle checks

Performing work

⚠ Warning

Only perform engine compartment checks when the ignition is off. The vehicle must not be in an Autostop ⇨ 227.

The cooling fan may start operating even if the ignition is off.

⚠ Danger

The ignition system generates extremely high voltages. Do not touch.

The caps for topping up the engine oil, the coolant, the washer fluid and the oil dipstick handle are yellow for ease of identification.

Bonnet

Opening



Pull the release lever and return it to its original position.

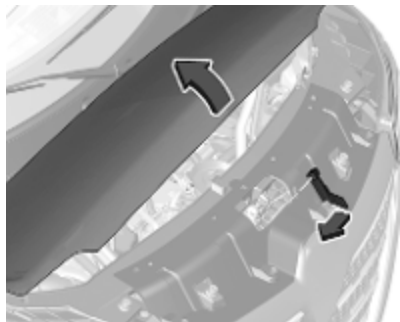

Push the safety catch to the side and open the bonnet.

Depending on version, pull the safety catch, located slightly beside the centre, and open the bonnet.

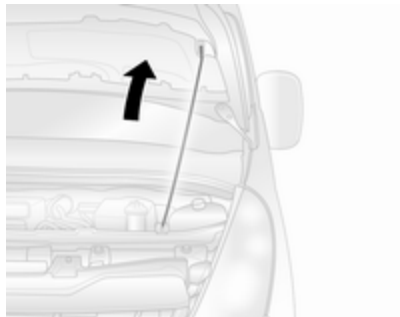

Pull up the support rod from its holder, then secure it in the hook on the underside of the bonnet.

If the bonnet is opened during an Autostop, the engine will be restarted automatically for safety reasons.

Stop-start system ⇨ 227.

Caution

Ensure the windscreen wiper is switched off before opening the bonnet ⇨ 85.

Closing

Before closing the bonnet, press the support into the holder.

Lower the bonnet and allow it to drop into the catch from a low height (20-25 cm). Check that the bonnet is engaged.

Caution

Do not press the bonnet into the latch, to avoid dents.

⚠ Warning

In the event of even a minor head-on collision, have the bonnet safety catch checked by a workshop.

Engine oil

Check the engine oil level manually on a regular basis to prevent damage to the engine.

Ensure that the correct specification of engine oil is used.

Recommended fluids and lubricants ⇨ 311.

The maximum engine oil consumption is 0.6 l per 600 miles.

Check with the vehicle on a level surface. The engine must be at operating temperature and switched off for at least 10 minutes.

Caution

It is the owner's responsibility to maintain the proper level of an appropriate quality oil in the engine.

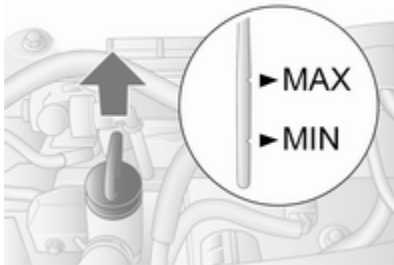

Pull out the dipstick, wipe it clean, reinsert fully, pull out and read the engine oil level.

When the engine oil level has dropped to the **MIN** mark, top-up engine oil.

Caution

Do not allow the engine oil level to drop below the minimum level!

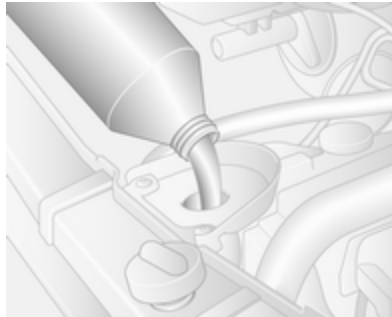

We recommend the use of the same type of engine oil that was used at the last change.

Between the **MIN** and **MAX** marks a volume of approx. 1.5 - 2.0 l can be filled in.

The engine oil level must not exceed the maximum mark **MAX** on the dipstick.

Caution

Overfilled engine oil must be drained or suctioned out. If the oil exceeds the maximum level, do not start the vehicle and contact a workshop.

To prevent spillage when replenishing the engine oil, we recommend using a funnel. Ensure funnel is securely located onto the filler pipe.

A stabilisation of the engine oil consumption will not take place until the vehicle has been driven several thousand miles. Only then can the actual degree of consumption be established.

If consumption exceeds more than 0.6 l every 600 miles after this running-in period, consult a workshop.

Fit the cap on straight and tighten it.

Engine coolant

The factory filled coolant provides freeze protection down to approx. -28 °C.

Caution

Only use approved antifreeze.

Coolant level

Caution

Too low a coolant level can cause engine damage.

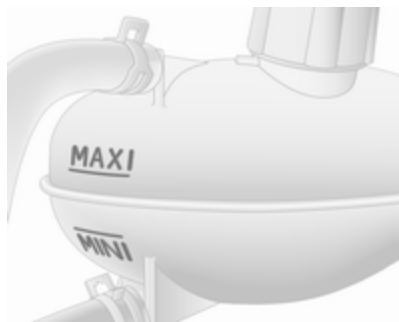

If the cooling system is cold, the coolant level should be just above the **MINI** mark. Top up if the level is low.

⚠ Warning

Allow the engine to cool before opening the cap. Carefully open the cap, relieving the pressure slowly.

Top up with antifreeze. If no antifreeze is available, use clean tap water or distilled water. Install the cap tightly. Have the antifreeze concentration checked and have the cause of the coolant loss remedied by a workshop.

If a substantial amount of coolant is required, it will be necessary to bleed any trapped air from the cooling system. Seek the assistance of a workshop.

Power steering fluid

If an unusual noise is heard during steering or if the power steering reacts conspicuously, seek the assistance of a workshop.

The power steering fluid reservoir is located below the front left wheel arch, behind a trim panel. Access is only possible for a workshop.

Washer fluid



Fill with clean water mixed with a suitable quantity of windscreen washer fluid which contains antifreeze.

Caution

Only washer fluid with a sufficient antifreeze concentration provides protection at low temperatures or a sudden drop in temperature.

Use of washer fluid containing isopropanol can damage exterior lamps.

Brakes

In the event of minimum thickness of the brake lining, a squealing noise sounds during braking.

Continued driving is possible but have the brake linings replaced as soon as possible.

Once new brake linings are installed, do not brake unnecessarily hard for the first few journeys.

Brake fluid**⚠ Warning**

Brake fluid is poisonous and corrosive. Avoid contact with eyes, skin, fabrics and painted surfaces.

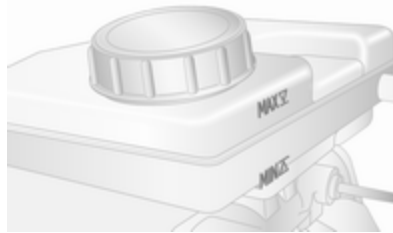

The brake fluid level must be between the **MIN** and **MAX** marks.

When topping up, ensure maximum cleanliness as contamination of the brake fluid can lead to brake system malfunctions. Have the cause of the loss of brake fluid remedied by a workshop.

Only use brake fluid approved for your vehicle.

Brake and clutch fluid ⇨ 311.

Vehicle battery

The jump start terminal is located in the engine compartment.

Jump starting ⇨ 303.

The vehicle battery is maintenance-free provided that the driving profile allows sufficient charging of the battery. Short-distance-driving and frequent engine starts can discharge the battery. Avoid the use of unnecessary electrical consumers.

Control indicator  illuminates if there is a fault with the charging system. Stop, switch off engine and seek the assistance of a workshop.

Charging system ⇨ 98.



Batteries do not belong in household waste. They must be disposed of at an appropriate recycling collection point.

Laying up the vehicle for more than four weeks can lead to battery discharge. Disconnect the clamp from the negative terminal of the vehicle battery.

⚠ Danger

Ensure the ignition is switched off completely (the vehicle must not be in an Autostop) before connecting or disconnecting the vehicle battery.

Stop-start system ⇨ 227.

The anti-theft alarm siren must be deactivated as follows: Switch the ignition on then off, disconnect the vehicle's battery within 15 seconds. Battery discharge protection ⇨ 116.

Battery access



The battery is located behind a panel in the front left-hand door step. Remove the panel to access the battery.

Replacing the vehicle battery

Ensure that the battery is always replaced by the same type of battery. Seek the assistance of a workshop to have the vehicle battery replaced.

Stop-start system ⇨ 227.

Charging the vehicle battery

⚠ Warning

On vehicles with stop-start system, ensure that the charging potential does not exceed 14.6 V when using a battery charger. Otherwise the vehicle battery may be damaged.

⚠ Danger

Ensure adequate ventilation when charging the battery. There is a risk of explosion if gases generated during charging are allowed to accumulate!

Jump starting ⇨ 303.

Warning label



Meaning of symbols:

- No sparks, naked flames or smoking.
- Always shield eyes. Explosive gases can cause blindness or injury.
- Keep the vehicle battery out of reach of children.
- The vehicle battery contains sulfuric acid which could cause blindness or serious burn injuries.

- See the Owner's Manual for further information.
- Explosive gas may be present in the vicinity of the battery.

Additional battery

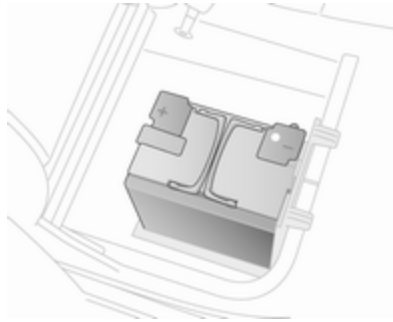

Depending on the vehicle's auxiliary equipment, certain models may have an additional battery mounted under the right-hand front seat.

Notice

The additional battery is automatically connected to the main vehicle battery only when the engine is running. It does not need to be manually disconnected before

disconnecting the main vehicle battery or before jump starting the vehicle.

The terminals are designed for additional electrical consumers up to a maximum of 50 A.

Jump starting ⇨ 303.

Diesel fuel system bleeding

If the fuel tank has been run dry, it will be necessary to air vent or bleed the diesel fuel system.

Fill the tank with fuel and proceed as follows:

Caution

Do not turn ignition key to position **3** before beginning the bleeding procedure.

Ignition switch positions ⇨ 225.

1. Turn ignition key to position **2** and wait for a few minutes.
2. Turn key back to position **1** and wait for 3 seconds.
3. Turn key to position **3**.

If the engine cannot be started after several attempts to bleed the diesel fuel system, seek the assistance of a workshop.

Wiper blade replacement

Wiper blades on the windscreen

If required, use the step located below the headlights to reach the windscreen wiper.

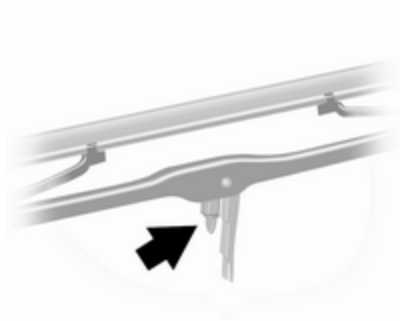

Lift wiper arm, press retaining clip towards wiper arm and detach wiper blade.

Attach the wiper blade slightly angled to the wiper arm and push until it engages.

Lower wiper arm carefully.

Bulb replacement

Ensure the ignition is switched off completely (the vehicle must not be in an Autostop ⇨ 227) and turn off the relevant switch or close the doors.

Only hold a new bulb at the base. Do not touch the bulb glass with bare hands.

Use only the same bulb type for replacement.

Have additional lighting bulbs of the body conversions replaced by a workshop.

Bulb check

After a bulb replacement, switch on the ignition, operate and check the lights.

Performing work ⇨ 269.

Headlights

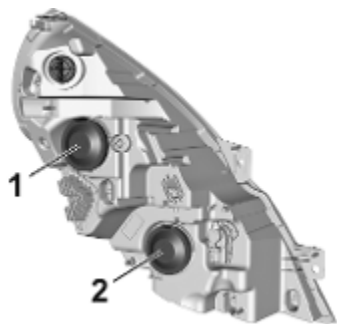

Headlights have separate systems for high beam 1 and low beam 2.

High beam



1. Remove the protective cover by pulling the tab.



2. Press retaining clip downwards and pull the bulb socket toward the rear.

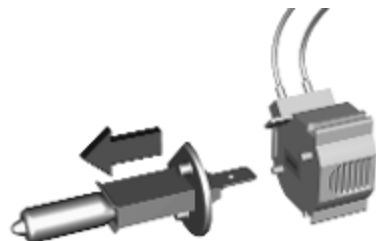

3. Detach the bulb from the bulb socket and replace the bulb.
4. Insert the bulb socket into the reflector housing.
5. Fit the cap on.

Low beam



1. Remove the protective cover by pulling the tab.

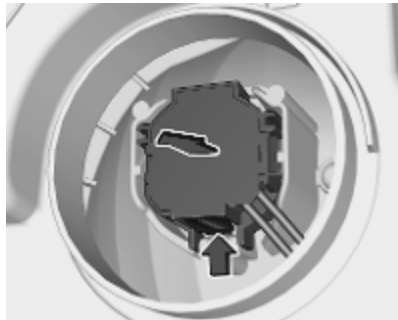

2. Press retaining clip upwards and pull the bulb socket toward the rear.

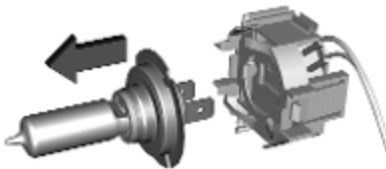

3. Detach the bulb from the bulb socket and replace the bulb.
4. Insert the bulb socket into the reflector housing.
5. Fit the cap on.

Sidelights

Have lights repaired by a workshop in case of failure.

Front fog lights

Have the front fog light bulbs replaced by a workshop.

Front turn lights



1. Rotate bulb holder anticlockwise to disengage.
2. Withdraw bulb holder from reflector housing.

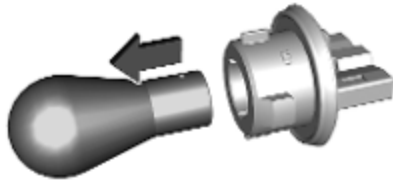

3. Detach bulb from bulb holder and renew the bulb.
4. Insert the bulb holder and rotate clockwise to secure.

Tail lights

Turn light, tail and brake light, reversing light, rear fog light

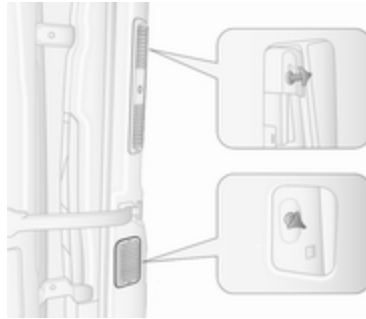

1. Remove the upper and lower trim panels from the rear pillar.
2. Unscrew the two nuts from the locating pins on the rear of the lamp assembly.
3. Withdraw the lamp assembly rearwards from the outer side.
4. Detach wiring connector from lamp assembly.



5. Remove the three screws from the rear of the lamp assembly.
6. Remove bulb holder from the lamp assembly.



7. Push bulb into socket slightly, rotate anticlockwise, remove and renew bulb.
Turn light (1)
Tail and brake light (2)
Reversing light (3)
Rear fog light, may be on one side only (4)
8. Replace bulb holder in lamp assembly.
9. Replace the three screws on the rear of the lamp assembly.
10. Reattach wiring connector to lamp assembly.
11. Replace lamp assembly from the outer side into original position, ensuring that it is seated correctly.
12. Replace the two nuts onto the locating pins on the rear of the lamp assembly.
13. Install the upper and lower trim panels to the rear pillar.

Crew Cab, Chassis Cab
Turn light, tail and brake light,
reversing light, rear fog light

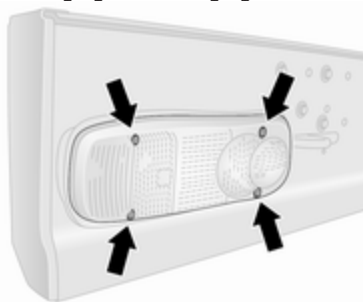

1. Remove the four screws from the lens.
2. Remove lens from the aperture.

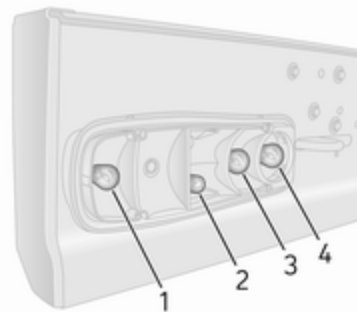

3. Push bulb into socket slightly, rotate anticlockwise, remove and renew bulb.
Turn light (1)
Tail and brake light (2)
Reversing light (3)
Rear fog light, may be on one side only (4)
4. Install lens in aperture and replace the four screws.

Side turn lights

1. Push the lamp assembly to the right and pull at the left-hand side of the lamp assembly to release from the aperture.



2. Detach wiring connector from lamp assembly.
3. Remove bulb holder from lamp assembly by rotating 90° and renew bulb.
4. Install bulb holder in lamp assembly.

5. Attach wiring connector to lamp assembly.
6. Insert lamp assembly into aperture and push to the left to secure.

Mirror turn lights

1. Move the lower mirror assembly from the front to access the screw.
2. Remove the screw using a torx screwdriver.

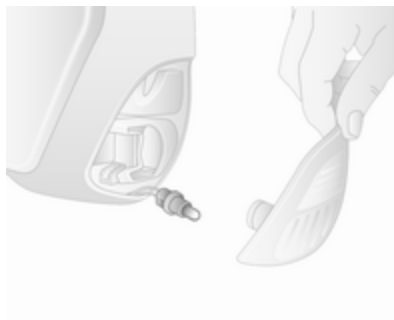

3. Remove bulb holder from the rear of the lower mirror assembly.
4. Renew bulb.

5. Install bulb holder in lower mirror assembly.
6. Replace the screw.

Centre high-mounted brake light



1. Remove cover from the inside of the rear door.
2. Unscrew the nut from the locating pin at the rear of the lamp assembly.



3. Remove the lamp assembly from the aperture on the outer side.
4. Detach wiring connector from lamp assembly.
5. Remove bulb holder from lamp assembly and renew bulb.
6. Install bulb holder in lamp assembly and reattach wiring connector to lamp assembly.
7. Replace lamp assembly into aperture, ensuring that it is seated correctly.

8. Replace the nut onto the locating pin on the rear of the lamp assembly.
9. Install cover on the inside of the rear door.

Number plate light



1. Unclip lamp assembly using a flat blade screwdriver.
2. Detach wiring connector from lamp assembly.
3. Remove lens cover and renew bulb.

4. Install lens cover and attach wiring connector to lamp assembly.
5. Install lamp assembly.

Crew Cab, Chassis Cab



1. Remove the two screws from the lens cover.
2. Remove lens cover and renew bulb.
3. Install the lens cover and replace the two screws.

Interior lights

LED lights

Have lights repaired by a workshop in case of failure.

Front courtesy light



1. Remove lamp assembly using a flat blade screwdriver.
2. Renew bulb.
3. Install lamp assembly.

Load compartment light



1. Remove lamp assembly using a flat blade screwdriver.
2. Detach wiring connector from lamp assembly.
3. Remove lens cover and renew bulb.
4. Install lens cover and attach wiring connector to lamp assembly.
5. Install lamp assembly.

Front door panel light

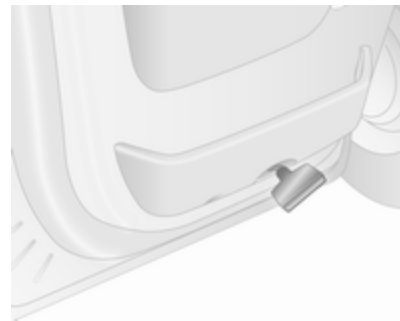

1. Remove lamp assembly using a flat blade screwdriver.
2. Rotate bulb holder anticlockwise to disengage.
3. Renew bulb and insert the bulb holder.
4. Install lamp assembly.

Rear courtesy lights

Have bulbs replaced by a workshop.

Glovebox light

Have bulbs replaced by a workshop.

Instrument panel illumination

Have bulbs replaced by a workshop.

Electrical system

Fuses

Data on the replacement fuse must match the data on the defective fuse.

There are two fuse boxes in the vehicle:

- on the left-hand side of the instrument panel, behind the trim panel
- in the engine compartment located below the coolant expansion tank

Combi

An additional fuse box is located behind a trim panel on the right-hand side of the load compartment, beside the rear door.

Bus

An additional fuse box is located on the lower right-hand side of the load compartment, below the step trim panel.

Before replacing a fuse, turn off the respective switch and the ignition.

A blown fuse can be recognised by its melted wire.

Caution

Do not replace the fuse until the cause of the fault has been remedied.

It is advisable to carry a full set of fuses. Consult a workshop.

Some functions are protected by several fuses.

Fuses may also be inserted without existence of a function.

Notice

Not all fuse box descriptions in this manual may apply to your vehicle.

When inspecting the fuse box, refer to the fuse box label.

Fuse extractor

A fuse extractor may be located in the instrument panel fuse box. The extractor has two sides, each side is designed for a different type of fuses.

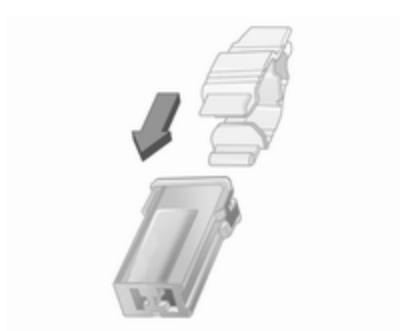
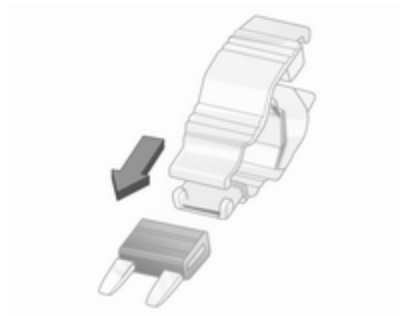

Grab the fuse with the fuse extractor and withdraw the fuse.

Engine compartment fuse box

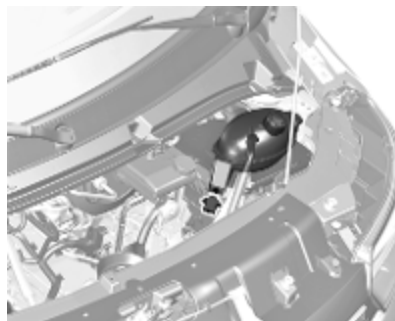

Located below the coolant expansion tank.

Remove the screw to move the coolant expansion tank to the side.

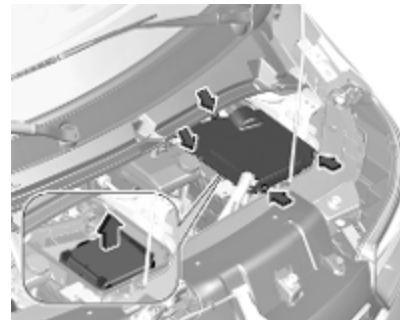

Unscrew the four screws to remove the cover.









Disengage the fuse box cover and remove it.

Some circuits may be protected by several fuses.

Symbol Circuit

	Heated windscreen
	Heating and ventilation system / Air conditioning
	Right side lights
	Left side lights

Symbol Circuit

	Right low beam
	Left low beam
	Front fog lights
	Left high beam
	Right high beam
	ABS
	Windscreen wiper
	Pneumatic suspension









Instrument panel fuse box

Located behind the trim panel. Pull upper part of trim panel to remove.











Do not store any objects behind this panel.

Some circuits may be protected by several fuses.





Symbol Circuit

	Right-hand side light
	Left-hand side light
	Climate control fan
T	Tachograph
	Preheating
	Infotainment system / Seat heating / Driver Information Centre / Audio connections / Alarm
	Hands-free connection
ADP	Additional adaptations
PTO	Power take-off
	Heated seats
	Electronic immobiliser

Symbol Circuit

	Windscreen washer
	Power windows / Body control module
	Right heated rear window
	Left heated rear window
<small>ALIM UCH</small>	Body control module / Power windows / Heating and ventilation system / Air conditioning
STOP	Brake light
	Body control module
	Interior lights / Brake lights
	ABS / Electronic Stability Control
	Horn
	Interior lights
	Turn lights / Rear fog light / Body control module
	Central locking

Symbol Circuit

-  Instrument panel / Diagnostic connector
-  Heated exterior mirrors
-  Power outlet
-  Cigarette lighter

Load compartment fuse box

Combi

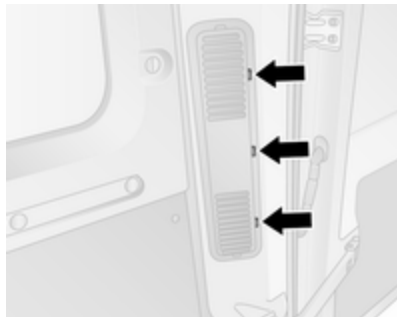

Located behind the trim panel on the right-hand side of the load compartment, beside the rear door.

Using a suitable tool, e.g. a flat-blade screwdriver, unclip the trim panel at the three locations shown in the illustration and remove.

Do not store any objects behind this panel.

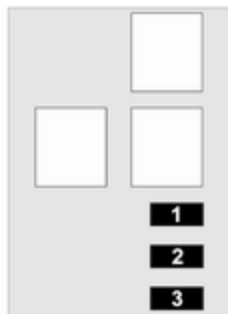

No. Circuit

- 1 Speed 3: additional evaporator
- 2 Speed 2: additional evaporator
- 3 Speed 1: additional evaporator

Bus

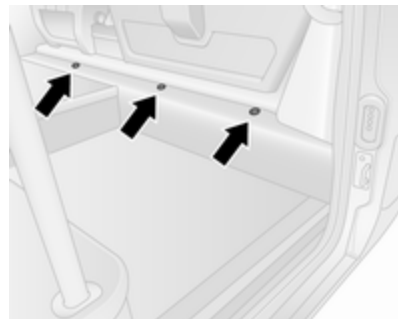

Located below the step trim panel on the lower right-hand side of the load compartment.

Using a suitable tool, e.g. a flat-blade screwdriver, unclip the trim panel at the three locations shown in the illustration and remove.

Do not store any objects behind this panel.



No. Circuit

- 1 Stop-start
- 2 Power sliding door lock electro-magnet
- 3 Power sliding door lock chime
- 4 Speed 2: right-hand evaporator fan
- 5 Speed 2: left-hand evaporator fan
- 6 Speed 1: left-hand evaporator fan
- 7 Left-hand heating
- 8 Speed 3: left-hand evaporator fan
- 9 Condenser fan
- 10 Right-hand heating
- 11 Speed 3: right-hand evaporator fan
- 12 Power sliding door
- 13 Corridor lighting

No. Circuit

- 14 Power side step
- 15 Child safety warning chime
- 16 Speed 1: right-hand evaporator fan

Some circuits may be protected by several fuses.

Vehicle tools

Tools

Vehicles with spare wheel

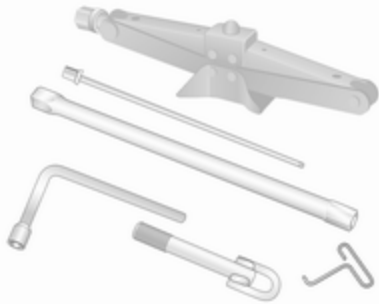

The jack, wheel wrench, adapters (for spare wheel removal), hub cap hook and towing eye are contained in a unit, stowed under the front seat.

Notice

Depending on vehicle, there may be multiple adapters for spare wheel removal.



Vehicles with Rear-wheel drive: A hydraulic jack and a set of extension pieces for use with the jack are also included.

Separately supplied bolts must be used for the temporary spare wheel. These are allowed only for the temporary spare wheel. Refer to an label on the temporary spare wheel.

Wheel changing ⇨ 298.

Spare wheel ⇨ 300.

Towing the vehicle ⇨ 305.

Vehicles without spare wheel



Some vehicles are equipped with a tyre repair kit instead of a spare wheel.

To access this unit, slide the seat fully forwards and fold down the backrest.

If cover is fitted, raise cover slightly and slide it backwards to remove.

Notice

Do not attempt to remove the unit from beneath the seat. Risk of injury.

Tyre repair kit ⇨ 295.

Wheels and tyres

Tyre condition, wheel condition

Drive over edges slowly and at right angles if possible. Driving over sharp edges can cause tyre and wheel damage. Do not trap tyres on the kerb when parking.

Regularly check the wheels for damage. Seek the assistance of a workshop in the event of damage or unusual wear.

We recommend not swapping the front wheels with the rear wheels and vice versa, as this can affect vehicle stability. Always use less worn tyres on the rear axle.

Tyres

Factory-fitted tyres are matched to the chassis and offer optimum driving comfort and safety.

Winter tyres

Winter tyres improve driving safety at temperatures below 7 °C and should therefore be fitted on all wheels.

In accordance with country-specific regulations, affix the maximum speed sticker in the driver's field of view.

Tyre designations

E.g. **215/65 R 16 C 109 R**

- 215** : tyre width, mm
- 65** : cross-section ratio (tyre height to tyre width), %
- R** : belt type: Radial
- RF** : type: RunFlat
- 16** : wheel diameter, inches
- C** : cargo or commercial use
- 88** : load index e.g. 109 is equivalent to approx. 1030 kg
- R** : speed code letter

Speed code letter:

- Q** : up to 100 mph
- S** : up to 112 mph
- T** : up to 118 mph
- H** : up to 130 mph
- V** : up to 150 mph
- W** : up to 168 mph

Choose a tyre appropriate for the maximum speed of your vehicle.

The maximum speed is achievable at kerb weight with driver (75 kg) plus 125 kg payload. Optional equipment could reduce the maximum speed of the vehicle.

Directional tyres

Fit directional tyres such that they roll in the direction of travel. The rolling direction is indicated by a symbol (e.g. an arrow) on the sidewall.

Tyre pressure

Check the pressure of cold tyres at least every 14 days and before any long journey. Do not forget the spare wheel. This also applies to vehicles with tyre pressure monitoring system.

The tyre pressure information label on the driver's door frame indicates the original equipment tyres and the correspondent tyre pressures.

Always inflate tyres to the pressures shown on the label.

Tyre pressures ⇨ 315.

The tyre pressure data refers to cold tyres. It applies to summer and winter tyres.

Always inflate the spare tyre to the highest pressure specified for this tyre size.

Incorrect tyre pressures will impair safety, vehicle handling, comfort and fuel economy and will increase tyre wear.

Tyre pressures differ depending on various options. For the correct tyre pressure value, follow the procedure below:

1. Identify the type of drive.
2. Identify the gross vehicle weight.
3. Identify the respective tyre.

The tyre pressure tables show all possible tyre combinations ↻ 315.

For the tyres approved for your vehicle, refer to the EEC Certificate of Conformity provided with your vehicle or other national registration documents.

The driver is responsible for correct adjustment of tyre pressure.

⚠ Warning

If the pressure is too low, this can result in considerable tyre warm-up and internal damage, leading to tread separation and even to tyre blow-out at high speeds.

⚠ Warning

For specific tyres the recommended tyre pressure as shown in the tyre pressure table may exceed the maximum tyre pressure as indicated on the tyre. Never exceed the maximum tyre pressure as indicated on the tyre.

Temperature dependency

Tyre pressure depends on the temperature of the tyre. During driving, tyre temperature and pressure increase.

Tyre pressure values provided on the tyre information label and tyre pressure chart are valid for cold tyres, which means at 20 °C. The pressure increases by nearly 1.5 psi (10 kPa /

0.1 bar) for a 10 °C temperature increase. This must be considered when warm tyres are checked.

Trailer towing

When towing a trailer with a fully laden vehicle, the tyre pressure must be increased by 20 kPa / 0.2 bar (3.0 psi) and the maximum speed limited to 60 mph.

Trailer towing ↻ 264.

Rear-wheel drive, with twin rear wheels

When inflating the outer tyre, the inflation tube should be passed between the two wheels.

Tyre pressure monitoring system

The tyre pressure monitoring system uses radio and sensor technology to check tyre pressure levels.

Caution

Tyre pressure monitoring system warns only about low tyre pressure condition and does not replace regular tyre maintenance by the driver.

All wheels must be equipped with pressure sensors and the tyres must have the prescribed pressure.

Notice

In countries where the tyre pressure monitoring system is legally required, the use of wheels without pressure sensors will invalidate the vehicle operating permit.

The tyre pressure monitoring system sensors monitor the tyre pressure and transmit tyre pressure readings to a receiver located in the vehicle.

Tyre pressure chart ↗ 315.

Low tyre pressure condition

A detected low tyre pressure condition is indicated by illumination of control indicator (⚠) ↗ 101 and a corresponding message appears in the Driver Information Centre.

If (⚠) illuminates, stop as soon as possible and inflate the tyres as recommended ↗ 315.

After inflating, some driving may be required to update the tyre pressure values in the system. During this time (⚠) may illuminate.

If (⚠) illuminates at lower temperatures and extinguishes after some driving, this could be an indicator for

approaching a low tyre pressure condition. Check tyre pressure of all tyres.

If the tyre pressure must be reduced or increased, switch off ignition.

Only mount wheels with pressure sensors, otherwise (⚠) flashes for several seconds then illuminates continuously together with control indicator (⚠) ↗ 98 and a corresponding message appears in the Driver Information Centre.

A spare wheel or temporary spare wheel is not equipped with pressure sensors. The tyre pressure monitoring system is not operational for these wheels. For the other wheels, the tyre pressure monitoring system remains operational.

Control indicator (⚠) and the corresponding message appears at each ignition cycle until the tyres are inflated to the correct tyre pressure.

Driver Information Centre ↗ 104.

Vehicle messages ↗ 105.

Puncture

A puncture or severely under-inflated tyre is indicated by illumination of control indicator (⚠) together with STOP ⇨ 99 and a corresponding message appears in the Driver Information Centre. Stop vehicle and switch off engine.

Tyre pressure ⇨ 315.

Tyre repair kit ⇨ 295.

Spare wheel ⇨ 300.

Wheel changing ⇨ 298.

Relearn function



After a puncture has been repaired and the driver has inflated the tyres to the correct tyre pressure, the tyre pressure monitoring system needs to recalculate.

Tyre pressure ⇨ 315.

Tyre repair kit ⇨ 295.

During driving, select the tyre pressure menu in the Driver Information Centre by pressing button on end of wiper lever. Press and hold button for approx. five seconds to initialise recalculation. A corresponding message appears in the Driver Information Centre.

Several minutes of driving at a speed above 25 mph may be required to complete the relearn process. The system can only provide limited information during this time.

If problems occur during the relearn process, control indicator (⚠) remains illuminated and a warning message is displayed in the Driver Information Centre.

Driver Information Centre ⇨ 104.

Vehicle messages ⇨ 105.

General information

The use of tyre chains or commercially available liquid tyre repair kits can impair the function of the system. Factory-approved tyre repair kits can be used.

Tyre repair kit ⇨ 295.

Tyre chains ⇨ 294.

External high-power radio equipment could disrupt the tyre pressure monitoring system.

Each time the tyres are replaced, the tyre pressure monitoring system sensors must be dismantled and serviced by a workshop.

Tread depth

Check tread depth at regular intervals.

Tyres should be replaced for safety reasons at a tread depth of 2–3 mm (4 mm for winter tyres).

For safety reasons it is recommended that the tread depth of the tyres on one axle should not vary by more than 2 mm.



The legally permissible minimum tread depth (1.6 mm) has been reached when the tread has worn down as far as one of the tread wear indicators (TWI). Their position is indicated by markings on the sidewall.

Tyres age, even if they are not used. We recommend tyre replacement every 6 years.

Changing tyre and wheel size

If tyres of a different size than those fitted at the factory are used, it may be necessary to reprogramme the nominal tyre pressure and make other vehicle modifications.

After converting to a different tyre size, have the label with tyre pressures replaced.

Tyre pressure monitoring system
 ⇨ 291.

⚠ Warning

The use of unsuitable tyres or wheels may lead to accidents and will invalidate the vehicle operating permit.

Wheel covers

Wheel covers and tyres that are factory approved for the respective vehicle and comply with all of the relevant wheel and tyre combination requirements must be used.

If the wheel covers and tyres used are not factory approved, the tyres must not have a rim protection ridge.

Wheel covers must not impair brake cooling.

⚠ Warning

Use of unsuitable tyres or wheel covers could lead to sudden pressure loss and thereby accidents.

Tyre chains



Tyre chains are only permitted on the drive wheels.

On vehicles with twin rear wheels, tyre chains are only permitted on the outer wheels.

Always use fine mesh chains that add no more than 15 mm to the tyre tread and the inboard sides (including chain lock).

⚠ Warning

Damage may lead to tyre blowout.

Wheel covers on steel wheels may come into contact with parts of the chains. In such cases, remove the wheel covers.

Tyre chains may only be used at speeds up to 30 mph and, when travelling on roads that are free of snow, they may only be used for brief periods since they are subject to rapid wear on a hard road and may snap.

The use of tyre chains is not permitted on the temporary spare wheel or on wheels of a different size than those fitted at the factory.

Tyre repair kit

Minor damage to the tyre tread can be repaired with the tyre repair kit.

Do not remove foreign bodies from the tyres.

Tyre damage exceeding 4 mm or that is at the tyre's sidewall near the rim cannot be repaired with the tyre repair kit.

⚠ Warning

Do not drive faster than 50 mph.
Do not use for a lengthy period.
Steering and handling may be affected.

If the vehicle has a flat tyre:

Apply the parking brake and engage neutral (manual transmission) or **N** (manual transmission automated).

The tyre repair kit is located under the front seat. Slide seat forwards fully and fold backrest down to access kit.

1. Take the tyre repair kit out from under the front seat.
2. Remove the compressor.

3. Remove the power supply lead(s) and air hose from the stowage compartments on the underside of the compressor.

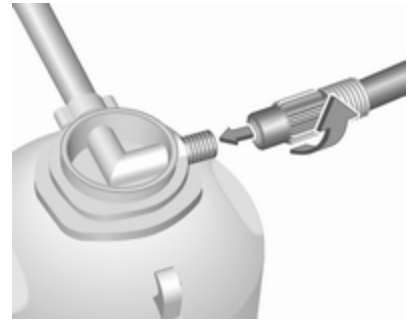

4. Screw the compressor air hose to the connection on the sealant bottle.
5. Fit the sealant bottle into the retainer on the compressor.
Set the compressor near the tyre in such a way that the sealant bottle is upright.
6. Unscrew valve cap from defective tyre.

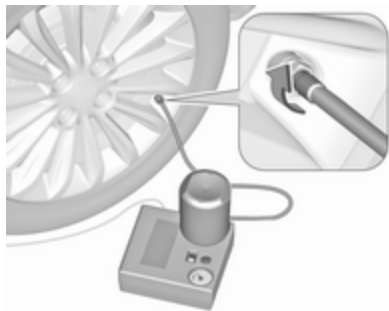

7. Screw the sealant filler hose to the tyre valve.
8. The rocker switch on the compressor must be set to position **O**.

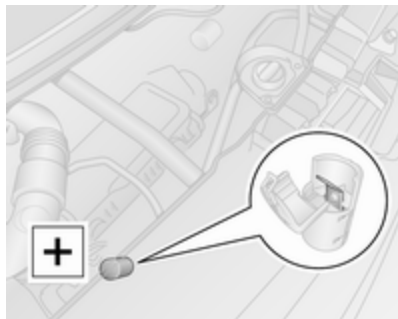

9. Connect the red **+** power supply lead on the compressor to the jump start terminal ⇨ 303.

Notice

Depending on model, the jump start terminal may be located at the left-hand or right-hand side of the engine compartment.

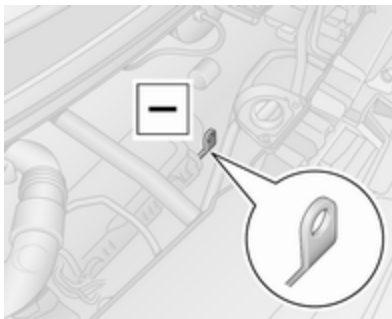

10. Connect the black **-** power supply lead to a vehicle grounding point, e.g. the engine block or an engine mounting bolt.

Notice

Depending on tyre repair kit type, it may be necessary to connect the single power supply lead to the

power outlet or cigarette lighter socket.

For this type, the red **+** and black **-** power supply leads will not be present.

To avoid discharging the battery, we recommend running the engine.

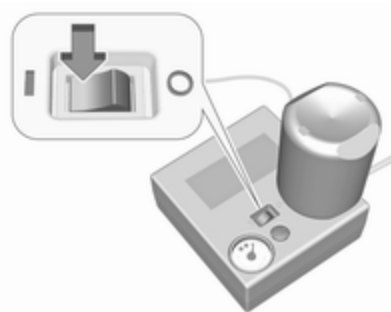

11. Set the rocker switch on the compressor to position **I**. The tyre is filled with sealant.
12. The compressor pressure gauge briefly indicates up to 6 bar. Then the pressure starts to drop.
13. All of the sealant is pumped into the tyre. Then the tyre is inflated.



14. The prescribed tyre pressure should be obtained within 10 minutes.

Tyre pressure ⇨ 315.

When the correct pressure is obtained, turn off the compressor by setting rocker switch to position **O**.

If the prescribed tyre pressure is not obtained within 10 minutes, remove the tyre repair kit. Move the vehicle one tyre rotation (approx. 2 m). Reattach the tyre repair kit and continue the filling procedure for 10 minutes. If the prescribed tyre pressure is still not obtained, the tyre is too badly

damaged. Seek the assistance of a workshop.

Drain excess tyre pressure with the button beside the pressure indicator.

Do not run the compressor for longer than 10 minutes.

15. Detach the tyre repair kit.
16. Remove any excess sealant using a cloth.
17. Take the label indicating maximum permitted speed from the tyre repair kit and affix in the driver's field of view.
18. Screw the sealant filler hose to the free connection on the sealant bottle. This prevents sealant from escaping. Store the sealant bottle in the plastic bag. Stow tyre repair kit under the front seat.

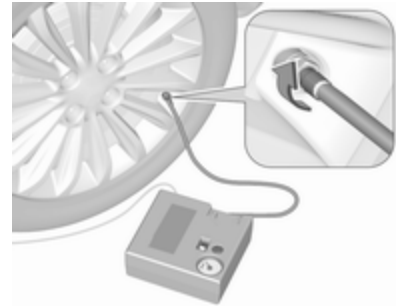

19. Continue driving immediately so that the sealant is evenly distributed throughout the tyre. After driving approx. 6 miles, but no more than 10 minutes, stop and check tyre pressure using the compressor. Screw compressor air hose directly onto tyre valve and compressor when doing this.
20. If the tyre pressure is more than 3.1 bar, set it to the correct value. Repeat the procedure until there is no more loss of pressure.
If the tyre pressure has fallen below 3.1 bar, the vehicle must

not be driven. Seek the assistance of a workshop.

21. Stow tyre repair kit under the front seat.

Notice

The driving characteristics of the repaired tyre are severely affected, therefore have this tyre replaced.

If unusual noise is heard or the compressor becomes hot, turn compressor off for at least 30 minutes.

The built-in safety valve opens at a pressure of 7 bar (102 psi).

Note the expiry date of the kit. After this date its sealing capability is no longer guaranteed. Pay attention to storage information on sealant bottle.

Replace the used sealant bottle. Dispose of the bottle as prescribed by applicable laws.

The compressor and sealant can be used from approx. -30 °C.

Wheel changing

Make the following preparations and observe the following information:

- Park the vehicle on a level, firm and non-slippery surface. The front wheels must be in the straight-ahead position.
- Apply the parking brake and engage first gear or reverse gear (manual transmission) or **N** (manual transmission automated).
- Switch off the air suspension system ⇨ 230.
- Remove the spare wheel ⇨ 300.
- Never change more than one wheel at a time.
- Use the jack only to change wheels in case of puncture, not for seasonal winter or summer tyre change.
- The jack is maintenance-free.
- If the ground on which the vehicle is standing is soft, a solid board (max. 1 cm thick) should be placed under the jack.

- No people or animals may be in the vehicle when it is jacked-up.
- Never crawl under a jacked-up vehicle.
- Do not start the engine when the vehicle is raised on the jack.
- Clean wheel bolts / nuts and their threads before mounting the wheel.

Warning

Do not grease wheel bolt, wheel nut and wheel nut cone.

1. Remove the wheel cover using the hook supplied.

Vehicle tools ⇨ 289.

Depending on vehicle, first remove the bolt / nut covers by hand then remove the wheel cover, or press wheel cover at the points indicated by the arrows and turn to release.

Rear-wheel drive, with twin rear wheels: Remove the tyre valve extender from the inner rear wheel.

2. Install the wheel wrench (depending on vehicle, attach wheel wrench to adapters) ensuring that it is located securely and loosen each wheel bolt / nut by half a turn.

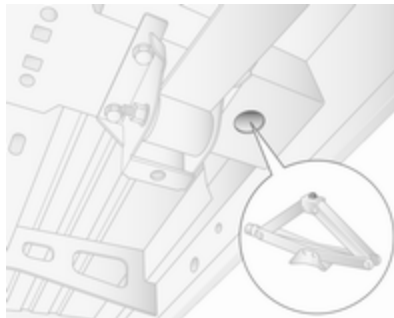

3. Vehicles with Front-wheel drive:
If equipped, attached heightener to lifting pad when changing a front wheel.

Raise vehicle by placing lifting pad spigot of the jack (vehicle tools ⇨ 289) under the jacking hole located nearest the wheel concerned.

Ensure the jack is positioned correctly. The jack base must be on the ground directly below the jacking hole in a manner that prevents it from slipping.

Attach wheel wrench onto the jack and raise the vehicle by turning

the wrench until the wheel is clear of the ground.

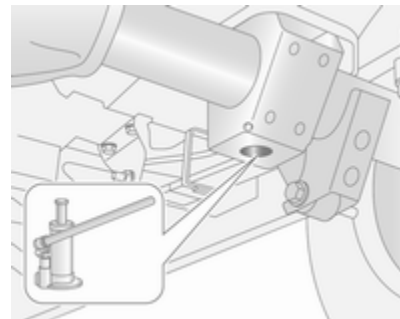

Vehicles with Rear-wheel drive:

Pay attention to the operating instructions supplied with the hydraulic jack (vehicle tools ⇨ 289) and assemble the parts required as specified.

Position the adapter at the jacking hole located nearest the wheel concerned.

Ensure the jack is positioned correctly. The jack head must be level with the jacking hole. Pump the jack by pressing the wheel wrench / adapters, to position the base plate correctly.

Raise the vehicle by pressing the wheel wrench until the wheel is clear of the ground.

4. Unscrew wheel bolts / nuts completely and wipe clean with a cloth.
Put wheel bolts / nuts somewhere where the threads will not be soiled.
5. Change the wheel.
6. Screw in the wheel bolts / nuts.
Separately supplied bolts must be used for the temporary spare wheel. These are allowed only for the temporary spare wheel. Refer to an label on the temporary spare wheel.
7. Lower vehicle.
8. Install the wheel wrench (depending on vehicle, attach wheel wrench to adapters) ensuring that it is securely located and tighten each wheel bolt / nut in a crosswise sequence.
Tightening torque is: 172 Nm (Front-wheel drive), 235 Nm

(Rear-wheel drive with twin rear wheels), 264 Nm (Rear-wheel drive with single rear wheels).

9. Refit wheel cover.
Rear-wheel drive, with twin rear wheels: Install the tyre valve extender to the inner rear wheel before refitting the wheel cover.
- Notice**
If applicable, fit anti-theft bolts nearest the tyre valve (otherwise it may not be possible to refit the wheel cover).
10. Stow the replaced wheel ⇨ 300 and the vehicle tools ⇨ 289.
 11. Have the new wheel balanced on the vehicle. Check the tyre pressure of the installed tyre ⇨ 315 and also the wheel bolt / nut torque as soon as possible.
Have the defective tyre renewed or repaired.

Spare wheel

The spare wheel can be classified as a temporary spare wheel depending on the size compared to the other

mounted wheels and country regulations. In this case a permissible maximum speed applies, even though no label at the spare wheel indicates this.

Caution
The use of a spare wheel that is smaller than the other wheels or in combination with winter tyres could affect driveability. Have the defective tyre replaced as soon as possible.

The spare wheel is held under the vehicle frame using a winch and secured by tightening a cable using the wheel wrench and adapters (depending on vehicle).

It may be necessary to jack the vehicle up to gain access to the spare wheel on a fully loaded vehicle with a flat rear tyre.



To release the spare wheel, loosen cable by connecting the wheel wrench and adapters (depending on vehicle) to the slot position illustrated and lower the wheel fully by turning wrench clockwise.

Caution

Only use the wheel wrench and adapters (depending on vehicle) to lower the spare wheel.

The use of pneumatic tools is prohibited. This may result in damage to the winch cable and equipment.



Place wheel upright, unclip retainer from wheel rim and release the wheel from the cable and connected retainer by routing these components through the centre of the wheel.

Twin rear wheel vehicles have an additional mounting plate attached to the spare wheel. Before using the wheel, undo the nut and remove the mounting plate.

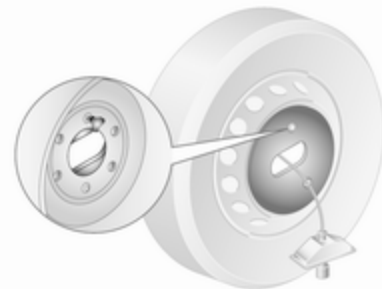

When reinstalling a spare wheel, first attach the mounting plate (twin rear wheel vehicles) and secure with the nut.

Place wheel upright, then route the cable and connected retainer from the front of the wheel (side with tyre valve) and through the centre of the wheel. Attach the retainer and clip it into place, ensuring it is correctly positioned and that the front of the wheel (side with tyre valve) will be facing upwards when reinstalled.

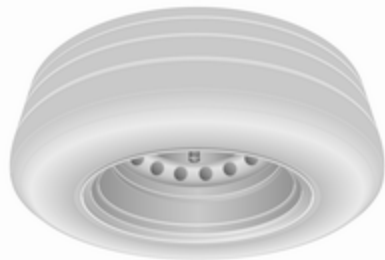

Place wheel below the vehicle frame, directly beneath the winch mechanism.



Then tighten cable using the wheel wrench and adapters by connecting to the slot position illustrated above and turning wrench anticlockwise until the wheel is secured in the fully raised position.

Notice

Do not place a wheel with aluminium rim under the vehicle frame.

⚠ Warning

Ensure the front of the wheel (side with tyre valve) is facing upwards when the spare wheel is reinstalled below the vehicle frame.

Temporary spare wheel

Caution

The use of a spare wheel that is smaller than the other wheels or in combination with winter tyres could affect driveability. Have the defective tyre replaced as soon as possible.

Only mount one temporary spare wheel. Do not drive faster than 50 mph. Take curves slowly. Do not use for a long period of time.

Separately supplied bolts must be used for the temporary spare wheel. These are allowed only for the temporary spare wheel. Refer to an label on the temporary spare wheel. Tyre chains ⇨ 294.

Summer and winter tyres

If you use winter tyres, the spare wheel may still be fitted with a summer tyre.

If you use the spare wheel when it is fitted with a summer tyre the vehicle's driveability may be affected, especially on slippery road surfaces.

Directional tyres

Fit directional tyres such that they roll in the direction of travel. The rolling direction is indicated by a symbol (e.g. an arrow) on the sidewall.

The following applies to tyres fitted opposing the rolling direction:

- Driveability may be affected. Have the defective tyre renewed or repaired as soon as possible and fit it instead of the spare wheel.
- Do not drive faster than 50 mph.
- Drive particularly carefully on wet and snow-covered road surfaces.

Jump starting

The jump start terminal is located in the engine compartment.

A vehicle with a discharged vehicle battery can be started using jump leads and the vehicle battery of another vehicle.

Do not start with a quick charger.

Warning

Be extremely careful when starting with jump leads. Any deviation from the following instructions can lead to injuries or damage caused by battery explosion or damage to the electrical systems of both vehicles.

Warning

Avoid contact of the battery with eyes, skin, fabrics and painted surfaces. The fluid contains sulphuric acid which can cause injuries and damage in the event of direct contact.

Caution

The air suspension system must be switched off prior to jump starting.

Air suspension ⇨ 230.

- Never expose the vehicle battery to naked flames or sparks.
- A discharged vehicle battery can already freeze at a temperature of 0 °C. Defrost the frozen vehicle battery before connecting jump leads.
- Wear eye protection and protective clothing when handling a vehicle battery.
- Use a booster battery with the same voltage (12 V). Its capacity (Ah) must not be much less than that of the discharged vehicle battery.
- Use jump leads with insulated terminals and a cross section of at least 25 mm².
- Do not disconnect the discharged battery from the vehicle.

- Switch off all unnecessary electrical consumers.
- Switch off the air suspension system ↻ 230.
- Do not lean over the vehicle battery during jump starting.
- Do not allow the terminals of one lead to touch those of the other lead.
- The vehicles must not come into contact with each other during the jump starting process.
- Apply the parking brake and engage neutral (manual transmission) or **N** (manual transmission automated).

Jump start terminal



In the event of a discharged vehicle battery, the jump start terminal enables the vehicle to be started without the need to access the battery inside the vehicle.

The jump start terminal is located in the engine compartment and identified by a "+" sign on the red insulating cover. Lift the red insulating cover to access the terminal connector.

Ensure the red insulating cover is latched back into position when not in use.

Jump starting procedure

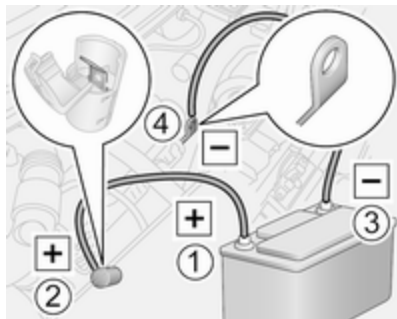

Depending on model, the jump start terminal may be located at the left-hand or right-hand side of the engine compartment.

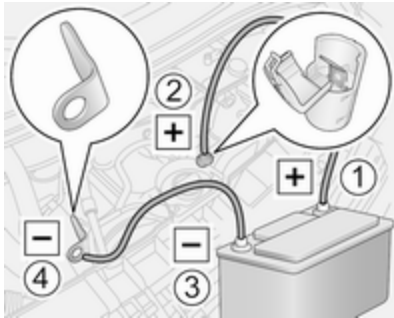

Lead connection order:

1. Connect the red lead to the positive terminal (1) of the booster battery.
2. Connect the other end of the red lead to the jump start terminal (2) of the vehicle with the discharged vehicle battery.
3. Connect the black lead to the negative terminal (3) of the booster battery.
4. Connect the other end of the black lead to a vehicle grounding point (4), such as the engine block or an engine mounting bolt. Connect as

far away from the discharged vehicle battery as possible, however at least 60 cm.

Route the leads so that they cannot catch on rotating parts in the engine compartment.

To start the engine:

1. Start the engine of the vehicle providing the jump start.
2. After 5 minutes, start the other engine. Start attempts should be made for no longer than 15 seconds at an interval of 1 minute.
3. Allow both engines to idle for approx. 3 minutes with the leads connected.
4. Switch on electrical consumers (e.g. headlights, heated rear window) of the vehicle receiving the jump start.
5. Reverse above sequence exactly when removing leads.

Towing

Towing the vehicle

The towing eye and wheel wrench are stowed with the vehicle tools ⇨ 289.



Disengage the cover using a suitable tool and remove.

Screw the towing eye clockwise into the front towing point and tighten fully using the wheel wrench.

Attach a tow rope – or better still a tow rod – to the towing eye, never to the bumper or front suspension units.

Caution

Do not tow the vehicle from the rear. The front towing eye must only be used for towing and not recovering a vehicle.

Switch on ignition to permit operation of brake lights, horn and windscreen wipers, and move the steering wheel slightly to release the steering wheel lock.

Switch off the air suspension system ⇨ 230.

Caution

Deactivate the driver assistance systems like active emergency braking ⇨ 252, otherwise the vehicle may automatically brake during towing.

Move the selector lever to neutral.
Release the parking brake.

Caution

Vehicles with manual transmission automated: If neutral cannot be selected, the vehicle must only be towed with the drive wheels raised off the ground.

The vehicle should always be towed with the ignition switched off.

Manual transmission automated ⇨ 240.

Caution

Drive slowly. Do not drive jerkily. Excessive tractive force can damage the vehicle.

When the engine is not running, considerably more force is needed to brake and steer.

To prevent the entry of exhaust fumes from the towing vehicle, switch on the air recirculation system ⇨ 208 and close the windows.

Seek the assistance of a workshop.

After towing, unscrew the towing eye and refit the cover.

Towing another vehicle



Attach a tow rope – or better still a tow bar – to the rear towing eye, never to the rear axle and suspension units.

Caution

The rear towing eye must only be used for towing and not recovering a vehicle.

Caution

Drive slowly. Do not drive jerkily. Excessive tractive force can damage the vehicle.

Appearance care**Exterior care****Locks**

The locks are lubricated at the factory using a high quality lock cylinder grease. Use de-icing agent only when absolutely necessary, as this has a degreasing effect and impairs lock function. After using a de-icing agent, have the locks regreased by a workshop.

Washing

The paintwork of your vehicle is exposed to environmental influences. Wash and wax your vehicle regularly. When using automatic vehicle washes, select a programme that includes waxing. Restrictions for filmed or matt painted body parts or decor tapes, see "Polishing and waxing".

Bird droppings, dead insects, resin, pollen and the like should be cleaned off immediately, as they contain aggressive constituents which can cause paint damage.

If using a vehicle wash, comply with the vehicle wash manufacturer's instructions. The windscreen wipers must be switched off and the exterior mirrors must be folded in. Remove antenna and external accessories such as roof racks etc.

If you wash your vehicle by hand, make sure that the insides of the wheel housings are also thoroughly rinsed out.

Clean edges and folds on opened doors and the bonnet as well as the areas they cover.

Clean bright metal mouldings with a cleaning solution approved for aluminium to avoid damages.

Caution

Always use a cleaning agent with a pH value of four to nine.

Do not use cleaning agents on hot surfaces.

Have the door hinges of all doors greased by a workshop.

Do not clean the engine compartment with a steam-jet or high-pressure jet cleaner.

Thoroughly rinse and leather-off the vehicle. Rinse leather frequently. Use separate leathers for painted and glass surfaces: remnants of wax on the windows will impair vision.

Exterior lights

Headlight and other light covers are made of plastic. Do not use any abrasive or caustic agents, do not use an ice scraper, and do not clean them dry.

Polishing and waxing

Wax the vehicle regularly (at the latest when water no longer beads). Otherwise, the paintwork will dry out.

Polishing is necessary only if the paint has become dull or if solid deposits have become attached to it.

Paintwork polish with silicone forms a protective film, making waxing unnecessary.

Unpainted plastic body parts must not be treated with wax or polishing agents.

Matt filmed body parts or decor tapes must not be polished, to avoid gleaming. Do not use hot wax programmes in automatic car washes if the vehicle is equipped with these parts.

Matt painted decor parts, e.g. mirror housing cover, must not be polished. Otherwise these parts would become a gleam or the colour would be dissolved.

Windows and windscreen wiper blades

Switch off wipers before handling in their areas.

Use a soft lint-free cloth or chamois leather together with window cleaner and insect remover.

When cleaning the rear window from inside, always wipe in parallel to the heating element to prevent damage.

For mechanical removal of ice, use a sharp-edged ice scraper. Press the scraper firmly against the glass so that no dirt can get under it and scratch the glass.

Remove dirt residues from smearing wiper blades by using a soft cloth and window cleaner. Also make sure to remove any residues such as wax, insect residues and similar from the window.

Wheels and tyres

Do not use high-pressure jet cleaners.

Clean rims with a pH-neutral wheel cleaner.

Rims are painted and can be treated with the same agents as the body.

Paintwork damage

Rectify minor paintwork damage with a touch-up pen before rust forms. Have more extensive damage or rust areas repaired by a workshop.

Underbody

Some areas of the vehicle underbody have a PVC undercoating while other critical areas have a durable protective wax coating.

After the underbody is washed, check the underbody and have it waxed if necessary.

Bitumen / rubber materials could damage the PVC coating. Have underbody work carried out by a workshop.

Before and after winter, wash the underbody and have the protective wax coating checked.

Towing equipment

Do not clean the coupling ball bar with a steam-jet or high-pressure jet cleaner.

Interior care

Interior and upholstery

Only clean the vehicle interior, including the instrument panel fascia and panelling, with a dry cloth or interior cleaner.

Clean leather upholstery with clear water and a soft cloth. In case of heavy soiling, use leather care.

The instrument cluster and the displays should only be cleaned using a soft damp cloth. If necessary use a weak soap solution.

Clean fabric upholstery with a vacuum cleaner and brush. Remove stains with an upholstery cleaner.

Clothing fabrics may not be colourfast. This could cause visible discolourations, especially on light-coloured upholstery. Removable stains and discolourations should be cleaned as soon as possible.

Clean seat belts with lukewarm water or interior cleaner.

Caution

Close Velcro fasteners as open Velcro fasteners on clothing could damage seat upholstery.

The same applies to clothing with sharp-edged objects, like zips or belts or studded jeans.

Plastic and rubber parts

Plastic and rubber parts can be cleaned with the same cleaner as used to clean the body. Use interior cleaner if necessary. Do not use any other agent. Avoid solvents and petrol in particular. Do not use high-pressure jet cleaners.

Service and maintenance

General information	310
Service information	310
Recommended fluids, lubricants and parts	311
Recommended fluids and lubricants	311

General information

Service information

In order to ensure economical and safe vehicle operation and to maintain the value of your vehicle, it is of vital importance that all maintenance work is carried out at the proper intervals as specified.

The detailed, up-to-date service schedule for the vehicle is available at the workshop.

Service display ⇨ 93.

Engine identification ⇨ 314.

European service intervals - except Bus

Maintenance of your vehicle is required every 25,000 miles or after two years, whichever occurs first, unless otherwise indicated by the service display.

A shorter service interval can be valid for severe driving behaviour, e.g. for taxis and police vehicles.

European service intervals - Bus only

Maintenance of your vehicle is required every 20,000 miles or after one year, whichever occurs first, unless otherwise indicated by the service display.

The European service intervals are valid for the following countries:

Andorra, Austria, Belgium, Croatia, Czech Republic, Denmark, Estonia, Finland, France, Germany, Greece, Hungary, Iceland, Ireland, Italy, Latvia, Liechtenstein, Lithuania, Luxembourg, Netherlands, Norway, Poland, Portugal, Slovakia, Slovenia, Spain, Sweden, Switzerland, United Kingdom.

Confirmations

Confirmation of service is recorded in the Service and warranty booklet. The date and mileage is completed with the stamp and signature of the servicing workshop.

Make sure that the Service and warranty booklet is completed correctly as continuous proof of

service is essential if any warranty or goodwill claims are to be met, and is also a benefit when selling the vehicle.

Service display

The service interval is based on several parameters depending on usage.

The service display, located in the Driver Information Centre, indicates when the next service is due. Seek the assistance of a workshop.

Service display ⇨ 93.

Recommended fluids, lubricants and parts

Recommended fluids and lubricants

Only use products that meet the recommended specifications.

Warning

Operating materials are hazardous and could be poisonous. Handle with care. Pay attention to information given on the containers.

Engine oil

Engine oil is identified by its quality and its viscosity. Quality is more important than viscosity when selecting which engine oil to use. The oil quality ensures e.g. engine cleanliness, wear protection and oil aging control, whereas viscosity grade gives information on the oil's thickness over a temperature range.

Select the appropriate engine oil based on its quality and on the minimum ambient temperature ⇨ 315.

Topping up engine oil

Caution

In case of any spilled oil, wipe it up and dispose of it properly.

Engine oils of different manufacturers and brands can be mixed as long as they comply with the required engine oil quality and viscosity.

Select the appropriate engine oil based on its quality and on the minimum ambient temperature ⇨ 315.

Additional engine oil additives

The use of additional engine oil additives could cause damage and invalidate the warranty.

Engine oil viscosity grades

The SAE viscosity grade gives information of the thickness of the oil.

Multigrade oil is indicated by two figures, e.g. SAE 5W-30. The first figure, followed by a W, indicates the low temperature viscosity and the second figure the high temperature viscosity.

Select the appropriate viscosity grade depending on the minimum ambient temperature ↗ 315.

All of the recommended viscosity grades are suitable for high ambient temperatures.

Coolant and antifreeze

Use only silicate-free long life coolant (LLC) antifreeze approved for the vehicle. Consult a workshop.

The system is factory filled with coolant designed for excellent corrosion protection and frost protection down to approx. -28 °C. This concentration should be maintained all year round. The use of additional coolant additives that intend to give additional corrosion protection or seal against minor leaks can cause function problems. Liability

for consequences resulting from the use of additional coolant additives will be rejected.

Washer fluid

Use only washer fluid approved for the vehicle to prevent damage of wiper blades, paintwork, plastic and rubber parts. Consult a workshop.

Brake fluid

Over time, brake fluid absorbs moisture which will reduce braking effectiveness. The brake fluid should therefore be replaced at the specified interval.

AdBlue

Only use AdBlue to reduce the nitrogen oxides in the exhaust emission ↗ 233.

Technical data

Vehicle identification	313
Vehicle identification number ..	313
Identification plate	314
Engine identification	314
Vehicle data	315
Recommended fluids and lubricants	315
Capacities	315
Tyre pressures	316

Vehicle identification

Vehicle identification number



The vehicle identification number (VIN) is visible through the windscreen.



The vehicle identification number is also displayed behind a removable plastic cover on the front right hand door step. Unclip the covers using a flat blade screwdriver to access.

Identification plate



The identification plate is located on the right hand door pillar.

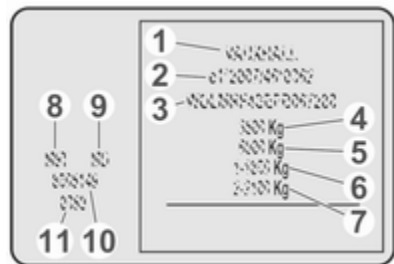

Information on identification plate:

- 1 : manufacturer's name
- 2 : type approval number
- 3 : vehicle identification number
- 4 : permissible gross vehicle weight rating in kg
- 5 : permissible gross train weight in kg
- 6 : maximum permissible front axle load in kg
- 7 : maximum permissible rear axle load in kg
- 8 : engine type
- 9 : engine identification code
- 10 : fabrication number
- 11 : vehicle paint code

Notice

The identification plate on your vehicle may differ from the illustration shown.

The combined total of front and rear axle loads must not exceed the permissible gross vehicle weight.

Vehicle's kerb weight depends on the specification of the vehicle, e.g. optional equipment and accessories. Refer to the EEC Certificate of

Conformity provided with your vehicle or other national registration documents.

The technical data is determined in accordance with European Community standards. We reserve the right to make modifications. Specifications in the vehicle documents always have priority over those given in this manual.

Engine identification

Movano has diesel engines with four cylinders and a piston displacement of 2298 cm³. The engine identifier code starts with M9T and identifies the power and the emission category. It is part of the identification plate, stamped on the engine cylinder block and on a label attached to the timing chain cover, depending on variant.

For further technical data, refer to the EEC Certificate of Conformity provided with your vehicle or other national registration documents.

Vehicle data

Recommended fluids and lubricants

Required engine oil quality

Engine oil quality: Europe

dexos 2 ✓

For countries with International service interval ⇨ 310, you may use the engine oil qualities listed below:

Engine oil quality: International

dexos 2 ✓

ACEA C3 ✓
engines with diesel particle filter

ACEA A3/B4 ✓
engines without diesel particle filter

Engine oil viscosity grades

Ambient temperature

down to -25 °C SAE 0W-30 or SAE 0W-40

SAE 5W-30 or SAE 5W-40

below -25 °C SAE 0W-30 or SAE 0W-40

Capacities

Fuel tank

Fuel tank, nominal capacity [l]

80 or 105

AdBlue tank

AdBlue, nominal capacity [l]

22.5

Tyre pressures

Front-wheel drive		Front	Rear
Gross Vehicle Weight	Tyre	[kPa/bar] (psi)	[kPa/bar] (psi)
2800	215/65 R16 C 109/107R	340/3.4 (49)	360/3.6 (52)
3300	215/65 R16 C 109/107R	360/3.6 (52)	430/4.3 (62)
3500	225/65 R16 C 112/110R	380/3.8 (55)	460/4.6 (68)
3900	225/65 R16 C 112/110R	380/3.8 (55)	460/4.6 (68)

Rear-wheel drive, with single rear wheels		Front	Rear
Gross Vehicle Weight	Tyre	[kPa/bar] (psi)	[kPa/bar] (psi)
3500	235/65 R16 C 115/113R	360/3.6 (52)	450/4.5 (65)

Rear-wheel drive, with twin rear wheels		Front	Rear
Gross Vehicle Weight	Tyre	[kPa/bar] (psi)	[kPa/bar] (psi)
3500	195/75 R16 C 107/105R	420/4.2 (61)	420/4.2 (61)
4500	195/75 R16 C 107/105R	420/4.2 (61)	420/4.2 (61)

Customer information

Customer information	317
Declaration of conformity	317
REACH	321
Registered trademarks	321
Vehicle data recording and privacy	321
Event data recorders	321
Radio Frequency Identification (RFID)	324

Customer information

Declaration of conformity

Radio transmission systems

This vehicle has systems that transmit and / or receive radio waves subject to Directive 2014/53/EU. The manufacturers of the systems listed below declare conformity with Directive 2014/53/EU. The full text of the EU declaration of conformity for each system is available at the following internet address: www.opel.com/conformity.

Importer is

Opel / Vauxhall, Bahnhofplatz,
65423 Ruesselsheim am Main,
Germany.

Radio remote control receiver

Visteon Electronics

04 Rue Nelson Mandela, Zone
Industrielle Borj Cedria, 2055 Bir El
Bey, Tunisia

Operation frequency: 433 MHz

Maximum output: 10 mW ERP

Radio remote control transmitter

Visteon Electronics

04 Rue Nelson Mandela, Zone
Industrielle Borj Cedria, 2055 Bir El
Bey, Tunisia

Operation frequency: 433 MHz

Maximum output: 10 mW ERP

Electronic key transmitter

ALPS ELECTRIC EUROPE GmbH

Ohmstrasse 4, 85716
Unterschleissheim, Germany

Operation frequency: 433 MHz

Maximum output: 10 mW ERP

Immobiliser

Visteon Electronics

04 Rue Nelson Mandela, Zone
Industrielle Borj Cedria, 2055 Bir El
Bey, Tunisia

Operation frequency: 125 kHz

Maximum output:
42 dB μ A/m @ 10 m

Immobiliser

ALPS ELECTRIC EUROPE GmbH

Ohmstrasse 4, 85716
Unterschleissheim, Germany
Operation frequency: 125 kHz
Maximum output:
42 dB μ A/m @ 10 m

**Infotainment system NAVI 80
IntelliLink**

TomTom Int'l BV
De Ruijterkade 154, 1011 AC
Amsterdam, The Netherlands
Operation frequency:
2400 - 2483.5 MHz

Maximum output: 100 mW EIRP

**Infotainment system NAVI 50
IntelliLink**

LG Electronics
LG Electronics European Shared
Service Center B.V., Krijgsman 1,
1186 DM Amstelveen, The
Netherlands
Operation frequency: 2.4 GHz
Maximum output: 100 mW EIRP

Infotainment system Radio 15
Visteon Electronics

04 Rue Nelson Mandela, Zone
Industrielle Borj Cedria, 2055 Bir El
Bey, Tunisia
Operation frequency:
2400 – 2483,5 MHz
Maximum output: 100 mW EIRP

**Parking heater remote control
receiver**

Eberspaecher Climate Control
Systems GmbH & Co. KG
Eberspaecherstrasse 24, 73730
Esslingen, Germany
Operation frequency: N/A
Maximum output: N/A

**Parking heater remote control
transmitter**

Eberspaecher Climate Control
Systems GmbH & Co. KG
Eberspaecherstrasse 24, 73730
Esslingen, Germany
Operation frequency: 434,6 MHz
Maximum output: 10dBm

Telematics control unit
Continental Automotive

1 Rue de Clairefontaine, 78120
Rambouillet, France
Operation frequency:
2400 – 2483,5 MHz
Maximum output: 100 mW EIRP

Telematics display
MASTernaut INTERNATIONAL
4 rue Charles Cros 27400 Louviers,
France

Operation frequency (MHz)	Maximum output (dBm)
900 MHz	33 dBm
1800 MHz	30 dBm

Tyre pressure monitoring receiver
Schrader Electronics
Trooperslane Industrial Estate, 2
Meadowbank Rd, Carrickfergus
BT38 8YF, United Kingdom
Operation frequency: N/A
Maximum output: N/A

Tyre pressure sensors
Schrader Electronics

Trooperslane Industrial Estate, 2
Meadowbank Rd, Carrickfergus
BT38 8YF, United Kingdom

Operation frequency:
433.05 – 434.79 MHz

Maximum output: 10 mW ERP

Tyre pressure sensors module

Visteon Electronics

04 Rue Nelson Mandela, Zone
Industrielle Borj Cedria, 2055 Bir El
Bey, Tunisia

Operation frequency: N/A

Maximum output: N/A

Radar systems

Country-specific Declarations of
Conformity for radar systems are
shown on the following page:

European Union

EC Directive: 1999/5/EC

Manufacturer: Delphi Electronics & Safety

Model / Type Designation: L2C0038TR

Description / Intended Use:

Electronically Scanned Radar (ESR),
a 76.5GHz adaptive cruise control system
radar fitted to motor vehicles at vehicle
manufacture

Applied Standards:

47 CFR Part 15

CEPT ERC Recommendation 70-03

EN 60950

EN 301 091

European Commission Directive

2006/28/EC

I declare that the product referenced
above is in compliance with the essential
requirements and other relevant
provisions of Directive 1999/5/EC, on the
approximation of the laws of the member
states relating to Directive 1999/5/EC.

Brazil

Modelo: L2C0038TR



1071-10-3451



0107897843800248

Este equipamento
opera em caráter
secundário, isto é,
não tem direito a
proteção contra
interferência

prejudicial, mesmo de estações do
mesmo tipo, e não pode causar
interferência a sistemas operando em
caráter primário

Indonesia

14785/POSTEL/2010

1982

Jordan

Type Approval No.: TRC/LPD/2009/87

Equipment Type: Low Power Device (LPD)

Malaysia

Approval #: B 05358

Moldova

8526

Morocco

AGREE PAR L'ANRT MAROC

Numéro d'agrément :

MR 4838 ANRT 2009

Date d'agrément : 22/5/2009

Singapore

Complies with

IDA Standards

DA105753

South Africa

TA-2009/163

APPROVED

South Korea

방송통신위원회

인용번호 : KCC-0904PRL200908TR

Taiwan

◎ CCAB09LP4590T3

UAE

TRA

REGISTERED No:

0018923/09

DEALER No:

DA0047809/10

United States of America and Canada

Model / FCC ID: L2C0038TR IC: 3432A-0038TR

This device complies with Part 15 of the FCC Rules
and with Industry Canada license-exempt RSS
standard(s). Operation is subject to the following
two conditions: (1) This device may not cause
harmful interference, and (2) This device must
accept any interference received, including
interference that may cause undesired operation.

Le présent appareil est conforme aux CNR
d'industrie Canada applicables aux appareils
radio exempts de licence. L'exploitation est
autorisée aux deux conditions suivantes: (1)
l'appareil ne doit pas produire de brouillage, et
(2) l'utilisateur de l'appareil doit accepter tout
brouillage radioélectrique subi, même si le
brouillage est susceptible d'en compromettre le
fonctionnement.

Note: Changes or modifications not expressly
approved by the party responsible for compliance
could void the user's authority to operate the
equipment. The term "IC:" before the radio
certification number only signifies that Industry
Canada technical specifications were met.

Note: This equipment complies with radiation
exposure limits set forth for an uncontrolled
environment. This equipment should be installed
and operated with minimum distance of 20 cm
between the radiator and your body.

REACH

Registration, Evaluation, Authorisation and Restriction of Chemicals (REACH) is a European Union regulation adopted to improve the protection of human health and the environment from the risks that can be posed by chemicals. Visit www.opel.com/reach for further information and for access to the Article 33 communication.

Registered trademarks

Apple Inc.

Apple CarPlay™ is a trademark of Apple Inc.

App Store® and iTunes Store® are registered trademarks of Apple Inc.

iPhone®, iPod®, iPod touch®, iPod nano®, iPad® and Siri® are registered trademarks of Apple Inc.

Bluetooth SIG, Inc.

Bluetooth® is a registered trademark of Bluetooth SIG, Inc.

DivX, LLC

DivX® and DivX Certified® are registered trademarks of DivX, LLC.

EnGIS Technologies, Inc.

BringGo® is a registered trademark of EnGIS Technologies, Inc.

Google Inc.

Android™ and Google Play™ Store are trademarks of Google Inc.

Stitcher Inc.

Stitcher™ is a trademark of Stitcher, Inc.

Verband der Automobilindustrie e.V.

AdBlue® is a registered trademark of the VDA.

Vehicle data recording and privacy

Event data recorders

Electronic control units are installed in your vehicle. Control units process data which is received by vehicle sensors, for example, or which they generate themselves or exchange amongst themselves. Some control units are necessary for the safe functioning of your vehicle, others assist you while you drive (driver assistance systems), while others provide comfort or infotainment functions.

The following contains general information about data processing in the vehicle. You will find additional information as to which specific data is uploaded, stored and passed on to third parties and for what purpose in your vehicle under the key word Data Protection closely linked to the references for the affected functional characteristics in the relevant owner's manual or in the general terms of sale. These are also available online.

Operating data in the vehicle

Control units process data for operation of the vehicle.

This data includes, e.g.:

- vehicle status information (e.g. speed, movement delay, lateral acceleration, wheel rotation rate, "seat belts fastened" display)
- ambient conditions (e.g. temperature, rain sensor, distance sensor)

As a rule such data is transient, not stored for longer than an operational cycle, and only processed on board the vehicle itself. Control units often include data storage (including the vehicle key). This is used to allow information to be documented temporarily or permanently on vehicle condition, component stress, maintenance requirements and technical events and errors.

Depending on technical equipment level, the data stored is as follows:

- system component operating states (e.g. fill level, tyre pressure, battery status)
- faults and defects in important system components (e.g. lights, brakes)
- system reactions in special driving situations (e.g. triggering of an airbag, actuation of the stability control systems)
- information on events damaging the vehicle
- for electric vehicles the amount of charge in the high-voltage battery, estimated range

In special cases (e.g. if the vehicle has detected a malfunction), it may be necessary to save data that would otherwise just be volatile.

When you use services (e.g. repairs, maintenance), the operating data saved can be read together with the vehicle identification number and used when necessary. Staff working for the service network (e.g. garages, manufacturers) or third parties (e.g.

breakdown services) can read the data from the vehicle. The same applies to warranty work and quality assurance measures.

Data is generally read via the OBD (On-Board Diagnostics) port prescribed by law in the vehicle. The operating data which is read out, documents the technical condition of the vehicle or individual components and assists with fault diagnosis, compliance with warranty obligations and quality improvement. This data, in particular information on component stress, technical events, operator errors and other faults, is transmitted to the manufacturer where appropriate, together with the vehicle identification number. The manufacturer is also subject to product liability. The manufacturer potentially also uses operating data from vehicles for product recalls. This data can also be used to check customer warranty and guarantee claims.

Fault memories in the vehicle can be reset by a service company when carrying out servicing or repairs or at your request.

Comfort and infotainment functions

Comfort settings and custom settings can be stored in the vehicle and changed or reset at any time.

Depending on the equipment level in question, these include

- seat and steering wheel position settings
- chassis and air conditioning settings
- custom settings such as interior lighting

You can input your own data in the infotainment functions for your vehicle as part of the selected features.

Depending on the equipment level in question, these include

- multimedia data such as music, videos or photos for playback in an integrated multimedia system
- address book data for use with an integrated hands-free system or an integrated navigation system

- input destinations
- data on the use of online services

This data for comfort and infotainment functions can be stored locally in the vehicle or be kept on a device that you have connected to the vehicle (e.g. a smartphone, USB stick or MP3 player). Data that you have input yourself can be deleted at any time.

This data can only be transmitted out of the vehicle at your request, particularly when using online services in accordance with the settings selected by you.

Smartphone integration, e.g. Android Auto or Apple CarPlay

If your vehicle is equipped accordingly, you can connect your smartphone or another mobile device to the vehicle so that you can control it via the controls integrated in the vehicle. The smartphone image and sound can be output via the multimedia system in this case. At the same time, specific information is transmitted to your smartphone. Depending on the type of integration,

this includes data such as position data, day / night mode and other general vehicle information. For more information, please see the operating instructions for the vehicle / infotainment system.

Integration allows selected smartphone apps to be used, such as navigation or music playback. No further integration is possible between smartphone and vehicle, in particular active access to vehicle data. The nature of further data processing is determined by the provider of the app used. Whether you can define settings, and if so which ones, is dependent on the app in question and your smartphone's operating system.

Online services

If your vehicle has a radio network connection, this allows data to be exchanged between your vehicle and other systems. The radio network connection is made possible by means of a transmitter device in your vehicle or a mobile device provided by you (e.g. a smartphone). Online functions can be used via this radio network connection. These include online services and applications / apps provided to you by the manufacturer or other providers.

Proprietary services

In the case of the manufacturer's online services, the relevant functions are described by the manufacturer in an appropriate location (e.g. Owner's Manual, the manufacturer's website) and the associated data protection information is provided. Personal data may be used to provide online services. Data exchange for this purpose takes place via a protected connection, e.g. using the manufacturer's IT systems provided for the purpose. Collection,

processing and use of personal data for the purposes of preparation of services take place solely on the basis of legal permission, e.g. in the case of a legally prescribed emergency communication system or a contractual agreement, or by virtue of consent.

You can activate or deactivate the services and functions (which are subject to charges to some extent) and, in some cases, the vehicle's entire radio network connection. This does not include statutory functions and services such as an emergency communication system.

Third party services

If you make use of online services from other providers (third parties), these services are subject to the liability and data protection and usage conditions of the provider in question. The manufacturer frequently has no influence over the content exchanged in this regard.

Therefore, please note the nature, scope and purpose of the collection and use of personal data within the scope of third party services provided by the service provider in question.

Radio Frequency Identification (RFID)

RFID technology is used in some vehicles for functions such as tyre pressure monitoring and immobiliser. It is also used in connection with conveniences such as radio remote controls for door locking / unlocking and starting. RFID technology in Vauxhall vehicles does not use or record personal information or link with any other Vauxhall system containing personal information.

Body conversions

Tipper and dropside	325
Loading information	325
Tailboard	326
Sideboards	327
Lashing eyes	328
Tipper operation	328
Safety prop	330
Hydraulic oil level	331
Toolbox	332
Exterior lighting	332
Cleaning	332
Vehicle checks	332
Technical data	333
Declaration of conformity	333
Box body	334
Keys	334
Doors	334
Roller shutter	335
Step	335
Ladder	336
Overcab storage	336
Load rails	336
Interior lighting	337

Crew van	337
Child restraint systems	337
Storage	337

Tipper and dropside

Loading information

The tipper and dropside are not designed for carrying people or unsuitable / unsafe materials.

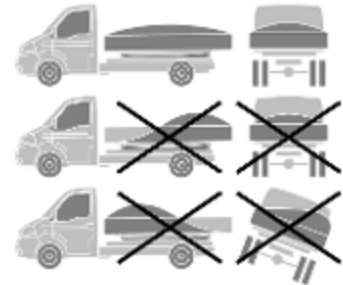

- Load the vehicle evenly, distributing the load across the body.
- Ensure the vehicle tailboard and sideboards are securely closed before loading.
- Secure any solid loads with additional lashing equipment.

- Place loads from the minimum practicable height. Do not drop loads onto the body.
- Do not overload the body.
- Ensure the load will not fall out or endanger other road users.
- Do not drive with the body tipped.
- Do not drive with the tailboard or sideboards down.
- Do not attempt to tip loads from the body when body sides or tailboard are closed.
- Observe the safety warning labels placed on the tipper and dropside bodies.
- Do not attempt to tip loads unless the vehicle is on solid ground.
- The isolation switch must be in the **OFF** position when tipping function is not in use.

Caution

Do not exceed the maximum lateral load of 200 kg (dropside body) and 400 kg (tipper body) as stated on the head board.

When loading heavy or bulk items, the lashing eyes must be flush with the body floor to avoid causing any damage.

Refer to the safety warning labels located on the tipper or dropside body.

The maximum loading on the dropside body floor is 230 kg per 80 mm x 80 mm or 80 kg per 50 mm x 50 mm.

Tailboard

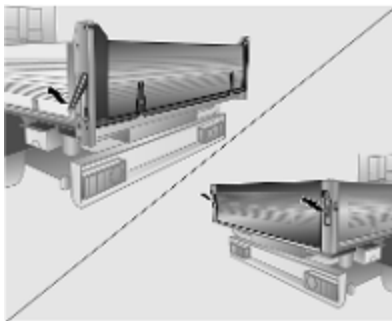

Opening

Pull up the release levers to disengage the locks and lower the tailboard fully.

Step

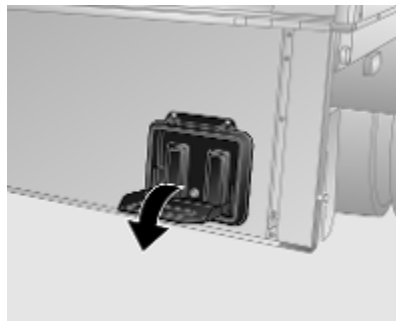

With the tailboard lowered, fold down the step. Fold up when not required.

Closing

Raise the tailboard and push firmly into position. Push down the release levers ensuring locks engage fully.

Swinging

The tailboard lower hinges can be released to allow the tailboard to swing from its upper hinges during tipping operations.

⚠ Warning

To prevent the tailboard becoming detached from the vehicle, ensure that the upper hinges are engaged with the release levers in the locked position.

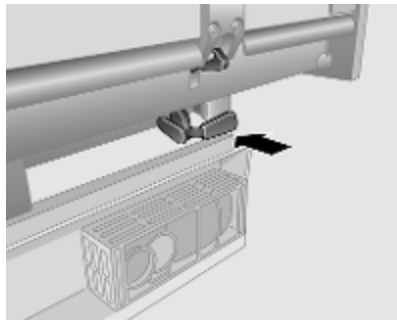

Release the lower hinges using the remote lever located at the rear of the body. The tailboard is disengaged and will swing from its upper hinges.

To lock, engage the lower tailboard hinges and push the remote lever to the lock position. Check the tailboard is secure.

Sideboards

⚠ Warning

The sideboards are heavy.

Take care when lowering the sideboards, do not allow them to drop down unassisted.

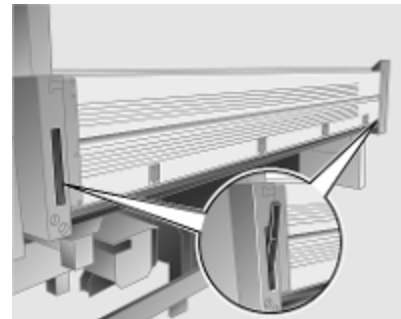

To open, pull up the release levers to disengage the locks. Lower the sideboard fully.

To close, raise the sideboard and push firmly into position. Push down the release levers ensuring locks engage fully.

Lashing eyes

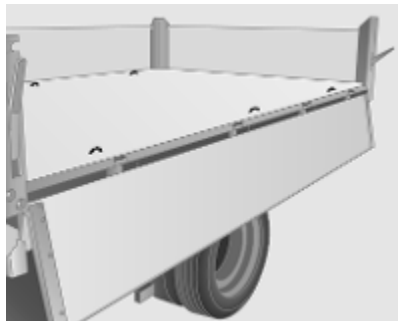

Secure heavy objects with lashing straps attached to the lashing eyes.

Caution

The maximum force applied to the lashing eyes should not exceed 4000 N or 8000 N at 30°.

Refer to the safety warning labels located on the tipper or dropside body.

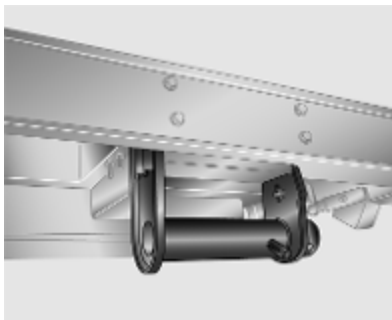

Additional cargo strap retainers are located under the tipper body floor.

Tipper operation

⚠ Warning

Before operating the tipper, apply the parking brake and select neutral gear position.

The operator must remain at the control to ensure tipping and lowering are performed correctly.

Keep other people away when tipping function is in use.

Ensure the vehicle is on solid ground and that the tipper body can be raised to the maximum height without touching overhead obstructions.

The tipper body has two locking pins which must be always attached while operating. The locking pins are used to obtain any one of the three tipping positions.

Caution

The tipper must not be operated with locking pins incorrectly installed.

Pins installed diagonally opposite or in both front pivot positions will result in damage if tipping is attempted.

Tipping to the side

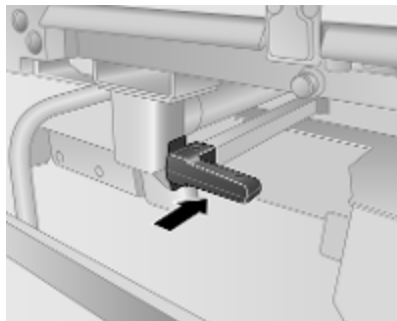

Push lever to access the front pivot.

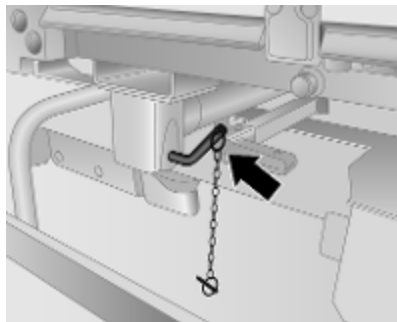

Insert locking pins into the front and rear pivots on the same side. Ensure the handle and locator on both locking pins are facing up.

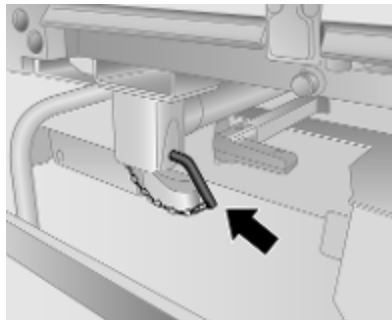

Rotate both locking pins away from the upright position and secure each locking chain. Lower the sideboard fully.

Tipping to the rear

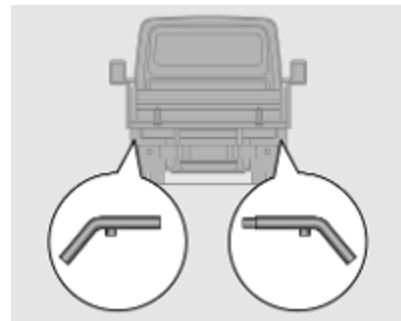

⚠ Warning

To prevent the tailboard becoming detached from the vehicle, ensure that the upper hinges are engaged and push the release levers downwards to engage the locks fully.

Insert locking pins into the left and right rear pivots. Ensure the handle and locator on both locking pins are facing up. Rotate both locking pins away from the upright position and secure each locking chain.

Isolation switch

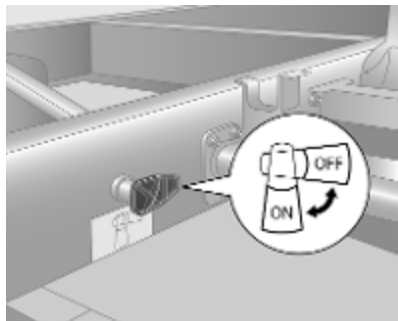

The system must be activated using the isolation switch located on the left-hand side of the chassis. Turn the isolator switch to the **ON** position.

When the tipper is not in use, turn the isolation switch to the **OFF** position.

Raising and lowering the tipper

The tipper is operated using the remote control located by the front seats.

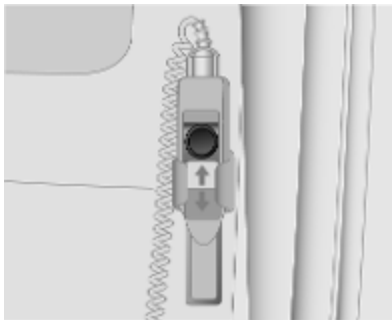

The remote control enables the user to supervise the operation of the tipper from outside the vehicle.

Press switch:

- ↑ : raise
- ↓ : lower

When the tipper is active an acoustic signal sounds.

The tipper can be stopped at any time by releasing the switch.

The tipper body will cease moving automatically when it reaches the maximum height.

To stop in an emergency, press the red button.

Store the remote control in the holder when not in use.

Safety cable

The safety cable attached to the tipper body prevents the tipper body being raised too far. Should the safety cable become damaged it must be replaced immediately. Seek the assistance of a workshop.

Safety prop

The safety prop is located under the left-hand side of the tipper body and is provided only to assist in supporting the empty tipper body when tipped to the rear, for carrying out visual inspection of the vehicle components.

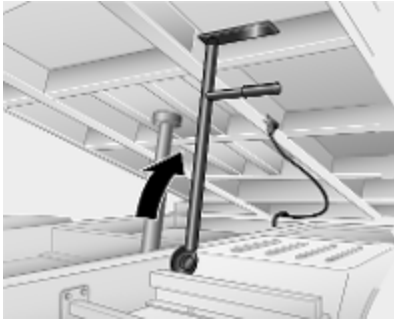

Using the safety prop

1. Prepare the tipper body for tipping to the rear.
2. Raise the tipper fully.
3. Raise the safety prop to align with support on the tipper.
4. Lower the tipper body until the safety prop is in contact with the tipper.

Stowing the safety prop:

1. Raise the tipper body sufficiently to release the safety prop from its support.
2. Lower the safety prop into the stowed position.
3. Lower the tipper body.

Hydraulic oil level

Caution

Before any inspection work can be carried out the safety prop must be in position.

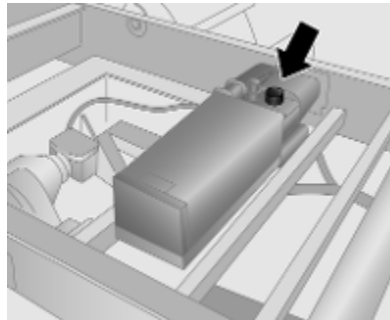

With the tipper fully raised, the hydraulic oil level must be between the **MIN** and **MAX** marks.

Caution

Only use products that have been tested and approved. Damage resulting from the use of nonapproved materials will not be covered by the warranty.

The use of additives could cause damage and invalidate the warranty.

Check the hydraulic oil level after long driving on bumpy or steep roads.

Have the cause of the loss of hydraulic oil remedied by a workshop.

Use only hydraulic oil type SAE 10 (ISO 32), or a type Q8 ELI 1298L suitable for Class 1 conditions.

Toolbox

Unlock using the key provided and turn latches to open.

Close the door and turn both latches, then lock with the key.

Caution

Ensure the toolbox door is properly secure before setting off.

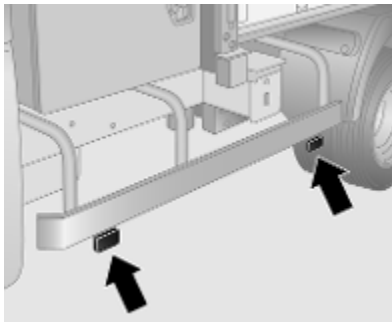
Exterior lighting

Additional exterior lights illuminate in combination with the side lights.

Have bulbs replaced by a workshop.

Cleaning

Dirt or mud which remains dry on the body may become abrasive and can damage paint, seals, locks and hinges.

Clean the following parts if they become contaminated with dirt:

- Sideboard and tailboard locking latches and hinges.
- Tipper body pivot pins and locating holes.

Caution

Do not spray high-pressure water directly at the hydraulic seals, pump, reservoir, hydraulic ram ball joints, or guide clamps.

After cleaning, check, and if necessary lubricate the components listed in the owner's checks.

Warning

Do not venture under the tipper body when raised.

Vehicle checks

Check regularly the following items:

- Visually check the subframe mountings, the safety cables and the hydraulic system. If any of the

components appear loose, defective or leaking, seek the assistance of a workshop to rectify the cause of the fault.

- The tipper has an operating angle of 45° - 50°. If this limit is exceeded, seek the assistance of a workshop to rectify the cause of the fault.
- Do not operate the tipper if the acoustic signal doesn't sound. Seek the assistance of a workshop.
- Lubricate every six months the tipper body pivots with high-pressure grease.
- Check every 50 work hours or 6 months, whichever occurs first, the hydraulic oil level in the reservoir.

Technical data

The technical data is determined in accordance with European Community standards.

We reserve the right to make modifications. Specifications in the vehicle documents always have priority over those stated here.

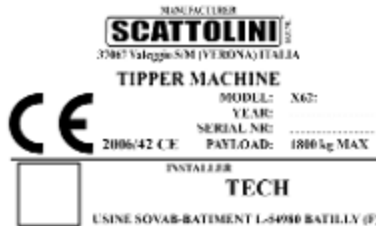

Additional information can be found on the body data plate.

Declaration of conformity

The declaration of conformity which meets directive 2006/42/CE is provided with the vehicle.

SCATTOLINI		CE
<small>VIA DELL'AVOMO, 8 37067 VALLEGGIO S.M. MENCIO (VERONA) ITALY TEL. +39 045 8640011 FAX +39 045 8640009 E-MAIL INFO@SCATTOLINI.COM</small>		<small>2006/42</small>
COMPLIANCE DOCUMENT DIR. 2006/42 CE		
<small>DECLARE:</small>		
VEHICLE TYPE:		
<input type="checkbox"/> E2 P2 DC RL	DOUBLE CABINE PROPULSION L3 BOUS-JUNELLEES	dir. 2006/1100
<input type="checkbox"/> E2 P1 DC RL	DOUBLE CABINE TRACTPROP L3 BOUS SIMPLES	dir. 2006/1100
<input type="checkbox"/> E2 P1 CS RL	CHASSIS CABINE PROPULSION L3 BOUS 25 SHELLES	dir. 2006/1100+CE03
<input type="checkbox"/> E2 P1 CS RL	CHASSIS CABINE TRACTPROP L3 BOUS SIMPLES	dir. 2006/1100
<input type="checkbox"/> E2 P1 CS RL	SHORTENED CHASSIS CABINE PROP. L3 BOUS 25 SHELLES	dir. 2006/1100
TIPPER MODEL:		
<input type="checkbox"/> REAR TIPPER ALL		
<input type="checkbox"/> REAR TIPPER VIEL		
<input type="checkbox"/> THREE WAY ALL		
<input type="checkbox"/> THREE WAY VIEL		
VEHICLE TYPE:		MOVANO X41
SERIAL NUMBER TIPPER:		
EX330MM:		"TXX1200KJ"
REGIIE TIPPER:		CAROT F 100 SE
<small>COMPANY SCATTOLINI S.P.A. DECLARES UNDER ITS OWN RESPONSIBILITY THAT THE EQUIPMENT FOR THE ABOVE MENTIONED VEHICLE COMPLES WITH CE/EEC REGULATIONS 2006/42 (MACHINE DIRECTIVE) AND 2006/20 (EMC) CE, ELECTROMAGNETIC COMPATIBILITY, AND ALSO WITH STANDARD ENI 1099, 1099C, 1099D, 1099E AND 1099F ON TIPPING EQUIPMENTS. STARTING UCLAGE IS FORBIDDEN IF:</small>		
<small>- MOUNTING OF THE EQUIPMENT IS NOT PERFORMED PROPERLY AND IN COMPLIANCE WITH THE STANDARDS AND MOUNTING DIRECTIONS FROM THE MANUFACTURER;</small>		
<small>- TESTS PERFORMED AFTER MOUNTING HAVE NOT BEEN SUCCESSFUL;</small>		
<small>- THE MOUNTING DECLARATION HAS NOT BEEN ISSUED.</small>		
		FATHELLY
VALLEGGIO S.M. MENCIO I.L.		MAVR MACRIZIO
INSTALLER		DECLARATION
TECH		CE
<small>USINE SOVAB-BATIMENT L-54980 BATTILY (F)</small>		<small>2006/42</small>
DECLARES THEY HAVE INSTALLED THE ABOVE DESCRIBED EQUIPMENT		
CHASSIS NUMBER VIN : _____		
AND THAT:		
MOUNTING OF THE EQUIPMENT IS PERFORMED PROPERLY AND IN COMPLIANCE WITH THE STANDARDS AND MOUNTING DIRECTIONS FROM THE MANUFACTURER.		
<small>- TESTS PERFORMED AFTER MOUNTING HAVE BEEN SUCCESSFUL.</small>		
BATILY: _____		FATHELLY

Box body

Keys

The radio remote control only operates the front door locks.

Additional keys are provided for the load compartment door locks.

Doors

Side door

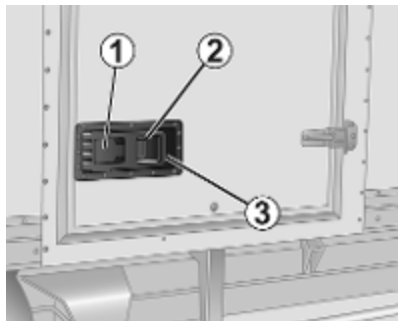

Unlock by turning the key under cover (1) in the side door lock. Press button (2) and fully extend door handle (3). Pull the door handle to open door.

When closing, with the door handle fully extended; push the door shut.

Push the handle back into the recess and lock with the key to secure.

Rear doors

Opening

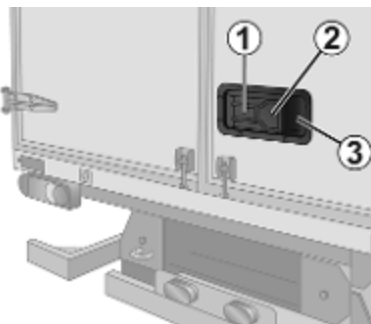

Unlock by turning the key under cover (1) in the rear door lock. Press button (2) and fully extend door handle (3). Pull the door handle to open door.

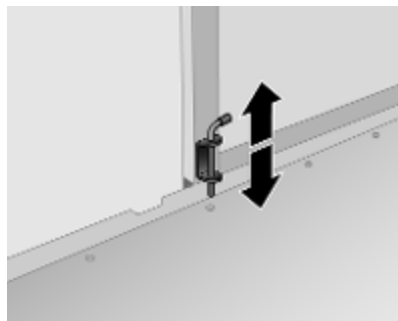

The left-hand rear door is opened by lifting the interior catch.

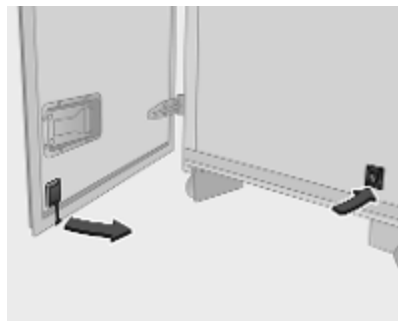

When opening the doors to 270°, the doors are retained in the fully open position by securing the catches on the body side.

Closing

Release the catches from the body side and always close the left-hand rear door first.

When closing, with the door handle fully extended; push the door shut.

Push the handle back into the recess and lock with the key to secure.

Roller shutter

Opening

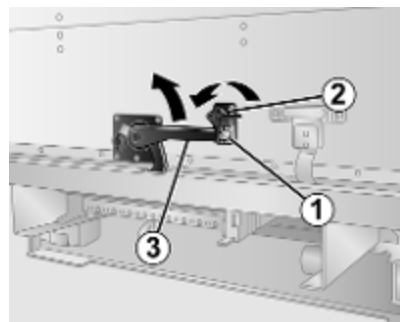

Unlock by turning the key in the rear door lock (1).

Turn latch (2) to release lever.

Lift lever (3) fully until the safety catch is engaged.

Closing

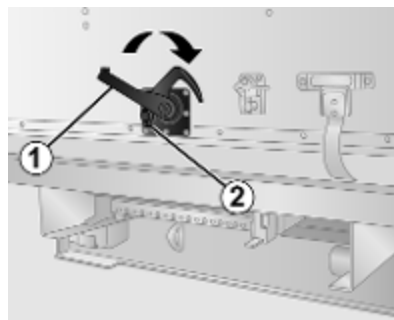

Pull the roller shutter down using the strap. Release catch (2) and lift lever (1) until it engages. Turn latch to secure lever and lock using the key.

Step

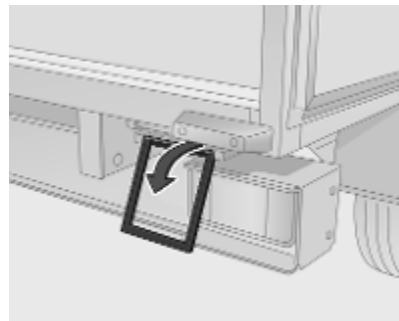

To lower the step, pull the step out from beneath the vehicle body and swing it down.

To stow the step, swing up into the horizontal position and push into the recess under the vehicle body.

Ladder

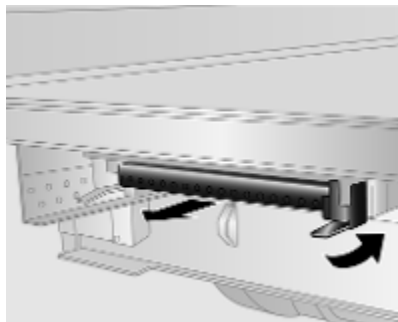

To lower the ladder, push down latch to release and pull the ladder out.



Unfold the ladder and attach the bottom step into position. Ensure the latch engages and the steps are secure before climbing.

Warning

The ladder must be stowed securely before driving.

Overcab storage

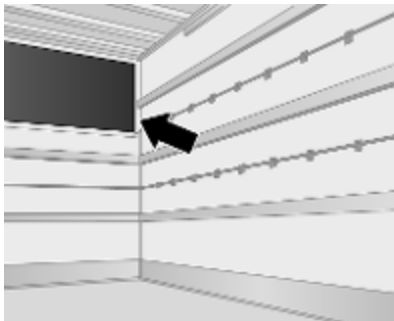

The total weight in this compartment must not exceed 80 kg.

Load rails

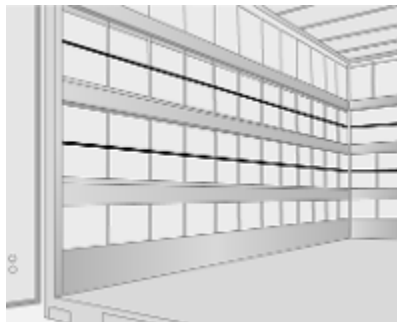

Load anchorage rails mounted in the load compartment provide anchorage points for securing cargo.

The maximum load on each rail is 2500 N.

Interior lighting



Press switch: light will operate for approx. 10 minutes.

Bulb replacement



1. Release screws using a suitable screwdriver and remove lens.
2. Remove and replace bulb.
3. Refit lens and secure screws.

Crew van

Child restraint systems

⚠ Warning

Child restraint systems must not be installed to any position on the rear passenger seat.

Child restraint systems ⇨ 64.

Storage

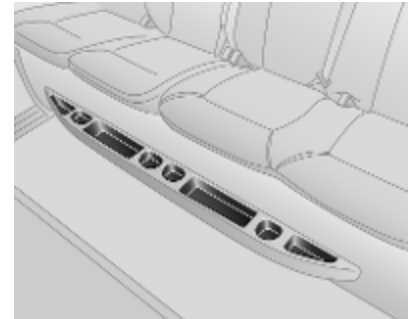

Storage compartments, pockets and nets are located in the rear passenger compartment.

Underseat storage



To gain access to the storage compartment under the seat, pull the front of the seat cushion up and forward.



Do not place heavy items in the storage area.

⚠ Warning

Ensure the seat cushion is returned to the rest position before occupying seat.

Storage nets

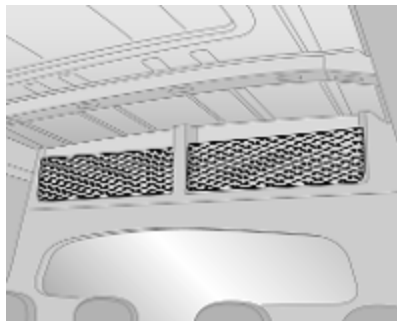

⚠ Warning

Do not place heavy or pointed objects in the storage nets.

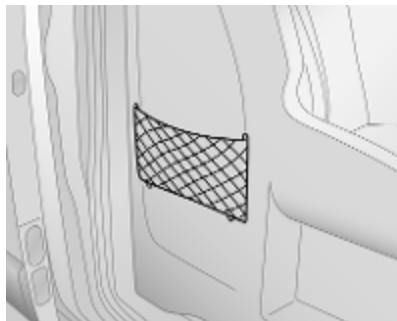

An additional storage net is located on the seat base.

Load compartment storage

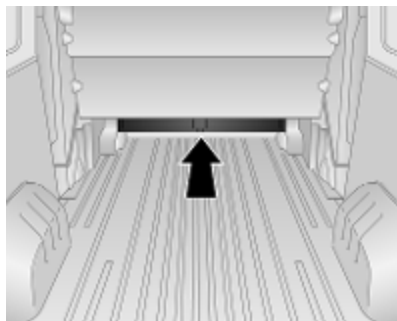

Items can be stowed in the recess beneath the rear bulkhead.

Tie rods



Warning

Do not secure cargo using the tie rods in the load compartment.

Index

A

Absorptive Glass Mat battery..... 273
 Accessories and vehicle
 modifications 268
 ACC files..... 152
 Activating Bluetooth function..... 196
 Activating the navigation system 165
 Activating voice recognition..... 191
 Active emergency braking. . 103, 252
 Adaptation volume km/h..... 137
 AdBlue..... 100, 233, 311
 AdBlue gauge..... 92
 AdBlue tank..... 315
 Add a favourite destination..... 176
 Adding contacts to the
 phonebook..... 200
 Adjustable air vents 220
 AF (Alternative Frequency)..... 147
 Airbag and belt tensioners 97
 Airbag deactivation 62, 97
 Airbag label..... 58
 Airbag system 58
 Air conditioning regular
 operation 222
 Air conditioning system 208
 Air intake 222
 Air suspension 230
 Air suspension system..... 305
 Air vents..... 220
 Antifreeze..... 272

Antilock brake system 243
 Antilock brake system (ABS) 99
 Anti-theft alarm system 35
 Anti-theft bolts..... 298
 Anti-theft locking system 34
 Anti-theft security lock..... 22
 Appearance care..... 307
 Armrest 50
 Ashtrays 90
 AST (Autostore list)..... 146
 Audio players..... 128
 Audio settings..... 136
 Automatic call waiting..... 200
 Automatic light control 109
 Automatic locking..... 23, 28
 Automatic phone connection..... 194
 Automatic station search..... 144
 Automatic station storing..... 146
 Automatic switch-off..... 128
 Automatic zoom..... 165
 Autostop..... 17, 226, 227
 Autostore lists..... 146
 Auxiliary heater..... 215
 AUX input..... 150
 AUX input usage..... 151
 Avoid part of route..... 182

B

Balance..... 136
 Bass..... 136

Battery..... 20, 21, 215, 273
 Battery discharge protection 116
 Battery, jump starting..... 303
 Battery replacement..... 165
 Belts..... 54
 Bluetooth..... 192
 Bluetooth connection..... 155, 196
 Bluetooth device list..... 196
 Bluetooth music..... 155
 Bonnet 269
 Bottle holders..... 73
 Brake assist 245
 Brake fluid 273, 311
 Brakes 243, 273
 Brake system 99
 Breakdown..... 305
 Browse map..... 182
 Bulb replacement 276
 Bus
 Rear seats..... 51

C

Cabin bulkhead grille..... 79
 Call lists..... 200
 Call waiting..... 200
 Capacities 315
 Cargo management system 77
 Car Pass 20
 Catalytic converter 233
 Central locking system 23

Centre high-mounted brake light 281
 Change Home location..... 165
 Change passkey for Bluetooth
 connection..... 196
 Change system language... 128, 138
 Changing tyre and wheel size ... 294
 Charging system 98
 Child locks 29
 Child restraint installation
 locations 66
 Child restraints..... 64
 Child restraint systems 64, 337
 Cigarette lighter 90
 Cleaning..... 332
 Cleaning the vehicle..... 307
 Climate control 15
 Climate control systems..... 207
 Clock 87, 128, 138, 165
 Coat hooks..... 73
 Compass..... 165
 Connecting an audio device..... 155
 Connection..... 194
 Control elements overview..... 121
 Control indicators..... 94
 Control of the vehicle 224
 Controls..... 84
 Convex shape 38
 Coolant..... 272
 Coolant and antifreeze..... 311
 Coolant heater..... 215

Co-ordinates..... 165, 176
 Country information..... 182, 199
 Cruise control 102, 248
 Cupholders 73

D

DAB..... 150
 Danger, Warnings and Cautions ... 4
 Dashboard..... 11
 Data sharing settings..... 128
 Daytime running lights 112
 Daytime running lights setting... 128
 Deactivating Bluetooth function.. 196
 Deactivating guidance..... 182
 Declaration of conformity.... 317, 333
 DEF..... 233
 Defining the priority phone..... 194
 Delete a favourite destination.... 176
 Delete device from Bluetooth
 device list..... 196
 Demisting and defrosting..... 15
 Destination..... 165
 Destination input 176
 Dialling a telephone number..... 200
 Diesel exhaust fluid..... 233
 Diesel fuel..... 261
 Diesel fuel system bleeding 275
 Diesel particle filter 232
 Digital audio broadcasting..... 150
 Disconnecting an audio device... 155

Disconnecting a phone.....	194
Display.....	128
Displaying pictures.....	160
Display screen operation....	128, 192
Door locks.....	22
Door open	103
Doors.....	29, 334
DPF (diesel particle filter).....	232
Drink holders.....	73
Driver assistance systems.....	248
Driver Information Centre.....	104
Driving characteristics and towing tips	264
Driving economically.....	224
Driving hints.....	224
Driving style indicator Fuel economy gauge.....	128
E	
Easy access.....	128
Eco-coaching.....	128
Eco Driving.....	128
ECO mode.....	224
Edit Itinerary.....	182
Electric adjustment	38
Electrical accessories.....	87
Electrical system.....	284
Electronic climate control system	209
Electronic driving programmes ..	242
Electronic key system.....	21

Electronic Stability Control	100, 247, 265
Emergency call.....	199
Emergency exit.....	41, 43
Emergency number.....	199
End-of-life vehicle recovery	269
Engine compartment fuse box ..	285
Engine coolant	272
Engine coolant temperature	100
Engine coolant temperature gauge	92
Engine drag torque control.....	247
Engine exhaust	232
Engine identification.....	314
Engine oil	270, 311, 315
Engine oil additives.....	311
Engine oil pressure	101
Engine oil viscosity grades.....	311
Enhanced traction function	246, 247, 248
Enter an address.....	176
Entering a number manually.....	200
Event data recorders.....	321
Exhaust gases.....	232
Exit lighting	115
Exterior care	307
Exterior light	102
Exterior lighting	13, 109, 332
Exterior mirrors.....	38
External device authorisation....	196

F	
Fader.....	136
Fault	243
Favourite destinations.....	176
Favourites.....	128
Media.....	128
Navigation.....	128
Phone.....	128
Services.....	128
Fire extinguisher.....	80
First aid.....	80
First aid kit	80
Fixed air vents	221
FM station list.....	146
Fog lights.....	112
Folding mirrors	38
Folding mirrors setting.....	128
Folding seat.....	73
Front airbag system	61
Front courtesy light.....	113
Front fog lights	102, 112, 278
Front reading light.....	115
Front seats.....	45
Front storage.....	73
Front turn lights	278
Fuel economy gauge Driving style indicator.....	128
Fuel for diesel engines	261
Fuel gauge	92
Fuel tank.....	315

Functions during a telephone call 200
 Fuse box..... 285, 286, 287
 Fuses 284

G

Gauges..... 90
 Gear shifting..... 99
 General information... 117, 150,
 152, 155, 163, 190, 192, 264
 Glass panel 43
 Glovebox 73
 Glovebox cooler 221
 GPS (Global Positioning System) 163
 Grab handles..... 75
 Ground clearance..... 230
 Guidance 182

H

Hand brake - see Parking brake. 244
 Handsfree phone system..... 200
 Hazard warning flashers 112
 HD Traffic..... 165
 Headlight flash 111
 Headlight range adjustment 111
 Headlights..... 109, 110, 277
 Headlights when driving abroad 111
 Head restraint adjustment 8
 Head restraints 44
 Heated exterior mirrors..... 15
 Heated mirrors 39
 Heated rear window..... 15, 42

Heating 51
 Heating and ventilation system . 207
 Help!..... 182, 190
 High beam 102, 110
 High beam assist..... 102, 110
 Hill start assist 245
 Home address..... 176
 Home location..... 165
 Horn 14, 84
 Hub cap hook..... 289
 Hydraulic oil level..... 331

I

i-Announcement..... 147
 Identification plate 314
 Idle speed control..... 227
 Ignition switch positions 225
 Image settings..... 128
 Image viewer..... 165
 Immobiliser 37
 Indicators..... 90
 Inductive charging..... 89
 i-News service..... 147
 Info Display..... 104
 Information displays..... 104
 Information on the display. . 135, 165
 Infotainment controls..... 128
 Infotainment system..... 104
 Switching on/off..... 128
 Initial drive information..... 6

Instrument cluster 90
 Instrument panel controls..... 121
 Instrument panel fuse box 286
 Instrument panel illumination 284
 Instrument panel overview 11
 Instrument panel storage..... 72
 Interior care 309
 Interior lighting..... 113, 337
 Interior lights 113, 283
 Interior mirrors..... 39
 Interruption of power supply 243
 Intersection view..... 165
 Introduction 3
 iPod..... 152, 153
 ISOFIX..... 64
 Isolation switch..... 328
 i-Traffic service..... 147

J

Jack..... 289
 Jack plug..... 151
 Journey record..... 104
 Jump starting 303

K

Keyboards in the display.... 165, 192
 Keys 19, 334
 Keys, locks..... 19

L

Ladder.....	336
Lane departure warning.....	100, 260
Lane images.....	165
Language.....	128
Lashing eyes	76, 328
Lashing straps.....	76
Latitude, Longitude.....	176
Laying up the vehicle.....	273
Light covers, misted.....	113
Lighting.....	109
Lighting features.....	115
Light switch	109
Limited-slip rear axle.....	248
Limited speed.....	103
Live services.....	165
Load compartment.....	23, 75
Load compartment fuse box	287
Load compartment grille.....	79
Load compartment lighting.....	114
Loading information	81, 325
Load rails.....	336
Local search.....	176
Loudness.....	136
Low beam.....	102
Low fuel	102
Low volume sound enhancement	136
Luggage floor net.....	76

M

Mailbox.....	200
Malfunction indicator light	98
Manual adjustment	38
Manual anti-dazzle	39
Manual door locks.....	23
Manual mode	242
Manual phone connection.....	194
Manual station search.....	144
Manual station storing.....	146
Manual transmission.....	16, 240
Manual transmission	
automated.....	16, 240
Manual windows	41
Maps.....	163
Map screen.....	165
Menu screen.....	135, 165
Messages.....	105
Mirror adjustment	9
Mirrors.....	38, 39
Misted light covers	113
Mobile phones and CB radio	
equipment	206
Modes of operation.....	128
Motorway view.....	165
MP3 files.....	152
MP3 player.....	153
MP3 players.....	152
Multimedia.....	160, 161
Multimedia settings.....	138

Musical atmosphere.....	136
Mute.....	128
My TomTom LIVE.....	165

N

Navigation control.....	191
Navigation services.....	128
Navigation system	
Creating an account.....	163
GPS (Global Positioning	
System).....	163
Installing the software.....	163
Maps.....	163
Registering the Navigation	
system.....	163
SD card.....	163
Software installation.....	163
Traffic info service.....	163
USB memory stick.....	163
Navigation system preferences..	165
Navigation volume.....	165
Navigation warnings.....	165
News.....	147
New vehicle running-in	225
Number plate light	282

O

Object detection systems.....	254
Odometer	91
Oil.....	270
Oil, engine.....	311, 315

Oil pressure.....	101
Onboard computer.....	128
Operation.....	155, 200
Outside temperature	86
Overcab storage	75, 336
Overhead console	74
Overrun cut-off	227

P

Pairing a mobile phone.....	196
Pairing an audio device.....	155
Park Assist.....	128
Parking	18, 230
Parking assist	254
Parking brake.....	99, 244
Parking distance control.....	254
Parking ticket holder.....	43
Particulate filter.....	232
Pedals.....	224
Performing work	269
Phone.....	192
Phonebook.....	200
Phone connection.....	194
Phone control.....	192
Phone controls.....	192
Phone installation instructions....	206
Phone menu.....	200
Phone operating guidelines.....	206
Phone projection.....	162
Phone settings.....	200

Photos.....	160
Pictures.....	160
Planning preferences.....	165
Playing movies.....	161
Playing music via Bluetooth.....	155
Playing saved audio files.....	153
POI categories.....	176
Points of interest.....	128
Points of Interest (POI).....	176
POIs.....	128, 176
Portable CD players.....	151
Power door locks.....	28
Power outlets	87
Power side step.....	29
Power sliding door.....	29
Power steering fluid.....	272
Power take-off.....	265
Power windows	41
Preheating	100, 226
Prepare route in advance.....	176
PTY (Program type).....	147
Puncture.....	295, 298

Q

Quick menu.....	165
-----------------	-----

R

Radio.....	143
DAB.....	150
Digital Audio Broadcasting.....	150
Radio controls.....	143

Radio data system (RDS)	147
Radio Frequency Identification (RFID).....	324
Radio functions.....	146, 147
Radio reception.....	143
Radio remote control	20
Radio station name search.....	144
Radio text.....	147
Rain sensor.....	85
RDS.....	147
REACH.....	321
Reading lights	115
Rear air conditioning system	214
Rear bench seat storage.....	74
Rear camera.....	128
Rear camera view settings.....	128
Rear courtesy light.....	113
Rear doors	33
Rear fog light	102, 113, 279
Rear heating system	212
Rear OFF.....	136
Rear reading light.....	115
Rear reversing lens.....	41
Rear seats	51
Bus.....	51
Installing.....	51
Rear seat access.....	51
Removing.....	51
Rear storage.....	75
Rear view camera	258

Rear view display.....	40
Rear windows	41
Rear window wiper setting.....	128
Recalling a station.....	146
Recalling a stored station.....	144
Receiving calls.....	200
Recent destinations.....	176
Recommended fluids and lubricants	311, 315
Refuelling	262
Region.....	147
Registered trademarks.....	321
Remote control.....	20
Restore default settings.....	128
Restore factory settings.....	138
Retractable parking brake.....	244
Reversing lights	113
Ride control systems.....	246, 248
Ride height.....	230
Roller shutter.....	335
Roof.....	43
Glass panel.....	43
Roof load.....	81
Roof rack	81
Route.....	165
Route information.....	182
Route planning method.....	165
Route settings.....	165

S

Safety alerts.....	165
Safety belts.....	54
Safety net	79
Safety prop.....	330
Save a favourite destination.....	176
Saved locations.....	176
SD card.....	163, 165
Search for Bluetooth device.....	196
Search radio station name.....	144
Seat adjustment	7, 46
Seat belt	8
Seat belt reminder	97
Seat belts	54
Seat heating.....	51
Seat position	45
Security code.....	119
Select a destination.....	176
Selecting the waveband.....	143
Selective catalytic reduction.....	233
Selector lever	241
Service	222, 310
Service display	93, 98
Service information	310
Services.....	128
Service vehicle soon	98
Settings.....	128
Setting the time.....	128
Setting the volume.....	128
Setting up the navigation system	165

Side airbag system	62
Side blind spot alert.....	256
Sideboards.....	327
Sidelights.....	109
Side turn lights	281
Side wind assist.....	247
Side windows.....	41
Simulcast.....	147
Slideshow.....	165
Sliding door	29
Sliding side door.....	29
Smartphone	
Phone projection.....	162
Software version.....	200
Sound optimisation.....	136
Spare wheel	300
Speed cameras.....	165
Speed dependent volume.....	137
Speed limiter.....	103, 250
Speedometer	90
Speed warning.....	103
Starting and operating.....	225
Starting off	17
Starting the engine.....	17, 226, 241
Station search.....	144
Station storing.....	146
Steering.....	224
Steering column controls.....	84, 121
Steering wheel adjustment	10, 84
Steering wheel controls	84

Step.....	335
Stop engine.....	99
Stop-start system.....	17, 102, 227
Storage.....	72, 337
Storage compartments.....	72
Storage net.....	73, 74
Stored stations.....	144
Sun visors	43
Suspension height.....	230
Suspension seat.....	46
Switching on/off.....	128
Swivelling shelf.....	73
Symbols	4
Symbols overview	189
System settings.....	138

T

Tachograph.....	103, 108
Tachometer	91
Tailboard.....	326
Tail lights	279
Technical data.....	333
Text information (Radio text).....	147
Theft-deterrent feature	119
Three-point seat belt	55
Thumbnails.....	160
Time.....	128
Tipper operation.....	328
Tone settings.....	136
Toolbox.....	332

Tools	289
Top-Tether.....	64
Touch operation overview.....	135
Touchscreen.....	104
Tow bar.....	264
Towing.....	264
Towing another vehicle	306
Towing a trailer.....	264
Towing equipment	265
Towing eye.....	305
Towing the vehicle	305
Traction Control system	246
Traffic announcements (TA).....	147
Traffic announcement volume... ..	137
Traffic information.....	182
Traffic info service.....	163
Traffic safety.....	117, 192
Trailer coupling.....	264
Trailer stability assist	265
Trailer towing	264
Transmission	16
Transmission display	93, 240
Tread depth	293
Treble.....	136
Trip computer	107, 128
Trip odometer	91
Trip report	128
Turbo engine warm-up.....	226
Turn lights	97, 112
Tyre chains	294

Tyre changing.....	298
Tyre designations	290
Tyre pressure	290
Tyre pressure monitoring system.....	101, 291
Tyre pressures	316
Tyre repair kit	295
Tyres	290
Tyres and wheel size, changing.	294

U

Underseat storage	74
Unpairing a mobile phone.....	196
Update FM list.....	146
Updating stations list.....	146
Upholstery.....	309
Usage.....	128, 143, 151, 165
USB drive.....	152
USB drives.....	153
USB memory stick.....	163, 165
USB port.....	152
USB socket.....	87, 153
Using smartphone applications. .	162
Using the display screen.....	128
Using the Infotainment system... ..	128
Using this manual	3, 117

V

Variable effort steering.....	99
Vehicle battery	273, 303
Vehicle checks.....	269, 332

Vehicle data.....	315
Vehicle data recording and privacy.....	321
Vehicle identification number	313
Vehicle information.....	128
Vehicle jack.....	289
Vehicle messages	105
Vehicle security.....	34
Vehicle specific data	3
Vehicle storage.....	268
Vehicle tools.....	289
Vehicle unlocking	6
Ventilation.....	207
Videos.....	161
Voice control.....	191
Voicemail box.....	200
Voice preferences.....	165
Voice recognition.....	190, 192
Voice tags.....	192
Volume.....	136, 192
Adaptation volume km/h.....	137
Low volume sound enhancement.....	136
Rear OFF.....	136
Speed dependent volume	128, 137
Traffic announcement volume.	137
Volume distribution.....	136
Volume control.....	200
Volume settings.....	137

W

Warning chimes	106
Warning lights.....	90
Warning triangle	80
Washer and wiper systems	14
Washer fluid	272
Washing the vehicle.....	307
Waveband selection.....	143
Waypoints.....	176, 182
Weather.....	165
Wheel changing	298
Wheel covers	294
Wheels and tyres	290
Wheel wrench.....	289
Where am I?.....	182, 199
Wide view mirror.....	39, 43
Window guard.....	79
Windows.....	40, 41
Windscreen.....	40
Windscreen wiper and washer	85
Winter tyres	290
Wiper blade replacement	276
WMA files.....	152

Copyright by Vauxhall Motors Ltd.

The information contained in this publication is effective as of the date indicated below. Vauxhall Motors Ltd. reserves the right to make changes to the technical specifications, features and design of the vehicles relative to the information contained in this publication, as well as changes to the publication itself.

Edition: July 2019, Vauxhall Motors Ltd.

Printed on chlorine-free bleached paper.

ID-VMVBORIE1907-en

