

Astra

2009 Models Edition 1





Sport Hatch SRi

FALL IN LOVE

with driving again

Choose Astra for its great style, truly involving chassis, efficient engines and innovative features. Discover how brilliantly it fits the way you live. And rekindle your passion for driving.

This brochure covers Astra Expression, Life, Club, Design, Elite, SXi, SRi and SRi Exterior Pack models only. Some of the models shown include options and accessories available at extra cost. And not all of the features described are available on every model. So please check in the Equipment section for further details. From time to time, we also offer alternative Astra models such as Special Editions, featured in their own separate literature or found on the Vauxhall website: www.vauxhall.co.uk

Environmental issues 14

Driving dynamics 16

Engines and transmissions 18

Safety and security 20

Driver's equipment 22

Comfort equipment 24

Versatility 26

Astra line-up 28

Options and accessories 36

Astra VXR 40

Colours and trims 44

Equipment 48

Technical data 58

You have your own opinions about style, but we think you'll appreciate Astra's dynamic looks. The five-door hatchback, spacious estate and three-door Sport Hatch have all had style updates. All you have to do is choose.





OPEN YOUR EYES.
And your heart will follow.





SIT BACK.

Take a different
perspective.

The optional Astra Sport Hatch panoramic windscreen will change your view forever. Extending over the driver's head, the effect is stunning and gives you a whole new driving experience.





BE MOVED.
With outstanding versatility.





Astra looks as good inside as out. It seemed logical to us that the team who designed the outside should style the interior too. And we think it's all the better for that. After all, it's your personal space. So make the most of it.

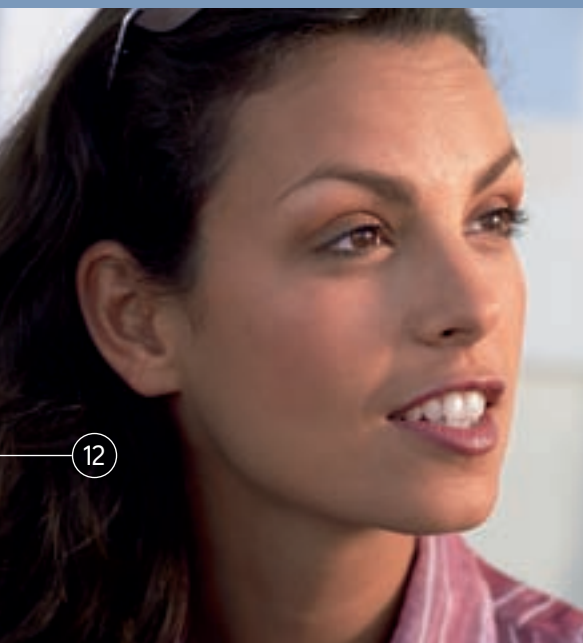



RELAX.

It's your own personal space.

RESPECT your world.

We all share a responsibility to look after our world. That's why Vauxhall has always been at the forefront of green automotive initiatives. Most recently, we are looking at ways to further reduce vehicle CO₂ emissions and working on even cleaner, alternative power sources, including zero-emission fuel cell technology.

But our commitment to preserving the environment goes even further. We have dramatically reduced manufacturing emissions for example, and our new vehicles use more recycled materials and more recyclable parts than ever before.

We also offer free and easily accessible, environmentally friendly, end-of-life vehicle disposal through our partners Autogreen Ltd. And under our EcoFlex Scrap Allowance* programme, if you buy a selected low-emission Astra model, we'll even offer you £1000 to take your old, higher emission car off the road.

That way, we reduce our environmental impact in every phase of every vehicle's life cycle. Because your world is our world, too.

*Terms and conditions apply. Please ask your Retailer for details.





The ability to thrill.

Every Astra is exciting to drive, striking a careful balance between ride comfort, agility and occupant safety. How do we do it? Through careful chassis tuning and the availability of electronic control systems, like ABS braking, Sport switch, ESP-plus and IDS-plus with Continuous Damping Control. Many models also benefit from an even more dynamic lowered and uprated sports chassis.



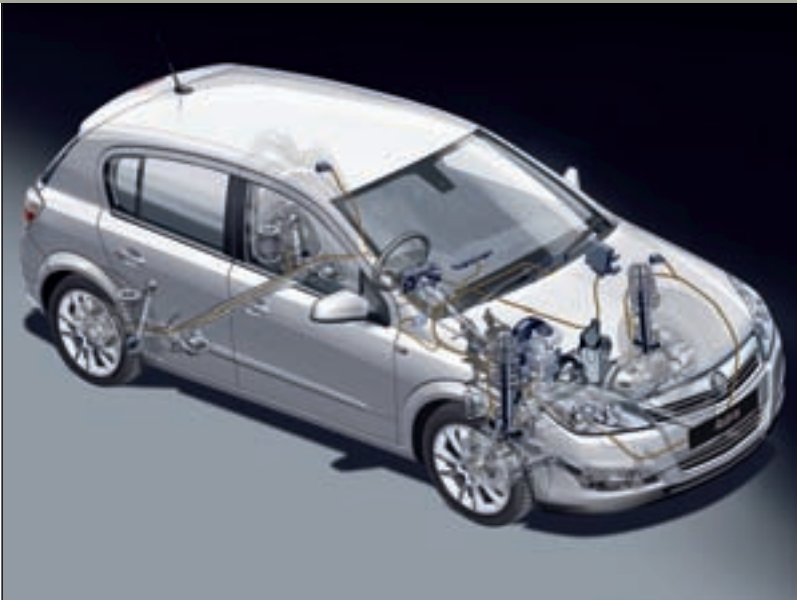

▼ **Electronic Stability Programme Plus (ESP-plus).** Whether it's a wet roundabout or a greasy road – one day you might meet a slippery surface that catches you out. That's the day you'll be glad you specified our latest ESP-plus system, which applies corrective braking to help you regain control.

Intelligent ABS. Most people appreciate the benefits of our standard Anti-lock Braking System (ABS) – and four-wheel disc brakes on most models – but Astra takes things even further. Cornering Brake Control (CBC), Electronic Brakeforce Distribution (EBD) and Emergency Brake Assist (EBA) make the car even easier to control and stop in emergency cornering and braking conditions.

▲ **Interactive Driving System-plus (IDS-plus).** There was a time when computer controlled damping was future technology for most drivers. Now it's available on Astra as part of the Interactive Driving System with Continuous Damping Control. Basically, it senses changes in the vehicle dynamics and automatically adjusts the damper rates – in real time – bringing you confident cornering behaviour and sharper handling with reduced body roll.



◀ **The Sport switch.** Performance to suit your mood. It's like having two cars in one, each with its own unique character and instant switching between the two. Push the button for quicker throttle response and sharper steering, plus sportier gear changes on automatic models.

You'll find more information and details of availability for all the features covered on this page in the Equipment and Technical Data section starting on page 48.





◀ **High tech petrols.** Astra comes with a wide range of multi-valve petrol engines, from 1.4 litres right up to the 240PS Astra VXR 2.0 litre turbo. Whatever their size, every one is brilliantly efficient. The well-respected Twinport 1.4i 16v model, for example, features a variable intake manifold for strong performance, high fuel efficiency and low emissions. And the two VVT engines – 115PS 1.6i 16v and 140PS 1.8i 16v – use Variable Valve Timing, allowing them to provide most of the maximum torque across a wide rev band. The result? Incredible flexibility through the gears, high power and low fuel consumption.

Efficient diesels. Common rail fuel injection technology features on all four Astra diesels – the sporty 1.9CDTi (120PS and 150PS), the 100PS 1.7CDTi and the super frugal 90PS 1.3CDTi. Superior performance and economy, with low emissions are guaranteed.

1.6i 16v Turbo. Available on Astra Design and SRi models only, the range-topping 1.6 litre Turbo petrol engine, with its turbocharger and intercooler, puts out an incredible 180PS and 230Nm of torque. Yet a high level of flexibility ensures it's equally at ease in traffic or at motorway speeds.



▼ **6-speed manual transmission.** 1.3CDTi and 1.9CDTi diesels and 1.6i 16v Turbo petrol models come with a six-speed manual gearbox, helping you make the most of their incredible potential.

▲ **Automatic transmission.** 1.8i 16v models are available with a four-speed automatic transmission. Design, Elite and SRi 1.9CDTi (120PS) models can be specified with a sophisticated six-speed variant.



▼ **Easytronic® transmission.** Choose the optional Easytronic transmission, available on 1.6i 16v VVT models, and you'll get a five-speed manual gearbox with a fully automatic mode. In manual mode, you simply push the lever forward or back to shift gears up or down. The fascia display tells you what gear you're in – 1 to 5, N for Neutral or A for Auto. Switch to fully automatic mode and it has many of the features of a regular automatic including a kickdown function. There's no clutch pedal so you can drive it on an automatic-only driving licence.





Power on demand.

Astra drivers don't miss out on engine choice. Nor power, flexibility and economy for that matter. There are no less than four seriously economical turbo diesels and four efficient petrol engines, including the 1.6i 16v VVT and a hot 180PS 1.6i 16v Turbo. Whichever you choose, you can be sure of strong response coupled with superb flexibility and tough emissions control.

The confidence of all-round safety and security.

Whichever model you choose, you can be assured of high levels of safety and, as you would expect, our security features look after your belongings as carefully as our safety features look after you.





▶ **Six airbags.** Every Astra front seat comes with front airbags and side-impact airbags – featuring a new ‘Thorax-Pelvis’ design to protect more of your body in the event of an impact. Most models also come with full-size curtain airbags as standard.



▶ **Adaptive Forward Lighting (AFL).**

The optional lighting system swivels the headlight beams up to 15 degrees for improved vision as you turn a corner. Above 65mph, it raises the dipped headlight beam slightly, also to increase safety – returning to normal beam automatically as speed is reduced. Turn to page 67 for more detailed information.



Adult occupant rating

ISOFIX. Astra’s outer rear seats are pre-fitted with rigid ISOFIX child seat fastening brackets, virtually eliminating the dangers of incorrect child seat installation. For maximum safety, you simply click a compatible Vauxhall ISOFIX accessory child seat into the mounting points engineered in the car.

Additional security features.

Remote control central deadlocking and an electronic engine immobiliser are standard on every Astra. So is door-to-door illumination, which keeps the dipped headlights and rear lights on for 30 seconds to light your way as you leave a garage or car park.

▶ **Keyless entry and start.** Simply carry the unique system key fob in your pocket or handbag and the car will automatically unlock as you operate a door or the tailgate. To start the engine, you depress the brake pedal and push the start button on the centre console and to stop the engine simply press the button again. There’s more information on page 66.



Optional active-safety front seat head restraints. Activated by the weight of the occupant’s body being forced back into the seat, the active-safety head restraint moves forwards and upright in the event of a rear impact, helping to reduce whiplash injuries.

The relaxation that comes with total control.

Astra's light airy interior space was carefully designed to suit real people of all shapes and sizes. The more relaxed you are, the easier it is to focus on the job in hand and enjoy the drive. So we've made it easy to find the perfect seating position, your favourite audio choice – even the quickest way home.

 **Big sounds.** If in-car audio is your thing, look no further. Astra is available with the latest technology including MP3 CD playback and an auxiliary-in socket so you can play tracks direct from your personal MP3 player. There's also an optional system that includes a CD autochanger. You'll find all the details on page 56/57.

 **Steering wheel mounted audio controls.** Standard on most Astra models, the ability to control your audio, phone and satellite navigation system from the steering wheel has genuine safety benefits. Many functions can be operated from the right and left buttons and thumb wheels.



▶ **Bluetooth®.** With the optional mobile phone system,* your phone interfaces with the audio unit, for full operation via the steering wheel controls and fascia display. Bluetooth® wireless connectivity with voice activation is included. Does not include phone or cradle. Turn to page 56/57 for more detailed information.

**Please refer to the Vauxhall Car and Accessory Price Guide for a list of phone-specific base units and cradles.*



▶ **Satellite navigation.** You'll never get lost in traffic with optional satellite navigation. It can determine your precise location and guide you to your destination by the best and fastest route. The Traffic Message Channel (TMC) function can even change the route according to breaking traffic news. For more detailed information see page 56/57.



▶ **Multi-function display.** All Astra audio information is displayed remotely on the separate multi-function display, which also shows the time, date and outside air temperature – with an ice warning. Specify the optional CD 70 satellite navigation system and the display is upgraded to colour.



▼ **Seat comfort.** Astra drivers are individuals in every sense. So every model has reach and rake adjustable steering. All drivers' seats are height adjustable. And the sports seats, available as part of the Leather Pack, feature tilt, lumbar adjustment and additional lateral support.



▲ **Rear parking distance sensor.** Available on virtually every model, this clever early warning system helps safeguard your car and pedestrians. When activated, the system beeps as you approach an obstruction, changing to a continuous tone when the object is 300mm away.

▶ **Multi-function trip computer.** Standard on Astra Elite, SXi and SRi models, this invaluable driver information system provides instantaneous and average fuel consumption, fuel consumed, average speed, distance travelled and range based on fuel remaining.



▲ **Cruise control.** The easy-to-use, tap-up tap-down cruise control is now available on most Astra models. It allows you to maintain a steady speed without keeping your foot on the throttle. So it's more comfortable on long journeys and easier to keep to speed limits too.



▲ **Full-length sunroof.** More light, more sunshine, more fresh air. The optional electric slide/tilt glass sunroof, available on Astra five-door hatchback and estate, extends virtually the entire length of the roof. The front section opens far wider than a typical sunroof. It comes with an interior blind and there's even a multi-position pre-set facility.

▶ **Panoramic windscreen.** Choose the optional panoramic windscreen on your Astra Sport Hatch model for a whole new driving experience. It's far more than just a windscreen, it's a window on the world, extending way back over the front seats, with heat-absorbing glass. The effect is like nothing you've experienced. There's also a full-length shading system with twin pull-out sunblinds should you need it.



▼ ▲ **Air conditioning and Electronic Climate Control (ECC).** From chilled air on hot days to quicker demisting on damp days, air conditioning makes for a fresher interior environment all year round. Move up to ECC and you can maintain your preferred interior temperature to within a single degree.



◀ **Sensing features.** Headlights that switch on automatically when it gets dark. Wipers that swing into action the moment they sense rain on the windscreen. A rear-view mirror that 'dips' when it detects glare from the car behind. All these features are available within the Astra range.





The ability to control your environment.

Wherever you're travelling, ultimate interior comfort comes down to total control of your own personal space. In Astra, you can choose more natural light, or more fresh air. You can adjust your interior temperature to the last degree. You can even let the car look after the headlights and windscreen wipers.



The flexibility to manage your non-stop lifestyle.

If you're looking for further space and flexibility to accommodate a non-stop lifestyle, here's the answer. The Astra estate. All the same driving excitement. All the comfort, safety and security. Looks that are every bit as dramatic. In fact, everything you love about Astra, with all the loadspace and versatility you'll ever need.



◀ ▼ **FlexOrganiser® Pack.** Sort your luggage space with this clever storage system comprising twin, horizontal rails plus a flexible arrangement of nets and dividers. It's further enhanced with a range of accessories – a side rail strap, divider, side net pocket and storage box.

▼ **Flexible load space.** If you're looking for space, we've got it. A cavernous load area that's as perfect for your business as it is for home and family. Plenty of practical features including a 60/40 split-folding rear seat and a particularly low loading height. And options such as a vertical load-restraining net and a 12-volt accessory socket – great for your accessory coolbox!



▼ **Retractable load area cover.** The easy to operate cover hides your luggage away from prying eyes.



▼ **Load restraint features.** The optional vertical load-restraining net (part of the Convenience Pack) provides a practical safety solution protecting the occupants from moving loads.



▶ **Spacious load area.** The wide Astra estate load platform offers up to a generous 470 litres of luggage space, extending to 1550 litres with the rear seats lowered. When you need to pack people and luggage into your Astra, the 60/40 split-folding rear seat back gives you maximum flexibility. Turn to page 63 for further information on the Astra estate loadspace.

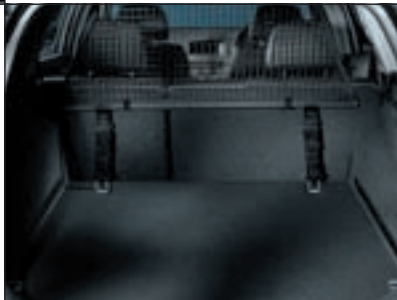



Relax and enjoy

THE DRIVE

with Astra, it's all about choice.

EXPRESSION

5-door Hatchback

LIFE

5-door Hatchback | Estate

Standard features include:

- Driver's, front passenger's and front seat side-impact airbags
- Anti-lock Braking System (ABS)
- CD player/stereo radio (CD 30)
- Air conditioning (1.7CDTi Life models only)
- Driver's seat height adjuster
- Electronic engine deadlock immobiliser
- Steering column adjustable for reach and rake
- Electrically operated front windows
- Service interval monitor
- Body-colour door mirrors
- Remote control central deadlocking
- Multi-function display panel
- Electro-hydraulic power-assisted steering
- Ellipsoid headlights

Exterior: Two-coat metallic paint is optional at extra cost.



Engine availability	Insurance groups (ABI)	
	20	50
1.4i 16v*	4E	7E
1.4i 16v**	4E	9E
1.6i 16v VVT**	6E	12E
1.6i 16v VVT Easytronic**	6E	12E
1.8i 16v VVT**	6E	15E
1.8i 16v VVT automatic**	6E	15E
1.3CDTi 16v (90PS)**	4E	9E
1.7CDTi 16v (100PS)**	6E	13E

Please note: Insurance groups relate to both the previous 20 group rating and the new 50 group rating.

*Available on Expression models only.

**Available on Life models only.

CLUB

5-door Hatchback | Estate

Standard features include:

- Driver's, front passenger's and front seat side-impact airbags
- Anti-lock Braking System (ABS)
- Steering column adjustable for reach and rake
- Electrically operated front windows
- CD player/stereo radio (CD 30)
- Remote control central deadlocking
- Service interval monitor

Additional features over and above Life model:

- Air conditioning
- Full-size curtain airbags
- 16-inch Structure wheels
- Electric door mirrors
- Body-colour side protection mouldings
- Steering wheel mounted audio controls
- Foldable key



Exterior: Two-coat pearlescent paint is optional at extra cost. Interior: Smoker Pack (retailer-fit only) is optional at extra cost.

Engine availability	Insurance groups (ABI)	
	20	50
1.4i 16v	5E	10E
1.6i 16v VVT	7E	13E
1.6i 16v VVT Easytronic	7E	13E
1.8i 16v VVT	7E	16E
1.8i 16v VVT automatic	7E	16E
1.3CDTi 16v (90PS)	5E	10E
1.7CDTi 16v (100PS)	6E	13E

Please note: Insurance groups relate to both the previous 20 group rating and the new 50 group rating.

DESIGN

Sport Hatch | 5-door Hatchback | Estate

Standard features include:

- Air conditioning
- Driver's, front passenger's and front seat side-impact airbags
- Full-size curtain airbags
- Anti-lock Braking System (ABS)
- Steering wheel mounted audio controls
- Steering column adjustable for reach and rake
- Remote control central deadlocking

Additional features over and above Club models:

- Six-way adjustable driver's seat
- Alpha/Morrocana trim
- 16-inch alloy wheels (steel space-saver spare)
- CD player with MP3 format/auxiliary-in socket/stereo radio (CD 30 MP3)
- Automatic lighting control
- Electrically operated rear windows (not Sport Hatch)
- Front fog lights
- Rain-sensitive windscreen wipers
- Indirect night lighting

Additional features on 1.6i 16v Turbo/1.9CDTi 16v (150PS) models:

- 17-inch 10-spoke alloy wheels
- Sport switch
- Electronic Stability Programme-plus
- Lowered and uprated sports suspension*

Exterior: Two-coat metallic paint, Adaptive Forward Lighting (AFL) and Sports Pack are optional at extra cost.



Engine availability	Insurance groups (ABI)	
	20	50
1.6i 16v VVT	7E	13E
1.6i 16v VVT Easytronic	7E	13E
1.8i 16v VVT	7E	17E
1.8i 16v VVT automatic	7E	17E
1.6i 16v Turbo (180PS)	14A	22A
1.7CDTi 16v (100PS)	6E	14E
1.9CDTi (120PS)	11A	21A
1.9CDTi (120PS) automatic	11A	21A
1.9CDTi 16v (150PS)	11A	21A

Please note: Insurance groups relate to both the previous 20 group rating and the new 50 group rating.

**Standard on all Sport Hatch variants.*

ELITE

5-door Hatchback

Standard features include:

- 16-inch alloy wheels (steel space-saver spare)
- Driver's, front passenger's and front seat side-impact airbags
- Full-size curtain airbags
- Anti-lock Braking System (ABS)
- CD player with MP3 format/auxiliary-in socket/stereo radio (CD 30 MP3)
- Leather-covered steering wheel
- Steering wheel mounted audio controls
- Rain-sensitive windscreen wipers
- Automatic lighting control
- Indirect night lighting
- Electrically operated front and rear windows

Additional features over and above Design models:

- Electronic climate control
- Cruise control
- Leather trim with sports front seats
- Electrically foldable door mirrors
- Multi-function trip computer

Exterior: Two-coat metallic paint is optional at extra cost



Engine availability	Insurance groups (ABI)	
	20	50
1.6i 16v VVT	7E	13E
1.6i 16v VVT Easytronic	7E	13E
1.8i 16v VVT	7E	17E
1.8i 16v VVT automatic	7E	17E
1.7CDTi 16v (100PS)	6E	14E
1.9CDTi (120PS)	8E	17E
1.9CDTi (120PS) automatic	8E	17E

Please note: Insurance groups relate to both the previous 20 group rating and the new 50 group rating.

SXi

Sport Hatch | 5-door Hatchback | Estate

Standard features include:

- Air conditioning
- Driver's, front passenger's and front seat side-impact airbags
- Full-size curtain airbags
- Anti-lock Braking System (ABS)
- Remote control central deadlocking
- Electrically operated front windows
- Foldable key

Additional features over and above Club models:

- 16-inch alloy wheels (steel space-saver spare)
- Lowered sports suspension (Sport Hatch only)
- Aluminium pedals (Sport Hatch only)
- Sports front seats with driver's lumbar adjustment
- CD player with MP3 format/auxiliary-in socket/stereo radio (CD 30 MP3)
- Multi-function trip computer
- Matt chrome-effect centre console
- Leather-covered sports steering wheel
- Front fog lights



Engine availability	Insurance groups (ABI)	
	20	50
1.4i 16v	5E	10E
1.6i 16v VVT	7E	13E
1.6i 16v VVT Easytronic	7E	13E
1.7CDTi 16v (100PS)	6E	13E
1.9CDTi (120PS)	8E	16E

Please note: Insurance groups relate to both the previous 20 group rating and the new 50 group rating.

SRI

Sport Hatch | 5-door Hatchback | Estate

Standard features include:

- Air conditioning
- Anti-lock Braking System (ABS)
- CD player with MP3 format/auxiliary-in socket/stereo radio (CD 30 MP3)
- Sports front seats with driver's lumbar adjustment
- Multi-function trip computer

Additional features over and above SXi models:

- 17-inch alloy wheels (steel space-saver spare)
- Remote control ultrasonic security alarm
- Rear spoiler
- Sport switch
- Electronic Stability Programme-plus (ESP-plus) with traction control

Additional features for SRI models with Exterior Pack:

- 18-inch alloy wheels
- VXR Styling Pack One

Exterior: Two-coat pearlescent paint is optional at extra cost.

Interior: Electronic climate control and Smoker Pack (retailer-fit only) are optional at extra cost.



Engine availability	Insurance groups (ABI)	
	20	50
1.8i 16v VVT	8E	18E
1.8i 16v VVT automatic	8E	18E
1.6i 16v Turbo (180PS)	16A	32A
1.7CDTi 16v (100PS)	7E	13E
1.9CDTi (120PS)	12E	21E
1.9CDTi (120PS) automatic	12E	21E
1.9CDTi 16v (150PS)	12E	21E

Please note: Insurance groups relate to both the previous 20 group rating and the new 50 group rating.

Vauxhall options and accessories are all about choice – selecting your new car, then personalising it to suit yourself. There's a choice of factory-fitted options and a huge range of retailer-fit accessories. You can also choose styling products from the VXR range as well as auto design specialist Irmischer International. Available individually or in special packs at great prices. You'll find further information on the following pages or just ask your Vauxhall retailer for more details.



VXR Styling

Inspired by our hugely successful racing team, VXR styling products reflect their experience, knowledge and passion for style and performance. Available on Astra as factory-fit option packs or accessories fitted by your Vauxhall retailer, the VXR range adds flair, personality and excitement to your car.



◀▶ Astra VXR Styling Pack One.

- Front lower spoiler
- Rear lower skirt
- Rear roof spoiler
- Side sills
- Aerial adaptor

Model illustrated (left) also features optional 18-inch five-spoke alloy wheels.



◀ Sports Pack.

- 17-inch 10-spoke alloy wheels (steel space-saver spare)
- 225/45 R 17 ultra-low profile tyres
- Sport switch
- Electronic Stability Programme-plus
- Lowered and uprated sports suspension (standard on Sport Hatch models)

OPTION PACKS AVAILABLE INCLUDE:

Premium Pack (Sport Hatch only).

- 18-inch five-spoke alloy wheels (steel space saver spare)
- 225/40 R 18 ultra-low profile tyres
- Leather seat facings in Saddle Brown
- Electrically heated sports front seats
- Zebrano-effect inserts on fascia and doors



▶ Leather Pack.

- Leather seat facings
- Electrically heated sports front seats with lumbar adjustment
- Front passenger's seat height adjuster
- Indirect door night lighting
- Height-adjustable centre rear seat head restraint



Sight and Light Pack.

- Rain-sensitive windscreen wipers
- Electro-chromatic anti-dazzle rear-view mirror
- Automatic Lighting Control (ALC)

▲ Convenience Pack (estate only).

- Vertical load-restraining net
- 12-volt auxiliary rear power socket



◀ FlexOrganiser® Pack (estate only).

- Four side rails
- Divider net
- Two connecting rods
- Elasticated bag with four clips

INDIVIDUAL OPTIONS INCLUDE:

- Adaptive Forward Lighting (AFL)
- Keyless entry and start
- Interactive Driving System-plus (IDS-plus) with Continuous Damping Control (CDC)
- Electronic Stability Programme-plus (ESP-plus)
- Remote control ultrasonic security alarm system
- Rear parking distance sensors
- Mobile phone system with Bluetooth®*
- Electrically operated slide/tilt sunroof
- Cruise control
- Electronic climate control



◀ Protection Pack.

- Full-size curtain airbags
- Active-safety front seat head restraints

*Please refer to the Vauxhall Car and Accessory Price Guide for a list of phone-specific cradles.

Vauxhall accessories are the right choice for your Astra. Whatever you're into, there's certain to be a Vauxhall accessory with your name on it, all fitted by trained Vauxhall professionals. We've only featured a small selection of what's available here. The Vauxhall Car Accessory Brochure gives further details or check out our website at www.vauxhall-accessories.com

Tow bar and 12N electrics. Tow in confidence with the detachable Astra tow bar. It won't get in the way when you don't need it. But it's easy to mount when you do. And naturally, it is tested to comply with top European standards. Astra accessory towing mirrors are also available (not illustrated).



Child seats. Vauxhall offers a range of child seats, ergonomically styled for comfort and safety. The Baby-Safe (for babies from birth to 13kg), and Kid (15-36kg) seats are fixed with a standard lap and diagonal seatbelt, while the Duo ISOFIX (9-18kg) can also be attached using the ISOFIX child seat restraint fittings, which are standard on the outer rear seats of all Astra models. The rigid ISOFIX anchoring mechanism virtually eliminates the dangers of incorrect child seat installation. Astra is also compatible with Vauxhall's new Top Tether system, designed to stop the top of ISOFIX child seats moving forward in a frontal collision. For further information, please ask for a copy of the Vauxhall Accessories Child Seat brochure available from your Vauxhall retailer.



Base carrier and roof box. The Vauxhall roof rack system begins with a base carrier, comprising two T-track roof bars which support a wide range of attachments. These include a choice of high capacity roof boxes, each one lockable and easy to fit.

FURTHER ACCESSORIES AVAILABLE INCLUDE:

- Thatcham approved alarm system
- Floor mats
- Cargo liner
- Mudflaps
- Headlight protectors
- Electrically-chilled 12-litre cool bag
- Premium bicycle carrier
- Side loading bicycle carrier
- Alloy ski carrier
- Anti-slip mat
- Portable satellite navigation system
- Steering wheel security bar

Rear parking distance sensor. This invaluable parking aid is mounted within the Astra rear bumper. Activated automatically when reverse gear is selected, it beeps as you approach an obstruction changing to a continuous tone when it's 300mm away.

Dog guard*. Keep your pet secure in the back of the car and protect the driver and passengers too with our heavy-duty steel dog guard. Custom designed to fit Astra estate models.



**May require additional fitting kit.*

VAUXHALL ACCESSORY PACKS

Vauxhall accessory packs bring together a selection of essential accessories at great prices, helping you to protect your car and equipping you for roadside emergencies.

Irmscher

Styling

Developed in conjunction with auto design specialists Irmscher International, Astra styling accessories perfectly complement the vehicle's lines, as well as being manufactured to the same exacting standards as the car itself. For availability details please ask your Vauxhall retailer.



▶ **Sports silencer.** For distinctive looks (with chrome-plated tailpipes) and a sportier exhaust note, these split oval design tailpipes are the perfect choice for your Astra. The rear bumper sports insert (also shown right) is available separately.



◀▶ **Protection Pack.**

- Velour mats
- Mudflaps
- Cargo liner



◀ **Irmscher alloy wheels.** They're the perfect way to personalise your Astra. With a huge range to choose from (style illustrated is Stila), and sizes from 15 to 19 inches, you're sure to find one to suit your style and budget. And don't forget to ask about our accessory wheel locking kits too.

▶ **Safety Pack.**

- First aid kit
- Warning triangle
- Hi-visibility vest



▶ **Cross hatch grille.** Being different is easy with the cross hatch front grille from Irmscher. Featuring an aluminium upper strip with a laser-etched 'Irmscher' logo it adds style and individuality.







ASTRA VXR

This is extra-sensory stimulation. Cars with soul and power to make you feel alive, electrified and inspired. A range of driver-focused, performance machines for the road, born on the track.



- > Unique VXR body styling
- > Recaro sports front seats
- > 18-inch alloy wheels
- > 19-inch alloy wheels with anthracite inner optional at extra cost (illustrated far right)
- > Trapezoidal centre exit exhaust tuned for sound
- > Keyless entry and start



DISCOVER 6.2SEC
0-60MPH

VXR takes all the experience, knowledge and passion gained from over 110 British Touring Car Championship (BTCC) wins and crystallises it into a range of high performance road cars. Since first entering the BTCC in 1989, Vauxhall's works team has won no less than 18 titles and has become the most successful manufacturer in the modern era. As defending Driver and Manufacturer title holders, we'll be all-out to maintain this unrivalled record throughout the 2008 HiQ MSA British Touring Car Championship season.

For more information on the Astra VXR please ask your Vauxhall retailer for a copy of the latest VXR range brochure.

"IT'S GOT THE LOOKS, AND ITS EXHILARATING WILD SIDE AND SHEER PACE MAKE MOST OF ITS RIVALS FEEL A BIT STEADY IN COMPARISON."

EVO MAGAZINE - JULY 2007





ASTRA VXR.

Let's get straight to the point. No ifs or buts. Astra VXR is Vauxhall's hottest hatch... ever. Think 240PS and 320Nm with 0-60mph in 6.2 seconds. Think 2.0i 16v turbo, six-speed gearbox and the low, flat ride of a genuine performance car. And on top of all that – drop-dead styling that went straight from concept car to showroom without any compromise. If you've got buttons, Astra VXR will press them. Hard.

Colour your world with excitement.

Funny thing colour. It reflects our personality. Cheers us up and brings us together. And gives us a real opportunity to express our creativity. So what's it going to be?



Due to the limitations of the printing process the colours reproduced may vary slightly from the actual paint colour or trim material. As a result they should be used as a guide only. Your Vauxhall retailer has a comprehensive display of all our paint samples and trim swatches.

▶ Glacier White – solid



▶ Royal Blue – solid



▶ Power Red – solid



▶ Technical Grey – metallic



▶ Metro Blue – metallic



▶ Green Spirit – metallic



▶ Panacotta – pearlescent



▶ Star Silver – metallic



▶ Ultra Blue – pearlescent



▶ Silver Lightning – metallic



▶ Black Sapphire – pearlescent



▼ Alpha cloth, Charcoal



▼ Twist cloth, Charcoal

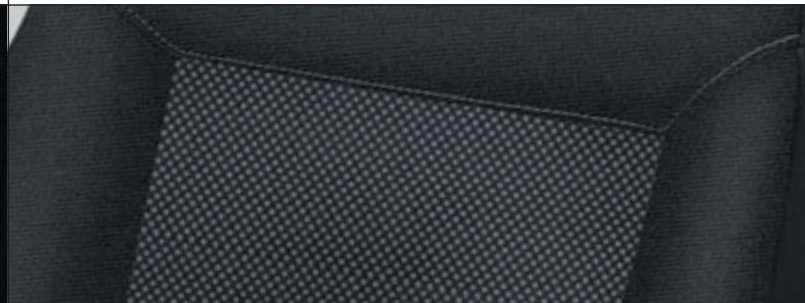

▼ Silver Alpha cloth/Morrocana, Charcoal

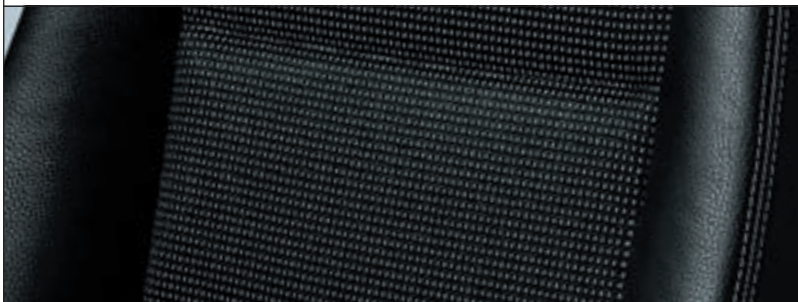

▼ Leather trim, Saddle Brown

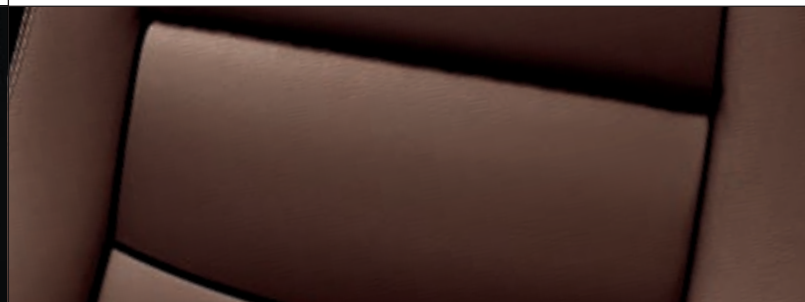

Exterior colours

Model, trim name and trim colour

	Expression/ Life Alpha cloth	Club Twist cloth	Design Silver Alpha cloth/ Morrocana trim	Design Leather†	Elite Leather	SXi/SRi Silver Alpha cloth	SXi/SRi Leather*
Solid							
Glacier White	Charcoal	Charcoal	Charcoal	-	Charcoal	Charcoal	Charcoal
Royal Blue	Charcoal	Charcoal	Charcoal	-	Charcoal	Charcoal	Charcoal
Power Red	Charcoal	Charcoal	Charcoal	-	Charcoal	Charcoal	Charcoal
Two-coat metallic*							
Technical Grey	Charcoal	Charcoal	Charcoal	Saddle Brown	Charcoal	Charcoal	Charcoal
Green Spirit	Charcoal	Charcoal	Charcoal	Saddle Brown	Charcoal	Charcoal	Charcoal
Star Silver	Charcoal	Charcoal	Charcoal	Saddle Brown	Charcoal	Charcoal	Charcoal
Silver Lightning	Charcoal	Charcoal	Charcoal	Saddle Brown	Charcoal	Charcoal	Charcoal
Metro Blue	Charcoal	Charcoal	Charcoal	Saddle Brown	Charcoal	Charcoal	Charcoal
Two-coat pearlescent*							
Panacotta	Charcoal	Charcoal	Charcoal	Saddle Brown	Charcoal	Charcoal	Charcoal
Ultra Blue	Charcoal	Charcoal	Charcoal	Saddle Brown	Charcoal	Charcoal	Charcoal
Black Sapphire	Charcoal	Charcoal	Charcoal	Saddle Brown	Charcoal	Charcoal	Charcoal

* = Optional at extra cost. † = Optional at extra cost as part of the Premium Pack.

▼ Leather trim, Charcoal

▼ Silver Alpha cloth, Charcoal

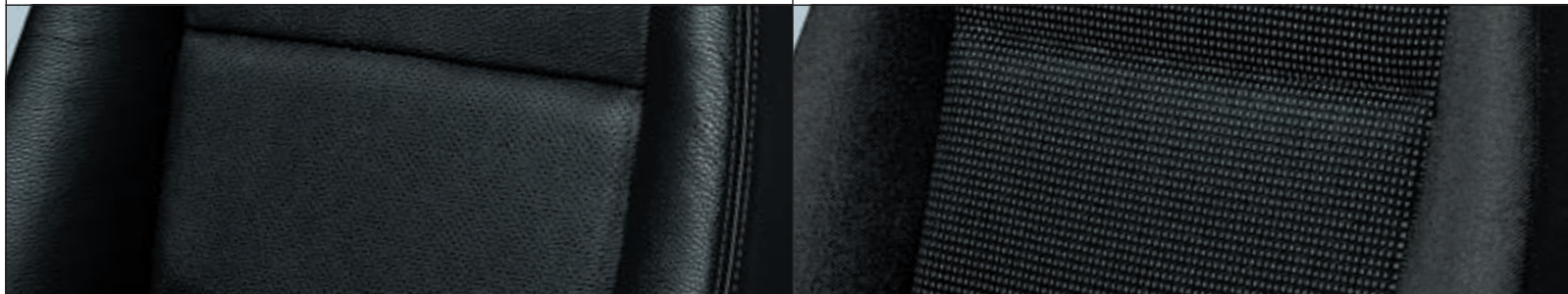

Contents

Equipment

Model availability	48
Safety	
Security	

Heating and ventilation	49
Facia, instruments and controls	
Interior lighting	

Seating and upholstery	50
Additional interior features	

Mechanical	51
Exterior styling and protection	

Wheels and tyres	52
Exterior lighting	

Exterior and convenience features	53
-----------------------------------	----

Option packs	54
--------------	----

Audio, communication and navigation	56
-------------------------------------	----

Technical data

Petrol Engines	58
----------------	----

Diesel Engines	59
----------------	----

Petrol engine performance, fuel economy and emissions	60
---	----

Diesel engine performance, fuel economy and emissions	61
---	----

Exterior dimensions	62
---------------------	----

Interior dimensions	63
Estate loadspace dimensions	
Luggage capacities	

Vauxhall Assistance and warranties, transmissions, suspension, brakes and steering	64
--	----

Weights and towing data	65
-------------------------	----

Features explained	66
--------------------	----

Model availability

	Exp.	Life	Club	Design	Elite	SXi	SRi	SRi XP
Sport Hatch				■		■	■	■
5-door hatchback	■	■	■	■	■	■	■	■
Estate		■	■	■		■	■	■

Safety

Standard features • Driver's airbag • Front passenger's airbag • Front seat side-impact airbags • Electronic park/brake pedal safety interlock on models with automatic transmission • Energy-absorbing steering column • Pedal release system – Reduces potential injury to the driver's legs and feet during a severe frontal impact • Laminated windscreen • Side-impact protection beams • Integral protective side door padding • Reinforced passenger safety cell

• ISOFIX child seat restraint system for outer rear seats (does not include child seat) – Secures ISOFIX child safety seats to the vehicle itself, virtually eliminating the dangers that can result from improper installation • Child-proof locks on rear doors

• Anti-lock Braking System (ABS) • Electronic Brakeforce Distribution (EBD) • Cornering Brake Control (CBC) – see **D1** on page 66 • Emergency Brake Assist (EBA) – Increases applied brake force in emergency braking situations

• Height-adjustable front and outer rear seat head restraints • Pyrotechnic front body-lock seatbelt pretensioner system – Tightens the seatbelt during the early stages of a frontal impact • Front and outer rear seatbelt force limiters – Reduces potential upper body injuries during a frontal impact • Height-adjustable inertia-reel front seatbelts • Centre lap and diagonal inertia-reel rear seatbelt • Anti-submarining ramps in all seats – Help prevent occupants sliding underneath the lap belt during a collision.

Additional features

	Exp.	Life	Club	Design	Elite	SXi	SRi	SRi XP
Electronic Stability Programme-plus (ESP-plus) with traction control ¹ – see D2 on page 66	○	○	○	○ ²	○ ³	○	●	●
Full-size curtain airbags	□	□	●	●	●	●	●	●
Active-safety front seat head restraints	□	□						
Height-adjustable centre rear seat head restraint					●	□	□	□

Security

Standard features • Remote control central deadlocking (doors, tailgate, fuel filler flap) • Visible Vehicle Identification Number (VIN) plate • 'Key left in ignition' audible warning • Freewheeling door locks • Electronic engine deadlock immobiliser • Electronic theft protection for audio equipment • Locking wheel bolts for alloy wheels (where fitted) • Driver's internal central locking switch • Door-to-door illumination – Keeps the headlights and rear lights on for 30 seconds after the car doors are locked.

Additional features

	Exp.	Life	Club	Design	Elite	SXi	SRi	SRi XP
Keyless entry and start – see D3 on page 66			○	○	○	○	○	○
Remote control ultrasonic security alarm system		○ ⁴	○	○	○	○	●	●

Heating and ventilation

Standard features • Air blend heater with four-speed fan • Side window demist vents and adjustable face-level air vents
• Interior pollen filter

Additional features

	Exp.	Life	Club	Design	Elite	SXi	SRi	SRi XP
Air conditioning with air recirculation		● ⁵	●	●		●	●	●
Electronic Climate Control (ECC) incorporating air conditioning with air recirculation			○	○	●	○	○	○

Facia, instruments and controls

Standard features • Rev counter • Multi-function display showing time, date, audio information and outside air temperature (with ice warning function) • Digital clock with automatic RDS time adjustment • Steering column adjustable for reach and rake
• Electronic odometer and trip odometer • Instrument panel light dimmer • Handbrake-on/low brake fluid level and low fuel level warning lights • Service interval monitor

Additional features

	Exp.	Life	Club	Design	Elite	SXi	SRi	SRi XP
Three-spoke steering wheel	●	●	●					
Three-spoke leather-covered steering wheel				●	●			
Three-spoke leather-covered sports steering wheel						●	●	●
Black instruments	●	●						
Black instruments with chrome edging			●	●	●			
Black sports instruments with chrome edging						●	●	●
Multi-function trip computer					●	●	●	●
Cruise control			○	○	●	○	○	○

Interior lighting

Features

	Exp.	Life	Club	Design	Elite	SXi	SRi	SRi XP
Fade up/fade down courtesy lighting operated by front and rear door switches	●	●	●	●	●	●	●	●
Illuminated luggage area and glovebox	●	●	●	●	●	●	●	●
Two rear reading lights and front map reading lights integral with courtesy light			●	●	●	●	●	●
Indirect door night lighting					●	□	□	□



Electronic Stability Programme-plus.



Black instruments with chrome edging.

- = Standard equipment.
- = Optional at extra cost.
- = Only available as part of an extra-cost option pack (see page 54 for details).
- = This bodystyle is available with this trim level.
- Exp. = Expression.
- SRi XP = SRi with Exterior Pack.

- 1 = ESP-plus is switchable on Design models fitted with optional Sports Pack and SRi models.
- 2 = Standard on 1.6i 16v Turbo/1.9CDTi (120PS)/1.9CDTi 16v (150PS) models. Also available as part of an extra-cost option pack.
- 3 = Standard on 1.9CDTi (120PS) models.
- 4 = Front and rear reading lights are also included.
- 5 = Non air-conditioned models available (excluding 1.7CDTi 16v).



Aluminium pedals.



Driver's sunglasses holder.



Electro-chromatic anti-dazzle rear-view mirror.

Seating and upholstery (see pages 46/47 for more details)

Standard features • Driver's and front passenger's seats with reach and recline adjustment • Driver's seat height adjuster
• 60/40 split-folding rear seat back

Additional features	Exp.	Life	Club	Design	Elite	SXi	SRI	SRI XP
Alpha cloth seat trim	●	●						
Twist cloth seat trim			●					
Silver Alpha cloth seat trim with Morrocana-trimmed side bolsters				●				
Silver Alpha seat trim						●	●	●
Leather seat facings (includes heated front seats with variable temperature settings)				□ ⁶	●	□	□	□
Front passenger's seat height adjuster			□	□	●	□	□	□
Sports front seats				□ ⁶	●	●	●	●
Lumbar adjustment for driver's seat			□	●	●	●	●	●
Tilt adjustment for driver's seat			□	●	●	□	□	□
Lumbar adjustment for front passenger's seat			□	□	●	□	□	□
Tilt adjustment for front passenger's seat			□	□	●	□	□	□

Additional interior features

Standard features • 12-volt auxiliary power socket within centre console • Chrome-effect internal door handles • Glovebox divider
• Fleece velour carpet • Front door pockets • Fully carpeted luggage area • Carpeted rear seat back • Load restraint lashing eyes
• Retractable luggage compartment cover (estate only) • Drinks holder between front seats

Additional features	Exp.	Life	Club	Design	Elite	SXi	SRI	SRI XP
Satin stone-effect centre console	●	●	●					
Charcoal-effect inserts on facia and doors	●	●						
Satin stone-effect inserts on facia and doors			●					
Matt chrome-effect inserts on facia and doors				●	●			
Piano black-effect centre console				●	●			
Matt chrome-effect centre console and inserts on facia and doors						●	●	●
Aluminium pedals (Sport Hatch only)						●	●	●
Driver's sunglasses holder				●	●	●	●	●
Twin sunvisors incorporating illuminated driver's and front passenger's vanity mirrors with covers				●	●	●	●	●
Electro-chromatic anti-dazzle rear-view mirror				●	●	□ ⁷	□ ⁷	□ ⁷
12-volt auxiliary power socket located in luggage compartment (estate only)			□	□		□	□	□
Vertical load-restraining net (estate only)		○	○ ⁸	○ ⁸		○ ⁸	○ ⁸	○ ⁸
Load area sill protection (estate only)			●	●		●	●	●

Mechanical

Standard features • Electro-hydraulic power-assisted steering • Lightweight MacPherson strut front suspension and torsion beam rear suspension with gas-pressure dampers • Catalytic converter

Additional features	Exp.	Life	Club	Design	Elite	SXi	SRi	SRi XP
Five-speed manual gearbox (1.4i 16v/1.6i 16v VVT/1.8i 16v VVT/1.7CDTi 16v)	●	●	●	●	●	●	●	●
Six-speed manual gearbox (1.3CDTi 16v (90PS)/1.9CDTi (120PS)/1.9CDTi 16v (150PS)/1.6i 16v Turbo)		●	●	●	●	●	●	●
Easytronic five-speed transmission (1.6i 16v VVT only) ⁹		○	○	○	○	○		
Six-speed automatic transmission (1.9CDTi (120PS) only)				○	○		○	○
Four-speed automatic transmission (1.8i 16v VVT only)		○	○	○	○		○	○
Lowered and uprated sports suspension ¹⁰				□ ¹¹		● ¹²	●	●
Sport switch – see D4 on page 67				□ ¹¹			●	●
Interactive Driving System-plus (IDS-plus) with Continuous Damping Control (CDC) – see D5 on page 67				○ ¹³			○	○

Exterior styling and protection

Features	Exp.	Life	Club	Design	Elite	SXi	SRi	SRi XP
Dark-tinted Solar Protect [®] glass (excludes windscreen and front door windows) (estate only)				●			●	●
Black body side-protection mouldings	●	●						
Body-colour side-protection mouldings			●	●	●	●	●	●
Black foil on door pillars ¹⁴				●	●	●	●	●
Black door handles	●	●						
Body-colour door handles			●	●	●	●	●	●
Chrome-effect front door sill covers				●	●	●	●	●
Chrome-effect window side mouldings				●	●	● ¹⁵	● ¹⁵	● ¹⁵
Body-colour door mirrors	●	●	●	●	●	●	●	●
Body-colour front lower spoiler, rear lower skirt and side sills			□	□	□	□	□	●
Body-colour rear spoiler			□	□	□	□	●	●
Visible stainless steel exhaust tailpipe (exc. 1.4i 16v/1.7CDTi 16v (100PS)) ¹⁶						●	●	●



Five-speed Easytronic transmission.

● = Standard equipment.
 ○ = Optional at extra cost.
 □ = Only available as part of an extra-cost option pack (see page 54 for details).
 Exp. = Expression.
 SRi XP = SRi with Exterior Pack.

- 6 = Available as part of Premium Pack only.
 7 = Available on Sport Hatch and 5-door hatchback only. Not available in conjunction with Panoramic windscreen.
 8 = Also available as part of an extra-cost option pack.
 9 = Not available in conjunction with Sports Pack.
 10 = Standard on all Sport Hatch models.
 11 = Standard on 1.6i 16v Turbo/1.9CDTi 16v (150PS) models. Not available with Easytronic transmission.
 12 = Sport Hatch models only.
 13 = Only available in conjunction with Sports Pack (Sports Pack is standard on 1.6i 16v Turbo/1.9CDTi 16v (150PS) models).
 14 = Deleted when optional Black Sapphire two-coat pearlescent paint is specified.
 15 = Only available on estate models.
 16 = Sport Hatch, 5-door hatchback and 1.6i 16v Turbo estate models only.



18-inch five-spoke alloy wheels.



17-inch five-spoke alloy wheels.



17-inch 10-spoke alloy wheels.

Wheels and tyres

Features	Exp.	Life	Club	Design	Elite	SXi	SRi	SRi XP
15-inch steel wheels with flush wheel covers and 195/65 R 15 low profile tyres	●	●						
16-inch Structure wheels with 205/55 R 16 ultra-low profile tyres			●					
16-inch seven-spoke alloy wheels with 205/55 R 16 ultra-low profile tyres				●	●			
16-inch Twin Spoke alloy wheels with 205/55 R 16 ultra-low profile tyres						●		
17-inch five-spoke alloy wheels with 225/45 R 17 ultra-low profile tyres							●	
17-inch 10-spoke alloy wheels with 225/45 R 17 ultra-low profile tyres				□ ¹¹				
18-inch five-spoke alloy wheels with 225/40 R 18 ultra-low profile tyres				□			○	●
Steel space-saver spare wheel/tyre	●	●	●	●	●	●	●	●
Full-size steel spare wheel/tyre	○	○	○	○ ¹⁷	○	○	○ ¹⁸	

Exterior lighting

Standard features • Lights-on audible warning • LED centre brake light • Reversing light, rear fog light, hazard warning lights, side repeat indicators • Ellipsoid headlights • Electric headlight beam levelling

Additional features	Exp.	Life	Club	Design	Elite	SXi	SRi	SRi XP
Chrome-effect headlights	●	●	●	● ¹⁹	●			
Dark-style headlights				● ²⁰		●	●	●
Adaptive Forward Lighting (AFL) incorporating dark-style bi-xenon headlights with dynamic beam levelling and high-pressure washers – see D6 and D7 on page 67				○	○	○	○	○
Front fog lights				●	●	●	●	●
Automatic Lighting Control (ALC)				●	●	□ ⁷	□ ⁷	□ ⁷

Exterior and convenience features

Standard features • Electrically operated front windows with safety autoreverse and one-touch facility • Green-tinted glass
 • Heated rear window with automatic timed cut-off • Intermittent rear window wash/wipe • Windscreen wipers with variable intermittent facility and flick-wipe • Twin-jet windscreen washer nozzles • Gas-assisted tailgate struts

Additional features	Exp.	Life	Club	Design	Elite	SXi	SRI	SRI XP
Internally adjustable and foldable door mirrors (wide-angle on driver's side)	●	●						
Twin electrically adjustable/heated and manually foldable door mirrors (wide-angle on driver's side)			●	●		●	●	●
Twin electrically adjustable/heated and electrically foldable door mirrors (wide-angle on driver's side)			○	○	●	○	○	○
Electrically operated rear windows with safety autoreverse and one-touch facility (5-door hatchback and estate only)				●	●			
Folding key (one supplied)			●	●	●	●	●	●
Electrically operated slide/tilt full-length glass sunroof with multi-position pre-set facility and interior blind (5-door hatchback and estate only)			○	○	○	○	○	○
Rain-sensitive windscreen wipers				●	●	□ ⁷	□ ⁷	□ ⁷
Black roof rails (estate only)		●	●			●		
Alloy-effect roof rails (estate only)				●			●	●
Two-coat metallic or pearlescent paint	○	○	○	○	○	○	○	○
Two-tone horn				●	●	●	●	●
Rear parking distance sensor			○	○	○	○	○	○
Panoramic windscreen (Sport Hatch only) ²¹				○		○	○	○



Electrically foldable door mirrors.

- = Standard equipment.
- = Optional at extra cost.
- = Only available as part of an extra-cost option pack (see page 54 for details).
- Exp. = Expression.
- SRI XP = SRI with Exterior Pack.

- 7 = Available on Sport Hatch and 5-door hatchback only. Not available in conjunction with Panoramic windscreen.
- 11 = Standard on 1.6i 16v Turbo/1.9CDTi 16v (150PS) models. Not available with Easytronic transmission.
- 17 = 16-inch spare wheel/tyre supplied if ordered in conjunction with Sports Pack. Not available in conjunction with Premium Pack.
- 18 = 16-inch spare wheel/tyre supplied. Not available in conjunction with 18-inch alloy wheels.
- 19 = 5-door hatchback and estate models only.
- 20 = Fitted to all Sport Hatch models and in conjunction with optional AFL on 5-door hatchback and estate models.
- 21 = Panoramic windscreen deletes driver's sunglasses holder; illuminated driver's and front passenger's vanity mirrors and ultrasonic function from alarm system. Not available in conjunction with Sight and Light Pack, mobile phone system with Bluetooth® or Glacier White exterior paint. Roof panel is coloured black.

● = Standard equipment.
○ = Optional at extra cost.
Exp. = Expression.
SRiXP = SRi with Exterior Pack.

- 7 = Available on Sport Hatch and 5-door hatchback only.
Not available in conjunction with Panoramic windscreen.
10 = Standard on all Sport Hatch models.
11 = Standard on 1.6i 16v Turbo/1.9CDTi 16v (150PS) models. Not available with Easytronic transmission.
22 = Only available on 1.6i 16v Turbo and 1.9CDTi 16v (150PS) Sport Hatch models.
23 = Only available in conjunction with Seat Comfort Pack One.

Option pack availability

	Exp.	Life	Club	Design	Elite	SXi	SRi	SRi XP
Premium Pack				○ ²²				
Convenience Pack (estate only)			○	○		○	○	○
Seat Comfort Pack One			○	●	●	○	○	○
Seat Comfort Pack Two			○ ²³	○	●	○ ²³	○ ²³	○ ²³
Leather Pack					●	○	○	○
Sight and Light Pack				●	●	○ ⁷	○ ⁷	○ ⁷
VXR Styling Pack One			○	○	○	○	○	●
Sports Pack				○ ¹¹				
Protection Pack	○	○						
FlexOrganiser® Pack (estate only)			○	○		○	○	○

Premium Pack (Sport Hatch only)

- 18-inch five-spoke alloy wheels with 225/40 R 18 tyres
- Leather seat facings in Saddle Brown
- Electrically heated sports front seats
- Zebrano-effect inserts on facia and doors

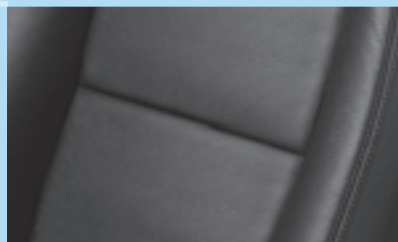

Convenience Pack (estate only)

- Vertical load-restraining net
- 12-volt auxiliary power socket located in luggage compartment



Seat Comfort Pack One

- Driver's seat with tilt and lumbar adjustment

Seat Comfort Pack Two

- Front passenger's seat with height, tilt and lumbar adjustment



Leather Pack

- Leather seat facings
- Electrically heated sports front seats with tilt and lumbar adjustment
- Indirect door night lighting
- Height-adjustable centre rear seat head restraint
- Front passenger's seat height adjuster

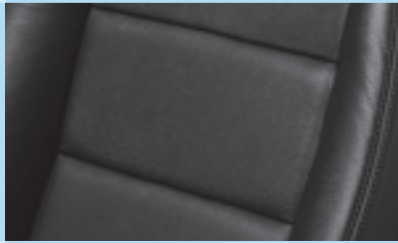

Sight and Light Pack

- Rain-sensitive windscreen wipers
- Electro-chromatic anti-dazzle rear-view mirror
- Automatic lighting control



VXR Styling Pack One

- Body-colour front lower spoiler/rear lower skirt/rear roof spoiler (standard on SRi) and side sills
- Aerial adaptor



Sports Pack

- 17-inch 10-spoke alloy wheels with 225/45 R 17 tyres
- Up-rated sports steering
- Sport switch
- Electronic Stability Programme-plus
- Lowered and up-rated sports suspension¹⁰



Protection Pack

- Full-size curtain airbags
- Active-safety front seat head restraints



FlexOrganiser® Pack (estate only)

- Divider net
- Four side rails
- Elasticated bag with four clips





Remote colour monitor (CD 70).



CD player/stereo radio (CD 30).

Audio, communication and navigation

Features	Exp.	Life	Club	Design	Elite	SXi	SRI	SRI XP
CD player/stereo radio (CD 30) • CD player • AM/FM stereo radio with 24 station presets • RDS with Traffic Programme • Remote display • 6 speakers	●	●	●					
CD player with MP3 format/stereo radio (CD 30 MP3) • CD player with MP3 format • Auxiliary-in socket • AM/FM stereo radio with 24 station presets • RDS with Traffic Programme • Remote display • 7 speakers		○25	○	●	●	●	●	●
CD autochanger with MP3 format/DAB stereo radio (CDC 40 DAB) (deletes auxiliary-in socket) ²⁴ • Integral six-disc CD autochanger with MP3 format • AM/FM/DAB (Digital Audio Broadcast) stereo radio with 36 station presets • RDS with Traffic Programme • Remote graphic information display • 35 watts per channel output • 7 speakers		○25	○	○	○	○		
CD autochanger with MP3 format/stereo radio (CDC 40) (deletes auxiliary-in socket) • Integral six-disc CD autochanger with MP3 format • AM/FM stereo radio with 36 station presets • RDS with Traffic Programme • Remote graphic information display • 35 watts per channel output • 7 speakers		○25	○	○	○	○	○	○
Satellite navigation/CD player with MP3 format/stereo radio (CD 70) • Satellite navigation system • CD player with MP3 format • Auxiliary-in socket • AM/FM stereo radio with 40 station presets • RDS with Traffic Programme • Remote colour monitor • 20 watts per channel output • 7 speakers		○26	○	○	○	○	○	○
Mobile phone system with Bluetooth® (does not include phone or phone-specific cradle) ²⁷		○26	○	○	○	○	○	○
Steering wheel mounted audio controls			●	●	●	●	●	●
Roof-mounted flexible aerial	●	●	●	●	●	●	●	●

- = Standard equipment.
- = Optional at extra cost.
- Exp. = Expression.
- SRI XP = SRI with Exterior Pack.

24 = Not available in conjunction with VXR Styling Pack One.

25 = Steering wheel mounted audio controls are also included.

26 = Steering wheel mounted audio controls and front and rear reading lights are also included.

27 = Not available in conjunction with Panoramic windscreen.

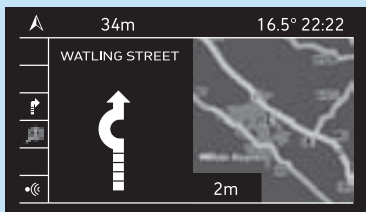

Satellite navigation

The CD 70 satellite navigation system uses the international network of GPS (Global Positioning System) satellites, linked to a comprehensive CD-ROM mapping system, to determine your precise location and guide you to your chosen destination virtually anywhere in mainland Britain.

Vauxhall's satellite navigation systems have been widely acclaimed for their ease of use and high level of information. The CD-ROM-driven system has been further enhanced for Astra. There is now a split-screen facility, whereby half of the screen displays the route as a map, while directional arrows give immediate information about road junctions. The audible direction guidance prompt now gives details of road numbers and motorway junction numbers, while you can also plan your route to avoid toll roads, if required.

The CD 70 also features Traffic Message Channel (TMC), a specific application of RDS used for broadcasting real-time traffic information, delivered to the driver either visually or verbally. TMC can also offer dynamic route guidance – alerting the driver to a problem on the planned route and calculating an alternative route to avoid the incident.

CD 70 standard features

- Split-screen facility displaying directional symbols and route on map
- Audio/voice direction guidance prompt
- Automatic re-routing on request
- CD-ROMs available for all major European countries
- CD-ROM may be replaced by audio CD after route is selected
- Display of estimated time remaining and distance to destination
- Exact location of vehicle using the GPS (Global Positioning System) and speed sensor
- Store up to 100 personal destinations
- Last 10 destinations stored automatically
- Traffic Message Channel (TMC)

Digital Audio Broadcast (DAB) facility

Now widely available in the UK, digital audio broadcasts offer the user a variety of advantages over traditional FM, starting with the digital quality sound which is immune to any hiss or crackle.

You'll often find a broader range of stations on offer too, many of which are not available on FM, and listening to them couldn't be easier – you simply select the station, by name, from the displayed list, thus removing the need to retune or look for stations when travelling around. Some stations will even display the artists' names and song titles on the car's graphic display, while they're played.

MP3 CD player

An MP3 is a compressed sound or music file and, due to its small size, it takes up less space on a compact disc, which means that more tracks can be recorded onto a CD. It's possible to fit almost 10 hours of music onto one CD, and, in a way, turns a single-disc CD/MP3 player into a multi-disc autochanger.

Mobile phone system with Bluetooth®

Vauxhall's optional factory-fit dual-band mobile phone system has been considerably enhanced. Now fully integrated into the audio and communication system, it also features voice control and will connect wirelessly to phones with Bluetooth® technology.

All the required information is displayed on the graphic information display when a mobile phone is in use, while the menus are easily navigated by either the steering wheel audio controls or the multi-function button on the radio. Certain functions can also be controlled by voice activation.

The mobile phone system can be further enhanced by fitting a phone-specific cradle, available as a Vauxhall Accessory. The cradle offers a secure location for your phone, while simultaneously charging the phone's battery and connecting its antenna to the car's external aerial. A list of compatible cradles is featured in the Car and Accessory Price Guide.

Auxiliary-in socket

The auxiliary-in socket allows you to connect your portable MP3 music player directly into the car's audio system. All you need is your music player and a suitable connecting lead and you can listen to all your favourite tunes through your car's speaker system.

When using an MP3 player in the car the majority of the controls, such as track selection, remain solely on the player, while only the volume is controlled via the car's regular audio controls.

NB: Auxiliary-in socket is not available in conjunction with CDC 40 audio units.



Steering wheel mounted audio controls.



Mobile phone system with Bluetooth®.



180PS

1.6i 16v Turbo – impressive power, with low emissions



High-performance petrol engines.

Petrol engines

	1.4i 16v ECOTEC-4 Twinport	1.6i 16v VVT ECOTEC-4	1.8i 16v VVT ECOTEC-4	1.6i 16v ECOTEC-4 Turbo
Capacity	1364cc	1598cc	1796cc	1598cc
Maximum power	90PS (66kW) @ 5600rpm	115PS (85kW) @ 6000rpm	140PS (103kW) @ 6300rpm	180PS (132kW) @ 5500rpm
Maximum torque	125Nm (92 lb.ft.) @ 4000rpm	155Nm (114 lb.ft.) @ 4000rpm	175Nm (129 lb.ft.)* @ 3800rpm	230Nm (169 lb.ft.) @ 1980-5500rpm
Configuration	4 cylinders, 4 valves per cylinder, double overhead camshafts			
Fuel/induction system	Naturally aspirated with vacuum-controlled. Twinport inlet ports. Multi-point sequential fuel injection.	Naturally aspirated. Variable Valve Timing (VVT). Multi-point sequential fuel injection.	Naturally aspirated. Variable Valve Timing (VVT). Multi-point sequential fuel injection.	Water-cooled turbocharger with intercooler. Multi-point sequential fuel injection.
Service interval	20,000 miles or 1 year (whichever occurs sooner)			
Benefit in kind company car taxation percentage rates – 2008/09 tax year				
Sport Hatch/5-door hatchback/estate				
Expression, Life, Club, Design, Elite, SXi (manual models)**	17/17/17	19/19/19	21/21/22	-
Design with Sports pack, SRi (manual models)**	-	19/19/19	22/22/22	25/25/25

Vauxhall's advanced 1.6i 16v and 1.8i 16v VVT (Variable Valve Timing) engines represent the cutting edge of engine design. By utilising Double Continuous Variable Cam Phasing (DCVCP), our VVT engines develop much of their torque over a broad rpm range, ensuring good performance and flexibility at all engine speeds – reducing the need for frequent gear changes.

Compared to more conventional engines VVT versions develop more power and offer better performance – yet are more economical and boast lower emissions.

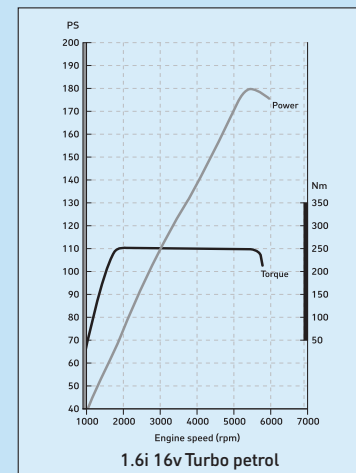
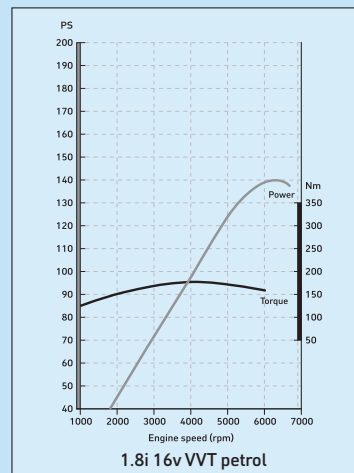

Diesel engines

	1.3CDTi 16v ECOTEC-4 Turbo diesel	1.7CDTi 16v ECOTEC-4 Turbo diesel	1.9CDTi (120PS) ECOTEC-4 Turbo diesel	1.9CDTi 16v (150PS) ECOTEC-4 Turbo diesel
Capacity	1248cc	1686cc	1910cc	1910cc
Maximum power	90PS (66kW) @ 4000rpm	100PS (74kW) @ 4400rpm	120PS (88kW) @ 3500rpm	150PS (110kW) @ 4000rpm
Maximum torque	200Nm (147 lb.ft.) @ 1750-2500rpm	240Nm (177 lb.ft.) @ 2300rpm	280Nm (206 lb.ft.) @ 2000-2750rpm	320Nm (236 lb.ft.) @ 2000-2750rpm
Configuration	4 cylinders, 4 valves per cylinder, double overhead camshafts	4 cylinders, 4 valves per cylinder, double overhead camshafts	4 cylinders, 2 valves per cylinder, single overhead camshaft	4 cylinders, 4 valves per cylinder, double overhead camshafts
Fuel/induction system	Variable geometry turbocharger with intercooler. Common rail fuel injection			
Service interval	20.000 miles or 1 year (whichever occurs sooner)			

Benefit in kind company car taxation percentage rates – 2008/09 tax year

	Sport Hatch/5-door hatchback/estate			
All manual models (where applicable)**	-/18/18	18/18/18	20/20/21	20/20/21

- = This engine/body style/transmission combination is not available.

* = Please note, 1.8i 16v VVT models fitted with optional automatic transmission develop 170Nm (125 lb.ft) of torque.

** = For details of benefit in kind percentage rates relating to Easytronic and automatic models please refer to the Vauxhall Car and Accessory price guide

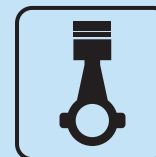

150PS

1.9CDTi 16v –
one of the most
powerful diesel
engines in its class



Common rail turbo diesel engines.

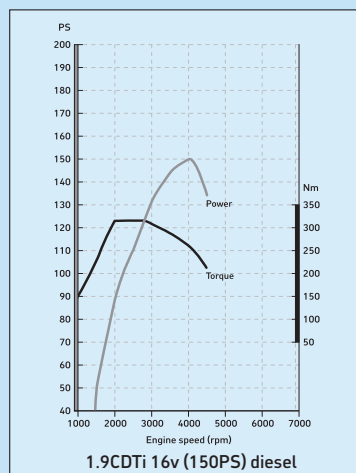
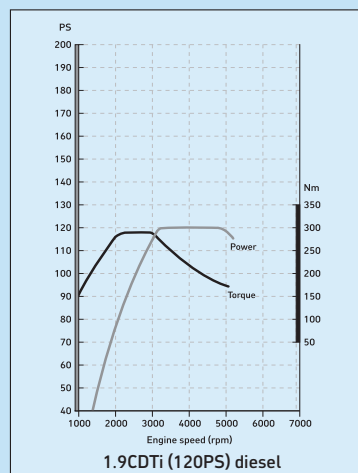



185g/km

The 1.6i 16v Turbo engine combines 180PS with low emissions



68.9mpg

1.3CDTi 16v engine offers great economy and low emissions

Petrol engine performance, fuel economy and emissions

	Wheel size (inches)	Performance (manufacturer's figures)			Fuel economy mpg (litres/100km)			CO ₂ emissions g/km
		Maximum speed (mph)	Acceleration (sec) 0-60mph	30-50mph (4th gear)	Urban driving	Extra-urban driving	Combined figure	
Manual								
1.4i 16v Sport Hatch	16	112	12.7	9.3	35.3 (8.0)	56.5 (5.0)	46.3 (6.1)	146
1.4i 16v 5-dr hatch	15/16	112	12.8	9.4	35.3 (8.0)	56.5 (5.0)	46.3 (6.1)	146
1.4i 16v estate	15/16	112	13.2	9.8	35.3 (8.0)	56.5 (5.0)	46.3 (6.1)	146
1.6i 16v VVT Sport Hatch	16	120	10.8	8.3	32.5 (8.7)	54.3 (5.2)	43.5 (6.5)	155
1.6i 16v VVT Sport Hatch	17	120	10.8	8.3	32.1 (8.8)	53.3 (5.3)	42.8 (6.6)	158
1.6i 16v VVT 5-dr hatch	15/16	119	10.9	8.4	32.5 (8.7)	54.3 (5.2)	43.5 (6.5)	155
1.6i 16v VVT 5-dr hatch	17/18	119	10.9	8.4	32.1 (8.8)	53.3 (5.3)	42.8 (6.6)	158
1.6i 16v VVT estate	15/16	119	11.2	8.7	32.1 (8.8)	53.3 (5.3)	42.8 (6.6)	158
1.6i 16v VVT estate	17/18	119	11.2	8.7	31.7 (8.9)	52.3 (5.4)	42.2 (6.7)	159
1.8i 16v VVT Sport Hatch	16	130	9.4	6.7	29.1 (9.7)	50.4 (5.6)	39.8 (7.1)	169
1.8i 16v VVT Sport Hatch	17/18	130	9.4	6.7	28.8 (9.8)	49.6 (5.7)	39.2 (7.2)	172
1.8i 16v VVT 5-dr hatch	15/16	129	9.5	6.8	29.1 (9.7)	50.4 (5.6)	39.8 (7.1)	169
1.8i 16v VVT 5-dr hatch	17/18	129	9.5	6.8	28.8 (9.8)	49.6 (5.7)	39.2 (7.2)	172
1.8i 16v VVT estate	15/16	129	9.8	7.1	28.8 (9.8)	49.6 (5.7)	39.2 (7.2)	172
1.8i 16v VVT estate	17/18	129	9.8	7.1	28.5 (9.9)	48.7 (5.8)	38.7 (7.3)	174
1.6i 16v Turbo Sport Hatch	17/18	139	7.7	5.3	27.4 (10.3)	45.6 (6.2)	36.7 (7.7)	185
1.6i 16v Turbo 5-dr hatch	17/18	137	7.8	5.3	27.4 (10.3)	45.6 (6.2)	36.7 (7.7)	185
1.6i 16v Turbo estate	17/18	137	7.9	5.5	27.4 (10.3)	45.6 (6.2)	36.7 (7.7)	185
Easytronic								
1.6i 16v VVT Sport Hatch	16	121	11.8	-	33.2 (8.5)	56.5 (5.0)	44.8 (6.3)	151
1.6i 16v VVT 5-dr hatch	15/16	119	11.9	-	33.2 (8.5)	56.5 (5.0)	44.8 (6.3)	151
1.6i 16v VVT estate	15/16	119	12.2	-	32.8 (8.6)	55.4 (5.1)	44.1 (6.4)	153
Automatic								
1.8i 16v VVT Sport Hatch	16	118	10.5	-	27.2 (10.4)	46.3 (6.1)	36.7 (7.7)	184
1.8i 16v VVT Sport Hatch	17/18	118	10.5	-	26.9 (10.5)	45.6 (6.2)	36.2 (7.8)	186
1.8i 16v VVT 5-dr hatch	15/16	117	10.7	-	26.9 (10.5)	45.6 (6.2)	36.2 (7.8)	186
1.8i 16v VVT 5-dr hatch	17/18	117	10.7	-	26.6 (10.6)	44.8 (6.3)	35.8 (7.9)	189
1.8i 16v VVT estate	15/16	117	10.9	-	26.9 (10.5)	45.6 (6.2)	36.2 (7.8)	186
1.8i 16v VVT estate	17/18	117	10.9	-	26.6 (10.6)	44.8 (6.3)	35.8 (7.9)	189

Diesel engine performance, fuel economy and emissions

	Wheel size (inches)	Performance (manufacturer's figures)			Fuel economy mpg (litres/100km)			CO ₂ emissions g/km
		Maximum speed (mph)	Acceleration (sec)		Urban driving	Extra-urban driving	Combined figure	
			0-60mph	30-50mph (4th gear)				
Manual								
1.3CDTi 16v (90PS) 5-dr hatch	15	107	12.8	8.6	44.8 (6.3)	68.9 (4.1)	57.6 (4.9)	130
1.3CDTi 16v (90PS) estate	15	107	13.2	8.9	44.8 (6.3)	68.9 (4.1)	57.6 (4.9)	130
1.7CDTi 16v (100PS) Sport Hatch	16	113	11.4	7.3	44.1 (6.4)	67.3 (4.2)	56.5 (5.0)	135
1.7CDTi 16v (100PS) Sport Hatch	17/18	113	11.4	7.3	43.5 (6.5)	65.7 (4.3)	55.4 (5.1)	138
1.7CDTi 16v (100PS) 5-dr hatch	15	112	11.5	7.4	44.1 (6.4)	67.3 (4.2)	56.5 (5.0)	135
1.7CDTi 16v (100PS) 5-dr hatch	16/17/18	112	11.5	7.4	43.5 (6.5)	65.7 (4.3)	55.4 (5.1)	138
1.7CDTi 16v (100PS) estate	15	112	11.7	7.5	44.1 (6.4)	67.3 (4.2)	56.5 (5.0)	135
1.7CDTi 16v (100PS) estate	16/17/18	112	11.7	7.5	43.5 (6.5)	65.7 (4.3)	55.4 (5.1)	138
1.9CDTi (120PS) Sport Hatch	16/17/18	122	9.7	6.1	39.2 (7.2)	60.1 (4.7)	50.4 (5.6)	149
1.9CDTi (120PS) 5-dr hatch	16/17/18	121	9.8	6.2	39.2 (7.2)	60.1 (4.7)	50.4 (5.6)	149
1.9CDTi (120PS) estate	16/17/18	120	10.0	6.4	38.7 (7.3)	58.9 (4.8)	49.6 (5.7)	151
1.9CDTi 16v (150PS) Sport Hatch	16/17/18	130	8.3	5.9	39.2 (7.2)	60.1 (4.7)	50.4 (5.6)	149
1.9CDTi 16v (150PS) 5-dr hatch	16/17/18	129	8.3	5.9	39.2 (7.2)	60.1 (4.7)	50.4 (5.6)	149
1.9CDTi 16v (150PS) estate	16/17/18	129	8.6	6.1	38.7 (7.3)	58.9 (4.8)	49.6 (5.7)	151
Automatic								
1.9CDTi (120PS) Sport Hatch	16/17/18	118	10.7	-	29.4 (9.6)	53.3 (5.3)	40.9 (6.9)	186
1.9CDTi (120PS) 5-dr hatch	16/17/18	117	10.8	-	29.1 (9.7)	52.3 (5.4)	40.4 (7.0)	189
1.9CDTi (120PS) estate	16/17/18	116	10.9	-	29.1 (9.7)	52.3 (5.4)	40.4 (7.0)	189

The fuel consumption figures shown comply with EC directive 1999/100 to provide a realistic indication of fuel consumption by taking into account everyday driving conditions, such as cold starts, acceleration, braking and even differences in the weight of models with the same engine. **Important:** the results given relate to the particular car tested; inevitably there are differences between individual cars of the same model. In addition, some cars may incorporate particular modifications. Driving style, road and traffic conditions, vehicle mileage and standard of maintenance may also affect fuel consumption; therefore the results do not express or imply any guarantee of the fuel consumption attainable.

Vauxhall supporting



Smarter driving tips

- Drive at an appropriate speed: – Staying within the speed limit increases driver safety, reduces CO₂ emissions and saves fuel. At 70mph you could be using up to 9% more fuel than at 60mph and up to 15% more fuel than at 50mph
- Drive smoothly at all times: – Anticipate the ebb and flow of the traffic to avoid harsh acceleration and braking
- Reduce your revs: – Change gear earlier to help reduce fuel consumption – try 2500 rpm with petrol engines and 2000 rpm with diesel
- Idling is wasting fuel: – If you're likely to be at a standstill for more than three minutes, switch off the engine to save fuel
- Regularly check your tyre pressures: – Under inflated tyres increase CO₂ emissions whilst over inflated tyres can be unsafe. Always check your handbook for the correct tyre pressure. This will also help to increase the life of your tyres
- Remove unnecessary items from the car: – Extra weight increases the engine's workload, whilst roof racks and bike carriers increase wind resistance. All burn more fuel and increase CO₂ emissions

Exterior dimensions millimetres (inches)

Dimensions

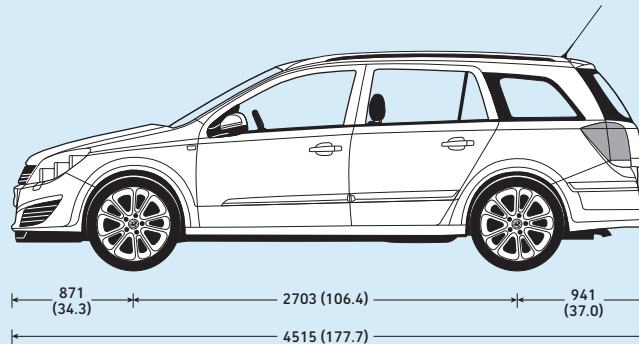
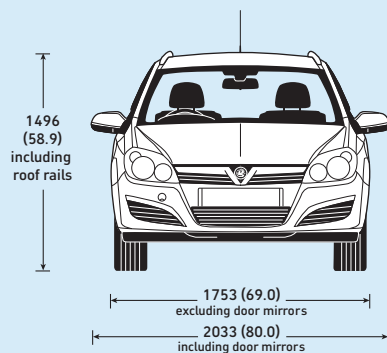
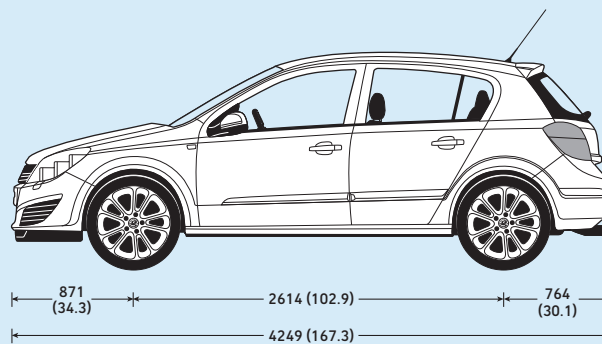
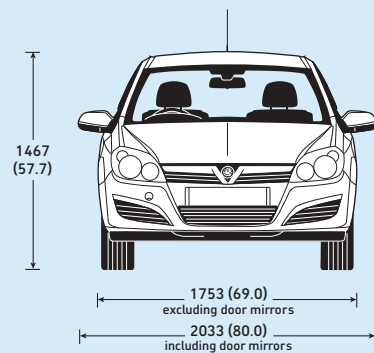
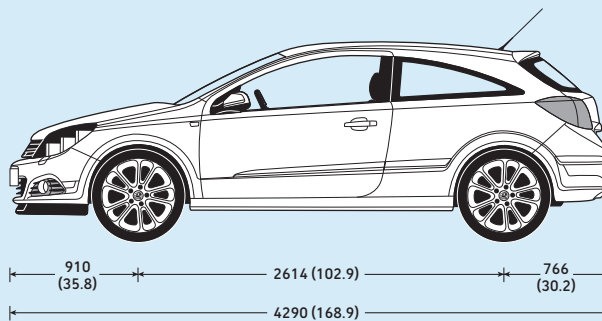
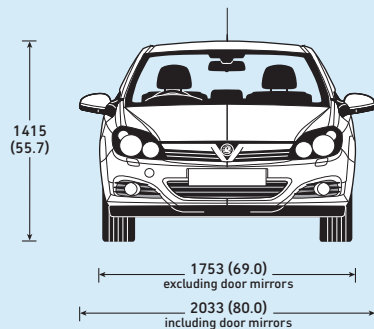

Interior dimensions see table below

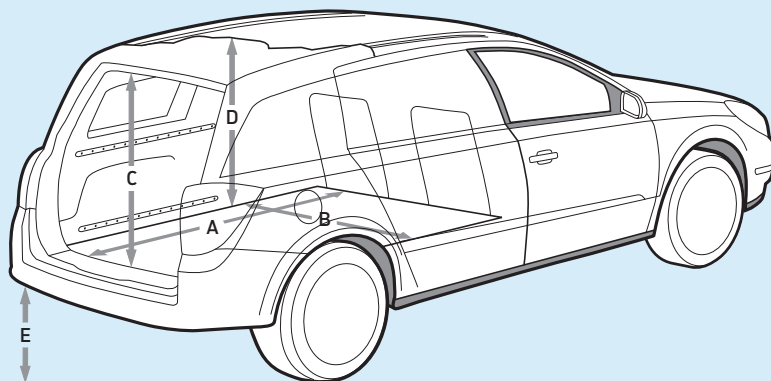

1550 litres
Maximum luggage
capacity

Estate loadspace dimensions millimetres (inches)

Maximum load floor length (rear seats up)	1085 (42.7)
Maximum load floor length (rear seat back down only) (A)	1819 (71.6)
Maximum load floor length (rear seat back down and cushion folded) (A)	1699 (66.9)
Maximum luggage area height (D)	862 (33.9)
Tailgate aperture height (C)	766 (30.1)
Tailgate aperture width	1058 (41.6)
Rear floor width (B)	1088 (42.8)
Loading height from ground level (E)	591 (23.3)

Luggage capacities* litres (cu. ft.)

	Sport Hatch	5-door hatch	Estate
Rear seats up – to top of rear seat back	312 (11.0)	350 (12.4)	470 (16.6)
Rear seats folded – to roof	1070 (37.8)	1265 (44.7)	1550 (54.7)

* = Measured using the ECIE method.



4-/5-/6-speed

Automatic and Easytronic transmission options available



MacPherson strut front suspension.



Lightweight torsion beam rear axle.

Vauxhall Assistance and warranties*

- A one-year unlimited mileage manufacturer's warranty
- Second and third year no-fee customer option warranty up to 60,000 miles (from first registration)
- Vauxhall Assistance for 12 months from first registration
- Six years' body panel anti-perforation warranty

* = Warranty is only available on vehicles sourced from Vauxhall Motors Ltd. Terms and conditions apply – please see your Vauxhall retailer for details.

Optional transmissions

Five-speed Easytronic transmission – 1.6i 16v VVT models:

Easytronic is a five-speed manual gearbox with a fully automatic mode. In manual mode you simply push the lever forward or back to shift gears up or down, while the fascia display tells you what gear you're in. Switch to fully automatic mode and you'll have many of the features of a regular automatic, including kickdown. Since there's no clutch pedal, Easytronic is ideal for effortless town driving.

Four-speed automatic transmission – 1.8i 16v VVT models:

Electronically controlled with an adaptive driving programme, which tailors its gearchanges to match your driving conditions.

Six-speed automatic transmission with Active Select function – 1.9CDTi (120PS) models:

The electronically controlled adaptive driving function can tailor gearchanges to match your driving style, while the winter mode selects a higher than normal gear to reduce the possibility of wheelspin in

icy conditions. The Active Select manual mode allows the gearlever to be used like a manual gearbox – you simply push the lever forward or back to change up or down the gears.

Steering

- Electro-hydraulic power-assisted steering
- Turning circle (kerb-to-kerb):
Sport Hatch models – 10.84m (35.6ft)
5-door hatchback models – 10.85m (35.6ft)
Estate models – 11.17m (36.6ft)

Suspension

Front: Independent. Lightweight MacPherson struts with gas-pressure dampers and coil springs. Anti-roll bar.

Rear: Lightweight torsion beam rear axle with one-piece, hollow cast trailing arms. Built-in anti-roll bar. Progressive-rate double conical mini-block springs and gas-pressure dampers.

- Design 1.6i 16v Turbo and 1.9CDTi 16v (150PS)/SRi/All Sport Hatch models – uprated springs and dampers with lower ride height
- Design/SRi – Interactive Driving System with Continuous Damping Control, optional at extra cost

Brakes

- Anti-lock Braking System (ABS)
 - Dual circuit, diagonally split braking system
- 1.4i 16v Expression/Life 5-door hatch only**

Front ventilated discs: 280mm diameter
Rear drums: 230mm diameter

1.4i 16v (excl. Expression/Life 5-door hatch)

Front ventilated discs: 280mm diameter
Rear discs: 264mm diameter

1.6i 16v VVT

Front ventilated discs: 280mm diameter
Rear discs: 264mm diameter

1.8i 16v VVT

Front ventilated discs: 280mm diameter
Rear discs: 264mm diameter

1.6i 16v Turbo

Front ventilated discs: 308mm diameter
Rear discs: 264mm diameter

1.3CDTi 16v (90PS)

Front ventilated discs: 280mm diameter
Rear discs: 264mm diameter

1.7CDTi 16v (100PS)

Front ventilated discs: 280mm diameter
Rear discs: 264mm diameter

1.9CDTi (120/150PS)

Front ventilated discs: 308mm diameter
Rear discs: 264mm diameter

Body

- Aerodynamic drag co-efficients:
Sport Hatch – Cd 0.32
5-door hatch – Cd 0.32
Estate – Cd 0.32

Fuel tank capacity

All models – 52 litres (11.4 gallons).

Weights and towing data kg

	Kerbweight (Gross vehicle weight)			Maximum towing weights Trailer with brakes (without brakes)		
	Sport Hatch	5-door hatch	estate	Sport Hatch	5-door hatch	estate
1.4i 16v Expression/Life	-	1165 (1715)	1203 (1810)	-	1000 (615)	900 (640)
1.4i 16v Club	-	1188 (1735)	1226 (1830)	-	1000 (615)	900 (640)
1.4i 16v SXi	1190 (1715)	1210 (1735)	1248 (1830)	1000 (605)	1000 (615)	900 (640)
1.6i 16v VVT Life	-	1195 (1745)	1240 (1840)	-	1200 (635)	1100 (660)
1.6i 16v VVT Club	-	1218 (1765)	1263 (1860)	-	1200 (635)	1100 (660)
1.6i 16v VVT Design	1207 (1745)	1227 (1765)	1272 (1860)	1200 (635)	1200 (635)	1100 (660)
1.6i 16v VVT Elite	-	1237 (1765)	-	-	1200 (635)	-
1.6i 16v VVT SXi	1220 (1745)	1240 (1765)	1285 (1860)	1200 (635)	1200 (635)	1100 (660)
1.8i 16v VVT Life	-	1203 (1760)**	1231 (1850)**	-	1300 (630)	1300 (660)
1.8i 16v VVT Club	-	1226 (1780)**	1254 (1870)**	-	1300 (630)	1300 (660)
1.8i 16v VVT Design	1222 (1760)*	1235 (1780)**	1263 (1870)**	1300 (630)	1300 (630)	1300 (660)
1.8i 16v VVT Elite	-	1246 (1780)**	-	-	1300 (630)	-
1.8i 16v VVT SRi	1236 (1760)*	1248 (1780)**	1276 (1870)**	1300 (630)	1300 (630)	1300 (660)
1.6i 16v Turbo Design	1272 (1810)	1292 (1830)	1332 (1920)	1500 (675)	1500 (675)	1400 (690)
1.6i 16v Turbo SRi	1285 (1810)	1305 (1830)	1345 (1920)	1500 (675)	1500 (675)	1400 (690)
1.3CDTi 16v (90PS) Life	-	1265 (1815)	1305 (1905)	-	1300 (650)	1300 (690)
1.3CDTi 16v (90PS) Club	-	1283 (1830)	1323 (1920)	-	1300 (650)	1300 (690)
1.7CDTi 16v (100PS) Life	-	1290 (1840)	1320 (1935)	-	1400 (680)	1400 (690)
1.7CDTi 16v (100PS) Club	-	1308 (1855)	1338 (1950)	-	1400 (680)	1400 (690)
1.7CDTi 16v (100PS) Design	1297 (1835)	1317 (1855)	1347 (1950)	1400 (670)	1400 (680)	1400 (690)
1.7CDTi 16v (100PS) Elite	-	1328 (1855)	-	-	1400 (680)	-
1.7CDTi 16v (100PS) SXi/SRi	1310 (1835)	1330 (1855)	1360 (1950)	1400 (670)	1400 (680)	1400 (690)
1.9CDTi (120PS) Design	1342 (1860)†	1345 (1885)†	1402 (1975)†	1500 (680)	1500 (680)	1400 (715)
1.9CDTi (120PS) Elite	-	1356 (1885)†	-	-	1500 (680)	-
1.9CDTi (120PS) SXi/SRi	1343 (1860)†	1346 (1885)†	1403 (1975)†	1500 (680)	1500 (680)	1400 (715)
1.9CDTi 16v (150PS) Design	1342 (1880)	1345 (1900)	1402 (1990)	1500 (690)	1500 (690)	1400 (720)
1.9CDTi 16v (150PS) SRi	1343 (1880)	1346 (1900)	1403 (1990)	1500 (690)	1500 (690)	1400 (720)

* = Please note: On 1.8i 16v VVT Sport Hatch models fitted with automatic transmissions the kerbweight increases by 13kg and the gross vehicle weight increases by 25kg.

** = Please note: On 1.8i 16v VVT 5-door hatchback and estate models fitted with automatic transmissions the kerbweight and gross vehicle weight increase by 25kg.

† = Please note: On 1.9CDTi (120PS) models fitted with automatic transmissions the kerbweight and gross vehicle weight increase by 30kg.

Gross vehicle weight is the total permissible weight of the vehicle including passengers and their luggage. To determine total carrying capacity, deduct kerbweight from gross vehicle weight. Note that the figure obtained will include the weight of the driver, passengers and any optional equipment or accessories. The **maximum roof rack loading** should not exceed 75kg. The **maximum towing weights** are based on the ability of the car, with two occupants of 75kg each, to restart on a 12% gradient, which is approximately 1 in 8.3 at sea level. At altitudes above 1500 metres, the engine output may drop with a corresponding reduction in towing capability. Any extra weight, such as luggage or additional passengers, should be deducted from the maximum towing weight. With a trailer fully loaded, **maximum noseweight** should not exceed 75kg. Always fit Vauxhall towing attachments and accessories available from your Vauxhall retailer. They are designed specifically for Vauxhall models and carry a 12-month guarantee.

Features explained

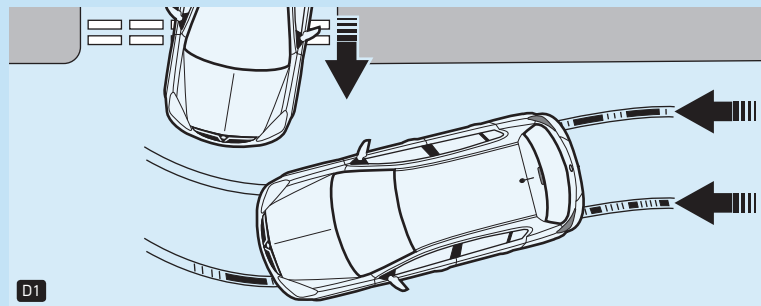

Anti-lock Braking System (ABS) with Cornering Brake Control (CBC)

D1. Cornering brake control makes the car easier to control in extreme situations, particularly when braking sharply on a bend. It is particularly effective when carrying out emergency procedures, such as avoiding a child's ball that's rolled out from the kerb. The system works by sensing the different rotational speeds of the individual road wheels and co-ordinating the level of braking pressure applied to each wheel. CBC is an integral part of Astra's comprehensive ABS.

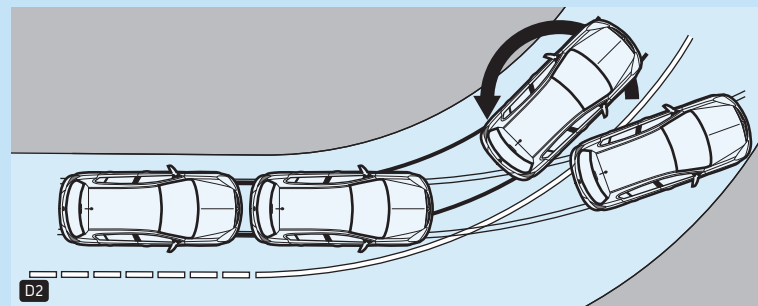

Electronic Stability Programme-plus (ESP-plus)

D2. ESP-plus provides enhanced yaw compensation during understeer or oversteer. It works by monitoring the front and rear of the car and comparing their respective directions of travel with the input through the steering wheel. If the vehicle starts to slide, ESP-plus applies corrective braking to the appropriate wheel, or wheels, compensating for the slide and helping you regain control more rapidly. ESP-plus offers additional safety in the form of two-way traction control, which helps prevent the driving wheels from spinning, under acceleration, on slippery surfaces.

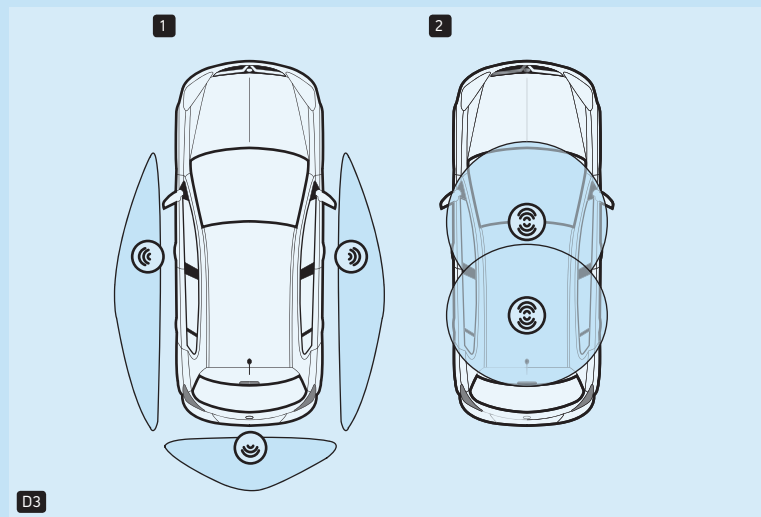

Keyless entry and start

D3. Available as an option, the keyless entry and start system means that the driver need never remove their key fob from their pocket. When approaching the car, sensors in the front door handles and rear bumper **1** detect the driver's proximity and automatically unlock the doors or boot when the handle is pulled.

When in the car, two internal sensors **2** activate the ignition and release the electronic steering lock, enabling the driver to start or stop the engine by pressing the dashboard-mounted Start/Stop button. As an added safety feature, the engine will only start if the driver presses the foot brake while pushing the Start/Stop button.

Upon leaving the vehicle, the driver can lock it by either pressing a button on the key fob like a conventional system, or by simply touching one of the sensors on the external handles of the front doors.

Additionally the system offers excellent theft protection by its use of sophisticated cryptographic algorithms, while a back-up key is also included for emergency use.

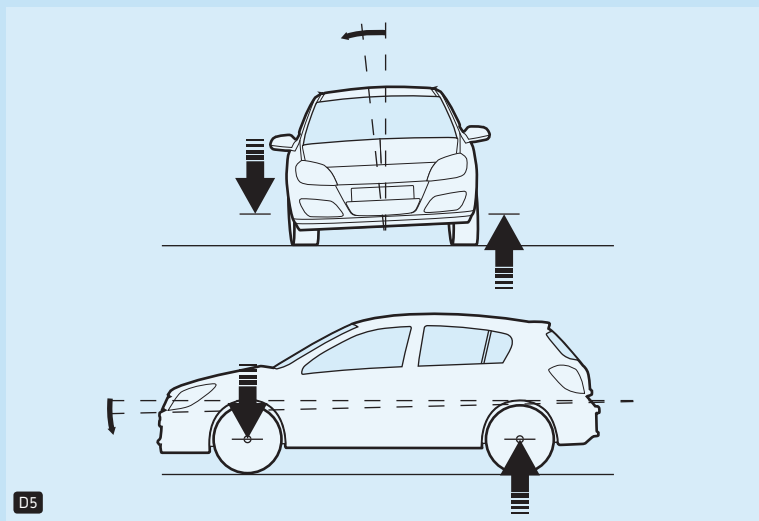

Sport switch

D4. The Sport switch, standard on Design 1.6i 16v Turbo and 1.9CDTi 16v (150PS) and all SRi models, improves the responses of both the steering and throttle, giving the driver crisper initial acceleration and sharper, more direct turn-in when cornering. On vehicles fitted with automatic transmission, the Sport switch also controls the transmission Sport mode.



IDS-plus with Continuous Damping Control (CDC)

D5. The Interactive Driving System (IDS-plus) chassis – available on SRi and Design models – offers the Astra driver an even more sporting driving experience, thanks mainly to the electronic control of the suspension. Pressing the Sport switch activates the CDC function – CDC monitors the roll, pitch and yaw of the car, and changes the rate of damping on each wheel to optimise the handling, selectively stiffening the suspension. This means the vehicle will exhibit a reduced rate of roll and pitch, making it more responsive during direction changes and more settled during the braking/turn-in/acceleration transition when cornering. CDC is a major breakthrough in the Astra segment.

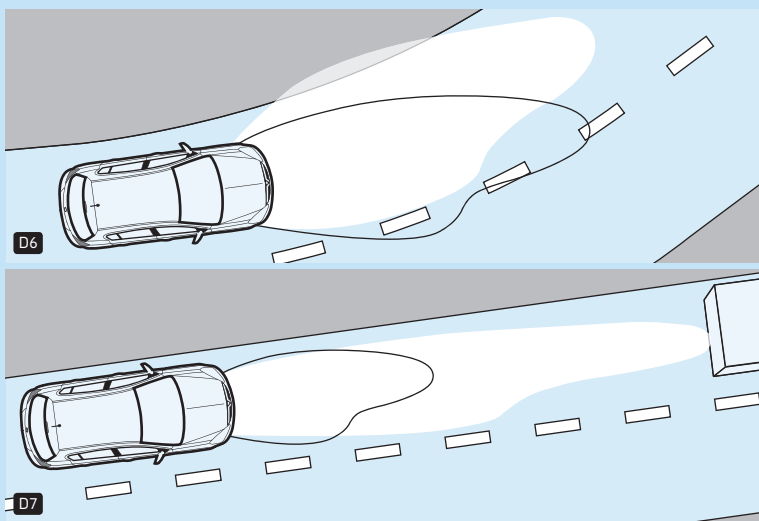

Bi-xenon Adaptive Forward Lighting (AFL)

Adaptive Forward Lighting is a sophisticated new lighting system that allows drivers to see around corners. AFL utilises powerful bi-xenon headlights – which offer up to three times more light output than conventional halogen headlights – to enable the full benefit of the system's advantages to be appreciated. While standard xenon headlights provide only dipped beam lighting (main beam illumination still uses conventional halogen lights), bi-xenon units provide both dipped and main beam from a single lighting unit. The package is completed by high-pressure headlight washers and dynamic beam levelling.

Curving Light

D6. Controlled by a combination of steering wheel movement and sensors for the vehicle's speed and yaw angle, the Curving Light function allows the headlight beam to move up to 15 degrees left or right of the straight ahead position. This ensures the light is always following the trajectory plotted by the front wheels, rather than simply pointing straight ahead.

Motorway Light

D7. At speeds above 65mph, AFL raises the dipped headlight beam to extend the range of vision for increased safety at higher speed. The beam automatically returns to its normal position when the car falls below that speed.

Trust Vauxhall

Protecting the environment

Vauxhall's commitment to the environment is demonstrated by our products' many environmental awards, won both through the use of more recycled materials and by becoming cleaner and more efficient. For information on Vauxhall's efforts to achieve an environmentally sustainable future, see www.vauxhall.co.uk/recycling

Fleet Customer Services

Our dedicated support services for fleet managers includes factory demonstrators, a three-day test drive programme and information on whole life costs, company car taxation and finance. For further information please call **0870 010 0651**.

Buying your car

GMAC offers one of the most comprehensive and competitive ranges of financing plans in the UK. Contact your local Vauxhall retailer for details or call the GMAC customer service centre on **0845 712 3444**.



When you have finished with this brochure please recycle it

The GM Platinum Card is issued by HFC Bank Limited and is available to persons aged 18 years or over and resident in the UK (or 21 and over in the Channel Islands) and is subject to status and conditions. Written quotations are available upon request from The GM Platinum Card, PO Box 3615, Birmingham B3 2RJ. The typical APR quoted is the rate for new customers. Rebate Points are earned on purchases using The GM Platinum Card. Rebate Points are not earned on Balance Transfers or Cash Advances. You earn money off a new Vauxhall/Saab by accumulating Rebate Points under the Rebate Points Programme. General Motors UK Limited is solely responsible for the operation of the Rebate Points Programme, which is subject to the Rebate Points Programme Rules. *You can redeem up to 2500 Rebate Points subject to the Model Line Maximum which will vary in amount in relation to different Vauxhall/Saab vehicle model lines and unlimited Partner Points. Rebate Points and unlimited Partner Points are redeemable as discounts on a new Vauxhall/Saab vehicle and must be redeemed four years from the issue date. Rebate Points may not be redeemed by Motability Contract Hire customers. The GM Card is a trading name and style of both HFC Bank Limited and General Motors UK Limited. HFC Bank registered in England No. 1117305. Registered Office: North Street, Winkfield, Windsor, Berkshire SL4 4TD is authorised and regulated by the Financial Services Authority. **Member HSBC Group** HFC Bank Limited is not a member of the same group of companies as General Motors UK Limited, Saab GB Limited or GMAC UK plc. General Motors UK Limited, Registered Office: Griffin House, Osborne Road, Luton, Bedfordshire LU1 3YT. Registered in England number 135767. - CN6/0987.

Every effort has been made to ensure that the contents of this publication were accurate and up-to-date at the time of going to press (July 2008). Vauxhall vehicles are equipped with components manufactured by various General Motors operating units and outside suppliers. The Company reserves the right to alter specifications and vehicle products from sale without notice. Any such alterations will be notified to Vauxhall retailers at the earliest opportunity, please consult your local retailer for the latest information. The specifications detailed within this brochure are not necessarily applicable to alternative models such as Special Editions. Details of any such models will be contained in specific literature or found on the Vauxhall website. Please note that Vauxhall retailers are not the agents of General Motors UK Limited and are not authorised to bind the Company by any specific or implied undertaking or representation. It is advisable to ensure that your motor insurance policy provides adequate cover for additional fitted options and accessories. As part of Vauxhall's policy of environmental care, this brochure is printed on paper manufactured using Elemental Chlorine Free pulps from specially farmed, sustainable timber resources. All rights reserved. No part of this publication may be reproduced in any form or by any means, without the prior written permission of General Motors UK Limited.

VM0807907 Published August 2008 (BMB/Graymatter) General Motors UK Limited, Luton LU1 3YT

Sureguard protection

Sureguard Assistance offers the benefits of Vauxhall Assistance for three years from first registration, while Sureguard Warranty also provides a parts and labour warranty for high-mileage or long-term owners. For details contact your local Vauxhall retailer or call **0870 752 7020**.

Specialist Mobility advice

Motability accredited Vauxhall retailers can provide special mobility help and advice. Blue badge holders are entitled to very favourable discounts on new vehicles. Contact your local Motability accredited Vauxhall retailer or **Freefone 0800 731 5267**.

Servicing and maintenance

The best way to maximise the performance and reliability of your Vauxhall is to have all routine servicing and maintenance carried out at one of around 400 Vauxhall retailers. To find your nearest retailer call **0845 600 1500**.

In the event of an accident...

Vauxhall Accident Support helps keep you mobile following an accident. Benefits include scene-of-accident advice, message service, assistance with claims and vehicle recovery. For further details call **0800 010 304**.

Vauxhall Insurance

Available for new and used Vauxhalls, a Vauxhall Insurance policy offers a unique package designed specifically for Vauxhall drivers. For a highly competitive quotation, call **0870 024 0240** or visit our website at www.vauxhall.co.uk

For more information...

For a brochure on any Vauxhall model (up to a maximum of three per caller) or location of your nearest Vauxhall retailer please **Lo-call 0845 600 1500**.

Alternatively, details can be found on our website at www.vauxhall.co.uk



- Save up to **£1500*** on a new Vauxhall with The GM Card
- **100 Rebate Points worth £100** when you use The GM Card for the first time
- Rebate Point saving is on top of any discount or offer negotiated with the Retailer
- Earn **3 Rebate Points (£3)** for every **£100** you spend

Typical 14.9% APR variable

To apply call **0845 746 2777** or visit www.gmcard.co.uk.



VAUXHALL