

ASTRA GTC PRICE/SPECIFICATION GUIDE

1 April 2014



Proud Sponsor of Home Nations Football



ASTRA GTC CUSTOMER OFFERS

At Vauxhall we know that customers appreciate flexibility. Not only do we have an extensive range of Astra GTC models to choose from, on most of them you can also take advantage of our Flexible Finance offer. Here's how it works:

0% APR
REPRESENTATIVE
FLEXIBLE FINANCE



- 1 CHOOSE YOUR CAR**
Select a new vehicle.
- 2 CHOOSE YOUR DEPOSIT**
Any deposit. We'll give you up to £1500 to get you started.*
- 3 CHOOSE YOUR TERM**
From 24 to 60 months.
- + VAUXHALL LIFETIME WARRANTY****
Lifetime 100,000 mile warranty.
First registered owner.

For even more great deals contact your local retailer or call 0845 600 1500 or visit www.vauxhall.co.uk/offers

TERMS AND CONDITIONS: Available on selected models only, at participating retailers. Finance subject to status. Terms and conditions apply. Applicants must be 18 or over. Finance supplied by Vauxhall Finance, PO Box 6666, Cardiff, CF15 7YT. * Vauxhall Deposit Contributions vary. 24-60 month term. Offer will apply to private individuals, Vauxhall Partners and small businesses 1-24 (purchase only, excluding B2B supported units). All other customers are excluded. Refer to www.vauxhall.co.uk/offers or contact your local Vauxhall retailer for details. **Vauxhall Lifetime Warranty covers lifetime ownership of first registered keeper, 100,000 mile limit. Terms and Conditions apply.

ASTRA GTC COMPANY CAR DRIVER/FLEET INFORMATION

COMPANY CAR DRIVER FREE* 3 DAY TEST DRIVE

Our free* 3 Day Test Drive programme is open to all Company Car Drivers which allows you to choose any model in the current Vauxhall line-up (excluding Ampera, all VXR models and Commercial Vehicles), with full insurance cover provided, to give you a meaningful length of time to make an informed decision about your next company car.

Click below to book your free* test drive
www.vauxhall3dtd.co.uk
or call **0870 240 4848****

*The free 3 Day Test Drive programme is open to Company Car Drivers and excludes fuel and lubricants; congestion charges; parking and speeding fines and the £250 insurance excess (if applicable). It features a wide selection of models from the Vauxhall range (excluding Ampera, all VXR models and Commercial Vehicles and subject to availability). Drivers must be aged 25 years or over, have held a full driving licence for at least a year and hold a major credit card. You will need to have your driving licence (and proof of identity (i.e. passport) where the driving licence is not a photocard licence) when your car is delivered. While every effort will be made to ensure that at least 3 days are provided for the test drive, this cannot always be guaranteed due to delivery and collection dates and timings. Available for UK Mainland only. Terms and conditions apply. **Telephone lines open Monday-Friday 9.00am to 5.00pm excluding Bank Holidays. Calls may be recorded or monitored for quality and/or training purposes.



FLEET TOOLBOX

Discover the facts in our online Toolbox for both Company Car Drivers and Fleet Decision Makers. The Fleet Toolbox has a host of useful calculators, comparators, interactive listings and information. Visit the Fleet Toolbox by going to www.vauxhall-toolbox.co.uk



ROADTRIP APP

The Vauxhall RoadTrip App is a free app that calculates and logs your mileage expenses for any UK business trips and generates reports to help you complete your mileage claims. Available for both iPhone and Android, visit www.vauxhall-toolbox.co.uk or visit the iPhone or Android stores and search for Vauxhall RoadTrip to download it to your smartphone or tablet.



BENEFIT IN KIND COMPANY CAR TAXATION†

The car benefit charge will be the car's list price (including VAT, options and accessories fitted, delivery to retailer and number plates, but excluding Vehicle Excise Duty and new vehicle first registration fee) multiplied by the percentage charge for the CO₂ emissions band in which the car falls (see table opposite). Multiply this figure by your personal income tax rate (20% for Basic Rate, 40% for Higher Rate) to calculate your annual benefit in kind tax liability.

Example:

Astra GTC Sport 1.7CDTi 16v (110PS) ecoFLEX Start/Stop (CO₂ emissions 109g/km)

On-the-road RRP £21845.00

Deduct: Vehicle Excise Duty (£0.00)

New vehicle first registration fee (£55.00)

Effective list price £21790.00

Add: Optional two-coat metallic paint £525.00

List price for tax purposes (P11D value) £22315.00

Car benefit charge
2014-15 tax year (17%) £3793.00

Benefit in kind tax liability (2014-15 tax year)

Basic Rate (20%) tax payer £758.00

Higher Rate (40%) tax payer £1517.00

† = Please note this Price Guide provides taxation information as a guide only. Vauxhall does not provide taxation guidance. Drivers should always take professional advice on their own tax position.

CO ₂ emissions in grams per kilometre	Percentage of car's price to be taxed	
	Petrol 2014-15 tax year	Diesel 2014-15 tax year
up to 75	5	8
76-94	11	14
95-99	12	15
100-104	13	16
105-109	14	17
110-114	15	18
115-119	16	19
120-124	17	20
125-129	18	21
130-134	19	22
135-139	20	23
140-144	21	24
145-149	22	25
150-154	23	26
155-159	24	27
160-164	25	28
165-169	26	29
170-174	27	30
175-179	28	31
180-184	29	32
185-189	30	33
190-194	31	34
195-199	32	35
200-204	33	35
205-209	34	35
210 and above	35	35

To calculate your own personal liability a car tax calculator is available at:
<https://www.vauxhallfleet.co.uk/toolbox>

CONTACT VAUXHALL FLEET

Please contact one of our dedicated sales teams who will be happy to help with your particular enquiry.

Company Car Drivers

Call: **0845 111 2020**

Email: company-car@vauxhallinfo.co.uk

Telephone lines are open

– Monday to Friday 8.00am-9.00pm

– Saturday and Sunday 9.00am-6.00pm

Fleet Decision Makers

Depending on the size of your fleet of vehicles, we have a dedicated team to handle your enquiries. The lines are open Monday to Friday excluding Bank Holidays.

1-24 vehicles

Call: **0845 076 2254** (8.30am-5.00pm)

Email: b2bsales@vauxhall.co.uk

25+ vehicles

Call: **0870 010 0651** (8.30am-5.00pm)

Email: vauxhallfleet@vauxhall.co.uk

Special Vehicles (Police, Fire and Ambulance)

Call: **01525 408 320** (8.30am-5.00pm)

Email: vauxhallspecialvehicles@vauxhall.co.uk

ASTRA GTC RANGE HIGHLIGHTS

SPORT

£18,995-£23,435

- Electronic Stability Programme (ESP)
- Driver's and front passenger's airbags
- Front seat side-impact airbags
- Full-size curtain airbags
- Active-safety front seat head restraints
- Daytime running lights
- 18-inch 7-spoke alloy wheels
- Air conditioning
- CD/MP3 CD player with stereo radio (CD 400+)
- Aux-in socket
- Digital radio
- Shark fin aerial
- USB connection with iPod control
- Electrically operated front windows
- Dual-tone horn
- Cruise control
- Remote control central deadlocking
- Three-spoke leather-covered steering wheel
- Steering column adjustable for reach and rake
- Steering wheel mounted audio controls
- Illuminated vanity mirrors
- Driver's and front passenger's seat height adjuster
- 60/40 split-folding rear seat back
- Front seat back storage pockets
- Remote control alarm system (optional at extra cost on 1.4i 16v VVT Turbo (120PS))

LIMITED EDITION

£19,995-£24,135

Features over Sport

- 20-inch bi-colour alloy wheels
- Sports style front and rear bumper, body-colour front upper grille, side sills, rear lower skirt and rear roof spoiler
- Bluetooth® connectivity
- Dark-tinted rear windows

SRI

£20,710-£24,660

Features over Sport

- Sports front seats
- Rain-sensitive windscreen wipers
- Automatic lighting control with tunnel detection and digital high beam assist
- Electro-chromatic anti-dazzle rear-view mirror
- Front fog lights
- Multi-function trip computer
- Front centre armrest with storage facility
- Chrome-effect exterior side window surround
- Ambient lighting in doors
- Door sill covers
- Dark-tinted rear windows
- Remote control alarm system

BiTurbo

£24,175

Features over SRI

- Lowered and uprated suspension
- Three-spoke chrome-bezelled flat-bottom leather-covered steering wheel
- Electric parking brake
- Hill start assist
- Sports pedals
- Sports style front bumper, body-colour front upper grille, side sills, rear lower skirt and rear roof spoiler
- Twin visible stainless steel exhaust tailpipes

ASTRA GTC PRICES

Model 3-door hatchback	Price (£)	VAT (£)	Total (£)	On-the-road RRP (£)	CO ₂ (g/km)
SPORT					
1.4i 16v VVT Turbo (120PS) S/S	15091.67	3018.33	18110.00	18995.00	139
1.4i 16v VVT Turbo (140PS) S/S	15833.33	3166.67	19000.00	19885.00	139
1.4i 16v VVT Turbo (140PS) auto	16916.67	3383.33	20300.00	21235.00	154
1.6i 16v Direct Injection Turbo (200PS) S/S	16929.17	3385.83	20315.00	21250.00	154
<i>Diesel</i>					
1.7CDTi 16v (110PS) ecoFLEX S/S	16745.83	3349.17	20095.00	20850.00	114
1.7CDTi 16v (110PS) ecoFLEX S/S (109g/km)	17575.00	3515.00	21090.00	21845.00	109
1.7CDTi 16v (130PS) ecoFLEX S/S	17245.83	3449.17	20695.00	21450.00	114
1.7CDTi 16v (130PS) ecoFLEX S/S (109g/km)	18075.00	3615.00	21690.00	22445.00	109
2.0CDTi 16v (165PS) S/S	17666.67	3533.33	21200.00	21955.00	127
2.0CDTi 16v (165PS) auto	18779.17	3755.83	22535.00	23435.00	149
LIMITED EDITION					
1.4i 16v VVT Turbo (120PS) S/S	15912.50	3182.50	19095.00	19995.00	142
1.4i 16v VVT Turbo (140PS) S/S	16404.17	3280.83	19685.00	20585.00	142
1.4i 16v VVT Turbo (140PS) auto	17500.00	3500.00	21000.00	21935.00	156
1.6i 16v Direct Injection Turbo (200PS) S/S	17512.50	3502.50	21015.00	21950.00	156
<i>Diesel</i>					
1.7CDTi 16v (110PS) ecoFLEX S/S	17329.17	3465.83	20795.00	21550.00	116
1.7CDTi 16v (130PS) ecoFLEX S/S	17829.17	3565.83	21395.00	22150.00	116
2.0CDTi 16v (165PS) S/S	18250.00	3650.00	21900.00	22655.00	129
2.0CDTi 16v (165PS) auto	19362.50	3872.50	23235.00	24135.00	150
SRI					
1.4i 16v VVT Turbo (120PS) S/S	16520.83	3304.17	19825.00	20710.00	139
1.4i 16v VVT Turbo (140PS) S/S	16854.17	3370.83	20225.00	21110.00	139
1.4i 16v VVT Turbo (140PS) auto	17937.50	3587.50	21525.00	22460.00	154
1.6i 16v Direct Injection Turbo (200PS) S/S	17950.00	3590.00	21540.00	22475.00	154
<i>Diesel</i>					
1.7CDTi 16v (110PS) ecoFLEX S/S	17770.83	3554.17	21325.00	22080.00	114
1.7CDTi 16v (110PS) ecoFLEX S/S (109g/km)	18600.00	3720.00	22320.00	23075.00	109
1.7CDTi 16v (130PS) ecoFLEX S/S	18270.83	3654.17	21925.00	22680.00	114
1.7CDTi 16v (130PS) ecoFLEX S/S (109g/km)	19100.00	3820.00	22920.00	23675.00	109
2.0CDTi 16v (165PS) S/S	18687.50	3737.50	22425.00	23180.00	127
2.0CDTi 16v (165PS) auto	19800.00	3960.00	23760.00	24660.00	149
BiTurbo					
2.0CDTi 16v (195PS) S/S	19516.67	3903.33	23420.00	24175.00	129

Please note: On-the-road recommended retail prices (RRP) include number plates and delivery to retailer of £700.00 (inc. £116.67 VAT), 12 months' Vehicle Excise Duty and new vehicle first registration fee of £55.00. Excludes fuel and insurance.
S/S = Start/Stop.

ASTRA GTC FEATURES/OPTIONS

SAFETY

Standard features

Airbags: • Driver's airbag • Front passenger's airbag • Front seat side-impact airbags • Full-size curtain airbags • Deactivation switch for front passenger's front and side-impact airbags – Ensures front passenger airbags do not inflate when a child seat is fitted to the front passenger's seat

Seating: • Active-safety front seat head restraints • Height-adjustable front and outer rear seat head restraints • Five lap and diagonal inertia-reel seatbelts • Front body-lock diagonal seatbelt pretensioner system – Tightens the seatbelt during the early stages of a frontal impact • Drivers and front passenger's lap belt pretensioner system • Front seatbelt force limiters – Reduces potential upper body injuries during a frontal impact • Anti-submarining ramps in front seats – Help prevent occupants sliding underneath the lap belt during a collision • ISOFIX child seat restraint system for outer rear seats incorporating top tether (does not include child seat) – Secures specially designed ISOFIX child safety seats to the vehicle itself, virtually eliminating the dangers that can result from improper installation

Electronic: • Electronic Stability Programme-plus (ESP-plus) – Reduces the possibility of losing control of the vehicle • Anti-lock Braking System (ABS) • Electronic brakeforce distribution • Cornering brake control • Hydraulic brake fade assist – Automatically raises braking pressure to compensate for brake fade under repeated applications of heavy braking • Emergency brake assist – Increases brake force applied in emergency braking situations • Straight line stability control • Traction control • Adaptive brake lights – If the driver brakes hard enough to activate the ABS function the brake lights flash on and off at a frequency of four times per second, warning following vehicles that heavy braking is in progress

Body: • Energy-absorbing steering column • Pedal release system – Reduces potential injury to the driver's legs and feet during a severe frontal impact • Laminated windscreen • Side-impact protection beams • Reinforced passenger safety cell • Deformation zones front and rear • Burst-proof door locks and anti-jam door design

SECURITY

Standard features • Driver's internal central locking switch • 'Key left in ignition' audible warning • Electronic theft protection for audio equipment • Remote control central deadlocking (doors, tailgate, fuel filler flap) • Electronic engine deadlock immobiliser • Visible Vehicle Identification Number (VIN) plate • Freewheeling door locks • Locking wheel nuts for alloy wheels

Additional feature

Remote control ultrasonic security alarm system¹

	Sport	Limited Edition	SRi	BiTurbo	Price (£) exc. VAT	Total (£) inc. VAT
	○ ²	●	●	●	204.17	245.00

HEATING AND VENTILATION

Standard features • Air conditioning with air recirculation • Air blend heater with six-speed fan • Side window demist vents and adjustable face-level air vents • Interior pollen filter

Additional feature

Dual-zone electronic climate control incorporating air conditioning with humidity sensor

	Sport	Limited Edition	SRi	BiTurbo	Price (£) exc. VAT	Total (£) inc. VAT
	○	○	○	○	254.17	305.00

● = Standard equipment. ○ = Optional at extra cost.

1 = Not available in conjunction with optional panoramic windscreen. 2 = Optional at extra cost on 1.4i 16v VVT Turbo (120PS) Sport models. Standard on all other models.

ASTRA GTC FEATURES/OPTIONS

FACIA, INSTRUMENTS AND CONTROLS

Standard features • Cruise control • Rev counter • Multi-function display showing time, date, audio information and outside air temperature • Digital clock with automatic RDS time adjustment • Steering column adjustable for reach and rake • Electronic odometer and trip odometer • Instrument panel light dimmer • Parking brake-on/low brake fluid level and low fuel level warning lights • Service interval monitor • Seatbelt unfastened warning light (front seats only)

	<i>Sport</i>	<i>Limited Edition</i>	<i>SRI</i>	<i>BiTurbo</i>	Price (£) exc. VAT	Total (£) inc. VAT
Additional features						
Three-spoke chrome-bezelled leather-covered steering wheel	●	●	●			
Three-spoke chrome-bezelled leather-covered flat-bottomed steering wheel				●		
Electric parking brake			○	●	187.50	225.00
Leather-covered gear knob (manual models only)			●	●		
Multi-function trip computer (instantaneous fuel consumption, average fuel consumption, range remaining, two trip odometers running concurrently, instantaneous speed, average speed)			●	●		

INTERIOR LIGHTING

Standard features • Fade up/fade down courtesy lights operated by door switches • Map reading lights integral with front courtesy light • Illuminated glovebox and luggage area

	<i>Sport</i>	<i>Limited Edition</i>	<i>SRI</i>	<i>BiTurbo</i>	Price (£) exc. VAT	Total (£) inc. VAT
Additional features						
Ambient lighting in front doors			●	●		
Ambient lighting in centre console surround			●	●		

SEATING AND UPHOLSTERY

Standard features • Driver's and front passenger's seats with height, reach and recline adjustment • 60/40 split-folding rear seat back • Storage pockets on front seat backs

	<i>Sport</i>	<i>Limited Edition</i>	<i>SRI</i>	<i>BiTurbo</i>	Price (£) exc. VAT	Total (£) inc. VAT
Additional features						
Silvanus cloth seat trim	●	●				
Jet Black Imola cloth seat trim with Morrocana-trimmed side bolsters			●			
Jet Black Track cloth seat trim with Morrocana-trimmed side bolsters				●		
Morrello Red Imola cloth seat trim with Morrocana-trimmed side bolsters (not available with Deep Sky Blue, Sculpture Bronze, Emerald Green and Flaming Yellow exterior colours)			N/C		No-cost option	
Leather seat facings – front and outer rear seats (includes heated front seats with variable temperature settings)			□	□		
Sports front seats			●	●		

● = Standard equipment. ○ = Optional at extra cost. □ = Available as part of an option pack. See options pack table. N/C = No-cost option.

ASTRA GTC FEATURES/OPTIONS

ADDITIONAL INTERIOR FEATURES

Standard features • 12-volt auxiliary power socket within front centre console • Twin sunvisors incorporating illuminated driver's and front passenger's vanity mirrors with covers • Chrome-effect internal door handles • Storage box on driver's side lower fascia • Front door pockets • Fully carpeted luggage area • Load restraint lashing eyes • Luggage compartment cover

	Sport	Limited Edition	SRI	BiTurbo	Price (£) exc. VAT	Total (£) inc. VAT
Additional features						
Dolomite pearl-effect centre console and door inserts	●	●				
Liquid palladium/piano black-effect centre console and door inserts			●	●		
Central storage facility with twin covered drinks holders			●	●		
Electro-chromatic anti-dazzle rear-view mirror ¹	□	□	●	●		

MECHANICAL

Standard features • HiPerStrut (High Performance Strut) • Semi-independent rear suspension with Watt's link and gas-pressure dampers • Sports suspension • Power-assisted steering • Six-speed manual gearbox

	Sport	Limited Edition	SRI	BiTurbo	Price (£) exc. VAT	Total (£) inc. VAT
Additional features						
Lowered and uprated suspension				●		
FlexRide adaptive chassis control system with continuous damping control ³	○	○	○	○	658.33	790.00

EXTERIOR STYLING AND PROTECTION

Standard features • Body-colour door handles • Body-colour door mirrors • Black trim on door pillars

	Sport	Limited Edition	SRI	BiTurbo	Price (£) exc. VAT	Total (£) inc. VAT
Additional features						
Chrome-effect front door sill covers and upper side window mouldings			●	●		
Chrome-effect upper grille surround	●		●			
Body-colour upper grille				●		
Sports style front and rear body-colour bumpers		●		●		
Body-colour rear roof spoiler	○	●	○	●	333.33	400.00
Visible stainless steel exhaust tailpipe (excludes 1.4i 16v VVT Turbo (120PS)/1.7CDTi 16v)	●	●	●			
Twin visible stainless steel exhaust tailpipes (1.6i 16v Direct Injection Turbo (200PS) and 2.0CDTi 16v (195PS) BiTurbo only)	●	●	●	●		
Brilliant paint	○	○	○	○	229.17	275.00
Two-coat metallic or pearlescent paint	○	○	○	○	437.50	525.00

● = Standard equipment. ○ = Optional at extra cost. □ = Available as part of an option pack. See option packs table.

1 = Not available in conjunction with optional panoramic windscreen. 3 = Not available on 1.7CDTi 16v (110PS/130PS) ecoFLEX Start/Stop (109g/km) models.

ASTRA GTC FEATURES/OPTIONS

EXTERIOR LIGHTING

Standard features • Lights-on audible warning • LED centre brake light • Reversing light, rear fog light, hazard warning lights, side repeat indicators • Ellipsoid headlights • Electric headlight beam levelling • Dark-style headlights • Daytime running lights • Dark-style tail lights

	<i>Sport</i>	<i>Limited Edition</i>	<i>SRI</i>	<i>BiTurbo</i>	Price (£) exc. VAT	Total (£) inc. VAT
Additional features						
Intelligent Adaptive Forward Lighting (AFL) ⁴ incorporating dark-style bi-xenon headlights with dynamic beam levelling, LED daytime running lights and high-pressure headlight washers	<input type="checkbox"/>	<input type="checkbox"/>	<input type="checkbox"/>	<input type="checkbox"/>		
Front fog lights			●	●		
Automatic lighting control with tunnel detection and digital high beam assist ¹	<input type="checkbox"/>	<input type="checkbox"/>	●	●		
LED rear lights	○	○	○	○	95.83	115.00

EXTERIOR AND CONVENIENCE FEATURES

Standard features • Electrically operated front windows with safety autoreverse and one-touch facility • Twin electrically adjustable/heated door mirrors (wide angle on driver's side) • Manually foldable door mirrors • Tinted glass • Windscreen wipers with variable intermittent facility and flick-wipe • Twin-jet windscreen washer nozzles • Heated rear window with automatic timed cut-off • Intermittent rear window wash/wipe • Gas-assisted tailgate struts • Folding key • Dual-tone horn

	<i>Sport</i>	<i>Limited Edition</i>	<i>SRI</i>	<i>BiTurbo</i>	Price (£) exc. VAT	Total (£) inc. VAT
Additional features						
Hill start assist	● ⁵	● ⁵	● ⁵	●		
Electrically foldable door mirrors	○	○	○	○	145.83	175.00
Rain-sensitive windscreen wipers ¹	<input type="checkbox"/>	<input type="checkbox"/>	●	●		
Dark-tinted rear windows	○	●	●	●	220.83	265.00
Front and rear parking distance sensors	○		○		320.83	385.00
Rear parking distance sensors				○	162.50	195.00
Panoramic windscreen ⁶	○	○	○	○	708.33	850.00

● = Standard equipment. ○ = Optional at extra cost. = Available as part of an option pack. See option packs table.

¹ = Not available in conjunction with optional panoramic windscreen. ⁴ = Only features Static cornering and Dynamic curve functions when ordered in conjunction with optional panoramic windscreen. ⁵ = Only in conjunction with optional electronic parking brake or automatic transmission.

⁶ = Not available in conjunction with optional Navi 950 IntelliLink, mobile phone system with Bluetooth® or Sight and Light Pack. Deletes remote control ultrasonic security alarm system and twin sunvisors incorporating illuminated driver's and front passenger's vanity mirrors with covers. On SRI and BiTurbo models Sight and Light Pack is deleted. On Limited Edition models Bluetooth® mobile phone system is deleted.

ASTRA GTC FEATURES/OPTIONS

OPTION PACKS

	<i>Sport</i>	<i>Limited Edition</i>	<i>SRI</i>	<i>B/Turbo</i>	Price (£) exc. VAT	Total (£) inc. VAT
Sight and Light Pack ¹ • Automatic lighting control with tunnel detection • Rain-sensitive windscreen wipers • Electro-chromatic anti-dazzle rear-view mirror • Digital high beam assist	○	○	●	●	191.67	230.00
Driving Assistance Pack ¹ • Automatic lighting control with tunnel detection • Rain-sensitive windscreen wipers • Electro-chromatic anti-dazzle rear-view mirror • Digital high beam assist • Forward collision alert • Lane departure warning • Traffic sign recognition • Following distance indicator • Intelligent light ranging ⁷ • Translucent instruments with chrome edging ⁸	○	○	○	○	625.00	750.00
Leather Pack • Leather seat facings (front and outer rear seats) • Electrically heated front seats • Driver's ergonomic sports front seat • Front passenger's extendable seat cushion			○	○	875.00	1050.00
Seat Comfort Pack One • Driver's seat with six-way manual adjustment and four-way electrical lumbar adjustment	○	○	○ ¹⁰	○ ¹⁰	141.67	170.00
Seat Comfort Pack Two ⁹ • Driver's and front passenger's seat with six-way manual adjustment and four-way electrical lumbar adjustment	○	○	○ ¹⁰	○ ¹⁰	266.67	320.00
Premium Forward Lighting Pack • Intelligent Adaptive Forward Lighting (AFL) ⁴ • Dark-style bi-xenon headlights with dynamic beam levelling • LED daytime running lights • High-pressure headlight washers	○ ¹¹	○ ¹¹	○	○	658.33	790.00
Perimeter Protection Pack ¹² • Advance park assist • Side blind spot alert • Electrically foldable door mirrors	○		○		662.50	795.00
VXR Styling Pack ¹³ • Body-colour front lower spoiler, side sills, rear lower skirt and rear spoiler	○		○		666.67	800.00
Towing Pack • Detachable tow bar • Trailer stability programme	○		○	○	291.67	350.00

AUDIO, COMMUNICATION AND NAVIGATION

<i>Features</i>	<i>Sport</i>	<i>Limited Edition</i>	<i>SRI</i>	<i>B/Turbo</i>	Price (£) exc. VAT	Total (£) inc. VAT
CD 400+ • CD/MP3 CD player • AM/FM stereo radio with 36 station presets • Aux-in socket • RDS with Traffic Programme • Graphic display • 20 watts per channel output • 6 speakers • Shark fin/integrated aerial	●	●	●	●		
Navi 650* • Satellite navigation system • Street level mapping for UK and Ireland • Major route mapping for Western Europe • CD/MP3 CD player • Aux-in socket • USB connection with iPod control • AM/FM stereo radio with 36 station presets • RDS with Traffic Programme • High resolution 7-inch colour monitor • 20 watts per channel output • 7 premium speakers • Shark fin/integrated aerial	○	○	○	○	712.50	855.00
Navi 950 IntelliLink ¹ • Satellite navigation system • Street level mapping for Europe • CD/MP3 CD player • Mobile phone system with Bluetooth® (does not include phone) • Aux-in socket • USB connection with iPod control • AM/FM stereo radio with 36 station presets • Audio streaming • IntelliLink • RDS with Traffic Programme • High resolution 7-inch colour monitor • 20 watts per channel output • 7 premium speakers • Shark fin/integrated aerial	○	○	○	○	1000.00	1200.00
Infinity® Premium Sound System ¹⁴ • 7 x 45 Watt amplifier (315 Watt total) • Digital Sound Processor (DSP) • One front mounted 3.5-inch medium range speaker • Two A-pillar mounted 1-inch tweeters • Two front door mounted 6.5-inch subwoofers • Two rear mounted 6.5-inch wide-band speakers • One 8-inch subwoofer box in luggage compartment	○	○	○	○	437.50	525.00
Digital radio with integrated aerial	●	●	●	●		
USB connection with iPod control	●	●	●	●		
Steering wheel mounted audio controls	●	●	●	●		
Bluetooth® mobile phone system (does not include phone) ¹	○	●	○	○	183.33	220.00

● = Standard equipment. ○ = Optional at extra cost. * = Voice control not available in conjunction with Navi 650.

1 = Not available in conjunction with optional panoramic windscreen. 4 = Only features Static cornering and Dynamic curve functions when ordered in conjunction with optional panoramic windscreen. 7 = Requires Premium Forward Lighting Pack. 8 = Sport models only. 9 = Seat Comfort Pack Two includes the contents of Seat Comfort Pack One. Can be ordered separately. 10 = Not available in conjunction with Leather Pack. 11 = Only available in conjunction with optional Sight and Light Pack. 12 = Not available in conjunction with optional VXR Styling Pack. 13 = Does not include visible stainless steel exhaust tailpipe. Not available in conjunction with optional Perimeter Protection Pack. 14 = Adds FlexFloor luggage compartment. Luggage capacity will be reduced.

ASTRA GTC FEATURES/OPTIONS

SATELLITE NAVIGATION

The optional Navi 650/950 satellite navigation systems offer dynamic route guidance via RDS-TMC (Traffic Message Channel) with directions given audibly and via the 7-inch colour monitor. TMC is a specific application of RDS used for broadcasting real-time traffic information. It alerts the driver to a problem on the planned route and calculates an alternative route to avoid the incident.

In addition to route planning criteria such as 'shortest distance' or 'avoiding toll roads', you can now select an energy-optimised 'green route'. Here you can specify parameters such as if you are towing a caravan or have a roof box fitted. The system will use this information, in conjunction with known factors including your vehicle's weight and engine type, to calculate the most fuel-efficient route.

The Navi 650 system covers all major link roads and streets in towns and cities across mainland Britain and Ireland, plus trunk and main roads for Western Europe. Additional country-specific maps with street level detail are available to download. Navi 950 IntelliLink covers street level mapping across Europe. The CD player plays regular audio CDs and MP3 tracks recorded to CD.

USB CONNECTION

Fitted as standard, the USB connection is located alongside the aux-in within the centre console. It provides iPod control and read-out of iPod functions through the audio system display. Traditional aux-in only allow control of volume through the car's audio system. The USB connection also means that the iPod will charge whilst it is connected.

DIGITAL RADIO

Now widely available in the UK, digital multi-media broadcasts offer the user a variety of advantages over traditional FM, starting with the digital quality sound which is immune to any hiss or crackle. You'll often find a broader range of stations on offer too, many of which are not available on FM, and listening to them couldn't be easier – you simply select the station, by name, from the displayed list, thus removing the need to retune or look for stations when travelling around. Some stations will even display the artists' names and song titles on the car's graphic display, while they're played.

BLUETOOTH® MOBILE PHONE SYSTEM WITH VOICE ACTIVATION

Vauxhall's optional factory-fit dual-band Bluetooth® system has been considerably enhanced. Now fully integrated into the audio and communication system, it also features voice control* for certain functions.

All the required information is displayed on the graphic information display when a mobile phone is in use, while the menus are easily navigated by either the steering wheel audio controls or the multi-function button on the radio.

* = Please note, voice control is not available with Navi 650 units.

INTELLILINK





The Navi 950 audio system includes the latest IntelliLink technology, designed to support portable Bluetooth® and USB audio devices, so you can hook up your smartphones or tablets to make calls and access your own music, slideshows, podcasts and more.

INFINITY® PREMIUM SOUND SYSTEM

For the ultimate in premium sound performance Astra GTC can also be specified with the Infinity Sound System. Featuring a 7 x 45 Watt amplifier and Digital Sound Processor, the system comprises eight premium speakers, including one rear-mounted 8-inch subwoofer, two door-mounted and two rear mounted 6.5-inch wide band speakers, two 1-inch tweeters mounted in the A-pillar and a front-mounted 3.5-inch medium range unit. The unit is optional at extra cost on all models.

ASTRA GTC FEATURES/OPTIONS

WHEELS AND TYRES

	<i>Sport</i>	<i>Limited Edition</i>	<i>SRI</i>	<i>BiTurbo</i>	Price (£) exc. VAT	Total (£) inc. VAT
Emergency tyre inflation kit (in lieu of spare wheel)	●	●	●	●		
Space-saver spare wheel (in lieu of emergency tyre inflation kit)	○	○	○		79.17	95.00
 18-inch alloy wheels: 235/50 R 18 tyres	●					
 18-inch alloy wheels: 235/50 R 18 tyres			●			
 18-inch alloy wheels: 235/50 R 18 tyres				●		
 19-inch alloy wheels: 235/45 R 19 tyres	○ ³		○ ³	○	470.83	565.00
 20-inch alloy wheels: 245/40 R 20 tyres			○ ^{3.15}		833.33	1000.00

● = Standard equipment. ○ = Optional at extra cost.

³ = Not available on 1.7CDTi 16v (110/130PS) ecoFLEX Start/Stop (109g/km) models. ¹⁵ = Due to increased CO₂ emissions, there will be a £15 increase in Vehicle Excise Duty payable on 1.4i 16v VVT Turbo (120/140PS) models. On certain engines there will be a slight increase in benefit in kind charges for company car drivers. CO₂ emissions figures: 1.4i 16v VVT Turbo (120/140PS) Start/Stop - 142g/km; 1.4i 16v VVT Turbo (140PS) auto - 156g/km; 1.6i 16v Direct Injection Turbo (200PS) Start/Stop - 156g/km; 2.0CDTi 16v (165PS) auto - 150g/km.



ASTRA GTC FEATURES/OPTIONS

WHEELS AND TYRES

	<i>Sport</i>	<i>Limited Edition</i>	<i>SRI</i>	<i>BiTurbo</i>	Price (£) exc. VAT	Total (£) inc. VAT
 <p>20-inch bi-colour alloy wheels: 245/40 R 20 tyres</p>		●		○	833.33	1000.00

○ = Optional at extra cost.

TYRE RATING

Tyre size	Fuel efficiency group	Wet grip performance	External noise	
			Measured (dB)	Group
235/50 R 18	E	B	71	
235/45 R 19	E	B	68	
245/40 R 20	E	B	71	

Tyre rating according to EU Regulation 1222/2009

ASTRA GTC SPECIFICATIONS

PETROL ENGINES

	1.4i 16v VVT Turbo (120PS) ECOTEC-4 with Start/Stop	1.4i 16v VVT Turbo (140PS) ECOTEC-4 with Start/Stop*	1.6i 16v (200PS) ECOTEC-4 Direct Injection Turbo with Start/Stop
Capacity	1364cc	1364cc	1598cc
Maximum power	120PS (88kW) @ 4200-6000rpm	140PS (103kW) @ 4900-6000rpm	200PS (147kW) @ 5500rpm
Maximum torque	200Nm (147 lb.ft.) @ 1850-4200rpm	200Nm (147 lb.ft.) @ 1850-4900rpm	280Nm (206 lb.ft.)** @ 1650-3500rpm
Configuration	4 cylinders, 4 valves per cylinder, double overhead camshafts	4 cylinders, 4 valves per cylinder, double overhead camshafts	4 cylinders, 4 valves per cylinder, double overhead camshafts
Fuel/induction system	Water-cooled turbocharger with intercooler. Variable Valve Timing (VVT). Multi-point sequential fuel injection	Water-cooled turbocharger with intercooler. Variable Valve Timing (VVT). Multi-point sequential fuel injection	Water-cooled turbocharger with intercooler. Variable Valve Timing (VVT). Central direct fuel injection
Emission compliance	Euro 5	Euro 5	Euro 5
Service interval	20,000 miles or 1 year (whichever occurs sooner)	20,000 miles or 1 year (whichever occurs sooner)	20,000 miles or 1 year (whichever occurs sooner)
Benefit in kind company car taxation rates – 2014/15 tax year			
Manual	20%†	20%†	23%†
Automatic	-	23%†	-

* = Start/Stop function is not available on automatic models. ** = Increased to 300Nm (221 lb.ft.) with overboost. † = Please note: benefit in kind rate is 1% higher for models fitted with 20-inch wheels.

ASTRA GTC SPECIFICATIONS

DIESEL ENGINES

	1.7CDTi 16v (110PS) ECOTEC-4 Turbo diesel with Start/Stop	1.7CDTi 16v (130PS) ECOTEC-4 Turbo diesel with Start/Stop	2.0CDTi 16v (165PS) ECOTEC-4 Turbo diesel with Start/Stop*
Capacity	1686cc	1686cc	1956cc
Maximum power	110PS (81kW) @ 4000rpm	130PS (96kW) @ 4000rpm	165PS (121kW) @ 4000rpm
Maximum torque	280Nm (206 lb.ft.) @ 1750-2500rpm	300Nm (221 lb.ft.) @ 2000-2500rpm	350Nm (258 lb.ft.) @ 1750-2500rpm
Configuration	4 cylinders, 4 valves per cylinder, double overhead camshafts	4 cylinders, 4 valves per cylinder, double overhead camshafts	4 cylinders, 4 valves per cylinder, double overhead camshafts
Fuel/induction system	Variable geometry turbocharger with intercooler. Common rail fuel injection	Variable geometry turbocharger with intercooler. Common rail fuel injection	Variable geometry turbocharger with intercooler. Common rail fuel injection
Emission compliance	Euro 5 with Diesel Particulate Filter	Euro 5 with Diesel Particulate Filter	Euro 5 with Diesel Particulate Filter
Service interval	20,000 miles or 1 year (whichever occurs sooner)	20,000 miles or 1 year (whichever occurs sooner)	20,000 miles or 1 year (whichever occurs sooner)
<i>Benefit in kind company car taxation rates – 2014/15 tax year</i>			
Manual	18%**/17%†	18%**/17%†	21%
Automatic	-	-	25%**

	2.0CDTi 16v (195PS) BiTurbo ECOTEC-4 Start/Stop
Capacity	1956cc
Maximum power	195PS (143kW) @ 4000rpm
Maximum torque	400Nm (295 lb.ft.) @ 1750-2500rpm
Configuration	4 cylinders, 4 valves per cylinder, double overhead camshafts
Fuel/induction system	2 turbochargers with intercooler. Common rail fuel injection
Emission compliance	Euro 5 with Diesel Particulate Filter
Service interval	20,000 miles or 1 year (whichever occurs sooner)
<i>Benefit in kind company car taxation rates – 2014/15 tax year</i>	
Manual	21%
Automatic	-

* = Start/Stop function is not available on automatic models. ** = Please note: benefit in kind rate is 1% higher for models fitted with 20-inch wheels. † = ecoFLEX Start/Stop (109g/km) models.

ASTRA GTC SPECIFICATIONS

PERFORMANCE, FUEL ECONOMY AND EMISSIONS

	Wheel size (inches)	Performance (manufacturer's figures)		Fuel economy mpg (litres/100km)#			CO ₂ emissions g/km#	Vehicle Excise Duty* First year rate	Duty* Standard rate
		Maximum speed (mph)	Acceleration 0-60mph (sec)	Urban driving	Extra-urban driving	Combined figure			
Manual									
1.4i 16v VVT Turbo (120PS) Start/Stop	18/19	119	10.2	37.2 (7.6)	57.6 (4.9)	47.9 (5.9)	139	£130	£130
1.4i 16v VVT Turbo (120PS) Start/Stop	20	119	10.2	36.2 (7.8)	56.5 (5.0)	47.1 (6.0)	142	£145	£145
1.4i 16v VVT Turbo (140PS) Start/Stop	18/19	125	9.0	37.2 (7.6)	57.6 (4.9)	47.9 (5.9)	139	£130	£130
1.4i 16v VVT Turbo (140PS) Start/Stop	20	125	9.0	36.2 (7.8)	56.5 (5.0)	47.1 (6.0)	142	£145	£145
1.6i 16v Direct Injection Turbo (200PS) Start/Stop	18/19	143	7.3	33.6 (8.4)	51.4 (5.5)	42.8 (6.6)	154	£180	£180
1.6i 16v Direct Injection Turbo (200PS) Start/Stop	20	143	7.3	33.6 (8.4)	50.4 (5.6)	42.2 (6.7)	156	£180	£180
1.7CDTi 16v (110PS) ecoFLEX Start/Stop	18/19	113	11.0	58.9 (4.8)	70.6 (4.0)	65.7 (4.3)	114	£0	£30
1.7CDTi 16v (110PS) ecoFLEX Start/Stop	20	113	11.0	58.9 (4.8)	68.9 (4.1)	64.2 (4.4)	116	£0	£30
1.7CDTi 16v (110PS) ecoFLEX Start/Stop (109g/km)	18	114	11.3	58.9 (4.8)	78.5 (3.6)	68.9 (4.1)	109	£0	£20
1.7CDTi 16v (130PS) ecoFLEX Start/Stop	18/19	122	10.0	58.9 (4.8)	70.6 (4.0)	65.7 (4.3)	114	£0	£30
1.7CDTi 16v (130PS) ecoFLEX Start/Stop	20	122	10.0	58.9 (4.8)	68.9 (4.1)	64.2 (4.4)	116	£0	£30
1.7CDTi 16v (130PS) ecoFLEX Start/Stop (109g/km)	18	122	10.1	58.9 (4.8)	78.5 (3.6)	68.9 (4.1)	109	£0	£20
2.0CDTi 16v (165PS) Start/Stop	18/19	131	8.4	49.6 (5.7)	65.7 (4.3)	58.9 (4.8)	127	£0	£110
2.0CDTi 16v (165PS) Start/Stop	20	131	8.4	48.7 (5.8)	64.2 (4.4)	57.6 (4.9)	129	£0	£110
2.0CDTi 16v (195PS) BiTurbo Start/Stop	18/19/20	140	7.7	47.0 (6.0)	66.7 (4.2)	57.7 (4.9)	129	£0	£110
Automatic									
1.4i 16v VVT Turbo (140PS)	18/19	124	9.9	32.8 (8.6)	52.3 (5.4)	42.8 (6.6)	154	£180	£180
1.4i 16v VVT Turbo (140PS)	20	124	9.9	32.5 (8.7)	51.4 (5.5)	42.8 (6.6)	156	£180	£180
2.0CDTi 16v (165PS)	18/19	129	8.6	36.2 (7.8)	62.8 (4.5)	49.6 (5.7)	149	£145	£145
2.0CDTi 16v (165PS)	20	129	8.6	36.2 (7.8)	62.8 (4.5)	49.6 (5.7)	150	£145	£145

* = Correct at time of publication.

= Official Government Test Environmental Data. Official EU-regulated test data is provided for comparison purposes and actual performance will depend on driving style, road conditions and other non-technical factors.

ASTRA GTC SPECIFICATIONS

TRANSMISSION

Six-speed automatic transmission with ActiveSelect® function

A six-speed automatic transmission is optional on 1.4i 16v VVT Turbo (140PS) and 2.0CDTi 16v (165PS) models. On the road, a wide selection of shift patterns is adapted to the style and habits of the driver, anticipating when maximum acceleration or maximum efficiency is required. The electronic control will also adapt to the prevailing road conditions, reducing gear shifting when climbing or descending and using engine braking assistance during down changes.

The ActiveSelect® manual mode allows the gear lever to be used like a sequential manual gearbox – you simply push the lever forward or back to change up or down the gears. The driver also benefits from a 'neutral' gear disengagement at idle, which reduces vibration and contributes to improved fuel consumption.

STEERING

- Power-assisted steering
- Turning circle (kerb-to-kerb):
– 10.9m (35.7ft.)

SUSPENSION

The HiPerStrut (High Performance Strut) front suspension improves grip and allows more power to be applied during cornering. The reduced kingpin angle means less camber loss, which allows the front tyres to retain more of their contact patch with the road during cornering, therefore delaying the onset of understeer. The shorter spindle length significantly reduces torque steer reactions and improves resistance to steering kickback through uneven bends.

Front: Independent. HiPerStrut sports suspension with gas-pressure dampers and coil springs. Anti-roll bar.

Rear: Lightweight compound crank rear axle with one-piece, hollow cast trailing arms. Built-in anti-roll bar. Progressive-rate double conical mini-block springs with Watt's link and gas-pressure dampers.

BRAKES

- Anti-lock Braking System (ABS)
- Electronic brakeforce distribution
- Hydraulic brake fade assist
- Cornering brake control
- Emergency brake assist
- Electric parking brake (standard on BiTurbo models)
- Hill start assist (standard on BiTurbo models)

FUEL TANK CAPACITY

All models: 56 litres (12.3 gallons)

VAUXHALL LIFETIME WARRANTY

We're so confident in Vauxhall quality and reliability that we are now able to offer a lifetime warranty. Available to the first owner of all new Vauxhall passenger cars, it's valid for the lifetime of the vehicle up to a maximum of 100,000 miles*.

In addition our warranty also includes Vauxhall Assistance for 12 months from first registration and six years body panel anti-perforation warranty. Full details of Vauxhall's warranties including terms, conditions and exclusions can be obtained through any authorised Vauxhall Retailer or go to www.vauxhall.co.uk/warranty



*Vauxhall Lifetime Warranty covers lifetime ownership of first car owner, 100,000 mile limit, annual check required. The warranty excludes wear and tear and serviceable items and the vehicle must be serviced in accordance with the manufacturer's servicing schedule to continue the lifetime warranty. Terms and conditions apply. Offer available to all Vauxhall passenger cars, (this offer does not apply to car-derived vans) from 1st August 2010.

WEIGHTS AND TOWING DATA kg

	Gross vehicle weight	Max. towing weights Trailer with brakes (without brakes)
1.4i 16v VVT Turbo (120PS) Start/Stop	1960	1350 (700)
1.4i 16v VVT Turbo (140PS) Start/Stop	1960	1350 (700)
1.4i 16v VVT Turbo (140PS) (automatic)	1980	1350 (700)
1.6i 16v Direct Injection Turbo (200PS) Start Stop	1990	1500 (730)
1.7CDTi 16v (110PS) ecoFLEX Start/Stop	2005	1200 (730)
1.7CDTi 16v (110PS) ecoFLEX Start/Stop (109g/km)	2020	1300 (730)
1.7CDTi 16v (130PS) ecoFLEX Start/Stop	2005	1200 (730)
1.7CDTi 16v (130PS) ecoFLEX Start/Stop (109g/km)	2020	950 (730)
2.0CDTi 16v (165PS) Start/Stop	2040	1500 (750)
2.0CDTi 16v (165PS) (automatic)	2060	1450 (750)
2.0CDTi 16v (195PS) BiTurbo Start/Stop	2040	1500 (750)

Gross vehicle weight is the total permissible weight of the vehicle including passengers and their luggage. The maximum roof rack loading should not exceed 100kg. The maximum towing weights are based on the ability of the car, with two occupants of 75kg each, to restart on a 12% gradient, which is approximately 1 in 8.3, at sea level. At altitudes above 1500 metres, the engine output may drop with a corresponding reduction in towing capability. Any extra weight, such as luggage or additional passengers, should be deducted from the maximum towing weight. With a trailer fully loaded, maximum noseweight should not exceed 75kg. Always fit Vauxhall towing attachments and accessories available from your Vauxhall retailer. They are designed specifically for Vauxhall models and carry a 12-month guarantee.

ASTRA GTC SPECIFICATIONS

EXTERIOR DIMENSIONS millimetres (inches)

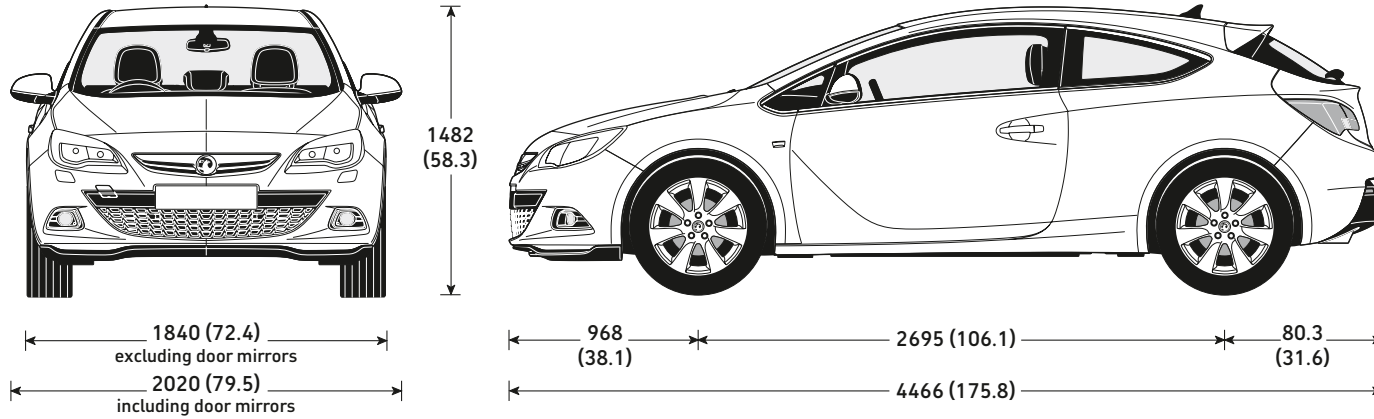

LUGGAGE CAPACITIES*

	litres (cu.ft.)
Rear seats up	380 (13.4)
Rear seats down	1165 (41.1)

Please note fitment of Infinity® Sound System reduces load volume by 38 litres.

* = Measured using the ECIE method.

ASTRA GTC ACCESSORIES

	Total (inc. VAT)
INFOTAINMENT*	
iPod connection kit	
Connects2 i-Connect FM – FM modular	£129.00
Bury Bluetooth® phone kits	
CV9040 – Portable, colour screen, voice recognition	£99.00
Classic – Fully integrated, phone charging function, illuminated controls	£149.00
CC9060 – Fully integrated, detachable colour screen, voice recognition	£249.00
Garmin Portable Sat Navs (includes case)	
Nüvi 4.3 (UK/Ireland) – 4.3-inch screen	£89.00
Nüvi 4.3 (Western Europe) – 4.3-inch screen, Bluetooth, eco route	£99.00
Nüvi 5 (UK/Ireland) – 5-inch screen, Bluetooth, eco route, lifetime traffic alerts	£99.00
Nüvi 5 (Western Europe) – 5-inch screen, Bluetooth, eco route	£109.00
Digital radio*	
Fully integrated digital radio	£195.00
Sat Nav updates¹	
Please consult your retailer for latest map updates or visit www.vauxhall.co.uk/accessories .	

¹ = For use with optional factory-fit satellite navigation systems.

	Total (inc. VAT)
CHILD SEATS²	
BABY-SAFE ³ – 0-13kg/birth to 15 months	£120.00
– ISOFIX base	£208.00
– ISOFIX bracket	£243.00
DUO ISOFIX ³ – 9-18kg/9 months to 4 years	
with top tether kit	£317.00
KID ³ – 15-36kg or 4 to 12 years	£144.00
Vauxhall baby mirror	£17.00
2 = Restrictions apply to the use of child seats, please consult your Vauxhall retailer.	
3 = Without transponder.	
SAFETY	
Privacy shades – rear and rear side windows	£101.00
Parking sensors*	
– four fully flush front bumper mounted sensors	
– unpainted	£320.00
– painted	£350.00
– four fully flush rear bumper mounted sensors	
– unpainted	£300.00
– painted	£330.00
Safety Pack – first aid kit, warning triangle, hi-visibility vest, Vauxhall bag	
First aid kit	£13.00
Warning triangle	£16.00
Fire extinguisher – 2kg	£34.00
Hi-visibility vest	£8.00
Temporary tyre inflation kit	£129.00
Tyre sealant – 700ml	£48.00

	Total (inc. VAT)
PRACTICAL	
Spare bulb kit ⁴	£17.00
Premium spare bulb kit ⁴	£29.00
Jump leads	
– petrol engines (16mm standard)	£42.00
– petrol/diesel engines (25mm heavy duty)	£75.00
Fuel can – 5 litre	£20.00
Stretch tow rope – 2 tonne	£31.00
Smoker pack	£39.00
4 = Excludes xenon headlight bulb for models with Adaptive Forward Lighting (AFL).	

	Total (inc. VAT)
PROTECTION	
Economy floor mats – set of four	£26.00
Rubber floor mats – set of four	£58.00
Velour floor mats – set of four	£66.00
Cargo liner	£65.00
Cargo net – horizontal	£40.00
Storage net – front passenger seat	£43.00

	Total (inc. VAT)
TOURING	
T-track base carrier – two roof bars	£125.00
Thule aluminium bike carrier ⁵	£100.00
Thule ski carrier ⁵	from £115.00
Thule extendable ski carrier ⁵	£215.00
Thule aluminium surfboard carrier ⁵	£92.00
Thule Ocean 80 hard roof box (340 litres) ⁵	£215.00
Thule Pacific 200 hard roof box (460 litres) ⁵	from £320.00
Thule Ranger 90 soft roof box (340 litres) ⁵	£260.00
Two-bicycle tow bar carrier with rear lights	
– requires rear number plate	£410.00
Additional bicycle carrier – for use with two-bicycle tow bar carrier	
two-bicycle tow bar carrier	£97.00
Detachable tow bar ⁶	from £695.00

⁵ = Must be used in conjunction with a base carrier.

⁶ = Available with 12N, 12N/125 or 13-pin electrics. Please consult your retailer for details.

	Total (inc. VAT)
VXR STYLING	
VXR rear roof spoiler [†]	£405.00
Door sill plates*	£70.00

* = Fully fitted price – available at participating retailers only.

** = CD player not included.

† = Painted and fully fitted price – available at participating retailers.

ASTRA GTC ADDITIONAL INFORMATION

ON-THE-ROAD PRICES

To eliminate uncertainty about hidden costs when buying a new car, Vauxhall publishes on-the-road recommended retail prices (RRP) and these are shown in the pricing tables within this price guide. These prices include the recommended cost of number plates and delivery to a Vauxhall retailer of £700.00 (including £116.67 VAT), 12 months' Government Vehicle Excise Duty (see opposite for details) and the DVLA new vehicle first registration fee of £55.00*.

Please note: The on-the-road recommended retail price (RRP) does not include fuel supplied by the retailer, motor insurance or any other goods or services supplied by agreement between the retailer and the customer.

PRICE PROTECTION

Order a new Vauxhall for build in the current model year (as confirmed by your retailer) for delivery no more than three months in advance and the price you are quoted is the price you pay. This is irrespective of any subsequent price rises between placing your order and delivery of your new car, but you must take delivery as soon as the car is available. General Motors UK Limited is not liable for price adjustments caused by Government changes in the rate of VAT (currently 20%), Vehicle Excise Duty, DVLA new vehicle first registration fee or by any other applicable legislation or regulations.

VEHICLE EXCISE DUTY

The amount of Vehicle Excise Duty (road fund licence) payable on new cars varies depending on the level of carbon dioxide (CO₂) emissions produced by the vehicle. CO₂ emissions are measured in grammes (g) per kilometre (km) travelled and divided into 13 charging bands shown in the table below.

From 1 April 2010 the Government introduced a new 'first year rate' of Vehicle Excise Duty payable on all new cars. In subsequent years the amount of Vehicle Excise Duty payable will revert to the standard rate.

Vehicle Excise Duty*

	CO ₂ emissions (g/km)	First year rate	Standard rate
Band A	up to 100	£0.00	£0.00
Band B	101-110	£0.00	£20.00
Band C	111-120	£0.00	£30.00
Band D	121-130	£0.00	£110.00
Band E	131-140	£130.00	£130.00
Band F	141-150	£145.00	£145.00
Band G	151-165	£180.00	£180.00
Band H	166-175	£290.00	£205.00
Band I	176-185	£345.00	£225.00
Band J	186-200	£485.00	£265.00
Band K	201-225	£635.00	£285.00
Band L	226-255	£860.00	£485.00
Band M	over 255	£1090.00	£500.00

* = Correct at time of issue.

E10 FUEL

E10 fuel is cleared for use in all petrol-engined Vauxhall vehicles excluding models with the 2.2 litre direct injection petrol engine (code Z22YH) used in Vectra, Signum and Zafira models. Owners of these vehicles should continue to use regular unleaded or premium unleaded petrol.

PROTECTING THE ENVIRONMENT

Vauxhall's commitment to the environment is demonstrated by our products' many environmental awards. For even more information on Vauxhall's efforts to achieve an environmentally sustainable future, see www.vauxhall.co.uk/recycling

VAUXHALL ASSISTANCE

Vauxhall Assistance is provided automatically with every new Vauxhall for 12 months from first registration and covers everything from accident assistance, roadside recovery and 'at home' service to flat tyres. With Vauxhall Assistance help is literally just a free** phone call away, 24 hours a day, 365 days a year!

** = Mobile phone users will be charged at their standard tariff.

VAUXHALL LEASING

As Vauxhall's own contract hire and fleet management operation, Vauxhall Leasing provides a one-stop-shop for competitive car and van leasing solutions – for business users and private individuals. Working with the Vauxhall retailer network, we combine the support of a national contract with the convenience of a local contact.

For further information, please see your local Vauxhall retailer or call us on **0870 737 2557**. Alternatively, you can visit our website at www.vauxhall-leasing.co.uk

IN THE EVENT OF AN ACCIDENT...

Vauxhall Accident Support helps keep you mobile following an accident. Benefits include scene-of-accident advice, message service, assistance with claims and vehicle recovery. For further details call **0800 010 304**.

Alternatively, details can be found on our website at www.vauxhall.co.uk

MASTERFIT

Vauxhall's MasterFit retailers offer a great service for owners of all Vauxhall cars. Value for money, regular offers and free check-ups, combined with the peace of mind that comes from using trained technicians and genuine parts, help keep your car in peak condition at all times.

FOR MORE PRODUCT INFORMATION

For a brochure on any Vauxhall model (up to a maximum of three per caller) or location of your nearest Vauxhall retailer please call **0845 600 1500**. Alternatively, details can be found on our website at www.vauxhall.co.uk

VAUXHALL INSURANCE WITH ADDED REASSURANCE

Comprehensive cover – Summary of benefits*

- Competitive premiums
- Repairs by a Vauxhall technician
- Genuine Vauxhall parts, guaranteed for three years when we repair your car within our Approved Repairer Network
- Free courtesy car as standard when using an Approved Repairer**
- 24 hour claims helpline
- Personal Accident benefit
- Cover for audio equipment
- Windscreen cover

Call for a quote on **0844 463 2670†**

*The benefits listed above are for comprehensive cover only. For details of Third Party, Fire and Theft cover, please call our sales team.
**Should your car need repairing following an accident we provide a courtesy car (subject to availability) for the duration of the repair. Only genuine Vauxhall parts are used. Terms and conditions apply.
† Calls may be recorded. Vauxhall Motor Insurance is underwritten by Ageas Insurance Limited.

Every effort has been made to ensure that the contents of this document were accurate and up-to-date at the time of publication – 1 April 2014 (Amended 1 May 2014). The invoice price, including delivery to retailer, factory-fitted options, accessories fitted by the retailer and number plates, is subject to VAT. The right is reserved to alter specifications and prices, and withdraw products from sale, without notice. Please note that Vauxhall retailers are not the agents of General Motors UK Limited t/a Vauxhall and are not authorised to bind General Motors UK Limited by any specific or implied undertaking or representation. It is advisable to ensure that your motor insurance policy provides adequate cover for additional fitted options and accessories. All rights reserved. No part of this publication may be reproduced in any form or by any means, without the prior written permission of General Motors UK Limited.

Base information prepared by Graymatter. General Motors UK Limited, Luton LU1 3YT www.vauxhall.co.uk

©2014 General Motors UK Limited



VAUXHALL