

5 June 2024 | Model Year 2023/24

MY 2023/24



Car Range

Price Guide

Price and Specification Guide
23 May 2024 | Model Year 2024B



New Corsa

Including Electric Range

Contents

To find the information you want use the links below to navigate around the guide:

Models

Prices

Vauxhall PureSense

Vauxhall PureConnect

Comfort and convenience

Safety and security

Styling

Exterior colours

Vauxhall PureEnergy

Specifications

Company car information

Further information

At Vauxhall, we believe great cars are for everyone.

We believe technology works best when it's not just smart but is also simple and intuitive. Where everyone can feel the instant excitement of electric; can keep themselves and their loved ones safer on the road; and can stay connected to the things that matter most, simply and easily. We call it Vauxhall Pure Technology. No gimmicks, nothing complicated, just technology that makes driving better, easier and more exciting, for everyone.

Our latest New Corsa Price and Spec guide outlines the Pure Technology features model by model. Together with all the essential information you need to compare Prices, Technical Information and Specification plus details of our commitment to offer the best in Customer Care.

We're delighted you're considering the purchase of a new Corsa and hope this guide will help you make the right choice.



Design



Design Petrol.



Design Electric.



16-inch alloy wheel.



16-inch alloy wheel.

Standard features include:

PureSense

- LED headlights
- LED daytime running lights
- High beam assist
- Electronic parking brake (auto only)
- Lane departure warning with lane keep assist
- Speed sign recognition
- Hill start assist
- Driver drowsiness alert
- Forward collision alert
- Automatic emergency braking with pedestrian detection
- Cruise control with intelligent speed limiter
- Six airbags
- Rear parking distance sensors

PureConnect*

- Multimedia infotainment system
 - 10-inch colour touchscreen
 - AM/FM/DAB digital radio
 - Bluetooth®
 - Wireless Apple CarPlay/Android Auto™
 - USB connection
- Vauxhall Connect
- 3.5-inch digital colour instrument cluster (Petrol only)
- 7-inch digital colour instrument cluster (Electric only)
- Six speakers

Comfort and convenience

- Air conditioning (Petrol only)
- Electronic climate control (Electric only)
- Flat-bottomed leather-effect steering wheel
- 60/40 split-folding rear seats
- Rain-sensitive windscreen wipers
- Automatic lighting control
- Automatic anti-dazzle rear-view mirror
- Electrically operated front and rear windows
- Paddle shift (auto Petrol models only)
- Remote control central locking
- Emergency tyre inflation kit (in lieu of spare wheel)

Interior

- Akoya grey fascia with high gloss black insert
- Fresez black fabric seat trim inserts
- Comfort front seats
- Driver's seat (six-way adjustable)
 - Height (up/down)
 - Reach (fore/aft)
 - Backrest (upright/recline)
- Front passenger's seat (four-way adjustable)
 - Reach (fore/aft)
 - Backrest (upright/recline)

Styling

- Chrome Griffin logo
- Black vizzor frame
- 16-inch grey alloy wheels with 195/55 R 16 tyres (Petrol only)
- 16-inch diamond-cut hi-gloss black alloy wheels with 195/55 R 16 tyres (Electric only)
- Black lower side window trim

*For more details see PureConnect page, click [here](#)

Corsa Electric YES/Corsa YES



16-inch alloy wheel.



16-inch alloy wheel (Electric only).
Optional at not extra cost

Standard features include:

PureSense

- LED headlights
- LED daytime running lights
- High beam assist
- Electronic parking brake (auto only)
- Lane departure warning with lane keep assist
- Speed sign recognition
- Hill start assist
- Driver drowsiness alert
- Forward collision alert
- Automatic emergency braking with pedestrian detection
- Cruise control with intelligent speed limiter
- Six airbags
- Rear parking distance sensors

PureConnect*

- Multimedia infotainment system
 - 10-inch colour touchscreen
 - AM/FM/DAB digital radio
 - Bluetooth®
 - Wireless Apple CarPlay/Android Auto™
 - USB connection
- Vauxhall Connect
- 3.5-inch digital colour instrument cluster (Petrol only)
- 7-inch digital colour instrument cluster
- Six speakers

Comfort and convenience

- Air conditioning (Petrol only)
- Electronic climate control (Electric only)
- Flat-bottomed leather-effect steering wheel
- 60/40 split-folding rear seats
- Rain-sensitive windscreen wipers
- Automatic lighting control
- Automatic anti-dazzle rear-view mirror
- Electrically operated front and rear windows
- Paddle shift (auto Petrol models only)
- Remote control central locking
- Emergency tyre inflation kit (in lieu of spare wheel)

Interior

- Akoya grey fascia with high gloss black insert
- Red banda fabric seat trim inserts
- Sports-style front seats
- Driver's seat (six-way adjustable)
 - Height (up/down)
 - Reach (fore/aft)
 - Backrest (upright/recline)
- Front passenger's seat (four-way adjustable)
 - Reach (fore/aft)
 - Backrest (upright/recline)

Styling

- Black Griffin logo
- Black vizor frame
- 16-inch black alloy wheels with 195/55 R 16 tyres
- 16-inch silver bi-colour alloy wheels with 195/55 R 16 tyres (Electric only - optional, at no extra cost)
- Black lower side window trim
- Black roof
- Available paints: Record Red, Carbon Black, Graphic Grey and Artic White

*For more details see PureConnect page, click [here](#)

GS



VX_COR_34370.tif

GS Petrol.



VX_COR_e_34365.tif

GS Electric.



VX_COR_34372.tif

VX_COR_34366.tif

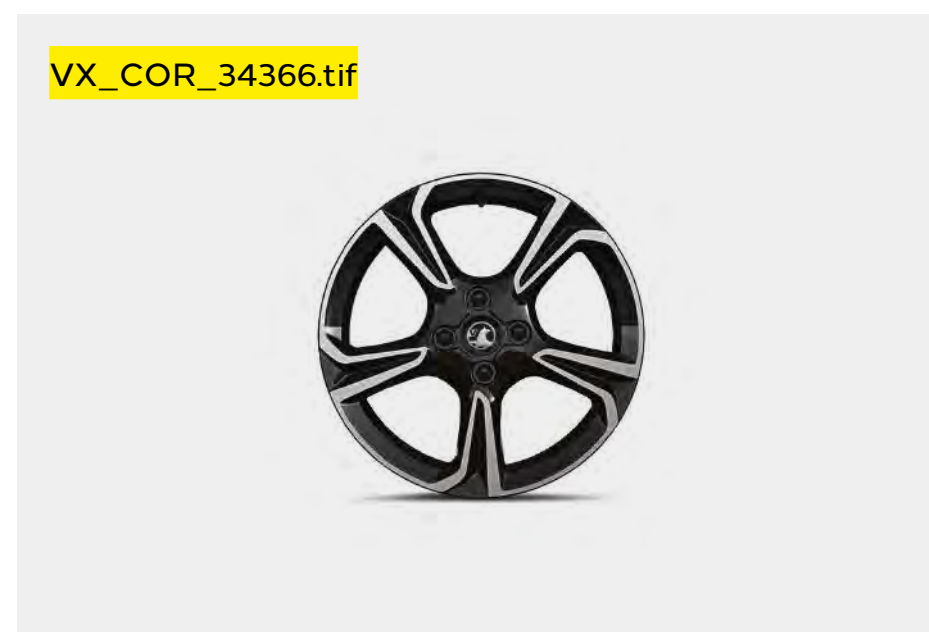

17-inch alloy wheel (Petrol only).

VX_COR_e_34367.tif



17-inch alloy wheel (Electric only).

Features over and above Design:

PureSense

- LED front fog lights
- LED tail lights
- Front and rear parking distance sensors
- Sport switch (not 75PS Petrol engine)
- Rear-view camera (Petrol only)
- Panoramic rear-view camera (Electric only)
- Side blind spot alert

PureConnect*

- Wireless Apple CarPlay/Android Auto™
- Wireless charger for mobile devices (Electric only)
- Multimedia Navi infotainment system (Electric only)
 - 10-inch colour touchscreen
 - Satellite Navigation with European coverage
 - 2D/3D street level mapping
 - Rear USB connection
 - Points-of-interest search

Comfort and convenience

- Electronic climate control
- Front centre armrest with storage
- Keyless entry and start (Electric only)
- Remote control security alarm system
- Electrically adjustable/heated door mirrors
- Electrically folding door mirrors

Interior

- Silent black fascia with liquid palladium insert
- Banda white/marvel black fabric seat trim inserts
- Sports-style front seats

Styling

- Black Griffin logo and vizer frame
- Sports front and rear body styling
- Chrome-effect exhaust tailpipe extension (130PS Petrol models only)
- Dark-tinted rear windows
- Black roof and A-pillars
- High gloss black B-pillars
- Black headliner
- Alloy-effect sports pedals (auto only)
- 17-inch diamond-cut hi-gloss black alloy wheels with 205/45 R 17 tyres (Petrol only)
- 17-inch black alloy wheels with grey inserts and 205/45 R 17 tyres (Electric only)

*For more details see PureConnect page, click [here](#)

Please note, interior illustration features optional Winter Pack.

Ultimate



Ultimate Petrol.



17-inch alloy wheel.



Ultimate Electric.



17-inch alloy wheel.



Features over and above GS:

PureSense

- IntelliLux adaptive LED® Matrix headlights
- Enhanced automatic emergency braking
- Lane positioning assistant (auto only)
- Adaptive cruise control (auto only)
- Extended traffic sign recognition

PureConnect*

- Multimedia Navi infotainment system
 - Satellite Navigation with European coverage
 - Wireless Apple CarPlay/Android Auto™
 - 2D/3D street level mapping
 - Rear USB connection
 - Points-of-interest search

Comfort and convenience

- Heated steering wheel
- Driver's seat with massage function and lumbar support

Interior

- Alcantara seat trim inserts
- Heated comfort front seats
- Front passenger's seat (six-way manual adjustable)

Styling

- Ultimate badging and sill plates
- 17-inch diamond-cut hi-gloss black alloy wheels with 205/45 R 17 tyres (Petrol only)
- 17-inch black alloy wheels with grey inserts and 205/45 R 17 tyres (Electric only)

*For more details see PureConnect page, click [here](#)

Effective 23 May 2024

New Corsa Model Year 2024B

Prices

Electric	LCDV code	Price (£)	VAT (£)	Total (£)	On-the-road RRP (£)	Financial year 2023/24 BiK 20% (£)	WLTP combined CO ₂ (g/km) - LCDV code	Insurance groups
Design								
Electric Propulsion (136PS) auto	1GJOA5HESFT0A0G6	26,241.67	5,248.33	31,490.00	32,445.00	10.80	0	28D
Corsa Electric YES								
Electric Propulsion (136PS) auto	1GJOA5HESFT02CG4	21,616.67	4,323.33	25,940.00	26,895.00	8.95	0	30D
GS								
Electric Propulsion (136PS) auto	1GJOA5TESFT0A0G6	27,604.17	5,520.83	33,125.00	34,080.00	11.34	0	26E
Electric Propulsion (156PS) auto - Long Range	1GJOA5TZIFT0A0G6	28,766.67	5,753.33	34,520.00	35,475.00	11.81	0	28E
Ultimate								
Electric Propulsion (136PS) auto	1GJOA5TESFT040G6	30,195.83	6,039.17	36,235.00	37,190.00	12.38	0	28E
Electric Propulsion (156PS) auto - Long Range	1GJOA5TZIFT040G6	31,358.33	6,271.67	37,630.00	38,585.00	12.84	0	27E

WLTP combined CO₂ (g/km) figures are based on a configured vehicle as per LCDV code for UK with no options fitted.

*Provisional fuel consumption and CO₂ figures are determined according to the WLTP test cycle. CO₂ figures, BiK values and RRP pricing shown above are for a standard vehicle without any additional optional equipment. CO₂ figures are used to calculate Vehicle Excise Duty (VED) for the first registration of the vehicle and BiK. The addition of optional extras could increase the certified CO₂ emission output. This in turn may affect the amount of VED payable upon registration, and, for company car drivers, the P11D value and the amount of Benefit in Kind (BiK) tax payable. Figures shown are for comparison purposes and should only be compared to the fuel consumption and CO₂ values of other cars tested to the same technical standard. The fuel consumption achieved, and CO₂ produced, in real world conditions will depend upon a number of factors including, but not limited to: the accessories fitted (pre and post registration); variations in weather; driving styles and vehicle load. The WLTP (Worldwide Harmonised Light Vehicles Test Procedure) is used to measure fuel consumption and CO₂ figures. Full data relating to WLTP test cycles can be found at: www.vauxhall.co.uk/wltp

Please note: On-the-road recommended retail prices (RRP) include number plates and delivery to Retailer of £900.00 (including £150.00 VAT), 12 months' Vehicle Excise Duty and new vehicle first registration fee of £55.00. Excludes fuel and insurance. Company Car Benefit in Kind (BiK) rates are monthly based on the standard paint price.

Effective 23 May 2024

New Corsa Model Year 2024B

Prices

Petrol	LCDV code	Price (£)	VAT (£)	Total (£)	On-the-road RRP (£)	Financial year 2023/24 BiK 20% (£)	WLTP combined CO ₂ (g/km) [#] - LCDV code	Insurance groups
Design								
1.2 (75PS)	1GJOA5HJUJTOA0G4	15,383.33	3,076.67	18,460.00	19,635.00	93.57	121	12E
1.2 (100PS) Turbo	1GJOA5HL6KTOA0G4	16,133.33	3,226.67	19,360.00	20,535.00	94.55	117	20D
1.2 (100PS) Turbo auto	1GJOA5HL81TOA0G4	17,575.00	3,515.00	21,090.00	22,265.00	109.95	125	19D
1.2 (100PS) Turbo Hybrid e-DCT6 auto	1GJOA5HJGWTOA0G4	18,133.33	3,626.67	21,760.00	22,900.00	94.42	102	20D
Corsa YES								
1.2 (100PS) Turbo	1GJOA5HL6KT02CG4	14,441.67	2,888.33	17,330.00	18,505.00	85.07	117	22D
GS								
1.2 (75PS)	1GJOA5TJUJTOA0G4	17,366.67	3,473.33	20,840.00	22,015.00	105.08	123	12E
1.2 (100PS) Turbo	1GJOA5TL6KTOA0G4	18,116.67	3,623.33	21,740.00	22,915.00	109.43	120	19E
1.2 (100PS) Turbo Hybrid e-DCT6 auto	1GJOA5TJGWTOA0G4	20,116.67	4,023.33	24,140.00	25,280.00	126.70	104	23E
1.2 (130PS) Turbo auto	1GJOA5TM61TOA0G4	20,366.67	4,073.33	24,440.00	25,615.00	104.33	127	19E
1.2 (136PS) Turbo Hybrid e-DCT6 auto	1GJOA5TJHWT0A0G4	20,925.00	4,185.00	25,110.00	26,250.00	112.71	106	25E
Ultimate								
1.2 (100PS) Turbo	1GJOA5TL6KT040G4	20,433.33	4,086.67	24,520.00	25,695.00	122.86	120	19E
1.2 (130PS) Turbo auto	1GJOA5TM61T040G4	22,683.33	4,536.67	27,220.00	28,395.00	140.60	127	23E
1.2 (136PS) Turbo Hybrid e-DCT6 auto	1GJOA5TJHWT040G4	23,241.67	4,648.33	27,890.00	29,030.00	124.76	106	26E

WLTP combined CO₂ (g/km) figures are based on a configured vehicle as per LCDV code for UK with no options fitted.

[#]Provisional fuel consumption and CO₂ figures are determined according to the WLTP test cycle. CO₂ figures, BiK values and RRP pricing shown above are for a standard vehicle without any additional optional equipment. CO₂ figures are used to calculate Vehicle Excise Duty (VED) for the first registration of the vehicle and BiK. The addition of optional extras could increase the certified CO₂ emission output. This in turn may affect the amount of VED payable upon registration, and, for company car drivers, the P11D value and the amount of Benefit in Kind (BiK) tax payable. Figures shown are for comparison purposes and should only be compared to the fuel consumption and CO₂ values of other cars tested to the same technical standard. The fuel consumption achieved, and CO₂ produced, in real world conditions will depend upon a number of factors including, but not limited to: the accessories fitted (pre and post registration); variations in weather; driving styles and vehicle load. The WLTP (Worldwide Harmonised Light Vehicles Test Procedure) is used to measure fuel consumption and CO₂ figures. Full data relating to WLTP test cycles can be found at: www.vauxhall.co.uk/wltp

Please note: On-the-road recommended retail prices (RRP) include number plates and delivery to Retailer of £900.00 (including £150.00 VAT), 12 months' Vehicle Excise Duty and new vehicle first registration fee of £55.00. Excludes fuel and insurance. Company Car Benefit in Kind (BiK) rates are monthly based on the standard paint price.

PureSense

Model specific features	Design	Design Electric	Corsa YES	Corsa Electric YES	GS	GS Electric	Ultimate	Ultimate Electric
Driver assistance								
Cruise control with intelligent speed limiter	●	●	●	●	●	●	●	●
Front camera system – Forward collision alert/Automatic emergency braking with pedestrian detection/Lane departure warning with lane keep assist/Speed sign recognition	●	●	●	●	●	●	●	●
Driver drowsiness alert	●	●	●	●	●	●	●	●
Electronic parking brake	auto only	●		●	auto only	●	●	●
Rear parking distance sensors	●	●	●	●				
Front and rear parking distance sensors					●	●	●	●
Rear-view camera (130°)					●			
Panoramic rear-view camera (180°)						●	●	●
Side blind spot alert					●	●	●	●
Enhanced automatic emergency braking							●	●
Adaptive cruise control							auto only	●
Lane positioning assistant							auto only	●
Exterior lighting								
LED headlights and daytime running lights	●	●	●	●	●	●	●	●
Automatic lighting control	●	●	●	●	●	●	●	●
LED tail lights					●	●	●	●
LED front fog lights					●	●	●	●
Automatic headlight levelling system							●	●
IntelliLux adaptive LED® Matrix headlights							●	●

Please note, Vauxhall driver assistance systems are intended to support the driver within the system-imminent limitations. The driver remains responsible for the driving task at all times.

PureConnect

Multimedia – Design/GS Petrol

Features

- DAB Digital radio
- RDS with Traffic Programme
- AM/FM stereo radio
- Six speakers

Media connections

- USB connection (Type C)
- Bluetooth® audio streaming

Mobile phone portal

- Bluetooth® connectivity

Smartphone interface

- Apple CarPlay and Android Auto™
- Smartphone projection that allows operations via voice command, touchscreen and buttons to control apps and music playback

Additional features

- Steering wheel-mounted audio controls
- Flexible roof-mounted aerial

Multimedia Navi – GS Electric/Ultimate

Features over Multimedia

- Predictive satellite navigation system
- Connected navigation via Vauxhall Connect
- 3D street level mapping
- European coverage • Points-of-interest search
- Over-the-air map updates
- Wireless charger for mobile devices
- Front USB (Type C) and rear USB (Type C/charge only) connections
- Voice recognition
- Shark fin aerial

Driver information

Driver information display (centrally located in instrument cluster)

- Service-due indicator
- Deflation detection system

Multi-function trip computer (displayed on driver information display)

- Trip mileage
- Vehicle range based on remaining fuel
- Average speed
- Average fuel economy
- Instantaneous fuel economy

Central fascia display (format dependent on infotainment unit)

- Audio information
- Digital clock with automatic RDS time adjustment
- Outside air temperature with ice warning function
- Additional features dependent on infotainment unit

Model specific features	Design	Design Electric	Corsa YES	Corsa YES Electric	GS	GS Electric	Ultimate	Ultimate Electric
Driver information								
3.5-inch digital colour instrument cluster	●		●					
7-inch digital colour instrument cluster		●		●	●	●	●	●
Infotainment								
Multimedia with 10-inch touchscreen	●	●			●			
Multimedia Navi with 10-inch touchscreen						●	●	●

Vauxhall Connect



Safety

The more you know, the safer your journey – that's why our smart tech and connected services keep you constantly updated on what's going on inside and outside your vehicle.

Peace of mind

- Emergency call (SOS e-call)
- Breakdown call (b-call)



e-Remote control

Want seamless charging and added levels of comfort? Use e-Remote to schedule charging times, keep an eye on your range and even pre-set your vehicle's cabin temperature before you get in.

Convenience

- E-remote control (Electric only)**
- Remote check of battery level, programming and charge management
- Pre-conditioning of vehicle temperature

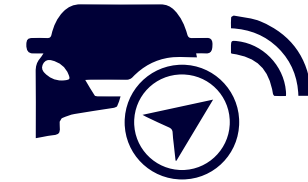

Live navigation plus†

With real-time directions and traffic information from the leading European GPS provider, TomTom®, every journey will be a breeze.

- TomTom® services
- Real time traffic news
- Parking prices and availability
- Weather forecast on your journey
- Natural voice control
- Fuel prices at petrol stations
- Search for charging stations
- Quick search for points of interest
- Road safety alerts



Maintenance

Connected services are here for you – even when things go wrong. Our Intelligent Telemaintenance service monitors the key functions of your vehicle – and notifies you as soon as something needs attention.

- Vehicle status and information**
- Maintenance alerts, fuel level, average fuel consumption and mileage

Vauxhall Connect* is the smart way to stay connected while on the road. Innovative technology systems and related services keep our drivers safe and provide an exciting, efficient yet safe trip.

Download
MyVauxhall now!



Explore MyVauxhall

Ready to make life easier? Meet MyVauxhall – your one-stop shop for everything Vauxhall. Plan journeys from the comfort of your armchair. View your next scheduled service, book a vehicle repair, access your handbook and much more!

Also if you drive an electric vehicle or plug-in hybrid, you'll love our e-Remote Control app feature. Use it to pre-condition your cabin temperature before journeys – and maximise your charge. Or pre-schedule charging times at night, and benefit from cheaper electricity.

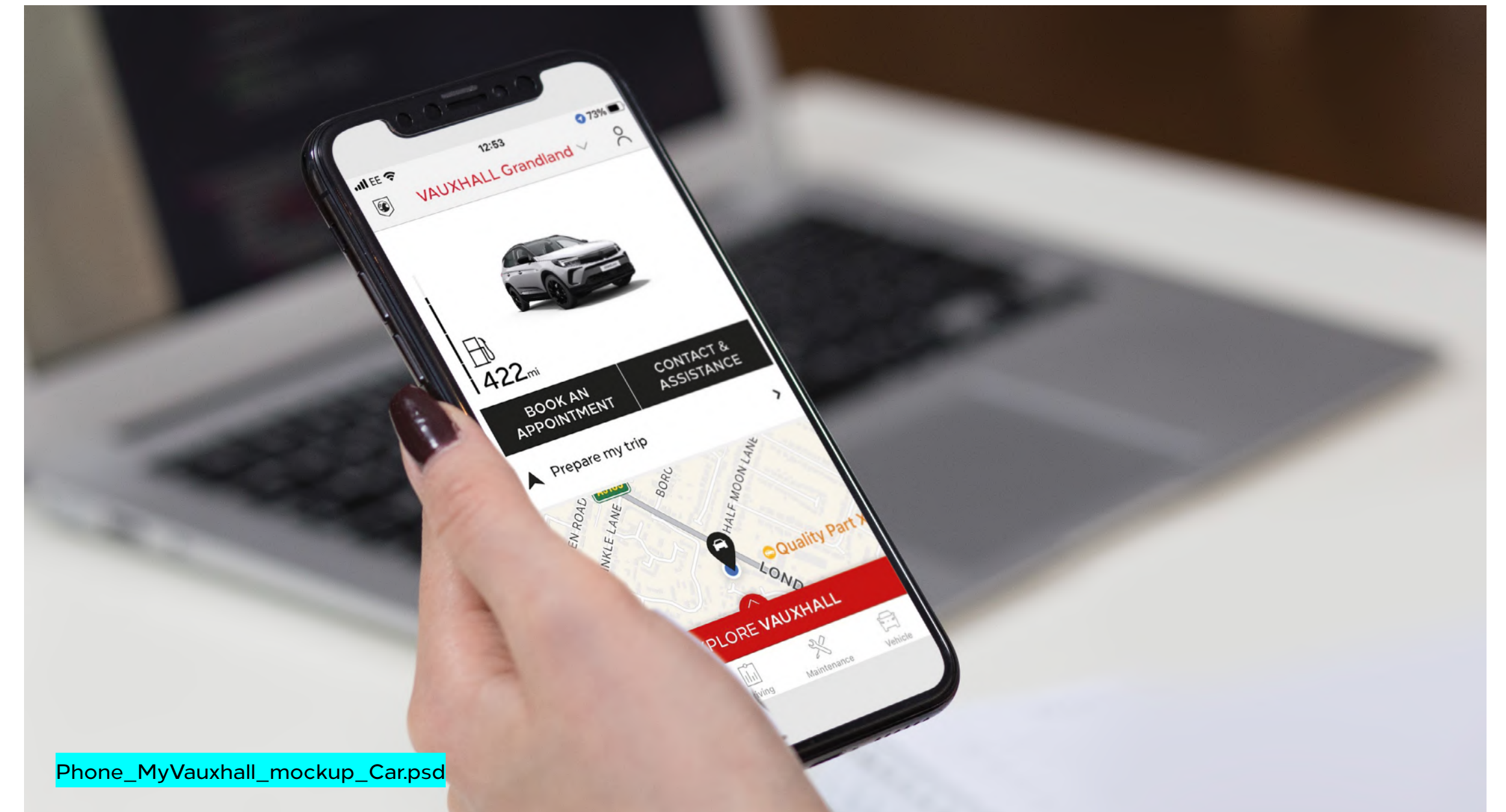

Phone_MyVauxhall_mockup_Car.psd

*Subject to subscription – after you have taken delivery of your vehicle, please subscribe on: connect.vauxhall.co.uk **via MyVauxhall App. †Standard on models with Satellite Navigation only. Additional terms and conditions apply to connected services, including customer acceptance of location sharing prior to activation.

For more information visit vauxhall.co.uk/discover/myvauxhall.html

Comfort and convenience

Model specific features/options	Design	Design Electric	Corsa YES	Corsa Electric YES	GS	GS Electric	Ultimate	Ultimate Electric
Interior convenience								
Reach and rake adjustable steering	●	●	●	●	●	●	●	●
Steering wheel audio/phone/cruise controls	●	●	●	●	●	●	●	●
60/40 split folding rear seats	●	●	●	●	●	●	●	●
Rain-sensitive windscreen wipers	●	●	●	●	●	●	●	●
Automatic anti-dazzle rear-view mirror	●	●	●	●	●	●	●	●
Front centre armrest with storage					●	●	●	●
Keyless start		●		●		●		
Keyless entry and start						●**	●	●
Heating and ventilation								
Air conditioning with air recirculation facility	●		●					
Electronic climate control		●		●	●	●	●	●
Winter Pack (heated seats and heated steering wheel) - includes front centre armrest with storage					£350*	£350*	●	●
Interior lighting								
LED ambient lighting						●	●	●
Interior styling								
Alloy-effect sports pedals					auto only	●	auto only	
Black headliner					●	●	●	●
Exterior convenience								
Fixed panoramic glass sunroof							£500*	£500*
Electrically adjustable/heated door mirrors					●	●	●	●
Electrically folding door mirrors					●	●	●	●

*Optional at extra cost including VAT. **Electric models only.

Safety and security

Model specific features/option	Design	Design Electric	Corsa YES	Corsa Electric YES	GS	GS Electric	Ultimate	Ultimate Electric
Airbags								
Driver's and front passenger's airbag	●	●	●	●	●	●	●	●
Front seat side-impact and full-size curtain airbags	●	●	●	●	●	●	●	●
Braking								
Hill start assist – holds the vehicle steady for two seconds on slopes with a gradient of over 3% after the brake pedal is released	●	●	●	●	●	●	●	●
Safety								
Deactivation switch for front passenger's airbag	●	●	●	●	●	●	●	●
ISOFIX child seat mountings incorporating top tether anchor points located on outer rear seats (does not include child seat)	●	●	●	●	●	●	●	●
Provision for spare wheel fitment – spare wheel is Retailer-fit, deletes emergency tyre inflation kit	£20*				£20*		£20*	
Security								
Locking wheel bolts for alloy wheels	●	●	●	●	●	●	●	●
Remote control central locking	●	●	●	●	●	●	●	●
Remote control security alarm system					●	●	●	●

*Optional at extra cost including VAT.



Hill start assist.



ISOFIX child seat mountings.



Remote control central locking.

Styling

Model specific features/options	Design	Design Electric	Corsa YES	Corsa Electric YES	GS	GS Electric	Ultimate	Ultimate Electric
Exterior styling								
Body-colour door handles, front and rear bumpers	●	●	●	●	●	●	●	●
Black door mirror housings	●	●	●	●	●	●	●	●
Body-colour roof and A-pillars	●	●	●	●	No-cost	No-cost	No-cost	No-cost
Black lower side window mouldings	●	●	●	●	●	●	●	●
Black roof and A-pillars			●	●	●	●	●	●
Chrome-effect Griffin logo and Black vizer frame	●	●	●	●				
Black Griffin logo and vizer frame					●	●	●	●
Sports front and rear body styling					●	●	●	●
High gloss black B-pillars					●	●	●	●
Chrome-effect exhaust tailpipe extension					●*		●*	
Dark-tinted rear side and tailgate windows					●	●	●	●
Ultimate badging and sill plates							●	●

*Available on 130PS models only.



Black Griffin logo and vizer frame.



Black roof and dark-tinted rear windows.



Rear Styling.

Exterior colours

Arctic White (POWP)*
Brilliant paint



VX_COR_e_34340.tif

Crystal Silver (MOZR)**
Two-coat metallic paint £600



VX_COR_e_34361.tif

Carbon Black (M09V)**
Two-coat metallic paint £600



VX_COR_e_34339.tif

Crimson Red (MOPQ)**
Two-coat premium metallic paint £700



VX_COR_e_34341.tif

Graphic Grey (POSD)**
Two-coat premium metallic paint £700



VX_COR_e_34338.tif

Record Red (M01N)***
Two-coat premium metallic paint £700



VX_COR_RED-EDITION-Mockup.psd

The colours reproduced may vary slightly from the actual paint colour. As a result they should be used as a guide only. Your Vauxhall Retailer has a comprehensive display of our paint samples.

Please note, vehicles illustrated are not model specific and are for illustrative purposes only.

*Standard exterior paint. **Optional at extra cost including VAT. ***Exclusive for the Corsa Electric YES/Corsa YES vehicles only.

PureEnergy – Electric

Single-speed electronic drive selector

As the motor is an all-electric single-speed drive unit, there is no need for multiple gears. Instead, the shifter lets the driver select from the following:

- Park • Reverse • Neutral • Drive
- Braking (for increased regenerative braking)

Drive mode selector

The driver can determine the driving style by selecting one of the following modes:

- **Normal:** for a balanced drive that offers a compromise between performance and energy efficiency
- **Sport:** for a dynamic drive with a responsive throttle and the highest top speed and torque
- **ECO:** for maximum range and energy efficiency. The ECO mode deactivates all unnecessary energy-consuming features and reduces the top speed, torque and overall performance

Charging

Corsa Electric is fitted with a 11kW on board charger and is also equipped with a Mode 3 cable as standard. Additional charging accessories are available at extra cost. For more details please consult your local Retailer.

The charging flap's Padlock LED lights up when the cable is correctly plugged in and locked and then acts as a user interface to show the charging status via coloured LED lights:

- **White:** welcome light that helps to light up the area, especially useful in dark conditions
- **Flashing green:** charging in progress
- **Solid green:** charging complete
- **Solid blue:** delayed charging toggled; changes to flashing green when charging commences
- **Solid red:** malfunction

The driver may also choose from two settings:

- **Immediate charging (the standard setting):** Starts charging as soon as the vehicle is docked for charging
- **Delayed charging:** This is especially useful for when cheaper electric rates are desired, e.g. charging at night. Simply enter a charging start time

Please note, EV range assumes that vehicle has been pre-conditioned prior to journey. This function can be accessed either via MyVauxhall App or by using the infotainment system.

Drivetrain – Electric	50kWh	51kWh
CO ₂ emissions	0g/km	
Maximum power	100kW (136PS)	115kW (156PS)
Maximum torque	205Nm (151lb. ft.)	260Nm (192lb. ft.)
Acceleration 0 – 62mph	8.2 sec	8.2 sec
Maximum speed	93mph	
Transmission	Automatic electric drive with fixed gear ratio	
Kerbweight	1544kg	
Service interval	Initial inspection at 8,000 miles/1 year (whichever comes sooner). Thereafter 16,000 miles/2 years (whichever comes sooner)	

Battery	50kWh	51kWh
Battery capacity	50kWh	51kWh
AC on-board charger speed	11kW	
EV range (WLTP high)*	221 miles	248 miles
Energy consumption (Combined low/high)	15.7 – 16.3kWh/100km	14.4 – 14.5kWh/100km
Battery warranty	8 years/100,000 miles/70% capacity	

Charging (Supply)	Socket	Charge Time (0 – 100%)
AC current – Domestic 3 pin socket (2.3kW)	Type 2	21h 45m
AC current – Home wallbox or public charger (7kW)	Type 2	7h 30m
AC current – Public charger (11kW)	Type 2	5h/5h 15m**
DC current – Rapid charger (100kW)	CCS	30m (0 – 80%)

Charging cables	11kW on-board charger
Mode 3, 3-phase 22kW cable	Standard
Mode 2, emergency charging cable	Optional accessory £584

The Corsa Electric is a battery electric vehicle requiring mains electricity for charging. Range data given has been determined according to WLTP test procedure methodology. The figures shown are intended for comparability purposes only and should only be compared to other cars tested to the same technical standard. The range you achieve under real world driving conditions will depend upon a number of factors, including but not limited to: the accessories fitted (pre and post registration); charging frequency; personal driving style; vehicle load and route characteristics; variations in weather; heating/air conditioning; pre-conditioning and battery condition. For more information, contact your local Vauxhall Retailer.

*WLTP preliminary. **5 hours (50kWh)/5 hour 15 minutes (51kWh).

PureEnergy – Petrol

Petrol engines	1.2 (75PS)	1.2 (100PS) Turbo	1.2 (100PS) Turbo Hybrid e-DCT6 auto	1.2 (130PS) Turbo automatic	1.2 (136PS) Turbo Hybrid e-DCT6 auto
Capacity	1199cc	1199cc	1199cc	1199cc	1199cc
Maximum power	75PS (55kW) @ 5750rpm	100PS (74kW) @ 5500rpm	100PS (74kW) @ 5500rpm	130PS (96kW) @ 5500rpm	136PS (100kW) @ 5500rpm
Maximum torque	118Nm (87lb.ft.) @ 2750rpm	205Nm (151lb.ft.) @ 1750rpm	205Nm (151lb.ft.) @ 1750rpm	230Nm (169lb.ft.) @ 1750rpm	230Nm (169lb.ft.) @ 1750rpm
Configuration	3 cylinders, 4 valves per cylinder, double overhead camshafts	3 cylinders, 4 valves per cylinder, double overhead camshafts	3 cylinders, 4 valves per cylinder, double overhead camshafts	3 cylinders, 4 valves per cylinder, double overhead camshafts	3 cylinders, 4 valves per cylinder, double overhead camshafts
Fuel/induction system	Naturally aspirated with Variable Valve Timing. Multi-point sequential fuel injection	Turbocharger. Multi-point sequential fuel injection	Turbocharger. Variable Valve Timing. Common rail direct injection	Turbocharger. Multi-point sequential fuel injection	Turbocharger. Variable Valve Timing. Common rail direct injection
Emission compliance	Euro 6d (6.3)	Euro 6d (6.3)	Euro 6d (6.4)	Euro 6d (6.3)	Euro 6d (6.4)
Service interval	12,500 miles or 1 year (whichever occurs sooner)	12,500 miles or 1 year (whichever occurs sooner)	16,000 miles or 1 year (whichever occurs sooner)	20,000 miles or 1 year (whichever occurs sooner)	16,000 miles or 1 year (whichever occurs sooner)

Performance, fuel economy and emissions	Performance (manufacturer's figures)		Fuel economy mpg (litres/100km) [#]		CO ₂ emissions g/km [#]		Vehicle Excise Duty*		BiK rates from – 2023/24 tax year
	Maximum speed (mph)	Acceleration 0 – 62mph (sec)	Combined Low	Combined High	Combined Low	Combined High	First year rate	Standard rate	
1.2 (75PS)	108	13.2	51.4 (5.5)	52.3 (5.4)	121	123	£220	£190	29%
1.2 (100PS) Turbo	120	9.9	53.3 (5.3)	54.3 (5.2)	117	120	£220	£190	28%
1.2 (100PS) Turbo auto	119	10.8	51.4 (5.5)	51.4 (5.5)	125	125	£220	£190	30%
1.2 (100PS) Turbo Hybrid e-DCT6 auto	116	10.7	61.4 (4.6)	62.8 (4.5)	102	104	£185	£190	25%
1.2 (130PS) Turbo auto	130	8.7	49.6 (5.7)	49.6 (5.7)	127	127	£220	£190	30%
1.2 (136PS) Turbo Hybrid e-DCT6 auto	133	8.6	60.1 (4.7)	60.1 (4.7)	106	106	£185	£190	26%

[#]Figures shown are for comparison purposes and should only be compared to the fuel consumption and CO₂ values of other cars tested to the same technical standard. The fuel consumption achieved, and CO₂ produced, in real world conditions will depend upon a number of factors including, but not limited to: the accessories fitted (pre and post registration); variations in weather; driving styles and vehicle load. The WLTP (Worldwide Harmonised Light Vehicles Test Procedure) is used to measure fuel consumption and CO₂ figures. The CO₂ figures display a range to reflect the highest value for the highest emitting version with all available options added, through to a minimum value to represent the lowest emitting version in standard specification.

*Correct at time of publication.

Specifications

Transmissions

Five-speed manual gearbox

Petrol engine: 1.2 (75PS)

Six-speed manual gearbox

Petrol engine: 1.2 (100PS) Turbo

Eight-speed automatic transmission

Petrol engines: 1.2 (100/130PS) Turbo

This transmission enables increased drive comfort with improved fuel economy and features a manual shifting mode. For a more engaging drive, the driver can select gears using the shift paddles located on the steering wheel.

Drive mode selector (auto-only)

The driver can determine the driving style by selecting one of the following modes:

- **Normal:** for a balanced drive that offers a compromise between performance and energy efficiency
- **Sport:** for a dynamic drive with a responsive throttle and the highest top speed and torque
- **ECO:** for maximum range and energy efficiency. The ECO mode deactivates all unnecessary energy-consuming features and reduces the top speed, torque and overall performance

Drive mode selector (manual-only)

- **Sport:** available with the six-speed manual transmission featuring sound enhancement as well as a more responsive throttle and steering wheel

Hybrid e-DCT6 auto

1.2-litre petrol engine paired with a new six-speed dual clutch automatic transmission and a 28hp electric motor.

Permanent magnet synchronous electric motor is integrated into the gearbox and produces peak power of 21kW (28hp) and maximum torque of 55Nm.

During deceleration from higher constant speeds, the petrol engine stops and the e-motor acts as a generator to recharge the hybrid system's 48v battery.

Under low torque requirements the e-motor allows short distances to be driven on electric power alone (e.g. when manoeuvring or under 18mph in city traffic). It also assists the petrol engine under acceleration, such as when driving from standstill.

Steering

- Speed-sensitive power-assisted steering

Brakes

- Electronic Stability Programme (ESP)
- Traction control
- Drag torque control
- Anti-lock Braking System (ABS)
- Electronic brakeforce distribution
- Emergency brake assist
- Cornering brake control
- Straight line stability control

1.2 (75PS) Design/GS

- Front ventilated discs: 356mm diameter
- Rear drums: 203mm diameter

1.2 (100PS) Design/Corsa YES/GS

- Front ventilated discs: 381mm diameter
- Rear drums: 203mm diameter

1.2 (100/130PS) Design/GS/Ultimate (auto only)

- Front ventilated discs: 381mm diameter
- Rear discs: 356mm diameter

Fuel tank capacity

- 45 litres

Exterior dimensions – mm (inches)	Corsa	Corsa Electric
Length	4060 (159.8)	4060 (159.8)
Width (with mirrors)	1960 (77.2)	1960 (77.2)
Height	1433 (56.4)	1433 (56.4)
Wheelbase	2538 (99.9)	2538 (99.9)
Loadspace dimensions – mm (inches)	Corsa	Corsa Electric
Maximum length behind rear seats	885 (34.8)	885 (34.8)
Maximum length rear seats folded	1697 (66.8)	1697 (66.8)
Maximum width	867 (34.1)	867 (34.1)
Maximum height	574 (22.5)	574 (22.5)
Luggage capacities – Litres (cu.ft.)	Corsa	Corsa Electric
Rear seats up (under luggage compartment cover)	309 (10.9)	267 (9.4)
Rear seats folded (to roof)	1118 (39.4)	1081 (38.1)
Weights and towing data – kg	Gross vehicle weight	Maximum towing weights. Trailer with brakes (without brakes)
1.2 (75PS)	1550	500 (500)
1.2 (100PS) Turbo	1620	1200 (580)
1.2 (100PS) Turbo auto	1645	1200 (610)
1.2 (100PS) Turbo Hybrid e-DCT6 auto	1690	1200 (423)
1.2 (130PS) Turbo auto	1650	1200 (610)
1.2 (136PS) Turbo Hybrid e-DCT6 auto	1690	1200 (423)

Please note: Gross vehicle weight is the total permissible weight of the vehicle including passengers and their luggage. The maximum roof rack loading should not exceed 70kg. The maximum towing weights are based on the ability of the car, with two occupants of 75kg each, to restart on a 12% gradient, which is approximately 1 in 8.3, at sea level. The permitted trailer load applies up to the specified incline and up to an altitude of 1000 metres above sea level. The permissible gross train weight decreases by 10% for every 1000 metres of additional altitude. At altitudes above 1500 metres, the engine output may drop with a corresponding reduction in towing capability. Any extra weight, such as luggage or additional passengers, should be deducted from the maximum towing weight. With a trailer fully loaded, maximum noseweight should not exceed 55kg. Always fit Vauxhall towing attachments and accessories available from your Vauxhall Retailer. They are designed specifically for Vauxhall models and carry a 12-month guarantee. During trailer towing do not exceed a maximum speed of 60mph. This speed limit is also applicable in countries with higher permitted speeds for trailer-vehicle combinations. Pay attention to the local speed limits. For trailers with low driving stability and caravans the use of an oscillation damper is strongly recommended.

Company car driver and fleet information

Benefit in kind company car taxation*

The car benefit charge will be the car's list price (including VAT, options and accessories fitted, delivery to Retailer and number plates, but excluding Vehicle Excise Duty and new vehicle first registration fee) multiplied by the percentage charge for the CO₂ emissions band in which the car falls (see table opposite). Multiply this figure by your personal income tax rate (20%** for Basic Rate, 40%** for Higher Rate) to calculate your annual benefit in kind tax liability.

Generic example:

ELECTRIC vehicle: 0g/km CO₂

On-the-road RRP	£27,305.00
Deduct: Vehicle Excise Duty	£0.00
New vehicle first registration fee	-£55.00
Effective list price	£27,250.00
Add: Optional two-coat metallic paint	£600.00
List price for tax purposes (P11D value)	£27,850.00
Car benefit charge 2023 – 24 tax year (2%)	£557.00
Benefit in kind tax liability	
Basic Rate (20%) tax payer	£111.40
Higher Rate (40%) tax payer	£222.80

*Please note this Price Guide provides taxation information as a guide only. Vauxhall does not provide taxation guidance. Drivers should always take professional advice on their own tax position.

**Excludes residents of Scotland.

BiK for Scottish Residents

Effective 6 April 2018 the Scottish Government have introduced their own BiK taxation structure. This only applies to Company Car Drivers that are Scottish taxpayers. HMRC will determine whether or not an individual is a Scottish taxpayer based on where their main place of residence is.

The BiK rates for Scotland are:

- Over £12,570 – £14,732 Starter Rate 19%
- Over £14,732 – £25,688 Basic Rate 20%
- Over £25,688 – £43,662 Intermediate Rate 21%
- Over £43,662 – £150,000 Higher Rate 41%
- Above £150,000 Top Rate 46%

To calculate your own personal liability, click the link [Vauxhall BiK Tool](#)

CO ₂ (g/km)	Electric range (miles)	% 2024 – 25 tax year
0	-	2%
1 – 50	130+	2%
1 – 50	70 – 129	5%
1 – 50	40 – 69	8%
1 – 50	30 – 39	12%
1 – 50	<30	14%
51 – 54	-	15%
55 – 59	-	16%
60 – 64	-	17%
65 – 69	-	18%
70 – 74	-	19%
75 – 79	-	20%
80 – 84	-	21%
85 – 89	-	22%
90 – 94	-	23%
95 – 99	-	24%
100 – 104	-	25%
105 – 109	-	26%
110 – 114	-	27%
115 – 119	-	28%
120 – 124	-	29%
125 – 129	-	30%
130 – 134	-	31%
135 – 139	-	32%
140 – 144	-	33%
145 – 149	-	34%
150 – 154	-	35%
155 – 159	-	36%
160+	-	37%

Vehicle Excise Duty†

The amount of Vehicle Excise Duty (road fund licence) payable on new cars varies depending on the level of carbon dioxide (CO₂) emissions produced by the vehicle. CO₂ emissions are measured in grams per kilometre (g/km) travelled and divided into 13 charging bands shown in the table below.

A 'first year rate' of Vehicle Excise Duty is payable on all new cars and in subsequent years the amount payable reverts to a different rate. Also, for vehicles with a list price over £40,000, including factory-fitted options, an additional £410 is payable for five years after registration.

VED Band	CO ₂ (g/km)	First year rate Petrol/ Diesel	First year rate Hybrid/ Electric
A	0	£0	£0
B	1 – 50	£10	£0
C	51 – 75	£30	£20
D	76 – 90	£135	£125
E	91 – 100	£175	£165
F	101 – 110	£195	£185
G	111 – 130	£220	£210
H	131 – 150	£270	£260
I	151 – 170	£680	£670
J	171 – 190	£1,095	£1,085
K	191 – 225	£1,650	£1,640
L	226 – 255	£2,340	£2,330
M	Over 255	£2,745	£2,735

†Correct at time of issue.

Fleet Toolbox

The Fleet Toolbox has a host of useful calculators, comparators, interactive listings and information.

Click the link for more information

[Vauxhall Fleet Tool Box](#)

Contact Vauxhall Fleet

Please contact one of our dedicated sales teams who will be happy to help with your particular enquiry.

Fleet Decision Makers

Depending on the size of your fleet of vehicles, we have a dedicated team to handle your enquiries. The lines are open Monday to Friday excluding Bank Holidays.

1 – 24 vehicles

Call: 0203 885 4560 (8:30am – 5:00pm)

Email: enquiries@stellantis-fleet.co.uk

50+ vehicles

Call: 0203 885 4562 (8:30am – 5:00pm)

Email: enquiries@vauxhallfleet.co.uk

Special Vehicles (Police, Fire and Ambulance)

Email: psvo@stellantis.com

For more information visit vauxhall.co.uk/fleet

Further information

On-the-road prices

To eliminate uncertainty about hidden costs when buying a new car, Vauxhall publishes on-the-road recommended retail prices (RRP) and these are shown in the pricing tables within this price guide. These prices include VAT, number plates and delivery to Retailer of £900.00 (including £150.00 VAT), 12 months' Government Vehicle Excise Duty and the DVLA new vehicle first registration fee of £55.00.*

Please note: The on-the-road recommended retail price (RRP) does not include fuel supplied by the Retailer, motor insurance or any other goods or services supplied by agreement between the Retailer and the customer.

Price protection

Order a new Vauxhall for build in the current model year (as confirmed by your Retailer) for delivery no more than three months in advance and the price you are quoted is the price you pay. This is irrespective of any subsequent price rises between placing your order and delivery of your new car, but you must take delivery as soon as the car is available. Please note: Vauxhall Motors Limited is not liable for price adjustments caused by Government changes in the rate of VAT (currently 20%), Vehicle Excise Duty, DVLA new vehicle first registration fee or by any other applicable legislation or regulations.

Customer Care Commitment

For added peace of mind, Vauxhall has an innovative Customer Care Commitment that offers the following:

- Three-year vehicle warranty consisting of a one year/unlimited mileage manufacturer's warranty and a second and third year manufacturer's warranty with a 60,000 miles limitation

- Vauxhall Assistance for 12 months from first registration
- Six years' body panel anti-perforation warranty

Please note: Warranty is only available on vehicles sourced from Vauxhall Motors Limited. Terms and conditions apply – please see your Vauxhall Retailer for details.

Vauxhall Assistance

Vauxhall Assistance is provided automatically with every new Vauxhall for 12 months from first registration and covers everything from accident assistance, roadside recovery and 'at home' service to flat tyres. For even more peace of mind, on fully electric models, the cover is extended** to 3 years. Even more reason for you to stay calm and let us take care of everything should the need arise. With Vauxhall Assistance help is literally just a free† phone call away, 24 hours a day, 365 days a year!

LEASYS

Leasys UK

Leasys is the proud Business Contract Hire partner of Vauxhall and consequently, can provide quick vehicle delivery to keep your business mobile. Specialised in Medium to Long-Term Leasing options and Fleet Management solutions for businesses of all sizes, [Leasys](#) lead mobility by offering sustainable and innovative solutions designed around customers, for a best-in-class experience. Their team of experts can personally support you and provide dedicated consultation. [Leasys](#) is equally owned by Stellantis and Crédit Agricole Consumer Finance and is a member of the British Vehicle Rental and Leasing Association (BVRLA). For further information, please contact your local Vauxhall Retailer or visit [leasys.com/uk](#)

In the event of an accident

Vauxhall Accident Management helps keep you mobile following an accident. Benefits include vehicle recovery, Vauxhall-approved repairs and contacting your insurer. For more details, visit [vauxhall.co.uk/AccidentManagement](#)

Vauxhall Flexcare – Service Plans and Extended Warranty

Designed for your peace of mind. A collection of extended warranty and service plans to match the way you drive.

Extended Warranty

An extended warranty for your Vauxhall offers you similar cover for material or manufacturing defects beyond the original warranty period on the vehicle. By choosing an official Vauxhall Extended Warranty, we guarantee that any repairs you need are carried out by Vauxhall trained technicians using genuine Vauxhall parts.

Service Plans

There's no need to worry about budgeting for your next service. Simply take out a Vauxhall Fixed Price Service Care Plan. You can then focus on the more important things in life, knowing your servicing costs are taken care of. For more information, click on the link below or call us on **0345 600 2065**. See [vauxhall.co.uk/discover/here-for-you.html](#)

Vauxhall Service Club

A world of servicing, repair and accessory benefits with Vauxhall Service Club is available for all Vauxhall owners, and it's free to join via the MyVauxhall app (terms and conditions apply). For a list of benefits and details on how to join visit: [vauxhall.co.uk/serviceclub](#)

Vauxhall Insurance with added reassurance

Join the family or find out more about Vauxhall Insurance Services by contacting our insurance team on **0330 678 1130**††, or visit: [vauxhall.co.uk/offers-finance/insurance.html](#)

Vauxhall Accessories

From the small things that make life easier to the big things that make life exciting – personalise your Vauxhall with Vauxhall Accessories. So what are you looking for? A device holder, roof box, or even splash guards? Whatever it is we've got the solution for you. With our huge accessory range, all tailor-made for your Vauxhall and come with a full year's warranty. For further details visit your local Retailer or see [vauxhall.co.uk/owners/accessories.html](#)

Protecting the environment

Vauxhall's commitment to the environment is demonstrated by our products' many environmental awards. For even more information on Vauxhall's efforts to achieve an environmentally sustainable future, and how to dispose of your end-of-life vehicle, see [vauxhall.co.uk/recycling](#)

For more product information

For further information on the Vauxhall range or location of your nearest Vauxhall Retailer please call **0800 026 0034**. Alternatively, details can be found on our website at [vauxhall.co.uk](#)

VAUXHALL

For more information call **0800 026 0034**

For Fleet enquiries call **0203 476 2268**

Discover the full Vauxhall range at **[vauxhall.co.uk](https://www.vauxhall.co.uk)**

Join us online

The invoice price, including delivery to Retailer, factory-fitted options, accessories fitted by the Retailer and number plates, is subject to VAT. Some feature descriptions in this guide may refer to, and some illustrations may show, optional equipment not included in the standard delivery. The information contained in this guide was accurate at the time of publication. We reserve the right to make changes in design and equipment. Please note that Vauxhall Retailers are not the agents of Vauxhall Motors Limited and are not authorised to bind Vauxhall Motors Limited by any specific or implied undertaking or representation. It is advisable to ensure that your motor insurance policy provides adequate cover for additional fitted options and accessories. The colours in this guide are only approximate actual colours. Illustrated optional equipment is available at extra charge. Availability, technical features and equipment provided on our vehicles can vary by model. For precise information on the equipment provided on our vehicles, please contact your local Vauxhall Retailer.

Price and Specification Guide
3 April 2024 | Model Year 2024B



Astra

Including Electric and Plug-in Hybrid GSe

Contents

To find the information you want use the links below to navigate around the guide:

Models

Prices

Vauxhall PureSense

Vauxhall PureConnect

Comfort and convenience

Safety and security

Styling

Exterior colours

Vauxhall PureEnergy

Specifications

Company car information

Further information

At Vauxhall, we believe great cars are for everyone. We believe technology works best when it's not just smart but is also simple and intuitive. Where everyone can feel the instant excitement of electric; can keep themselves and their loved ones safer on the road; and can stay connected to the things that matter most, simply and easily. We call it Vauxhall Pure Technology. No gimmicks, nothing complicated, just technology that makes driving better, easier and more exciting, for everyone.

Our latest Astra Price and Spec guide outlines the Pure Technology features model by model. Together with all the essential information you need to compare Prices, Technical Information and Specification plus details of our commitment to offer the best in Customer Care.

We're delighted you're considering the purchase of a new Astra and hope this guide will help you make the right choice.



Design



Design Petrol/Plug-in Hybrid.



Design Electric.



16-inch alloy wheel.



18-inch alloy wheel.

Standard features include:

PureSense

- LED headlights and tail lights
- LED daytime running lights
- LED front fog lights
- Automatic lighting control
- High beam assist
- Electronic parking brake
- Front and rear parking distance sensors
- Lane departure warning with lane keep assist
- Speed sign recognition (Petrol/Plug-in Hybrid only)
- Traffic sign recognition (Electric only)
- Driver drowsiness alert
- Forward collision alert (low speed)
- Automatic emergency braking with pedestrian detection
- Adaptive cruise control with intelligent speed adaption
- Eight airbags
- Remote control security alarm system
- Hill start assist
- In-crash braking
- ISOFIX child seat fixings on outer rear seats

PureConnect

- Multimedia Pure Panel Navigation system
 - 10-inch colour touchscreen
 - 10-inch digital instrument cluster
 - AM/FM/DAB digital radio
 - Bluetooth®
 - Natural voice recognition
 - Wireless Apple CarPlay/Android Auto™
 - Front USB connection
- Six speakers
- Vauxhall Connect

Comfort and convenience

- Electronic climate control
- Flat-bottomed steering wheel
- Steering wheel audio/phone/cruise controls
- Illuminated vanity mirrors and rear reading lights
- Reach and rake adjustable steering
- 60/40 split-folding rear seat backs (Hatchback only)
- 40/20/40 split-folding rear seat backs with remote easy-fold facility (Sports Tourer only)
- Flex load floor with luggage restraining nets (pair, Sports Tourer only)
- Rain-sensitive windscreen wipers
- Electrically operated front and rear windows
- Electrically adjustable/heated door mirrors
- Soundproofed insulated windscreen
- Keyless start
- Intelli-Space (Sports Tourer only)
- Emergency tyre inflation kit

Interior

- Driver's seat (six-way adjustable)
- Front passenger's seat (four-way adjustable)
- Black facia with Modene trim inserts
- Instrument panel bar Alexit Grey
- Birdie Grey trim inserts on front doors
- Jet Black Modene seat trim inserts
- Jet Black Modene fabric side bolsters and surrounds

Styling

- Body-colour front and rear bumpers
- 16-inch silver alloy wheels with 205/55 R 16 tyres (Petrol only)
- 18-inch diamond-cut alloy wheels with 215/45 R 18 tyres (Electric only)
- Chrome-effect Griffin logo
- Black vizor frame
- Black lower window moulding

GS



VX_AST_34159.tif

GS Petrol/Plug-in Hybrid.



VX_AST_e_34283.tif

GS Electric.



VX_AST_33740.tif

VX_AST_32866_QOJ.psd



VX_AST_32867_PU2.psd

17-inch alloy wheel. 18-inch alloy wheel (extra cost option).**

VX_AST_e_34294.psd



18-inch alloy wheel.

Features over and above Design:

PureSense

- Traffic sign recognition
- Forward collision alert (all speed)

PureConnect

- Pure Panel Pro digital display
- Intelli-Vision 360° panoramic parking camera

Comfort and convenience

- Dual-zone electronic climate control
- Heated perforated flat-bottomed leather covered steering wheel (leather-effect on Electric model)
- Driver's ergonomic active sports-style seat (AGR approved*)
- Heated front seats
- Paddle shift (excluding manual/Electric)
- Front centre armrest with cup holder
- Centre rear seat armrest and load-through facility
- Flex load floor
- Frameless automatic anti-dazzle rear-view mirror
- Keyless entry and start
- Interior ambient lighting

Interior

- Ergonomic active sports-style driver's seat (eight-way adjustable)
- Black facia with Isabella trim inserts
- Instrument panel bar Liquid Palladium
- Mistral Black trim inserts on front doors
- Jet Black Greta fabric seat trim inserts
- Jet Black Greta side bolsters and surrounds

Styling

- Sports-style front and rear bumpers
- 17-inch black alloy wheels with 225/45 R 17 tyres (Petrol/Plug-in Hybrid only)
- 18-inch black alloy wheels with 215/45 R 18 tyres (Electric only)
- Black Griffin logo and vizor frame
- Dark-tinted rear windows
- Black roof and interior headliner
- Alloy-effect sports pedals (excludes manual transmission)

*AGR (The Campaign for Healthier Backs) is an independent centre of excellence for ergonomics, based in Germany. **For more information see Styling page, click [here](#)

Ultimate



Ultimate Petrol/Plug-in Hybrid.



Ultimate Electric.



18-inch alloy wheel.



18-inch alloy wheel.

Features over and above GS:

PureSense

- IntelliLux adaptive LED® pixel headlights
- Lane change assist with side blind spot alert
- Lane positioning assist
- Rear cross traffic alert
- Semi-autonomous lane change**
- Advanced intelligent speed adaptation**

PureConnect

- Hi-fi with eight speakers (Petrol/Plug-in Hybrid only)
- Intelli-HUD (Head-Up Display)
- Wireless charger for mobile devices

Comfort and convenience

- Heated soundproofed insulated windscreen
- Heated ergonomic active sports-style front seats (AGR approved*)
- Panoramic sunroof
- Power tailgate (Sports Tourer only)

Interior

- Driver's seat
 - 10-way electrically adjustable (Petrol/Plug-in Hybrid only)
 - 8-way electrically adjustable (Electric only)
- Front passenger's seat (eight-way adjustable – Petrol/Plug-in Hybrid only)
- Black facia with high gloss black inserts
- Alcantara interior seat and door trim inserts
- Alcantara side bolsters and surrounds

Styling

- 18-inch diamond-cut alloy wheels with grey inserts and 225/40 R 18 tyres (Petrol/Plug-in Hybrid only)
- 18-inch diamond-cut alloy wheels with 215/45 R 18 tyres (Electric only)
- High gloss black roof rails (Sports Tourer only)

*AGR (The Campaign for Healthier Backs) is an independent centre of excellence for ergonomics, based in Germany. **Not available with manual transmission.

GSe



18-inch alloy wheel.



Features over and above GS:

PureSense

- IntelliLux adaptive LED® pixel headlights
- Lane change assist with side blind spot alert
- Lane positioning assist
- Rear cross traffic alert
- Semi-autonomous lane change
- Advanced intelligent speed adaptation

PureConnect

- Hi-fi with eight speakers
- Intelli-HUD (Head-Up Display)
- Wireless charger for mobile devices

Comfort and convenience

- Heated soundproofed insulated windscreen
- GSe performance heated front seats (AGR approved*)
- Panoramic sunroof
- Power tailgate (Sports Tourer only)

Interior

- Driver's seat (10-way electrically adjustable) with memory function
- Front passenger's seat (eight-way adjustable)
- Black facia with high gloss black inserts
- Instrument panel bar Liquid Palladium
- Alcantara inserts on front doors
- Alcantara seat trim inserts
- Alcantara side bolsters and surrounds

Styling

- Unique GSe front and rear bumpers
- 18-inch gloss black bi-colour diamond-cut alloy wheels with 225/40 R 18 tyres
- High gloss black roof rails (Sports Tourer only)
- GSe badge

*AGR (The Campaign for Healthier Backs) is an independent centre of excellence for ergonomics, based in Germany.

Prices

Electric	LCDV code	Price (£)	VAT (£)	Total (£)	On-the-road RRP (£)	Financial year 2023/24 BiK 20% (£)	WLTP combined CO ₂ (g/km) - LCDV code	Insurance groups
Hatchback								
Design								
Electric Propulsion (156PS) auto	1GO5A5LZIFTOA0D2	30,700.00	6,140.00	36,840.00	37,795.00	12.58	0	26E
GS								
Electric Propulsion (156PS) auto	1GO5A5TZIFTOA0D2	32,658.33	6,531.67	39,190.00	40,145.00	13.36	0	26E
Ultimate								
Electric Propulsion (156PS) auto	1GO5A5TZIFTO40D2	35,254.17	7,050.83	42,305.00	43,260.00	14.40	0	26E
Sports Tourer								
Design								
Electric Propulsion (156PS) auto	1GO5C5LZIFTOA0D2	32,533.33	6,506.67	39,040.00	39,995.00	13.31	0	26E
GS								
Electric Propulsion (156PS) auto	1GO5C5TZIFTOA0D2	34,491.67	6,898.33	41,390.00	42,345.00	14.10	0	26E
Ultimate								
Electric Propulsion (156PS) auto	1GO5C5TZIFTO40D2	37,087.50	7,417.50	44,505.00	45,460.00	15.14	0	27E

WLTP combined CO₂ (g/km) figures are based on a configured vehicle as per LCDV code for UK with no options fitted.

*Provisional fuel consumption and CO₂ figures are determined according to the WLTP test cycle. CO₂ figures, BiK values and RRP pricing shown above are for a standard vehicle without any additional optional equipment. CO₂ figures are used to calculate Vehicle Excise Duty (VED) for the first registration of the vehicle and BiK. The addition of optional extras could increase the certified CO₂ emission output. This in turn may affect the amount of VED payable upon registration, and, for company car drivers, the P11D value and the amount of Benefit in Kind (BiK) tax payable. Figures shown are for comparison purposes and should only be compared to the fuel consumption and CO₂ values of other cars tested to the same technical standard. The fuel consumption achieved, and CO₂ produced, in real world conditions will depend upon a number of factors including, but not limited to: the accessories fitted (pre and post registration); variations in weather; driving styles and vehicle load. The WLTP (Worldwide Harmonised Light Vehicles Test Procedure) is used to measure fuel consumption and CO₂ figures. Full data relating to WLTP test cycles can be found at: www.vauxhall.co.uk/wltp

Please note: On-the-road recommended retail prices (RRP) include number plates and delivery to Retailer of £900.00 (including £150.00 VAT), 12 months' Vehicle Excise Duty and new vehicle first registration fee of £55.00. Excludes fuel and insurance. Company Car Benefit in Kind (BiK) rates are monthly based on the standard pait price.

Prices

Plug-in Hybrid	LCDV code	Price (£)	VAT (£)	Total (£)	On-the-road RRP (£)	Financial year 2023/24 BiK 20% (£)	WLTP combined CO ₂ (g/km) [#] - LCDV code	Insurance groups
Hatchback								
GS								
1.6 (180PS) Turbo/Electric auto	1GO5A5TR8AT0A0D2	30,816.67	6,163.33	36,980.00	37,935.00	75.76	28	26E
Ultimate								
1.6 (180PS) Turbo/Electric auto	1GO5A5TR8AT040D2	33,412.50	6,682.50	40,095.00	41,050.00	81.99	29	28E
GSe								
1.6 (225PS) Turbo/Electric auto	1GO5A5ZR7AT0A0D2	34,037.50	6,807.50	40,845.00	41,800.00	83.49	30	31E
Sports Tourer								
GS								
1.6 (180PS) Turbo/Electric auto	1GO5C5TR8AT0A0D2	32,650.00	6,530.00	39,180.00	40,135.00	80.16	28	27E
Ultimate								
1.6 (180PS) Turbo/Electric auto	1GO5C5TR8AT040D2	35,412.50	7,082.50	42,495.00	43,450.00	86.79	30	29E
GSe								
1.6 (225PS) Turbo/Electric auto	1GO5C5ZR7AT0A0D2	35,870.83	7,174.17	43,045.00	44,000.00	87.89	30	31E

WLTP combined CO₂ (g/km) figures are based on a configured vehicle as per LCDV code for UK with no options fitted.

[#]Provisional fuel consumption and CO₂ figures are determined according to the WLTP test cycle. CO₂ figures, BiK values and RRP pricing shown above are for a standard vehicle without any additional optional equipment. CO₂ figures are used to calculate Vehicle Excise Duty (VED) for the first registration of the vehicle and BiK. The addition of optional extras could increase the certified CO₂ emission output. This in turn may affect the amount of VED payable upon registration, and, for company car drivers, the P11D value and the amount of Benefit in Kind (BiK) tax payable. Figures shown are for comparison purposes and should only be compared to the fuel consumption and CO₂ values of other cars tested to the same technical standard. The fuel consumption achieved, and CO₂ produced, in real world conditions will depend upon a number of factors including, but not limited to: the accessories fitted (pre and post registration); variations in weather; driving styles and vehicle load. The WLTP (Worldwide Harmonised Light Vehicles Test Procedure) is used to measure fuel consumption and CO₂ figures. Full data relating to WLTP test cycles can be found at: www.vauxhall.co.uk/wltp

Please note: On-the-road recommended retail prices (RRP) include number plates and delivery to Retailer of £900.00 (including £150.00 VAT), 12 months' Vehicle Excise Duty and new vehicle first registration fee of £55.00. Excludes fuel and insurance. Company Car Benefit in Kind (BiK) rates are monthly based on the standard pait price.

Prices

Petrol	LCDV code	Price (£)	VAT (£)	Total (£)	On-the-road RRP (£)	Financial year 2023/24 BiK 20% (£)	WLTP combined CO ₂ (g/km) [#] - LCDV code	Insurance groups
Hatchback								
Design								
1.2 (110PS) Turbo	1GO5A5LL5KTOA0D2	21,495.83	4,299.17	25,795.00	26,970.00	129.03	123	16E
1.2 (130PS) Turbo	1GO5A5LM6KT0A0D2	21,995.83	4,399.17	26,395.00	27,570.00	131.93	123	17E
1.2 (130PS) Turbo auto	1GO5A5LM61T0A0D2	23,245.83	4,649.17	27,895.00	29,070.00	143.98	125	18E
1.2 (136PS) Turbo Hybrid e-DCT6 auto	1GO5A5LJHWT0A0D2	24,079.17	4,815.83	28,895.00	30,035.00	129.11	106	20E
GS								
1.2 (130PS) Turbo	1GO5A5TM6KT0A0D2	23,908.33	4,781.67	28,690.00	29,865.00	147.95	125	19E
1.2 (130PS) Turbo auto	1GO5A5TM61T0A0D2	25,158.33	5,031.67	30,190.00	31,365.00	155.45	128	18E
1.2 (136PS) Turbo Hybrid e-DCT6 auto	1GO5A5TJHWT0A0D2	25,991.67	5,198.33	31,190.00	32,330.00	139.06	109	20E
Ultimate								
1.2 (130PS) Turbo	1GO5A5TM6KT040D2	26,504.17	5,300.83	31,805.00	32,980.00	163.53	128	20E
1.2 (130PS) Turbo auto	1GO5A5TM61T040D2	27,754.17	5,550.83	33,305.00	34,530.00	176.73	131	20E
1.2 (136PS) Turbo Hybrid e-DCT6 auto	1GO5A5TJHWT040D2	28,587.50	5,717.50	34,305.00	35,470.00	158.42	112	21E

WLTP combined CO₂ (g/km) figures are based on a configured vehicle as per LCDV code for UK with no options fitted.

[#]Provisional fuel consumption and CO₂ figures are determined according to the WLTP test cycle. CO₂ figures, BiK values and RRP pricing shown above are for a standard vehicle without any additional optional equipment. CO₂ figures are used to calculate Vehicle Excise Duty (VED) for the first registration of the vehicle and BiK. The addition of optional extras could increase the certified CO₂ emission output. This in turn may affect the amount of VED payable upon registration, and, for company car drivers, the P11D value and the amount of Benefit in Kind (BiK) tax payable. Figures shown are for comparison purposes and should only be compared to the fuel consumption and CO₂ values of other cars tested to the same technical standard. The fuel consumption achieved, and CO₂ produced, in real world conditions will depend upon a number of factors including, but not limited to: the accessories fitted (pre and post registration); variations in weather; driving styles and vehicle load. The WLTP (Worldwide Harmonised Light Vehicles Test Procedure) is used to measure fuel consumption and CO₂ figures. Full data relating to WLTP test cycles can be found at: www.vauxhall.co.uk/wltp

Please note: On-the-road recommended retail prices (RRP) include number plates and delivery to Retailer of £900.00 (including £150.00 VAT), 12 months' Vehicle Excise Duty and new vehicle first registration fee of £55.00. Excludes fuel and insurance. Company Car Benefit in Kind (BiK) rates are monthly based on the standard paint price.

Prices

Petrol	LCDV code	Price (£)	VAT (£)	Total (£)	On-the-road RRP (£)	Financial year 2023/24 BiK 20% (£)	WLTP combined CO ₂ (g/km) [#] - LCDV code	Insurance groups
Sports Tourer								
Design								
1.2 (110PS) Turbo	1GO5C5LL5KT0A0D2	23,329.17	4,665.83	27,995.00	29,170.00	144.48	125	16E
1.2 (130PS) Turbo	1GO5C5LM6KT0A0D2	23,829.17	4,765.83	28,595.00	29,770.00	147.48	126	18E
1.2 (130PS) Turbo auto	1GO5C5LM61T0A0D2	25,079.17	5,015.83	30,095.00	31,270.00	154.98	128	19E
1.2 (136PS) Turbo Hybrid e-DCT6 auto	1GO5C5LJHWT0A0D2	25,912.50	5,182.50	31,095.00	32,235.00	138.65	108	19E
GS								
1.2 (130PS) Turbo	1GO5C5TM6KT0A0D2	25,741.67	5,148.33	30,890.00	32,065.00	158.95	129	19E
1.2 (130PS) Turbo auto	1GO5C5TM61T0A0D2	26,991.67	5,398.33	32,390.00	33,565.00	172.00	130	19E
1.2 (136PS) Turbo Hybrid e-DCT6 auto	1GO5C5TJHWT0A0D2	27,825.00	5,565.00	33,390.00	34,555.00	154.31	111	20E
Ultimate								
1.2 (130PS) Turbo	1GO5C5TM6KT040D2	28,504.17	5,700.83	34,205.00	35,430.00	181.38	131	19E
1.2 (130PS) Turbo auto	1GO5C5TM61T040D2	29,754.17	5,950.83	35,705.00	36,930.00	189.13	133	20E
1.2 (136PS) Turbo Hybrid e-DCT6 auto	1GO5C5TJHWT040D2	30,587.50	6,117.50	36,705.00	37,870.00	169.22	114	21E

WLTP combined CO₂ (g/km) figures are based on a configured vehicle as per LCDV code for UK with no options fitted.

[#]Provisional fuel consumption and CO₂ figures are determined according to the WLTP test cycle. CO₂ figures, BiK values and RRP pricing shown above are for a standard vehicle without any additional optional equipment. CO₂ figures are used to calculate Vehicle Excise Duty (VED) for the first registration of the vehicle and BiK. The addition of optional extras could increase the certified CO₂ emission output. This in turn may affect the amount of VED payable upon registration, and, for company car drivers, the P11D value and the amount of Benefit in Kind (BiK) tax payable. Figures shown are for comparison purposes and should only be compared to the fuel consumption and CO₂ values of other cars tested to the same technical standard. The fuel consumption achieved, and CO₂ produced, in real world conditions will depend upon a number of factors including, but not limited to: the accessories fitted (pre and post registration); variations in weather; driving styles and vehicle load. The WLTP (Worldwide Harmonised Light Vehicles Test Procedure) is used to measure fuel consumption and CO₂ figures. Full data relating to WLTP test cycles can be found at: www.vauxhall.co.uk/wltp

Please note: On-the-road recommended retail prices (RRP) include number plates and delivery to Retailer of £900.00 (including £150.00 VAT), 12 months' Vehicle Excise Duty and new vehicle first registration fee of £55.00. Excludes fuel and insurance. Company Car Benefit in Kind (BiK) rates are monthly based on the standard paint price.

PureSense

Model specific features	Design	Design Electric	GS	GS Plug-in Hybrid/Electric	Ultimate	Ultimate Plug-in Hybrid/Electric	GSe Plug-in Hybrid
Driver assistance							
Automatic emergency braking with pedestrian detection	●	●	●	●	●	●	●
Adaptive cruise control with intelligent speed adaptation	●	●	●	●	●	●	●
Driver drowsiness alert	●	●	●	●	●	●	●
Lane departure warning with lane keep assist	●	●	●	●	●	●	●
Electronic parking brake	●	●	●	●	●	●	●
Front and rear parking distance sensors	●	●	●	●	●	●	●
Speed sign recognition	●	●	●	●	●	●	●
Extended traffic sign recognition		●	●	●	●	●	●
Intelli-Vision 360° panoramic parking camera			●	●	●	●	●
Intelli-HUD (Head-Up Display)					●	●	●
Intelli-Drive 2.0 – Semi-automated lane change assist with side blind spot alert/Advanced intelligent speed adaptation/Lane positioning assist/Rear cross traffic alert					auto only	●	●
Exterior lighting							
LED headlights, front fog and tail lights	●	●	●	●	●	●	●
High beam assist	●	●	●	●	●	●	●
LED daytime running lights	●	●	●	●	●	●	●
Automatic lighting control	●	●	●	●	●	●	●
IntelliLux adaptive LED® pixel headlights					●	●	●

PureConnect

Pure Panel digital display

Pure Panel technology makes driving more intuitive, with a flowing design that presents the information you need. With a 10-inch infotainment colour touchscreen and 10-inch digital instrument cluster right in front of you, you can stay focused on the road ahead.

- GS, Ultimate and GSe models feature the Pure Panel Pro digital display with edge-to-edge glass finish.

EV information display

- Powerflow display – Informs drivers on the current state of charge and what is being used as the power source, petrol or electric
- Charge display – displays an image of the charge port with the corresponding LED charge indication lights
- e-Save – enables the driver to determine how much battery energy needs to be conserved to ensure that the vehicle reaches its destination when in a zero emission zone
There are three options:
 - 6 mile range reserve
 - 12 mile range reserve
 - Maximum reserve
- Statistics – The Statistics display the average consumption data over a period of time using colour coded graphs
- **Green:** Energy recovered by braking phases and partial recharging by the petrol engine (kWh/mile)
- **Blue:** Energy consumed by the vehicle directly by the battery (kWh/mile)
- **Orange:** Fuel consumption (mpg)

Digital instrumentation

- Digital speedometer and rev counter
- Satellite Navigation display
- Digital fuel gauge with low fuel level warning light
- Digital water temperature gauge with warning light
- Shift-up/down indication light – Indicates when to change gear for optimum fuel economy

Driver information display

(centrally located in digital instrument cluster)

- Total mileage
- Service-due indicator
- Oil life
- Tyre pressure monitoring system

Multi-function trip computer

(displayed on digital instrument cluster)

- Trip mileage
- Vehicle range based on remaining fuel
- Average speed
- Average fuel economy
- Instantaneous fuel economy
- Driving time

Digital central fascia display

- Audio information
- Digital clock with automatic RDS time adjustment
- Outside air temperature with ice warning function

Infotainment

Onboard features

- Satellite navigation system with natural voice recognition
- 2D/3D street level mapping
- European coverage
- Points-of-interest search
- Map updates via USB
- DAB Digital radio
- RDS with Traffic Programme
- AM/FM stereo radio with 36 station presets
- Six speakers (Ultimate/GSe models – eight)
- Customizable screen adaption with enhanced profile management and driver recognition
- Heating, Ventilation and Air Conditioning (HVAC) user interface
- Over-the-air updates (e.g. for software)
- WiFi updates (e.g. content download)

The following features are standard across the entire Astra range.

Media connections

- USB connection with iPod control
- Bluetooth® A2DP audio streaming (Advanced Audio Distribution Profile)

Mobile phone portal

- Bluetooth® connectivity
- Vehicle microphone
- Handsfree calls via steering wheel controls
- Phone book access – Contacts/last calls/missed calls etc are mirrored on the display and are easily navigated using the touchscreen (features dependent on mobile phone)
- SMS read out and reply

Additional features

- Steering wheel mounted audio controls
- Shark fin aerial

Drive Smart

- Live navigation provided by TomTom®
- Real time traffic news
- Parking prices and availability
- Weather information
- Natural voice recognition
- Fuel prices
- Charging station search
- Quick search for addresses and points of interest
- Road safety alerts

Vauxhall Connect



Safety

The more you know, the safer your journey – that's why our smart tech and connected services keep you constantly updated on what's going on inside and outside your vehicle.

Peace of mind

- Emergency call (SOS e-call)
- Breakdown call (b-call)



e-Remote control

Want seamless charging and added levels of comfort? Use e-Remote to schedule charging times, keep an eye on your range and even pre-set your vehicle's cabin temperature before you get in.

Convenience

- E-remote control (Plug-in Hybrid/ Electric only)**
- Remote check of battery level, programming and charge management
- Pre-conditioning of vehicle temperature

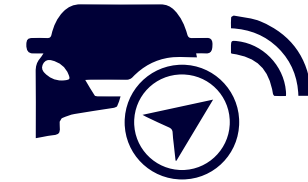

Live navigation plus†

With real-time directions and traffic information from the leading European GPS provider, TomTom®, every journey will be a breeze.

- TomTom® services
- Real time traffic news
- Parking prices and availability
- Weather forecast on your journey
- Natural voice control
- Fuel prices at petrol stations
- Search for charging stations
- Quick search for points of interest
- Road safety alerts



Maintenance

Connected services are here for you – even when things go wrong. Our Intelligent Telemaintenance service monitors the key functions of your vehicle – and notifies you as soon as something needs attention.

- Vehicle status and information**
- Maintenance alerts, fuel level, average fuel consumption and mileage

Vauxhall Connect* is the smart way to stay connected while on the road. Innovative technology systems and related services keep our drivers safe and provide an exciting, efficient yet safe trip.

Download
MyVauxhall now!



Explore MyVauxhall

Ready to make life easier? Meet MyVauxhall – your one-stop shop for everything Vauxhall. Plan journeys from the comfort of your armchair. View your next scheduled service, book a vehicle repair, access your handbook and much more!

Also if you drive an electric vehicle or plug-in hybrid, you'll love our e-Remote Control app feature. Use it to pre-condition your cabin temperature before journeys – and maximise your charge. Or pre-schedule charging times at night, and benefit from cheaper electricity.



Phone_MyVauxhall_mockup_Car.psd

*Standard on all Astra models. Subject to subscription – after you have taken delivery of your vehicle, please subscribe on: connect.vauxhall.co.uk
**via MyVauxhall App. †Additional terms and conditions apply to connected services, including customer acceptance of location sharing prior to activation.

For more information visit vauxhall.co.uk/discover/myvauxhall.html

Comfort and convenience

Model specific features/option	Design	Design Electric	GS	GS Plug-in Hybrid/Electric	Ultimate	Ultimate Plug-in Hybrid/Electric	GSe Plug-in Hybrid
Interior convenience							
Reach and rake adjustable steering	●	●	●	●	●	●	●
Steering wheel audio/phone/cruise controls	●	●	●	●	●	●	●
60/40 split-folding rear seat backs (Hatchback only)	●	●	●	●	●	●	●
Twin electrically adjustable/heated door mirrors	●	●	●	●	●	●	●
Electrically operated front and rear windows with safety autoreverse and one-touch up/down facility	●	●	●	●	●	●	●
Paddle shift (excludes Electric)			auto only	●	auto only	●	●
Front centre armrest with cup holder			●	●	●	●	●
Centre rear seat armrest and load-through facility			●	●	●	●	●
Frameless automatic anti-dazzle rear-view mirror			●	●	●	●	●
Flex load floor			●		●		
Wireless charger for mobile devices					●	●	●
Keyless start	●	●					
Keyless entry and start			●	●	●	●	●
Heating and ventilation							
Electronic climate control	●	●					
Dual-zone electronic climate control			●	●	●	●	●
Heated steering wheel and front seats			●	●	●	●	●
Heated windscreen					●	●	●
Interior seating							
Nappa Leather seat trim inserts with driver's seat memory, massage and ventilation functions (excludes Electric and 1.2 (136PS) Turbo Hybrid e-DCT6 auto)					£2100*	£2100*	£2100*

*Optional at extra cost including VAT.

Comfort and convenience

Model specific features/options	Design	Design Electric	GS	GS Plug-in Hybrid/Electric	Ultimate	Ultimate Plug-in Hybrid/Electric	GSe Plug-in Hybrid
Interior lighting							
Illuminated vanity mirrors and rear reading lights	●	●	●	●	●	●	●
Ambient lighting – customisable with eight different colours			●	●	●	●	●
Interior styling							
Black headliner			●	●	●	●	●
Alloy-effect sports pedals			●	●	●	●	●
Exterior convenience							
Manually folding door mirrors	●	●					
Power folding door mirrors with puddle light			●	●	●	●	●
Electrically operated slide/tilt glass sunroof with blind					●	●**	●
Tow bar	£605*	£605*	£605*	£605*	£605*	£605*	£605*
Provision for spare wheel fitment – spare wheel is Retailer-fit, deletes emergency tyre inflation kit (Hatchback only)	£20*		£20*				
Power tailgate (Sports Tourer only)					●	●	●
7.4kW on-board charger – halves charging time when charging with a 7kW wallbox (Plug-in Hybrid only)				£500*		£500*	£500*

*Optional at extra cost including VAT. **Please note, a delete sunroof option is available at no-cost on Electric models only, please consult your Retailer.



Ambient lighting.



Alloy-effect sports pedals.



Electrically operated slide/tilt glass sunroof with blind.

Versatility – Sports Tourer

The following features are available across the Astra Sports Tourer range. Specific features by model are outlined in the separate tabular information.

Intelli-Space

- 40/20/40 split-folding rear seat backs
- Easy accessible storage boxes in the boot floor accommodate tyre inflation kit and first-aid kit
- Side storage with nets
- Luggage compartment retractable cover

Additional features (petrol)

- Spare-wheel storage area
- Rear seat backs with remote easy-fold facility

Additional feature (Plug-in Hybrid/Electric)

- Special under-carpet storage space for battery, charging cable, tyre inflation kit and first-aid kit

Model specific features/options	Design	GS	GS Plug-in Hybrid	Ultimate	Ultimate Plug-in Hybrid	GSe Plug-in Hybrid
Interior load area						
Fixed floor			●	●	●	●
Flex load	●	●				
Rear seat load-through facility with armrest and cup holders		●	●	●	●	●
Intelli-Space load floor adjustable in two heights for flat load area. Adds additional 40 litres of load volume in lower position	●	●				
High gloss black roof rails				●	●	●
Luggage restraining nets (Sports Tourer only)	£200*	£200*	£200*	£200*	£200*	£200*

*Optional at extra cost including VAT.



Intelli-Space 40/20/40 split rear seats.



Intelli-Space adjustable load floor.



Easy accessible storage boxes.

Safety and security

Model specific features	Design	Design Electric	GS	GS Plug-in Hybrid/Electric	Ultimate	Ultimate Plug-in Hybrid/Electric	GSe Plug-in Hybrid
Airbags							
Driver's and front passenger's airbag	●	●	●	●	●	●	●
Front seat side-impact and full-size curtain airbags	●	●	●	●	●	●	●
Braking and stability							
In crash braking – the system automatically brakes the vehicle to help it come to a standstill after a severe collision	●	●	●	●	●	●	●
Hill start assist – holds the vehicle steady for two seconds on slopes with a gradient of over 3% after the brake pedal is released	●	●	●	●	●	●	●
Anti-lock Braking System (ABS) and Electronic Stability Programme (ESP)	●	●	●	●	●	●	●
Rollover mitigation – constantly monitors the vehicle behaviour, with the help of the ESP, to intervene when the vehicle threatens to roll over	●	●	●	●	●	●	●
Drag torque control – maintains stability on slippery roads when lifting off the accelerator or changing gear	●	●	●	●	●	●	●
Emergency brake assist with fading brake support	●	●	●	●	●	●	●
Electronic brakeforce distribution	●	●	●	●	●	●	●
Adaptive brake lights	●	●	●	●	●	●	●
Child safety							
Deactivation switch for front passenger's front and side-impact bags	●	●	●	●	●	●	●
ISOFIX child seat mountings – located on outer rear seats incorporating top tether mounting points. (Does not include child seat)	●	●	●	●	●	●	●
Security							
Remote control ultrasonic security alarm system	●	●	●	●	●	●	●
Locking wheel bolts for alloy wheels	●	●	●	●	●	●	●

Styling

Model specific features/options	Design	Design Electric	GS	GS Plug-in Hybrid/Electric	Ultimate	Ultimate Plug-in Hybrid/Electric	GSe Plug-in Hybrid
Exterior styling							
Body-colour door handles	●	●	●	●	●	●	●
Black lower window moulding	●	●	●	●	●	●	●
Black-painted door mirrors	●	●	●	●	●	●	●
Body-colour bumpers with grained black lower front grille and rear valance panel	●	●					
Body-colour sports-style bumpers with high gloss black lower front grille, decor blade and rear valance panel		●	●	●	●	●	
Unique GSe body-colour sports-style bumpers with high gloss black lower front grille, decor blade and rear valance panel							●
Chrome-effect Griffin logo and Black vizer frame	●	●					
Black Griffin logo and vizer frame			●	●	●	●	●
Dark-tinted rear windows			●	●	●	●	●
Body-colour roof and rear spoiler	●	●	No-cost	No-cost	No-cost	No-cost	No-cost
Carbon black roof and rear spoiler**			●	●	●	●	●
18-inch bi-colour diamond-cut alloy wheels with red inserts†			£300*				

*Optional at extra cost including VAT. **Standard with Carbon Black body colour. †Not available with Electric Yellow or Cobalt Blue paints.



Black Griffin logo and vizer frame.



Black roof and dark-tinted rear windows.



Rear styling.

Exterior colours

Arctic White (POWP)*
Brilliant paint



VX_AST_PHEV_32844.psd

Carbon Black (M49V)**
Two-coat metallic paint £600



VX_AST_PHEV_32850.psd

Vulcan Grey (MOVL)**
Two-coat metallic paint £600



VX_AST_PHEV_32848.psd

Crystal Silver (MOZR)**
Two-coat metallic paint £600



VX_AST_PHEV_32849.psd

Crimson Red (M5PQ)**
Two-coat premium metallic paint £700



VX_AST_PHEV_32845.psd

Electric Yellow (MORV)†
Two-coat premium metallic paint £700



VX_AST_PHEV_32847.psd

Cobalt Blue (M6SM)††
Tri-coat premium metallic paint £700



VX_AST_PHEV_32846.psd

The colours reproduced may vary slightly from the actual paint colour. As a result they should be used as a guide only. Your Vauxhall Retailer has a comprehensive display of our paint samples. Please note, vehicles illustrated are not model specific and are for illustrative purposes only.

*Standard exterior paint. **Optional at extra cost including VAT. †Optional at extra cost including VAT. Not available on GSe or Sports Tourer models. ††Optional at extra cost including VAT. Not available on GSe models.

PureEnergy – Electric

Single-speed electronic drive selector

As the motor is an all-electric single-speed drive unit, there is no need for multiple gears. Instead, the shifter lets the driver select from the following:

- Park • Reverse • Neutral • Drive
- Braking (for increased regenerative braking)

Drive mode selector

The driver can determine the driving style by selecting one of the following modes:

- **Normal:** for a balanced drive that offers a compromise between performance and energy efficiency
- **Sport:** for a dynamic drive with a responsive throttle and the highest top speed and torque
- **ECO:** for maximum range and energy efficiency. The ECO mode deactivates all unnecessary energy-consuming features and reduces the top speed, torque and overall performance

Charging

Astra Electric is fitted with a 11kW on board charger and is also equipped with a Mode 3 cable as standard. Additional charging accessories are available at extra cost. For more details please consult your local Retailer.

The charging flap's Padlock LED lights up when the cable is correctly plugged in and locked and then acts as a user interface to show the charging status via coloured LED lights:

- **White:** welcome light that helps to light up the area, especially useful in dark conditions
- **Flashing green:** charging in progress
- **Solid green:** charging complete
- **Solid blue:** delayed charging toggled; changes to flashing green when charging commences
- **Solid red:** malfunction

The driver may also choose from two settings:

- **Immediate charging (the standard setting):** Starts charging as soon as the vehicle is docked for charging
- **Delayed charging:** This is especially useful for when cheaper electric rates are desired, e.g. charging at night. Simply enter a charging start time

Please note, EV range assumes that vehicle has been pre-conditioned prior to journey. This function can be accessed either via MyVauxhall App or by using the infotainment system.

Drivetrain – Electric		
CO ₂ emissions	0g/km	
Maximum power (Sport mode)	115kW (156PS)	
Maximum torque (Sport mode)	270Nm (199lb.ft.)	
Acceleration 0 – 62mph	9.2 secs	
Maximum speed	105mph	
Transmission	All-electric single-speed drive unit	
Service interval	Initial inspection at 8,000 miles/1 year (whichever comes sooner). Thereafter 16,000 miles/2 years (whichever comes sooner)	
Battery		
Battery capacity	54kWh	
AC on-board charger speed	11kW	
EAER (WLTP high)*	252 – 260 miles	
Energy consumption (WLTP)*	14.8 – 15.2kWh/100km	
Battery warranty	8 years/100,000 miles/70% capacity	
Charging (Supply)	Socket	Charge Time (0 – 100%)
AC current – Domestic 3 pin socket (2.3kW)	Type 2	26h 25m
AC current – Home wallbox or public charger (7kW)	Type 2	8h
AC current – Public charger (11kW)	Type 2	5h 45m
DC current – Rapid charger (100kW)	CCS	26m (20 – 80%)
Charging cables	11kW on-board charger	
Mode 3, 3-phase 22kW cable	Standard	

The Astra Electric is a battery electric vehicle requiring mains electricity for charging. Range data given has been determined according to WLTP test procedure methodology. The figures shown are intended for comparability purposes only and should only be compared to other cars tested to the same technical standard. The range you achieve under real world driving conditions will depend upon a number of factors, including but not limited to: the accessories fitted (pre and post registration); charging frequency; personal driving style; vehicle load and route characteristics; variations in weather; heating/air conditioning; pre-conditioning and battery condition. For more information, contact your local Vauxhall Retailer.

EAER = Equivalent All Electric Range. *WLTP preliminary.

PureEnergy – Plug-in Hybrid

Electrified transmission

The 8-speed electrified transmission system is standard and offers both smooth transition between gears. The 8-speed electrified gearbox includes the following content:

- Multi-disc wet clutch replaces removed torque converter
- Permanent electric motor that transforms electric energy into mechanical drive energy
- Electric motor installed into the gearbox and petrol engine
- Comes with intuitive and stylish automatic gearbox with electric shifter with shift paddles

The current driving position is indicated to the driver with a LED between:

- **R:** used for reverse driving
- **N:** used for neutral, allowing the vehicle to be moved with ignition off
- **D:** used for automatic drive, the gearbox change gears without any action from the driver
- **B button:** to switch to regenerative braking

Drive mode selector

The driver can determine the driving style by selecting one of the following modes:

- **Normal:** is the default Hybrid mode and offers the best of both worlds between controlled fuel consumption and on-road performance

- **Sport:** draws on the combined power of the engine and motor for a more dynamic drive
- **Electric:** activates the electric motor only, for zero CO₂ emissions and complete silence
- **Engine sound enhancement:** In the Sport mode, the engine sound is amplified via the radio speakers depending on input factors such as vehicle speed, engine speed, acceleration, gear and pedal position

Charging

- Astra Plug-in Hybrid range comes with a Mode 2 cable and a 3.7kW on-board charger as standard. Includes cable bag at no extra cost

Please note: A Mode 2 cable (standard UK socket*) would charge the vehicle in less than 8 hours.

Astra Plug-in Hybrid range charging time examples are listed showing times dependant on the various powers of charge point which the vehicle is plugged into.

Please note, EV range assumes that vehicle has been pre-conditioned prior to journey. This function can be accessed either via MyVauxhall App or infotainment system.

Preliminary data determined according to WLTP test procedure methodology. EU type approval and Certificate of Conformity are not yet available. Preliminary values may differ from official final type approval data. Charging rate depends on power source and charging cable used.

These figures were obtained using a combination of battery power and fuel. The Astra Plug-in Hybrid requires mains electricity for charging.

*WLTP Figures shown are for comparison purposes and should only be compared to the fuel consumption, CO₂ values and electric range of other cars tested to the same technical standard. The fuel consumption and electric range achieved, and CO₂ produced, in real world conditions will depend upon a number of factors including, but not limited to: the accessories fitted (pre and post registration); charging frequency; battery condition; variations in weather; driving styles and vehicle load. For more information contact your local Vauxhall Retailer.

EAER = Equivalent All Electric Range. *Only use a domestic electrical socket that has been checked by a qualified electrician and is protected by a circuit breaker adapted to the amperage of the electrical circuit. **Requires optional 7kW on board charger.

Petrol engine	1.6 (180PS)	1.6 (225PS)
Maximum power	150PS (110kW) @ 6000rpm	180PS (133kW) @ 6000rpm
Combined power	180PS (133kW) @ 6000rpm	225PS (165kW) @ 6000rpm
Maximum torque	250Nm (184lb.ft.) @ 1750rpm	250Nm (184lb.ft.) @ 1750rpm
Combined torque	360Nm (265lb.ft.) @ 6000rpm	360Nm (265lb.ft.) @ 6000rpm
Combined CO ₂ emissions (WLTP)#	28 – 30g/km	30g/km
Combined fuel economy (WLTP)#	217 – 235 mpg (1.2 – 1.3 l/100km)	217 mpg (1.3 l/100km)
Combined maximum speed	140mph	146mph
0 – 62mph	7.7 secs	7.5 secs
Configuration	4 cylinders, 4 valves per cylinder, double overhead camshafts	
Fuel/induction system	Turbocharger. Variable Valve Timing. Common rail direct injection	
Emission compliance	Euro 6.4	
Service interval	20,000 miles or 1 year (whichever occurs sooner)	
Electric motor	1.6 (180PS)	1.6 (225PS)
Maximum power	110hp (81kW) @ 2500rpm	110hp (81kW) @ 2500rpm
Battery	1.6 (180PS)	1.6 (225PS)
Battery capacity	12.4kWh	12.4kWh
AC on-board charger speed (standard)	3.7kW	3.7kW
EAER (WLTP high)#	up to 35 miles	up to 35 miles
Energy consumption (WLTP combined)	15.9 – 16.5kWh/100km	17.7 – 17.8kWh/100km
Battery warranty	8 years/100,000 miles/70% capacity	
Charging (Supply AC current)	Socket	Charge Time (0 – 100%)
Domestic 3 pin socket (2.3kW)	Type 2	5h 30m
Home wallbox or public charger (3.6kW)	Type 2	3h 30m
Home wallbox or public charger (7kW)**	Type 2	1h 55m

PureEnergy – Petrol

Petrol engines	1.2 (110PS) Turbo	1.2 (130PS) Turbo	1.2 (136PS) Turbo Hybrid e-DCT6 auto
Capacity	1199cc	1199cc	1199cc
Maximum power	110PS (81kW) @ 5500rpm	130PS (96kW) @ 5500rpm	136PS (100kW) @ 5500rpm
Maximum torque	205Nm (151lb.ft.) @ 1750rpm	230Nm (169lb.ft.) @ 1750rpm	230Nm (169lb.ft.) @ 1750rpm
Configuration	3 cylinders, 4 valves per cylinder, double overhead camshafts	3 cylinders, 4 valves per cylinder, double overhead camshafts	3 cylinders, 4 valves per cylinder, double overhead camshafts
Fuel/induction system	Turbocharger. Variable Valve Timing (VVT). Spark ignited direct injection (SIDI)	Turbocharger. Variable Valve Timing (VVT). Spark ignited direct injection (SIDI)	Turbocharger. Variable Valve Timing (VVT), Spark ignited direct injection (SIDI)
Emission compliance	Euro 6.4	Euro 6.4	Euro 6.4
Service interval	12,500 miles or 1 year (whichever occurs sooner)	12,500 miles or 1 year (whichever occurs sooner)	16,000 miles or 1 year (whichever occurs sooner)

*Figures shown are for comparison purposes and should only be compared to the fuel consumption and CO₂ values of other cars tested to the same technical standard. The fuel consumption achieved, and CO₂ produced, in real world conditions will depend upon a number of factors including, but not limited to: the accessories fitted (pre and post registration); variations in weather; driving styles and vehicle load. The WLTP (Worldwide Harmonised Light Vehicles Test Procedure) is used to measure fuel consumption and CO₂ figures. The CO₂ figures display a range to reflect the highest value for the highest emitting version with all available options added, through to a minimum value to represent the lowest emitting version in standard specification.

*Correct at time of publication.

PureEnergy – Petrol

Performance, fuel economy and emissions	Performance (manufacturer's figures)		Fuel economy mpg (litres/100km)*		CO ₂ emissions g/km#		Vehicle Excise Duty*		BiK rates from – 2023/24 tax year
	Maximum speed (mph)	Acceleration 0 – 62mph (sec)	Combined Low	Combined High	Combined Low	Combined High	First year rate	Standard rate	
Hatchback									
1.2 (110PS) Turbo	124	10.5	52.3 (5.4)	52.3 (5.4)	123	123	£220	£190	29%
1.2 (130PS) Turbo	130	9.7	49.6 (5.7)	52.3 (5.4)	123	128	£220	£190	29%
1.2 (130PS) Turbo auto	130	9.7	48.7 (5.8)	50.4 (5.6)	125	131	£270	£190	31%
1.2 (136PS) Turbo Hybrid e-DCT6 auto	130	9.0	56.5 (5.0)	60.1 (4.7)	106	112	£185	£190	26%
Sports Tourer									
1.2 (110PS) Turbo	124	10.8	51.4 (5.5)	51.4 (5.5)	125	125	£220	£190	30%
1.2 (130PS) Turbo	130	10.0	48.7 (5.8)	50.4 (5.6)	126	131	£220	£190	30%
1.2 (130PS) Turbo auto	130	9.9	47.9 (5.9)	49.6 (5.7)	128	134	£270	£190	30%
1.2 (136PS) Turbo Hybrid e-DCT6 auto	130	9.3	55.4 (5.1)	58.9 (4.8)	108	114	£185	£190	26%

*Figures shown are for comparison purposes and should only be compared to the fuel consumption and CO₂ values of other cars tested to the same technical standard. The fuel consumption achieved, and CO₂ produced, in real world conditions will depend upon a number of factors including, but not limited to: the accessories fitted (pre and post registration); variations in weather; driving styles and vehicle load. The WLTP (Worldwide Harmonised Light Vehicles Test Procedure) is used to measure fuel consumption and CO₂ figures. The CO₂ figures display a range to reflect the highest value for the highest emitting version with all available options added, through to a minimum value to represent the lowest emitting version in standard specification.

*Correct at time of publication.

Specifications

Transmissions

Six-speed manual gearbox

Petrol engines: 1.2 (110/130PS) Turbo

Eight-speed automatic transmission

Petrol engine: 1.2 (130PS) Turbo

This transmission enables increased drive comfort with improved fuel economy and features a manual shifting mode. For a more engaging drive, the driver can select gears using the shift paddles located on the steering wheel.

Drive mode selector (auto-only)

The driver can determine the driving style by selecting one of the following modes:

- **Normal:** for a balanced drive that offers a compromise between performance and energy efficiency
- **Sport:** for a dynamic drive with a responsive throttle and the highest top speed and torque
- **ECO:** for maximum range and energy efficiency. The ECO mode deactivates all unnecessary energy-consuming features and reduces the top speed, torque and overall performance

Steering

- Power-assisted steering
- Turning circle (wall-to-wall):
 - 10.51m (34.5ft.) Hatchback
 - 10.71m (35.1ft.) Sports Tourer

Fuel tank capacities

- 52 litres – Petrol
- 42 litres – Plug-in Hybrid

Suspension

- Front: Independent. Decoupled MacPherson struts with gas-pressure dampers and coil springs. Anti-roll bar
- Rear: Compound crank with coil springs and gas-pressure dampers

GSe

Re-calibrated sports steering

Revised steering geometry provides increased feedback and allows the driver to more accurately judge grip levels.

Unique chassis set-up

Bespoke chassis set-up delivering a more agile and precise handling experience without sacrificing ride quality.

- Ride height lowered by 10mm
- Front suspension: Independent decoupled MacPherson struts with Koni FSD (Frequency Selective Damping) oil-filled dampers and revised springs. Anti-roll bar
- Rear suspension: Compound crank with coil springs and Koni FSD oil-filled dampers and revised springs

Unique ESP settings

Adjustments have also been made to the electronic stability program which monitors the traction control. This enables the system to respond more effectively to cope with the increase in engine power and greater dynamic driving behaviour made possible by the chassis improvements.

Please note: Gross vehicle weight is the total permissible weight of the vehicle including passengers and their luggage. The maximum roof rack loading should not exceed 75kg. The maximum towing weights are based on the ability of the car, with two occupants of 75kg each, to restart on a 12% gradient, which is approximately 1 in 8.3, at sea level. The permitted trailer load applies up to the specified incline and up to an altitude of 1000 metres above sea level. The permissible gross train weight decreases by 10% for every 1000 metres of additional altitude. At altitudes above 1500 metres, the engine output may drop with a corresponding reduction in towing capability. Any extra weight, such as luggage or additional passengers, should be deducted from the maximum towing weight. With a trailer fully loaded, maximum noseweight should not exceed 75kg. Always fit Vauxhall towing attachments and accessories available from your Vauxhall Retailer. They are designed specifically for Vauxhall models and carry a 12-month guarantee.

*Measured using the ECIE method. When a spare wheel is specified loadspace capacity is reduced due to a raised luggage compartment floor. **Plug-in Hybrid and Electric. †Factory-fit. ††Retailer-fit.

Exterior dimensions – mm (inches)	Hatchback	Sports Tourer		
Length	4374 (172.2)	4642 (182.8)		
Width (with mirrors)	2062 (81.2)	2062 (81.2)		
Height	1441 (56.7)	1443 (56.8)		
Wheelbase	2675 (105.3)	2732 (107.6)		
Loadspace dimensions – mm (inches)	Hatchback	Sports Tourer		
Load floor length (rear seats folded)	1589 (62.5)	1850 (72.8)		
Load floor length (behind rear seats)	795 (31.3) 770 (30.3)**	1026 (40.3) 1018 (40.0)**		
Load area width	1020 (40.2)	1032 (40.6)		
Load area height	599 (23.5) 601 (23.6)**	599 (23.5) 601 (23.6)**		
Tailgate aperture height	526 (20.7)	482 (18.9)		
Luggage capacities* – Litres (cu.ft.)	Hatchback	Sports Tourer		
Rear seat up (under luggage compartment cover)	422 (14.9) 352 (12.4)**	597 (21.0) 516 (18.2)**		
Rear seat down (measured to roof)	1339 (47.2) 1268 (44.7)**	1634 (57.7) 1553 (54.8)**		
Weights and towing data – kg	Gross vehicle weight		Max. towing weights. Trailer with brakes (without brakes)	
	Hatchback	Sports Tourer	Hatchback	Sports Tourer
1.2 (110PS) Turbo	1820	1870	1250 (660)	1200 (680)
1.2 (130PS) Turbo	1840	1880	1250 (660)	1200 (690)
1.2 (130PS) Turbo auto	1880	1900	1400 (680) [†] / 1200 (680) ^{††}	1400 (680) [†] / 1200 (680) ^{††}
1.2 (136PS) Turbo Hybrid e-DCT6 auto	1950	1990	1150 (600)	1100 (600)
1.6 (180PS) Turbo/Electric auto	2150	2170	1450 (750)	1400 (750)
1.6 (225PS) Turbo/Electric auto	2150	2170	1450 (750)	1400 (750)
Electric Propulsion (156PS) auto	2100	2170	–	–

Company car driver and fleet information

Benefit in kind company car taxation*

The car benefit charge will be the car's list price (including VAT, options and accessories fitted, delivery to Retailer and number plates, but excluding Vehicle Excise Duty and new vehicle first registration fee) multiplied by the percentage charge for the CO₂ emissions band in which the car falls (see table opposite). Multiply this figure by your personal income tax rate (20%** for Basic Rate, 40%** for Higher Rate) to calculate your annual benefit in kind tax liability.

Generic example:

ELECTRIC vehicle: 0g/km CO₂

On-the-road RRP	£27,305.00
Deduct: Vehicle Excise Duty	£0.00
New vehicle first registration fee	-£55.00
Effective list price	£27,250.00
Add: Optional two-coat metallic paint	£600.00
List price for tax purposes (P11D value)	£27,850.00
Car benefit charge 2023 – 24 tax year (2%)	£557.00
Benefit in kind tax liability	
Basic Rate (20%) tax payer	£111.40
Higher Rate (40%) tax payer	£222.80

*Please note this Price Guide provides taxation information as a guide only. Vauxhall does not provide taxation guidance. Drivers should always take professional advice on their own tax position.
**Excludes residents of Scotland.

BiK for Scottish Residents

Effective 6 April 2018 the Scottish Government have introduced their own BiK taxation structure. This only applies to Company Car Drivers that are Scottish taxpayers. HMRC will determine whether or not an individual is a Scottish taxpayer based on where their main place of residence is.

The BiK rates for Scotland are:

- Over £12,570 – £14,732 Starter Rate 19%
- Over £14,732 – £25,688 Basic Rate 20%
- Over £25,688 – £43,662 Intermediate Rate 21%
- Over £43,662 – £150,000 Higher Rate 41%
- Above £150,000 Top Rate 46%

To calculate your own personal liability, click the link [Vauxhall BiK Tool](#)

CO ₂ (g/km)	Electric range (miles)	% 2024 – 25 tax year
0	-	2%
1 – 50	130+	2%
1 – 50	70 – 129	5%
1 – 50	40 – 69	8%
1 – 50	30 – 39	12%
1 – 50	<30	14%
51 – 54	-	15%
55 – 59	-	16%
60 – 64	-	17%
65 – 69	-	18%
70 – 74	-	19%
75 – 79	-	20%
80 – 84	-	21%
85 – 89	-	22%
90 – 94	-	23%
95 – 99	-	24%
100 – 104	-	25%
105 – 109	-	26%
110 – 114	-	27%
115 – 119	-	28%
120 – 124	-	29%
125 – 129	-	30%
130 – 134	-	31%
135 – 139	-	32%
140 – 144	-	33%
145 – 149	-	34%
150 – 154	-	35%
155 – 159	-	36%
160+	-	37%

Vehicle Excise Duty†

The amount of Vehicle Excise Duty (road fund licence) payable on new cars varies depending on the level of carbon dioxide (CO₂) emissions produced by the vehicle. CO₂ emissions are measured in grams per kilometre (g/km) travelled and divided into 13 charging bands shown in the table below.

A 'first year rate' of Vehicle Excise Duty is payable on all new cars and in subsequent years the amount payable reverts to a different rate. Also, for vehicles with a list price over £40,000, including factory-fitted options, an additional £390 is payable for five years after registration.

VED Band	CO ₂ (g/km)	First year rate Petrol/ Diesel	First year rate Hybrid/ Electric
A	0	£0	£0
B	1 – 50	£10	£0
C	51 – 75	£30	£20
D	76 – 90	£135	£125
E	91 – 100	£175	£165
F	101 – 110	£195	£185
G	111 – 130	£220	£210
H	131 – 150	£270	£260
I	151 – 170	£680	£670
J	171 – 190	£1,095	£1,085
K	191 – 225	£1,650	£1,640
L	226 – 255	£2,340	£2,330
M	Over 255	£2,745	£2,735

†Correct at time of issue.

Fleet Toolbox

The Fleet Toolbox has a host of useful calculators, comparators, interactive listings and information.

Click the link for more information

[Vauxhall Fleet Tool Box](#)

Contact Vauxhall Fleet

Please contact one of our dedicated sales teams who will be happy to help with your particular enquiry.

Fleet Decision Makers

Depending on the size of your fleet of vehicles, we have a dedicated team to handle your enquiries. The lines are open Monday to Friday excluding Bank Holidays.

1 – 24 vehicles

Call: 0203 885 4560 (8:30am – 5:00pm)

Email: enquiries@stellantis-fleet.co.uk

50+ vehicles

Call: 0203 885 4562 (8:30am – 5:00pm)

Email: enquiries@vauxhallfleet.co.uk

Special Vehicles (Police, Fire and Ambulance)

Call: 01582 409999

Email: psvo@stellantis.com

For more information visit vauxhall.co.uk/fleet

Further information

On-the-road prices

To eliminate uncertainty about hidden costs when buying a new car, Vauxhall publishes on-the-road recommended retail prices (RRP) and these are shown in the pricing tables within this price guide. These prices include VAT, number plates and delivery to Retailer of £900.00 (including £150.00 VAT), 12 months' Government Vehicle Excise Duty and the DVLA new vehicle first registration fee of £55.00.*

Please note: The on-the-road recommended retail price (RRP) does not include fuel supplied by the Retailer, motor insurance or any other goods or services supplied by agreement between the Retailer and the customer.

Price protection

Order a new Vauxhall for build in the current model year (as confirmed by your Retailer) for delivery no more than three months in advance and the price you are quoted is the price you pay. This is irrespective of any subsequent price rises between placing your order and delivery of your new car, but you must take delivery as soon as the car is available. Please note: Vauxhall Motors Limited is not liable for price adjustments caused by Government changes in the rate of VAT (currently 20%), Vehicle Excise Duty, DVLA new vehicle first registration fee or by any other applicable legislation or regulations.

Customer Care Commitment

For added peace of mind, Vauxhall has an innovative Customer Care Commitment that offers the following:

- Three-year vehicle warranty consisting of a one year/unlimited mileage manufacturer's warranty and a second and third year manufacturer's warranty with a 60,000 miles limitation

- Vauxhall Assistance for 12 months from first registration
- Six years' body panel anti-perforation warranty

Please note: Warranty is only available on vehicles sourced from Vauxhall Motors Limited. Terms and conditions apply – please see your Vauxhall Retailer for details.

Vauxhall Assistance

Vauxhall Assistance is provided automatically with every new Vauxhall for 12 months from first registration and covers everything from accident assistance, roadside recovery and 'at home' service to flat tyres. For even more peace of mind, on fully electric models, the cover is extended** to 3 years. Even more reason for you to stay calm and let us take care of everything should the need arise. With Vauxhall Assistance help is literally just a free† phone call away, 24 hours a day, 365 days a year!

LEASYS

Leasys UK

Leasys is the proud Business Contract Hire partner of Vauxhall and consequently, can provide quick vehicle delivery to keep your business mobile. Specialised in Medium to Long-Term Leasing options and Fleet Management solutions for businesses of all sizes, [Leasys](#) lead mobility by offering sustainable and innovative solutions designed around customers, for a best-in-class experience. Their team of experts can personally support you and provide dedicated consultation. [Leasys](#) is equally owned by Stellantis and Crédit Agricole Consumer Finance and is a member of the British Vehicle Rental and Leasing Association (BVRLA). For further information, please contact your local Vauxhall Retailer or visit [leasys.com/uk](#)

In the event of an accident

Vauxhall Accident Management helps keep you mobile following an accident. Benefits include vehicle recovery, Vauxhall-approved repairs and contacting your insurer. For more details, visit [vauxhall.co.uk/AccidentManagement](#)

Vauxhall Flexcare – Service Plans and Extended Warranty

Designed for your peace of mind. A collection of extended warranty and service plans to match the way you drive.

Extended Warranty

An extended warranty for your Vauxhall offers you similar cover for material or manufacturing defects beyond the original warranty period on the vehicle. By choosing an official Vauxhall Extended Warranty, we guarantee that any repairs you need are carried out by Vauxhall trained technicians using genuine Vauxhall parts.

Service Plans

There's no need to worry about budgeting for your next service. Simply take out a Vauxhall Fixed Price Service Care Plan. You can then focus on the more important things in life, knowing your servicing costs are taken care of. For more information, click on the link below or call us on **0345 600 2065**. See [vauxhall.co.uk/discover/here-for-you.html](#)

Vauxhall Service Club

A world of servicing, repair and accessory benefits with Vauxhall Service Club is available for all Vauxhall owners, and it's free to join via the MyVauxhall app (terms and conditions apply). For a list of benefits and details on how to join visit: [vauxhall.co.uk/serviceclub](#)

Vauxhall Insurance with added reassurance

Join the family or find out more about Vauxhall Insurance Services by contacting our insurance team on **0330 678 1130**††, or visit: [vauxhall.co.uk/offers-finance/insurance.html](#)

Vauxhall Accessories

From the small things that make life easier to the big things that make life exciting – personalise your Vauxhall with Vauxhall Accessories. So what are you looking for? A device holder, roof box, or even splash guards? Whatever it is we've got the solution for you. With our huge accessory range, all tailor-made for your Vauxhall and come with a full year's warranty. For further details visit your local Retailer or see [vauxhall.co.uk/owners/accessories.html](#)

Protecting the environment

Vauxhall's commitment to the environment is demonstrated by our products' many environmental awards. For even more information on Vauxhall's efforts to achieve an environmentally sustainable future, and how to dispose of your end-of-life vehicle, see [vauxhall.co.uk/recycling](#)

For more product information

For further information on the Vauxhall range or location of your nearest Vauxhall Retailer please call **0800 026 0034**. Alternatively, details can be found on our website at [vauxhall.co.uk](#)

VAUXHALL

For more information call **0800 026 0034**

For Fleet enquiries call **0203 476 2268**

Discover the full Vauxhall range at **[vauxhall.co.uk](https://www.vauxhall.co.uk)**

Join us online

The invoice price, including delivery to Retailer, factory-fitted options, accessories fitted by the Retailer and number plates, is subject to VAT. Some feature descriptions in this guide may refer to, and some illustrations may show, optional equipment not included in the standard delivery. The information contained in this guide was accurate at the time of publication. We reserve the right to make changes in design and equipment. Please note that Vauxhall Retailers are not the agents of Vauxhall Motors Limited and are not authorised to bind Vauxhall Motors Limited by any specific or implied undertaking or representation. It is advisable to ensure that your motor insurance policy provides adequate cover for additional fitted options and accessories. The colours in this guide are only approximate actual colours. Illustrated optional equipment is available at extra charge. Availability, technical features and equipment provided on our vehicles can vary by model. For precise information on the equipment provided on our vehicles, please contact your local Vauxhall Retailer.

Price and Specification Guide
5 June 2024 | Model Year 2024C



New Mokka

Contents

To find the information you want use the links below to navigate around the guide:

Models

Prices

Vauxhall PureSense

Vauxhall PureConnect

Comfort and convenience

Safety and security

Styling

Exterior colours

Vauxhall PureEnergy

Specifications

Company car information

Further information

At Vauxhall, we believe great cars are for everyone.

We believe technology works best when it's not just smart but is also simple and intuitive. Where everyone can feel the instant excitement of electric; can keep themselves and their loved ones safer on the road; and can stay connected to the things that matter most, simply and easily. We call it Vauxhall Pure Technology. No gimmicks, nothing complicated, just technology that makes driving better, easier and more exciting, for everyone.

Our latest Mokka Price and Spec guide outlines the Pure Technology features model by model. Together with all the essential information you need to compare Prices, Technical Information and Specification plus details of our commitment to offer the best in Customer Care.

We're delighted you're considering the purchase of a new Mokka and hope this guide will help you make the right choice.



Griffin

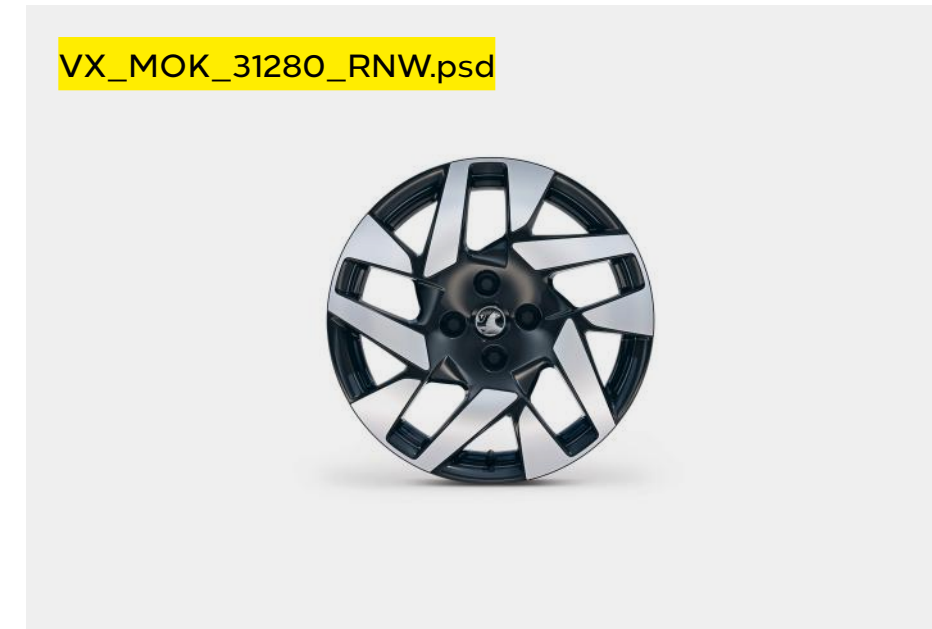

17-inch alloy wheel.



Standard features include:

PureSense

- Rear parking distance sensors
- Panoramic rear-view camera
- LED headlights and tail lights
- LED daytime running lights
- High beam assist
- Lane departure warning with lane keep assist
- Extended traffic sign recognition
- Driver drowsiness alert
- Enhanced automatic emergency braking with pedestrian detection
- Forward collision alert (low speed)
- Cruise control with intelligent speed limiter
- Six airbags
- Hill start assist
- Remote control central locking
- Automatic lighting control with tunnel detection

PureConnect

- Multimedia Pure Panel system
 - 7-inch colour touchscreen
 - 7-inch digital instrument cluster
 - AM/FM/DAB digital radio
 - Bluetooth®
 - Front USB connection
- Six speakers
- Vauxhall Connect (Electric only)

Comfort and convenience

- Air conditioning
- Heated flat bottomed leather-effect steering wheel
- Electrically adjustable/heated door mirrors
- Steering wheel audio/phone/cruise controls
- Rain-sensitive windscreen wipers (auto models only)
- Automatic anti-dazzle rear-view mirror (auto models only)
- Keyless start (Electric only)
- Front centre armrest with storage
- Moveable boot floor

Interior

- Heated front seats
- Driver's seat (six-way adjustable)
- Front passenger's seat (four-way adjustable)
- Jet black fabric seat trim inserts
- Light grey fabric side bolsters
- Black facia with silver trim inserts
- Light grey trim inserts on front doors
- Grey headliner

Styling

- 17-inch silver alloy wheels with 215/60 R 17 tyres
- Body coloured front/rear bumper inserts
- Black painted rear spoiler
- Chrome-effect upper window moulding
- Dark-tinted rear windows
- Black roof
- Available in any exterior colour

GS



18-inch alloy wheel.

18-inch alloy wheel
(No-cost option).*

Features over and above Griffin:

PureSense

- Remote control ultrasonic security alarm system
- Sports switch with engine sound enhancement

PureConnect

- Multimedia Pure Panel Navigation system
 - 10-inch colour touchscreen
 - 12-inch digital instrument cluster
 - Satellite Navigation
 - 2 rear USB connections
- Vauxhall Connect

Comfort and convenience

- Electronic climate control
- Rain-sensitive windscreen wipers (all models)
- Storage pockets on front seat backs
- Automatic anti-dazzle rear-view mirror (all models)

Interior

- Front passenger's seat (six-way adjustable)
- Minstral and jet black fabric leather-effect seat trim inserts
- Jet black fabric side bolsters
- Black facia with red trim inserts
- Black headliner

Styling

- 18-inch bi-colour alloy wheels with red accents and 215/55 R 18 tyres
- Red upper window moulding
- Black Griffin logo and vizor frame
- Black front/rear bumper inserts
- Alloy-effect sports pedals (auto only)

Ultimate



VX_MOK_34531.tif

Petrol/Electric.



VX_MOK_31314_RSX.psd

18-inch alloy wheel (Petrol/Electric).*

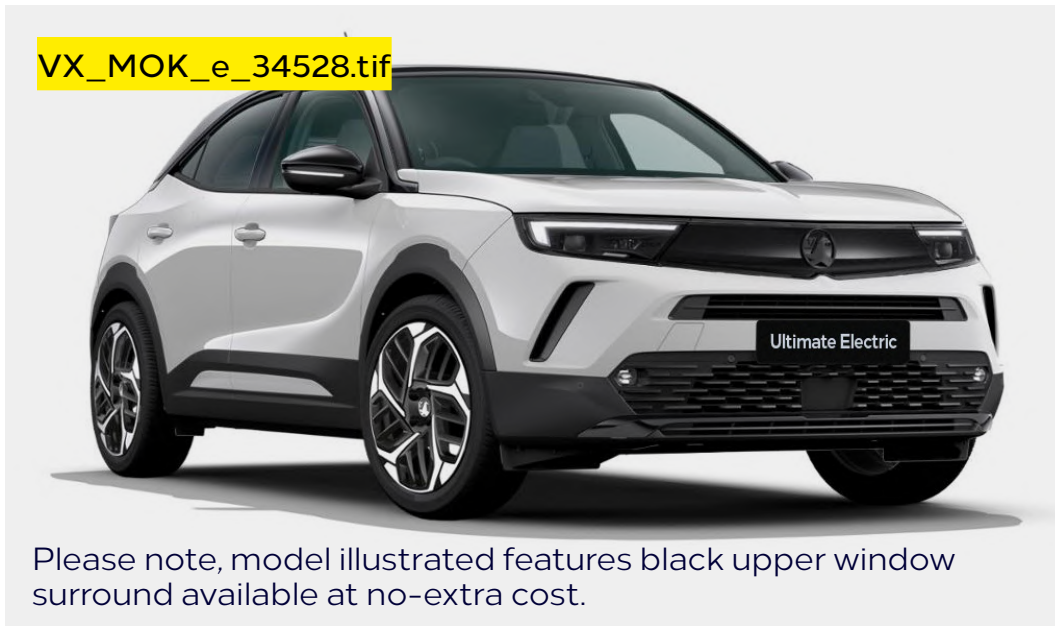

VX_MOK_e_34528.tif

Please note, model illustrated features black upper window surround available at no-extra cost.

Electric Long Range.



VX_MOK_e_34529.tif

18-inch alloy wheel (Electric Long Range).



VX_MOK_34418.tif

Features over and above GS:

PureSense

- IntelliLux LED® Matrix headlights with advanced forward lighting
- LED front fog lights
- Front and rear parking distance sensors
- Adaptive cruise control
- Lane positioning assistant (auto models only)
- Side blind spot alert with flank guard
- Forward collision alert (all speed)
- Automatic headlight levelling system
- Automatic high beam assist

Comfort and convenience

- Electrically foldable door mirrors
- Moveable boot floor
- Keyless entry and start

Interior

- Driver's seat lumbar adjustment (four-way electrical)
- Driver's seat massage function
- Alcantara interior seat trim
- Black premium leather-effect side bolsters
- Black facia with silver trim inserts

Styling

- 18-inch bi-colour alloy wheels with 215/55 R 18 tyres
- 18-inch bi-colour alloy wheels with 195/60 R 18 tyres (Electric Long Range)
- Chrome-effect upper window moulding

*Optional at no-extra cost on Long Range models. For more information see Styling page, click [here](#)

Prices

Electric	LCDV code	Price (£)	VAT (£)	Total (£)	On-the-road RRP (£)	Financial year 2024/25 BiK 20% (£)	WLTP combined CO ₂ (g/km) - LCDV code	Insurance groups
Griffin								
Electric Propulsion (136PS) auto	1GQOSYKESFTOA044	23,783.33	4,756.57	28,540.00	29,495.00	9.81	0	22D
GS								
Electric Propulsion (136PS) auto	1GQOSYHESFTOA044	31,483.33	6,296.67	37,780.00	38,735.00	12.89	0	21E
Electric Propulsion (156PS) auto - Long Range	1GQOSYHZIFTOA044	32,316.67	6,463.33	38,780.00	39,735.00	13.23	0	22E
Ultimate								
Electric Propulsion (136PS) auto	1GQOSYRESFTOA044	33,408.33	6,681.67	40,090.00	41,045.00	13.66	0	22E
Electric Propulsion (156PS) auto - Long Range	1GQOSYRZIFTOA044	34,241.67	6,848.33	41,090.00	42,045.00	14.00	0	23E

Petrol	LCDV code	Price (£)	VAT (£)	Total (£)	On-the-road RRP (£)	Financial year 2024/25 BiK 20% (£)	WLTP combined CO ₂ (g/km)# - LCDV code	Insurance groups
Griffin								
1.2 (100PS) Turbo	1GQOSYKJLKTOA044	16,983.33	3,396.67	20,380.00	21,555.00	106.40	128	14E
1.2 (136PS) Turbo	1GQOSYKP9KTOA044	17,983.33	3,596.67	21,580.00	22,755.00	112.40	127	21D
1.2 (130PS) Turbo auto	1GQOSYKM61TOA044	19,316.67	3,863.33	23,180.00	24,405.00	128.43	137	20D
1.2 (136PS) Hybrid e-DCT6	1GQOSYKJHWTOA044	20,150.00	4,030.00	24,180.00	25,320.00	108.68	109	23D
GS								
1.2 (100PS) Turbo	1GQOSYHJLKTOA044	21,558.33	4,311.67	25,870.00	27,045.00	133.85	128	15E
1.2 (136PS) Turbo	1GQOSYHP9KTOA044	22,558.33	4,511.67	27,070.00	28,245.00	139.85	128	19E
1.2 (130PS) Turbo auto	1GQOSYHM61TOA044	23,891.67	4,778.33	28,670.00	29,895.00	157.71	137	19E
1.2 (136PS) Hybrid e-DCT6	1GQOSYHJHWTOA044	24,725.00	4,945.00	29,670.00	30,810.00	137.57	110	22E
Ultimate								
1.2 (136PS) Turbo	1GQOSYRP9KTOA044	25,241.67	5,048.33	30,290.00	31,465.00	155.95	128	20E
1.2 (130PS) Turbo auto	1GQOSYRM61TOA044	26,575.00	5,315.00	31,890.00	33,115.00	174.88	137	20E
1.2 (136PS) Hybrid e-DCT6	1GQOSYRJHWTOA044	27,408.33	5,481.67	32,890.00	34,030.00	152.05	110	23E

WLTP combined CO₂ (g/km) figures are based on a configured vehicle as per LCDV code for UK with no options fitted.

#Fuel consumption and CO₂ figures are determined according to the WLTP test cycle. CO₂ figures, BiK values and RRP pricing shown above are for a standard vehicle without any additional optional equipment. CO₂ figures are used to calculate Vehicle Excise Duty (VED) for the first registration of the vehicle and BiK. The addition of optional extras could increase the certified CO₂ emission output. This in turn may affect the amount of VED payable upon registration, and, for company car drivers, the P11D value and the amount of Benefit in Kind (BiK) tax payable. Figures shown are for comparison purposes and should only be compared to the fuel consumption and CO₂ values of other cars tested to the same technical standard. The fuel consumption achieved, and CO₂ produced, in real world conditions will depend upon a number of factors including, but not limited to: the accessories fitted (pre and post registration); variations in weather; driving styles and vehicle load. The WLTP (Worldwide Harmonised Light Vehicles Test Procedure) is used to measure fuel consumption and CO₂ figures. Full data relating to WLTP test cycles can be found at: www.vauxhall.co.uk/wltp

Please note: On-the-road recommended retail prices (RRP) include number plates and delivery to Retailer of £900.00 (including £150.00 VAT), 12 months' Vehicle Excise Duty and new vehicle first registration fee of £55.00. Excludes fuel and insurance. Company Car Benefit in Kind (BiK) rates are monthly based on the standard paint price.

PureSense

Model specific features	Griffin	Griffin Electric	GS	GS Electric	Ultimate	Ultimate Electric
Driver assistance						
Cruise control with speed limiter	●	●	●	●	●	●
Enhanced automatic emergency braking with pedestrian detection	●	●	●	●	●	●
Extended traffic sign recognition	●	●	●	●	●	●
Driver drowsiness alert	●	●	●	●	●	●
Lane departure warning with lane keep assist	●	●	●	●	●	●
Forward collision alert (low speed)	●	●	●	●		
Forward collision alert (all speed)					●	●
Lane positioning assistant					auto only	●
Adaptive cruise control					●	●
Side blind spot alert and flank guard					●	●
Rear parking distance sensors	●	●	●	●		
Front and rear parking distance sensors					●	●
Panoramic rear-view camera	●	●	●	●	●	●
Sports switch with engine sound enhancement			●		●	
Exterior lighting						
High beam assist	●	●	●	●	●	●
LED headlights, tail lights and daytime running lights	●	●	●	●		
IntelliLux Matrix LED® headlights with advanced forward lighting and anti-glare beam					●	●
Automatic lighting control with tunnel detection	●	●	●	●	●	●
LED front fog lights					●	●
Automatic headlight levelling system					●	●

Please note, Vauxhall driver assistance systems are intended to support the driver within the system-imminent limitations. The driver remains responsible for the driving task at all times.

PureConnect

Pure Panel digital display

Pure Panel technology makes driving more intuitive, with a flowing design that presents the information you need. With a 10-inch infotainment colour touchscreen and 10-inch digital instrument cluster right in front of you, you can stay focused on the road ahead.

EV information display

- Powerflow display – Informs drivers on the current state of charge and what is being used as the power source, petrol or electric
- Charge display – displays an image of the charge port with the corresponding LED charge indication lights
- e-Save – enables the driver to determine how much battery energy needs to be conserved to ensure that the vehicle reaches its destination when in a zero emission zone
There are three options:
 - 6 mile range reserve
 - 12 mile range reserve
 - Maximum reserve
- Statistics – The Statistics display the average consumption data over a period of time using colour coded graphs
- **Green:** Energy recovered by braking phases and partial recharging by the petrol engine (kWh/mile)
- **Blue:** Energy consumed by the vehicle directly by the battery (kWh/mile)
- **Orange:** Fuel consumption (mpg)

Digital instrumentation

- Digital speedometer and rev counter
- Satellite Navigation display
- Digital fuel gauge with low fuel level warning light
- Digital water temperature gauge with warning light
- Shift-up/down indication light – Indicates when to change gear for optimum fuel economy

Multimedia – Griffin

Features

- 7-inch colour touchscreen
- DAB Digital radio
- RDS with Traffic Programme
- AM/FM stereo radio with 36 station presets
- Six speakers

Media connections

- USB connection
- Bluetooth® A2DP audio streaming (Advanced Audio Distribution Profile)

Mobile phone portal

- Bluetooth® connectivity
- Vehicle microphone
- Handsfree calls via steering wheel controls
- Phone book access – Contacts/last calls/missed calls etc. are mirrored on the display and are easily navigated using the touchscreen (features dependent on mobile phone).
- SMS read out and reply

Smartphone interface

- Apple CarPlay • Android Auto™
- Smartphone projection that allows operations via voice command, touchscreen and buttons to control apps and music playback

Additional features

- Steering wheel mounted audio controls
- Flexible roof-mounted aerial

Multimedia Pro Navi – GS/Ultimate

Features over Multimedia

- 10-inch colour touchscreen • Satellite navigation system
- 2D/3D street level mapping • European coverage
- Points-of-interest search • Map updates via USB

Driver information

Driver information display

(centrally located in instrument cluster)

- Total mileage • Service-due indicator
- Oil life • Tyre pressure monitoring system

Multi-function trip computer

(displayed on digital instrument cluster)

- Trip mileage • Vehicle range based on remaining fuel
- Average speed • Average fuel economy
- Instantaneous fuel economy • Driving time

Digital central facia display

(format dependent on infotainment unit)

- Audio information
- Digital clock with automatic RDS time adjustment
- Outside air temperature with ice warning function
- Additional features dependent on infotainment unit

Model specific features	Griffin	Griffin Electric	GS	GS Electric	Ultimate	Ultimate Electric
Driver information						
7-inch digital instrument cluster (centrally located in instrument panel)	●	●				
12-inch digital instrument cluster (centrally located in instrument panel)			●	●	●	●

Vauxhall Connect



Safety

The more you know, the safer your journey – that's why our smart tech and connected services keep you constantly updated on what's going on inside and outside your vehicle.

Peace of mind

- Emergency call (SOS e-call)
- Breakdown call (b-call)



e-Remote control

Want seamless charging and added levels of comfort? Use e-Remote to schedule charging times, keep an eye on your range and even pre-set your vehicle's cabin temperature before you get in.

Convenience

- E-remote control (Electric only)**
- Remote check of battery level, programming and charge management
- Pre-conditioning of vehicle temperature

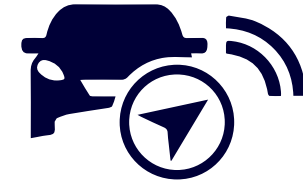

Live navigation plus†

With real-time directions and traffic information from the leading European GPS provider, TomTom®, every journey will be a breeze.

- TomTom® services
- Real time traffic news
- Parking prices and availability
- Weather forecast on your journey
- Natural voice control
- Fuel prices at petrol stations
- Search for charging stations
- Quick search for points of interest
- Road safety alerts



Maintenance

Connected services are here for you – even when things go wrong. Our Intelligent Telemaintenance service monitors the key functions of your vehicle – and notifies you as soon as something needs attention.

- Vehicle status and information**
- Maintenance alerts, fuel level, average fuel consumption and mileage

Vauxhall Connect* is the smart way to stay connected while on the road. Innovative technology systems and related services keep our drivers safe and provide an exciting, efficient yet safe trip.

Download
MyVauxhall now!



Explore MyVauxhall

Ready to make life easier? Meet MyVauxhall – your one-stop shop for everything Vauxhall. Plan journeys from the comfort of your armchair. View your next scheduled service, book a vehicle repair, access your handbook and much more!

Also if you drive an electric vehicle or plug-in hybrid, you'll love our e-Remote Control app feature. Use it to pre-condition your cabin temperature before journeys – and maximise your charge. Or pre-schedule charging times at night, and benefit from cheaper electricity.

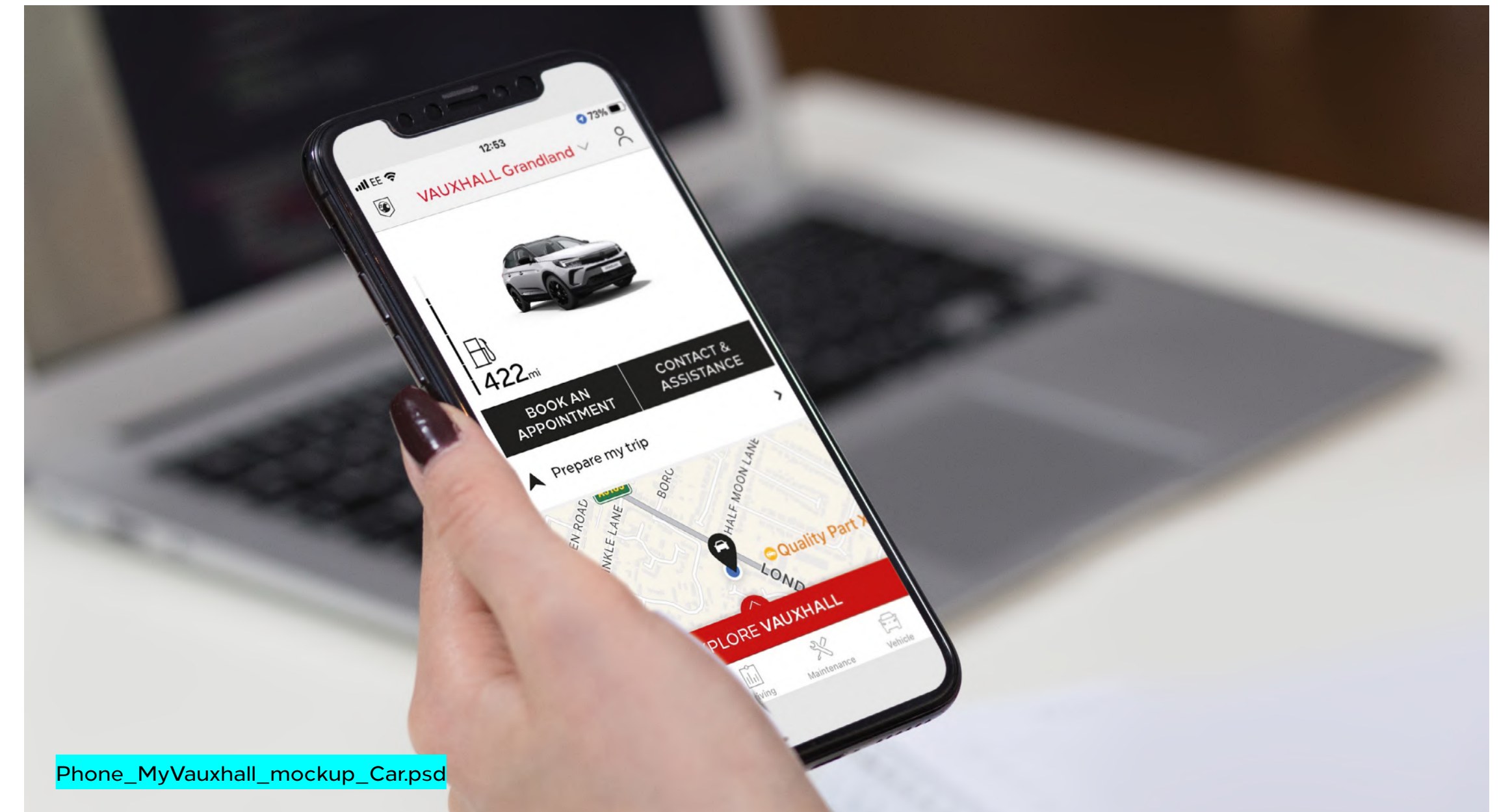

Phone_MyVauxhall_mockup_Car.psd

*Standard on GS Electric and Ultimate models only. Subject to subscription – after you have taken delivery of your vehicle, please subscribe on: connect.vauxhall.co.uk **via MyVauxhall App. †Standard on models with Satellite Navigation only. Additional terms and conditions apply to connected services, including customer acceptance of location sharing prior to activation.

For more information visit vauxhall.co.uk/discover/myvauxhall.html

Comfort and convenience

Model specific features/option	Griffin	Griffin Electric	GS	GS Electric	Ultimate	Ultimate Electric
Interior convenience						
Front 12-volt electrical accessory socket	●	●	●	●	●	●
Reach and rake-adjustable steering	●	●	●	●	●	●
Steering wheel mounted audio controls	●	●	●	●	●	●
Front USB connection	●	●	●	●	●	●
Rain-sensitive windscreen wipers	auto only	auto only	●	●	●	●
Front centre armrest with storage	●	●	●	●	●	●
Automatic anti-dazzle rear-view mirror	auto only	auto only	●	●	●	●
Storage pockets on front seat backs			●	●	●	●
2 rear USB connections			●	●	●	●
Moveable boot floor	●	●			●	●
Keyless entry and start					●	●
Heating and ventilation						
Air conditioning	●					
Electronic climate control		●	●	●	●	●
Heated steering wheel	●	●	●	●	●	●
Heated front seats	●	●	●	●	●	●
Heat pump		£350		£350		£350
Interior lighting						
Interior courtesy light/Front map reading lights/Luggage compartment lighting	●	●	●	●	●	●
Exterior convenience						
Electrically adjustable/heated door mirrors	●	●	●	●	●	●
Electrically foldable door mirrors with puddle light					●	●
Provision for spare wheel fitment – spare wheel is Retailer-fit, deletes emergency tyre inflation kit	£20*		£20*		£20*	

*Optional at extra cost including VAT.

Safety and security

Model specific features	Griffin	Griffin Electric	GS	GS Electric	Ultimate	Ultimate Electric
Security						
Remote control central locking	●	●	●	●	●	●
Remote control ultrasonic security alarm system			●	●	●	●
Airbags						
Driver's airbag/Front passenger's airbag/Front seat side-impact airbags/ Full-size curtain airbags	●	●	●	●	●	●
Braking						
Hill start assist	●	●	●	●	●	●
Safety						
Deactivation switch for front passenger's front and side-impact airbags	●	●	●	●	●	●
ISOFIX child seat mountings incorporating top tether anchor points located on outer rear seats (does not include child seat)	●	●	●	●	●	●
Child-proof locks on rear doors	●	●	●	●	●	●
Tyre pressure						
Tyre pressure monitoring system	●	●	●	●	●	●



Hill start assist.



ISOFIX child seat mountings.

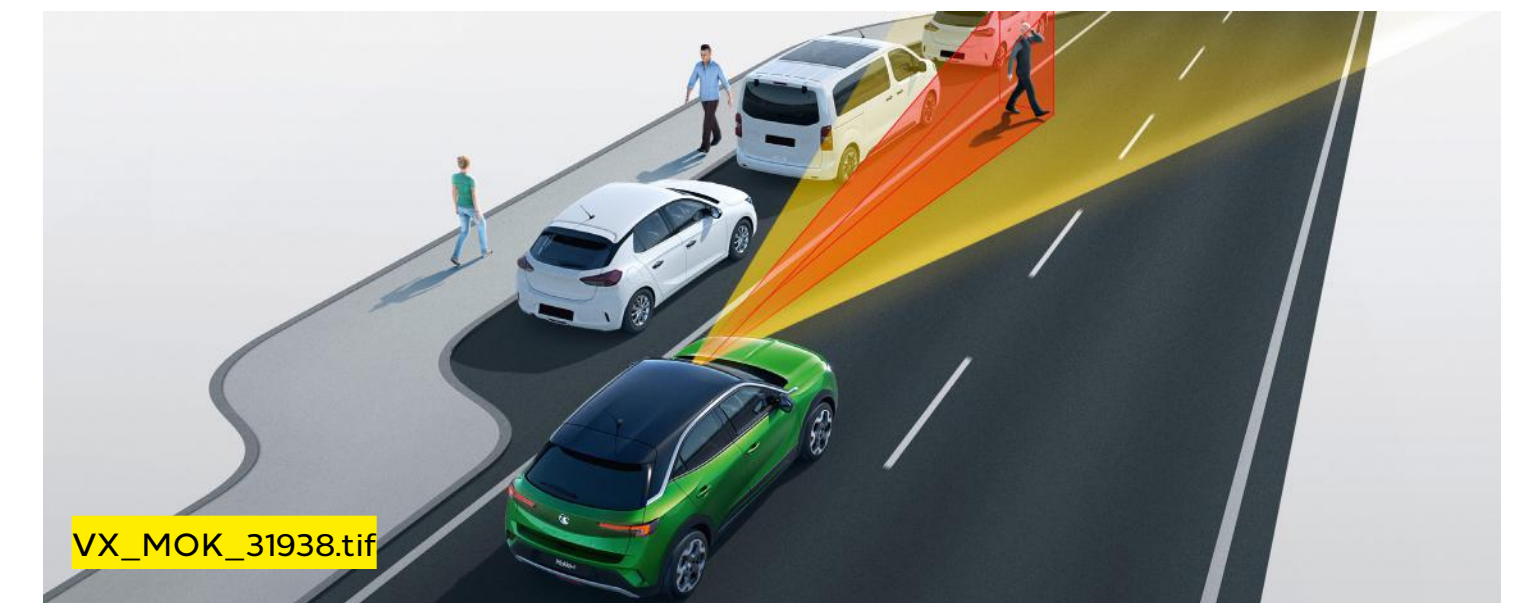

Automatic emergency braking (see PureSense page for details).

Styling

Model specific features/options	Griffin	Griffin Electric	GS	GS Electric	Ultimate	Ultimate Electric
Exterior styling						
Dark-tinted rear windows	●	●	●	●	●	●
Black Griffin logo and vizer frame			●	●	●	●
Chrome-effect Griffin logo and black vizer frame	●	●				
Body coloured front/rear bumper inserts	●	●				
Black front/rear bumper inserts			●	●	●	●
Body-colour front and rear bumpers	●	●	●	●	●	●
Body-colour door handles	●	●	●	●	●	●
Black door mirror housings	●	●	●	●	●	●
Integrated black tailgate spoiler	●	●	●	●	●	●
18-inch bi-colour alloy wheels with 215/55 R 18 tyres			No-cost	No-cost		No-cost*
Interior styling						
Alloy-effect sports pedals (auto only)			●	●	●	●
Roof and window moulding colours						
Body-coloured roof			No-cost	No-cost	No-cost	No-cost
Black roof (Not available with Carbon Black)	●	●	●	●	●	●
Chrome-effect window moulding	●	●			●	●
Red upper window moulding			●	●		
Black upper window moulding			No-cost	No-cost	No-cost	No-cost

*Optional on Long Range models only.

Exterior colours

Arctic White (POWP)*
Brilliant paint



VX_MOK_34026.tif

Contrast Grey (MOF4)**
Two-coat metallic paint £600



VX_MOK_34030.tif

Voltaic Blue (MOAV)†
Two-coat metallic paint £600



VX_MOK_34027.tif

Carbon Black (M09V)**
Two-coat metallic paint £600



VX_MOK_34029.tif

Iconic Green (MOHU)†
Two-coat premium metallic paint £700



VX_MOK_34031.tif

Cosmic Red (MOPY)†
Two-coat premium metallic paint £700



VX_MOK_34028.tif

The colours reproduced may vary slightly from the actual paint colour. As a result they should be used as a guide only. Your Vauxhall Retailer has a comprehensive display of our paint samples. Please note, vehicles illustrated are not model specific and are for illustrative purposes only.

*Standard exterior paint. **Optional at extra cost including VAT. †Optional at extra cost including VAT. Not available on GS models.

PureEnergy – Electric

Single-speed electronic drive selector

As the motor is an all-electric single-speed drive unit, there is no need for multiple gears. Instead, the shifter lets the driver select from the following:

- Park • Reverse • Neutral • Drive
- Braking (for increased regenerative braking)

Drive mode selector

The driver can determine the driving style by selecting one of the following modes:

- **Normal:** for a balanced drive that offers a compromise between performance and energy efficiency
- **Sport:** for a dynamic drive with a responsive throttle and the highest top speed and torque
- **ECO:** for maximum range and energy efficiency. The ECO mode deactivates all unnecessary energy-consuming features and reduces the top speed, torque and overall performance

Charging

Mokka Electric is fitted with a 11kW on board charger and is also equipped with a Mode 3 cable as standard. Additional charging accessories are available at extra cost. For more details please consult your local Retailer.

The charging flap's Padlock LED lights up when the cable is correctly plugged in and locked and then acts as a user interface to show the charging status via coloured LED lights:

- **White:** welcome light that helps to light up the area, especially useful in dark conditions
- **Flashing green:** charging in progress
- **Solid green:** charging complete
- **Solid blue:** delayed charging toggled; changes to flashing green when charging commences
- **Solid red:** malfunction

The driver may also choose from two settings:

- **Immediate charging (the standard setting):** Starts charging as soon as the vehicle is docked for charging
- **Delayed charging:** This is especially useful for when cheaper electric rates are desired, e.g. charging at night. Simply enter a charging start time

Please note, EV range assumes that vehicle has been pre-conditioned prior to journey. This function can be accessed either via MyVauxhall App or by using the infotainment system.

Drivetrain – Electric	50kWh	54kWh
CO ₂ emissions	0g/km	
Maximum power	100kW (136PS)	115kW (156PS)
Maximum torque	260Nm (192lb. ft.)	
Acceleration 0 – 62mph	9.2 sec	9.0 sec
Maximum speed	93mph	
Transmission	Automatic electric drive with fixed gear ratio	
Service interval	Initial inspection at 8,000 miles/1 year (whichever comes sooner). Thereafter 16,000 miles/2 years (whichever comes sooner)	
Battery	50kWh	54kWh
Battery capacity	50kWh	54kWh
AC on-board charger speed	11kW	
EAER (WLTP)*	209 miles	252 miles
Energy consumption (WLTP)*	15.8 – 16.2kWh/100km	15.3 – 15.5kWh/100km
Battery warranty	8 years/100,000 miles/70% capacity	
Charging (Supply)	Socket	Charge Time (0 – 100%)
AC current – Domestic 3 pin socket (2.3kW)	Type 2	21h 45m
AC current – Home wallbox or public charger (7kW)	Type 2	7h 30m
AC current – Public charger (11kW)	Type 2	5h
DC current – Rapid charger (100kW)	CCS	30m (0 – 80%)
Charging cables	11kW on-board charger	
Mode 3, 3-phase 22kW cable	Standard	

The Mokka Electric is a battery electric vehicle requiring mains electricity for charging. Range data given has been determined according to WLTP test procedure methodology. The figures shown are intended for comparability purposes only and should only be compared to other cars tested to the same technical standard. The range you achieve under real world driving conditions will depend upon a number of factors, including but not limited to: the accessories fitted (pre and post registration); charging frequency; personal driving style; vehicle load and route characteristics; variations in weather; heating/air conditioning; pre-conditioning and battery condition. For more information, contact your local Vauxhall Retailer.

EAER = Equivalent All Electric Range. *WLTP preliminary.

PureEnergy – Petrol

Petrol engines	1.2 (100PS) Turbo	1.2 (136PS) Turbo with 6-speed manual	1.2 (130PS) Turbo with 8-speed automatic	Hybrid 1.2 136PS e-DCT6 Dual Clutch 6-speed
Capacity	1199cc	1199cc	1199cc	1199cc
Maximum power	100PS (75kW) @ 5500rpm	136PS (100kW) @ 5500rpm	130PS (96kW) @ 5500rpm	136PS (100kW) @ 5500rpm
Maximum torque	205Nm (151lb.ft.) @1750rpm	230Nm (169lb.ft.) @1750rpm	230Nm (169lb.ft.) @1750rpm	230Nm (169lb.ft.) @1750rpm
Configuration	3 cylinders, 4 valves per cylinder, double overhead camshafts	3 cylinders, 4 valves per cylinder, double overhead camshafts	3 cylinders, 4 valves per cylinder, double overhead camshafts	3 cylinders, 4 valves per cylinder, double overhead camshafts
Fuel/induction system	Turbocharger with intercooler. Multi-point sequential fuel injection	Turbocharger with intercooler. Multi-point sequential fuel injection	Turbocharger with intercooler. Multi-point sequential fuel injection	Turbocharger with intercooler. Multi-point sequential fuel injection
Emission compliance	Euro 6d (6.4)	Euro 6d (6.4)	Euro 6d	Euro 6d
Service interval	12,500 miles or 1 year (whichever occurs sooner)	12,500 miles or 1 year (whichever occurs sooner)	12,500 miles or 1 year (whichever occurs sooner)	12,500 miles or 1 year (whichever occurs sooner)

Performance, fuel economy and emissions	Performance (manufacturer's figures)		Fuel economy mpg (litres/100km) [#]		CO ₂ emissions g/km [#]		Vehicle Excise Duty*		BiK rates from – 2024/25 tax year
	Maximum speed (mph)	Acceleration 0 – 60mph (sec)	Combined Low	Combined High	Combined Low	Combined High	First year rate	Standard rate	
1.2 (100PS) Turbo	116	10.6	50.5 (5.5)	51.3 (5.6)	124	125	£220	£190	30%
1.2 (136PS) Turbo	125	9.1	51.3 (5.5)	51.4 (5.5)	124	125	£220	£190	30%
1.2 (130PS) Turbo automatic	124	9.2	47.8 (5.9)	47.9 (5.9)	132	133	£270	£190	31%
1.2 (136PS) Hybrid e-DCT6	127	8.4	57.6 (4.9)	57.6 (4.9)	109	110	£185	£190	26%

[#]Figures shown are for comparison purposes and should only be compared to the fuel consumption and CO₂ values of other cars tested to the same technical standard. The fuel consumption achieved, and CO₂ produced, in real world conditions will depend upon a number of factors including, but not limited to: the accessories fitted (pre and post registration); variations in weather; driving styles and vehicle load. The WLTP (Worldwide Harmonised Light Vehicles Test Procedure) is used to measure fuel consumption and CO₂ figures. The CO₂ figures display a range to reflect the highest value for the highest emitting version with all available options added, through to a minimum value to represent the lowest emitting version in standard specification.

*Correct at time of publication.

Specifications

Transmissions

Six-speed manual gearbox

Petrol engines: 1.2 (100PS) Turbo/
1.2 (136PS) Turbo

Eight-speed automatic transmission

Petrol engine: 1.2 (130PS) Turbo

This transmission enables increased drive comfort with improved fuel economy and features a manual shifting mode. For a more engaging drive, the driver can select gears using the shift paddles located on the steering wheel.

Drive mode selector (auto-only)

The driver can determine the driving style by selecting one of the following modes:

- **Normal:** for a balanced drive that offers a compromise between performance and energy efficiency
- **Sport:** for a dynamic drive with a responsive throttle and the highest top speed and torque
- **ECO:** for maximum range and energy efficiency. The ECO mode deactivates all unnecessary energy-consuming features and reduces the top speed, torque and overall performance

Steering

- Single pinion electrical power steering

Brakes

- Anti-lock Braking System (ABS)
- Electronic brakeforce distribution
- Emergency brake assist
- Cornering brake control
- Straight line stability control

Petrol engines

- Front ventilated discs: 283mm diameter
- Rear drums: 249mm diameter

Electric motor

- Front ventilated discs: 302mm diameter
- Rear discs: 268mm diameter

Fuel tank capacity

- 44 litres – All models

Exterior dimensions – mm (inches)	Mokka	Mokka Electric
Length	4151 (163.42)	4151 (163.42)
Width (with mirrors)	1791 (70.52)	1791 (70.52)
Height	1531 (60.3)	1531 (60.3)
Wheelbase	2561 (100.83)	2561 (100.83)
Loadspace dimensions – mm (inches)	Mokka	Mokka Electric
Maximum length behind rear seats	667 (26.3)	667 (26.3)
Maximum length rear seats folded	1418 (55.8)	1418 (55.8)
Maximum width	1021 (40.2)	1021 (40.2)
Maximum height	780 (30.7)	780 (30.7)
Luggage capacities – Litres (cu.ft.)	Mokka	Mokka Electric
Rear seats up (under luggage compartment cover)	350 (12.37)	310 (10.9)
Rear seats folded (to roof)	1105 (39.0)	1060 (37.4)
Weights and towing data – kg	Gross vehicle weight	Maximum towing weights. Trailer with brakes (without brakes)
1.2 (100PS) Turbo	1700	1200 (620)
1.2 (136PS) Turbo	1715	1200 (620)
1.2 (130PS) Turbo automatic	1740	1200 (640)
1.2 (136PS) Hybrid e-DCT6		

Please note: Gross vehicle weight is the total permissible weight of the vehicle including passengers and their luggage. The maximum roof rack loading should not exceed 70kg. The maximum towing weights are based on the ability of the car, with two occupants of 75kg each, to restart on a 12% gradient, which is approximately 1 in 8.3, at sea level. The permitted trailer load applies up to the specified incline and up to an altitude of 1000 metres above sea level. The permissible gross train weight decreases by 10% for every 1000 metres of additional altitude. At altitudes above 1500 metres, the engine output may drop with a corresponding reduction in towing capability. Any extra weight, such as luggage or additional passengers, should be deducted from the maximum towing weight. With a trailer fully loaded, maximum noseweight should not exceed 55kg. Always fit Vauxhall towing attachments and accessories available from your Vauxhall Retailer. They are designed specifically for Vauxhall models and carry a 12-month guarantee. During trailer towing do not exceed a maximum speed of 60mph. This speed limit is also applicable in countries with higher permitted speeds for trailer-vehicle combinations. Pay attention to the local speed limits. For trailers with low driving stability and caravans the use of an oscillation damper is strongly recommended.

Company car driver and fleet information

Benefit in kind company car taxation*

The car benefit charge will be the car's list price (including VAT, options and accessories fitted, delivery to Retailer and number plates, but excluding Vehicle Excise Duty and new vehicle first registration fee) multiplied by the percentage charge for the CO₂ emissions band in which the car falls (see table opposite). Multiply this figure by your personal income tax rate (20%** for Basic Rate, 40%** for Higher Rate) to calculate your annual benefit in kind tax liability.

Generic example:

ELECTRIC vehicle: 0g/km CO₂

On-the-road RRP	£27,305.00
Deduct: Vehicle Excise Duty	£0.00
New vehicle first registration fee	-£55.00
Effective list price	£27,250.00
Add: Optional two-coat metallic paint	£600.00
List price for tax purposes (P11D value)	£27,850.00
Car benefit charge 2024 – 25 tax year (2%)	£557.00
Benefit in kind tax liability	
Basic Rate (20%) tax payer	£111.40
Higher Rate (40%) tax payer	£222.80

*Please note this Price Guide provides taxation information as a guide only. Vauxhall does not provide taxation guidance. Drivers should always take professional advice on their own tax position.

**Excludes residents of Scotland.

BiK for Scottish Residents

Effective 6 April 2018 the Scottish Government have introduced their own BiK taxation structure. This only applies to Company Car Drivers that are Scottish taxpayers. HMRC will determine whether or not an individual is a Scottish taxpayer based on where their main place of residence is.

The BiK rates for Scotland are:

- Over £12,570 – £14,732 Starter Rate 19%
- Over £14,732 – £25,688 Basic Rate 20%
- Over £25,688 – £43,662 Intermediate Rate 21%
- Over £43,662 – £150,000 Higher Rate 41%
- Above £150,000 Top Rate 46%

To calculate your own personal liability, click the link [Vauxhall BiK Tool](#)

CO ₂ (g/km)	Electric range (miles)	% 2024 – 25 tax year
0	-	2%
1 – 50	130+	2%
1 – 50	70 – 129	5%
1 – 50	40 – 69	8%
1 – 50	30 – 39	12%
1 – 50	<30	14%
51 – 54	-	15%
55 – 59	-	16%
60 – 64	-	17%
65 – 69	-	18%
70 – 74	-	19%
75 – 79	-	20%
80 – 84	-	21%
85 – 89	-	22%
90 – 94	-	23%
95 – 99	-	24%
100 – 104	-	25%
105 – 109	-	26%
110 – 114	-	27%
115 – 119	-	28%
120 – 124	-	29%
125 – 129	-	30%
130 – 134	-	31%
135 – 139	-	32%
140 – 144	-	33%
145 – 149	-	34%
150 – 154	-	35%
155 – 159	-	36%
160+	-	37%

Vehicle Excise Duty†

The amount of Vehicle Excise Duty (road fund licence) payable on new cars varies depending on the level of carbon dioxide (CO₂) emissions produced by the vehicle. CO₂ emissions are measured in grams per kilometre (g/km) travelled and divided into 13 charging bands shown in the table below.

A 'first year rate' of Vehicle Excise Duty is payable on all new cars and in subsequent years the amount payable reverts to a different rate. Also, for vehicles with a list price over £40,000, including factory-fitted options, an additional £410 is payable for five years after registration.

VED Band	CO ₂ (g/km)	First year rate Petrol/ Diesel	First year rate Hybrid/ Electric
A	0	£0	£0
B	1 – 50	£10	£0
C	51 – 75	£30	£20
D	76 – 90	£135	£125
E	91 – 100	£175	£165
F	101 – 110	£195	£185
G	111 – 130	£220	£210
H	131 – 150	£270	£260
I	151 – 170	£680	£670
J	171 – 190	£1,095	£1,085
K	191 – 225	£1,650	£1,640
L	226 – 255	£2,340	£2,330
M	Over 255	£2,745	£2,735

†Correct at time of issue.

Fleet Toolbox

The Fleet Toolbox has a host of useful calculators, comparators, interactive listings and information.

Click the link for more information

[Vauxhall Fleet Tool Box](#)

Contact Vauxhall Fleet

Please contact one of our dedicated sales teams who will be happy to help with your particular enquiry.

Fleet Decision Makers

Depending on the size of your fleet of vehicles, we have a dedicated team to handle your enquiries. The lines are open Monday to Friday excluding Bank Holidays.

1 – 24 vehicles

Call: 0203 885 4560 (8:30am – 5:00pm)

Email: enquiries@stellantis-fleet.co.uk

50+ vehicles

Call: 0203 885 4562 (8:30am – 5:00pm)

Email: enquiries@vauxhallfleet.co.uk

Special Vehicles (Police, Fire and Ambulance)

Email: psvo@stellantis.com

For more information visit vauxhall.co.uk/fleet

Further information

On-the-road prices

To eliminate uncertainty about hidden costs when buying a new car, Vauxhall publishes on-the-road recommended retail prices (RRP) and these are shown in the pricing tables within this price guide. These prices include VAT, number plates and delivery to Retailer of £900.00 (including £150.00 VAT), 12 months' Government Vehicle Excise Duty and the DVLA new vehicle first registration fee of £55.00.*

Please note: The on-the-road recommended retail price (RRP) does not include fuel supplied by the Retailer, motor insurance or any other goods or services supplied by agreement between the Retailer and the customer.

Price protection

Order a new Vauxhall for build in the current model year (as confirmed by your Retailer) for delivery no more than three months in advance and the price you are quoted is the price you pay. This is irrespective of any subsequent price rises between placing your order and delivery of your new car, but you must take delivery as soon as the car is available. Please note: Vauxhall Motors Limited is not liable for price adjustments caused by Government changes in the rate of VAT (currently 20%), Vehicle Excise Duty, DVLA new vehicle first registration fee or by any other applicable legislation or regulations.

Customer Care Commitment

For added peace of mind, Vauxhall has an innovative Customer Care Commitment that offers the following:

- Three-year vehicle warranty consisting of a one year/unlimited mileage manufacturer's warranty and a second and third year manufacturer's warranty with a 60,000 miles limitation

- Vauxhall Assistance for 12 months from first registration
- Six years' body panel anti-perforation warranty

Please note: Warranty is only available on vehicles sourced from Vauxhall Motors Limited. Terms and conditions apply – please see your Vauxhall Retailer for details.

Vauxhall Assistance

Vauxhall Assistance is provided automatically with every new Vauxhall for 12 months from first registration and covers everything from accident assistance, roadside recovery and 'at home' service to flat tyres. For even more peace of mind, on fully electric models, the cover is extended** to 3 years. Even more reason for you to stay calm and let us take care of everything should the need arise. With Vauxhall Assistance help is literally just a free† phone call away, 24 hours a day, 365 days a year!



Leasys UK

Leasys is the proud Business Contract Hire partner of Vauxhall and consequently, can provide quick vehicle delivery to keep your business mobile. Specialised in Medium to Long-Term Leasing options and Fleet Management solutions for businesses of all sizes, [Leasys](#) lead mobility by offering sustainable and innovative solutions designed around customers, for a best-in-class experience. Their team of experts can personally support you and provide dedicated consultation. [Leasys](#) is equally owned by Stellantis and Crédit Agricole Consumer Finance and is a member of the British Vehicle Rental and Leasing Association (BVRLA). For further information, please contact your local Vauxhall Retailer or visit [leasys.com/uk](#)

In the event of an accident

Vauxhall Accident Management helps keep you mobile following an accident. Benefits include vehicle recovery, Vauxhall-approved repairs and contacting your insurer. For more details, visit [vauxhall.co.uk/AccidentManagement](#)

Vauxhall Flexcare – Service Plans and Extended Warranty

Designed for your peace of mind. A collection of extended warranty and service plans to match the way you drive.

Extended Warranty

An extended warranty for your Vauxhall offers you similar cover for material or manufacturing defects beyond the original warranty period on the vehicle. By choosing an official Vauxhall Extended Warranty, we guarantee that any repairs you need are carried out by Vauxhall trained technicians using genuine Vauxhall parts.

Service Plans

There's no need to worry about budgeting for your next service. Simply take out a Vauxhall Fixed Price Service Care Plan. You can then focus on the more important things in life, knowing your servicing costs are taken care of. For more information, click on the link below or call us on **0345 600 2065**. See [vauxhall.co.uk/discover/here-for-you.html](#)

Vauxhall Service Club

A world of servicing, repair and accessory benefits with Vauxhall Service Club is available for all Vauxhall owners, and it's free to join via the MyVauxhall app (terms and conditions apply). For a list of benefits and details on how to join visit: [vauxhall.co.uk/serviceclub](#)

Vauxhall Insurance with added reassurance

Join the family or find out more about Vauxhall Insurance Services by contacting our insurance team on **0330 678 1130**††, or visit: [vauxhall.co.uk/offers-finance/insurance.html](#)

Vauxhall Accessories

From the small things that make life easier to the big things that make life exciting – personalise your Vauxhall with Vauxhall Accessories. So what are you looking for? A device holder, roof box, or even splash guards? Whatever it is we've got the solution for you. With our huge accessory range, all tailor-made for your Vauxhall and come with a full year's warranty. For further details visit your local Retailer or see [vauxhall.co.uk/owners/accessories.html](#)

Protecting the environment

Vauxhall's commitment to the environment is demonstrated by our products' many environmental awards. For even more information on Vauxhall's efforts to achieve an environmentally sustainable future, and how to dispose of your end-of-life vehicle, see [vauxhall.co.uk/recycling](#)

For more product information

For further information on the Vauxhall range or location of your nearest Vauxhall Retailer please call **0800 026 0034**. Alternatively, details can be found on our website at [vauxhall.co.uk](#)

VAUXHALL

For more information call **0800 026 0034**

For Fleet enquiries call **0203 476 2268**

Discover the full Vauxhall range at **[vauxhall.co.uk](https://www.vauxhall.co.uk)**

Join us online

The invoice price, including delivery to Retailer, factory-fitted options, accessories fitted by the Retailer and number plates, is subject to VAT. Some feature descriptions in this guide may refer to, and some illustrations may show, optional equipment not included in the standard delivery. The information contained in this guide was accurate at the time of publication. We reserve the right to make changes in design and equipment. Please note that Vauxhall Retailers are not the agents of Vauxhall Motors Limited and are not authorised to bind Vauxhall Motors Limited by any specific or implied undertaking or representation. It is advisable to ensure that your motor insurance policy provides adequate cover for additional fitted options and accessories. The colours in this guide are only approximate actual colours. Illustrated optional equipment is available at extra charge. Availability, technical features and equipment provided on our vehicles can vary by model. For precise information on the equipment provided on our vehicles, please contact your local Vauxhall Retailer.

Price and Specification Guide
3 April 2024 | Model Year 2024B



Crossland

Contents

To find the information you want use the links below to navigate around the guide:

[Ultimate models](#)

[Prices](#)

[Vauxhall PureSense](#)

[Vauxhall PureConnect](#)

[Comfort and convenience](#)

[Safety and security](#)

[Styling](#)

[Exterior colours](#)

[Vauxhall PureEnergy](#)

[Specifications](#)

[Company car information](#)

[Further information](#)

At Vauxhall, we believe great cars are for everyone.

We believe technology works best when it's not just smart but is also simple and intuitive.

Where everyone can keep themselves and their loved ones safer on the road and can stay connected to the things that matter most, simply

and easily. We call it Vauxhall Pure Technology. No gimmicks, nothing complicated, just technology that makes driving better, easier and more exciting, for everyone.



Ultimate



17-inch alloy wheel.



Standard features include:

PureSense

- LED headlights and tail lights
- LED daytime running lights
- LED front fog lights
- Automatic lighting control
- Lane departure warning
- Speed sign recognition
- Cruise control with speed limiter
- Hill start assist
- Six airbags
- ISOFIX child seat fixings on outer rear seats
- Side blind spot alert
- Advanced park assist
- Automatic headlight levelling system
- Automatic high beam control with cornering light
- Front and rear parking distance sensors
- Panoramic rear-view camera
- Driver drowsiness alert
- Forward collision alert (all speed)
- Automatic emergency braking with pedestrian detection

PureConnect

- Multimedia Navi Pro infotainment system
 - 8-inch colour touchscreen
 - Satellite navigation
 - 2 x USB connections
 - AM/FM/DAB digital radio
 - Bluetooth®
 - Apple CarPlay/Android Auto™
- 3.5-inch colour instrument display
- Six speakers
- Vauxhall Connect

Comfort and convenience

- Dual-zone electronic climate control
- Remote control security alarm system
- Front centre armrest for driver's seat
- Centre console storage box with sliding lid
- Storage pockets on front seat backs
- Leather-covered steering wheel
- Steering column adjustable for reach/rake
- Steering wheel mounted audio/phone/cruise controls

- 12v front and rear power outlets
- Sliding 60/40 rear seat with centre rear seat armrest
- Rain-sensitive windscreen wipers
- Electrically operated front and rear windows
- Electrically adjustable/heated door mirrors
- Automatic anti-dazzle rear-view mirror
- Emergency tyre inflation kit
- Load floor compartment FlexFloor with cargo under floor divider
- Keyless entry and start
- Power folding door mirrors

Interior

- Ergonomic active driver's and front passenger's seat
 - AGR-approved* (eight-way adjustable)
 - Seat cushion extension
 - Lumbar adjustment (four-way electrical)
- Alcantara seat trim inserts
- Heated front seats
- Heated steering wheel
- Black facia with dark grey trim inserts
- Silver trim inserts on front doors

Styling

- 17-inch diamond-cut bi-colour five twin-spoke alloy wheels with 215/50 R 17 tyres
- Black painted door mirrors
- Black Griffin logo, vizer frame, rear lettering and skid plates
- Dark-tinted rear windows
- Black roof
- Chrome-effect digital instrument cluster surround
- Silver-effect roof rails
- Chrome-effect upper window moulding

*AGR (The Campaign for Healthier Backs) is an independent centre of excellence for ergonomics, based in Germany.

Prices

Petrol	LCDV code	Price (£)	VAT (£)	Total (£)	On-the-road RRP (£)	Financial year 2023/24 BiK 20% (£)	WLTP combined CO ₂ (g/km) [#] - LCDV code	Insurance groups
Ultimate								
1.2 (110PS) Turbo	1GMEAFLL5KT0A0G2	22,483.33	4,496.67	26,980.00	28,205.00	144.05	134	16E
1.2 (130PS) Turbo auto	1GMEAFLM6QT0A0G2	24,266.67	4,853.33	29,120.00	30,345.00	165.11	144	19E

WLTP combined CO₂ (g/km) figures are based on a configured vehicle as per LCDV code for UK with no options fitted.

[#]Provisional fuel consumption and CO₂ figures are determined according to the WLTP test cycle. CO₂ figures, BiK values and RRP pricing shown above are for a standard vehicle without any additional optional equipment. CO₂ figures are used to calculate Vehicle Excise Duty (VED) for the first registration of the vehicle and BiK. The addition of optional extras could increase the certified CO₂ emission output. This in turn may affect the amount of VED payable upon registration, and, for company car drivers, the P11D value and the amount of Benefit in Kind (BiK) tax payable. Figures shown are for comparison purposes and should only be compared to the fuel consumption and CO₂ values of other cars tested to the same technical standard. The fuel consumption achieved, and CO₂ produced, in real world conditions will depend upon a number of factors including, but not limited to: the accessories fitted (pre and post registration); variations in weather; driving styles and vehicle load. The WLTP (Worldwide Harmonised Light Vehicles Test Procedure) is used to measure fuel consumption and CO₂ figures. Full data relating to WLTP test cycles can be found at: www.vauxhall.co.uk/wltp

Please note: On-the-road recommended retail prices (RRP) include number plates and delivery to Retailer of £900.00 (including £150.00 VAT), 12 months' Vehicle Excise Duty and new vehicle first registration fee of £55.00. Excludes fuel and insurance. Company Car Benefit in Kind (BiK) rates are monthly based on the standard paint price.

PureSense

Model specific features	Ultimate
Driver assistance	
Lane departure warning with lane keep assist	●
Speed sign recognition	●
Cruise control with speed limiter	●
Automatic emergency braking with pedestrian detection	●
Driver drowsiness alert	●
Forward collision alert	●
Panoramic rear-view camera	●
Front and rear parking distance sensors	●
Side blind spot alert	●
Advanced park assist	●
Exterior lighting	
LED headlights	●
LED daytime running lights	●
Automatic headlight levelling system	●
Automatic high beam control with cornering light	●
LED front fog lights	●
LED tail lights	●
Interior lighting	
Ambient lighting	●

PureConnect

Multimedia Navi Pro

Features

- Satellite navigation system
- 8-inch colour touchscreen
- 2D/3D street level mapping
- European coverage
- Points-of-interest search
- Map updates via USB
- DAB Digital radio
- RDS with Traffic Programme
- AM/FM stereo radio with 36 station presets
- Six speakers

Media connections

- USB connections
- Bluetooth® A2DP audio streaming (Advanced Audio Distribution Profile)

Mobile phone portal

- Bluetooth® connectivity
- Vehicle microphone
- Handsfree calls via steering wheel controls
- Phone book access – Contacts/last calls/missed calls etc. are mirrored on the display and are easily navigated using the touchscreen (features dependent on mobile phone).
- SMS read out and reply

Smartphone interface

- Apple CarPlay
- Android Auto™
- Smartphone projection that allows operations via voice command, touchscreen and buttons to control apps and music playback

Additional features

- Steering wheel mounted audio controls
- Flexible roof-mounted aerial

Driver information

Driver information display

(centrally located in instrument cluster)

- 3.5-inch colour instrument display
- Trip computer data
- Total mileage
- Service-due indicator
- Oil life
- Tyre pressure monitoring system

Multi-function trip computer

(displayed on driver information display)

- Trip mileage
- Vehicle range based on remaining fuel
- Average speed
- Average fuel economy
- Instantaneous fuel economy

Central facia display

(format dependent on infotainment unit)

- Audio information
- Digital clock with automatic RDS time adjustment
- Outside air temperature with ice warning function
- Additional features dependent on infotainment unit

Vauxhall Connect



Safety

The more you know, the safer your journey – that's why our smart tech and connected services keep you constantly updated on what's going on inside and outside your vehicle.

Peace of mind

- Emergency call (SOS e-call)
- Breakdown call (b-call)



e-Remote control

Want seamless charging and added levels of comfort? Use e-Remote to schedule charging times, keep an eye on your range and even pre-set your vehicle's cabin temperature before you get in.

Convenience

- Remote check of battery level, programming and charge management
- Pre-conditioning of vehicle temperature

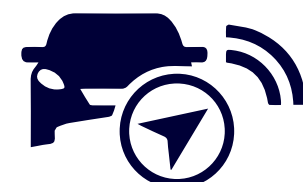

Live navigation plus†

With real-time directions and traffic information from the leading European GPS provider, TomTom®, every journey will be a breeze.

- TomTom® services
- Real time traffic news
- Parking prices and availability
- Weather forecast on your journey
- Natural voice control
- Fuel prices at petrol stations
- Search for charging stations
- Quick search for points of interest
- Road safety alerts



Maintenance

Connected services are here for you – even when things go wrong. Our Intelligent Telemaintenance service monitors the key functions of your vehicle – and notifies you as soon as something needs attention.

- Vehicle status and information**
- Maintenance alerts, fuel level, average fuel consumption and mileage

Vauxhall Connect* is the smart way to stay connected while on the road. Innovative technology systems and related services keep our drivers safe and provide an exciting, efficient yet safe trip.

Download
MyVauxhall now!



Explore MyVauxhall

Ready to make life easier? Meet MyVauxhall – your one-stop shop for everything Vauxhall. Plan journeys from the comfort of your armchair. View your next scheduled service, book a vehicle repair, access your handbook and much more!

Also if you drive an electric vehicle or plug-in hybrid, you'll love our e-Remote Control app feature. Use it to pre-condition your cabin temperature before journeys – and maximise your charge. Or pre-schedule charging times at night, and benefit from cheaper electricity.

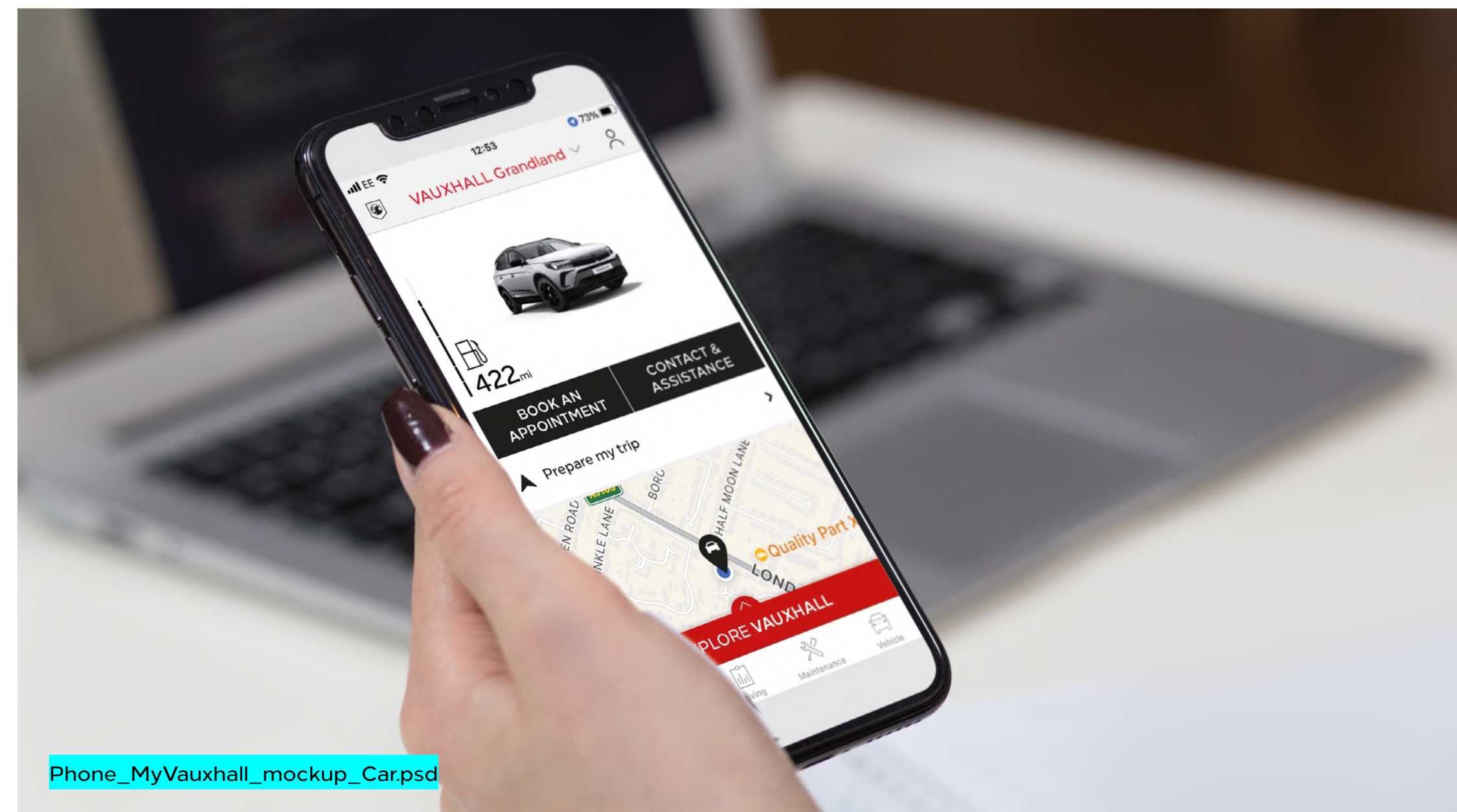

Phone_MyVauxhall_mockup_Car.psd

*Subject to subscription – after you have taken delivery of your vehicle, please subscribe on: connect.vauxhall.co.uk**via MyVauxhall App.†Additional terms and conditions apply to connected services, including customer acceptance of location sharing prior to activation.

For more information visit vauxhall.co.uk/discover/myvauxhall.html

Comfort and convenience

Model specific features/option	Ultimate
Interior convenience	
Reach and rake-adjustable steering	●
Steering wheel mounted audio/phone/cruise controls	●
Automatic anti-dazzle rear-view mirror	●
Rain-sensitive windscreen wipers	●
Electrically operated front and rear windows	●
Electrically foldable/adjustable/heated door mirrors	●
Front centre armrest for driver's seat	●
Centre console storage box with sliding lid	●
12v rear seat power outlet	●
Storage pockets on front seat backs	●
Versatility Pack – Sliding 60/40 rear seat back with centre rear seat armrest/Centre rear head restraint/Load floor compartment FlexFloor with cargo under floor divider	●
Keyless entry and start	●
Heating and ventilation	
Dual-zone electronic climate control	●
Winter Pack – Heated front seats/Heated steering wheel	●
Exterior convenience	
Provision for spare wheel fitment – spare wheel is Retailer-fit, deletes emergency tyre inflation kit	£20*

Safety and security

Model specific features	Ultimate
Airbags	
Driver's airbag and front passenger's airbag	●
Front seat side-impact airbags	●
Full-size curtain airbags	●
Braking	
Hill start assist – Briefly maintains rear brake pressure to stop the vehicle rolling back on an incline	●
Child safety	
Deactivation switch for front passenger's front and side-impact airbags	●
ISOFIX child seat mountings incorporating top tether anchor points located on outer rear seats (does not include child seat)	●
Security	
Locking wheel bolts for alloy wheels	●
Remote control central locking	●
Remote control security alarm system	●



Hill start assist.



ISOFIX child seat mountings.

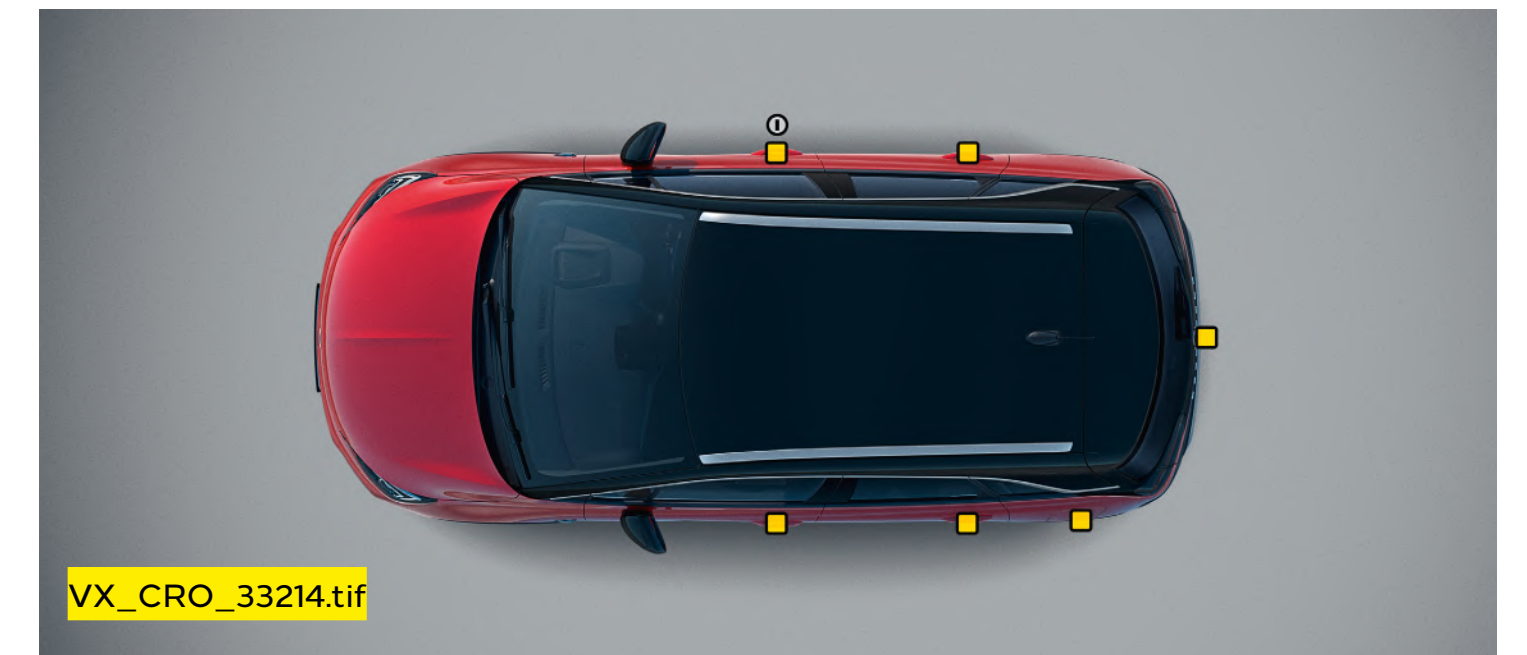

Remote control central locking.

Styling

Model specific features/option	Ultimate
Exterior styling	
Body-colour door handles, front and rear bumpers	●
Black painted door mirrors	●
Integrated tailgate spoiler	●
Black Griffin logo, vizer frame, rear lettering and skid plates	●
Dark-tinted rear side and tailgate windows	●
Silver-effect roof rails	●
Roof and window moulding colours	
Body-coloured roof	No-cost
Black roof	●
Chrome-effect upper window moulding	●



Body-coloured roof.



Black roof and silver-effect roof rails.



Dark-tinted windows and chrome-effect window moulding.

Exterior colours

Arctic White (POWP)*
Brilliant paint



VX_CRO_34176.psd

Crystal Silver (MOZR)**
Two-coat metallic paint **£600**



VX_CRO_34181.psd

Carbon Black (M09V)**
Two-coat metallic paint **£600**



VX_CRO_34178.psd

Crimson Red (MOPQ)**
Two-coat premium metallic paint **£700**



VX_CRO_34179.psd

The colours reproduced may vary slightly from the actual paint colour. As a result they should be used as a guide only. Your Vauxhall Retailer has a comprehensive display of our paint samples.

Please note, vehicles illustrated are not model specific and are for illustrative purposes only.

*Standard exterior paint. **Optional at extra cost including VAT.

PureEnergy – Petrol

Petrol engines	1.2 (110PS) Turbo with 6-speed manual	1.2 (130PS) Turbo with 6-speed automatic
Capacity	1199cc	1199cc
Maximum power	110PS (81kW) @ 5500rpm	130PS (96kW) @ 5500rpm
Maximum torque	205Nm (151lb.ft.) @ 1750rpm	230Nm (169lb.ft.) @1750rpm
Configuration	3 cylinders, 4 valves per cylinder, double overhead camshafts	3 cylinders, 4 valves per cylinder, double overhead camshafts
Fuel/induction system	Turbocharger. Variable Valve Timing. Direct fuel injection	Turbocharger with intercooler. Multi-point sequential fuel injection
Emission compliance	Euro 6.4	Euro 6.4
Service interval	12,500 miles or 1 year (whichever occurs sooner)	12,500 miles or 1 year (whichever occurs sooner)

Performance, fuel economy and emissions	Performance (manufacturer's figures)		Fuel economy mpg (litres/100km) [#]		CO ₂ emissions g/km [#]		Vehicle Excise Duty*		BiK rates from – 2023/24 tax year
	Maximum speed (mph)	Acceleration 0 – 60mph (sec)	Combined Low	Combined High	Combined Low	Combined High	First year rate	Standard rate	
1.2 (110PS) Turbo	116	10.5	47.9 (5.9)	48.7 (5.8)	131	134	£270	£190	31%
1.2 (130PS) Turbo auto	123	9.9	44.1 (6.4)	44.8 (6.3)	141	144	£270	£190	33%

[#]Figures shown are for comparison purposes and should only be compared to the fuel consumption and CO₂ values of other cars tested to the same technical standard. The fuel consumption achieved, and CO₂ produced, in real world conditions will depend upon a number of factors including, but not limited to: the accessories fitted (pre and post registration); variations in weather; driving styles and vehicle load. The WLTP (Worldwide Harmonised Light Vehicles Test Procedure) is used to measure fuel consumption and CO₂ figures. The CO₂ figures display a range to reflect the highest value for the highest emitting version with all available options added, through to a minimum value to represent the lowest emitting version in standard specification.

*Correct at time of publication.

Specifications

Transmissions

Six-speed manual gearbox

Petrol engines: 1.2 (110PS) Turbo models

Six-speed automatic transmission

Petrol engines: 1.2 (130PS) Turbo models

Steering

- Speed-sensitive electric power-assisted steering
- Turning circle (wall-to-wall): 11.21m (36.7ft)

Suspension

- Front: Independent. Lightweight MacPherson struts with gas-pressure dampers and coil springs. Anti-roll bar
- Rear: Compound crank with coil springs and hydraulic dampers

Braking and stability

- Switchable Electronic Stability Programme (ESP)
 - Anti-lock Braking System (ABS)
 - Corner stability control
 - Traction control
 - Hill start assist
 - Engine drag torque control
 - Hydraulic brake assist
 - Hydraulic brake boost
 - Electronic brakeforce distribution
- 1.2 (110PS) Turbo/1.2 (130PS) Turbo**
- Front ventilated discs: 283mm diameter
 - Rear discs: 249mm diameter

Fuel tank capacity

- 45 litres (9.9 gallons)

Body

- Aerodynamic drag co-efficient: Cd 0.31

Exterior dimensions – mm (inches)		
Length	4212 (165.8)	
Width (with mirrors)	1976 (77.8)	
Height	1605 (63.2)	
Wheelbase	2604 (102.5)	
Loadspace dimensions – mm (inches)		
Maximum length behind rear seats	793 (31.2)	
Maximum length rear seats folded	1483 (58.4)	
Maximum width	1000 (39.4)	
Maximum height	894 (35.2)	
Luggage capacities – Litres (cu.ft.)		
Rear seats up (under luggage compartment cover)	410 (14.5)	
Rear seats up with optional sliding rear seats in forward-most position	520 (184)	
Rear seats folded (to roof)	1255 (44.3)	
Weights and towing data – kg		Maximum towing weights. Trailer with brakes (without brakes)
1.2 (110PS) Turbo	Gross vehicle weight	1770
1.2 (130PS) Turbo auto		1835
		840 (600)
		840 (600)

Please note: Gross vehicle weight is the total permissible weight of the vehicle including passengers and their luggage. The maximum roof rack loading should not exceed 70kg. The maximum towing weights are based on the ability of the car, with two occupants of 75kg each, to restart on a 12% gradient, which is approximately 1 in 8.3, at sea level. The permitted trailer load applies up to the specified incline and up to an altitude of 1000 metres above sea level. The permissible gross train weight decreases by 10% for every 1000 metres of additional altitude. At altitudes above 1500 metres, the engine output may drop with a corresponding reduction in towing capability. Any extra weight, such as luggage or additional passengers, should be deducted from the maximum towing weight. With a trailer fully loaded, maximum noseweight should not exceed 55kg. Always fit Vauxhall towing attachments and accessories available from your Vauxhall Retailer. They are designed specifically for Vauxhall models and carry a 12-month guarantee. During trailer towing do not exceed a maximum speed of 60mph. This speed limit is also applicable in countries with higher permitted speeds for trailer-vehicle combinations. Pay attention to the local speed limits. For trailers with low driving stability and caravans the use of an oscillation damper is strongly recommended.

Company car driver and fleet information

Benefit in kind company car taxation*

The car benefit charge will be the car's list price (including VAT, options and accessories fitted, delivery to Retailer and number plates, but excluding Vehicle Excise Duty and new vehicle first registration fee) multiplied by the percentage charge for the CO₂ emissions band in which the car falls (see table opposite). Multiply this figure by your personal income tax rate (20%** for Basic Rate, 40%** for Higher Rate) to calculate your annual benefit in kind tax liability.

Generic example:

PETROL vehicle: 129g/km CO₂

On-the-road RRP	£20,260.00
Deduct: Vehicle Excise Duty	-£190.00
New vehicle first registration fee	-£55.00
Effective list price	£20,015.00
Add: Optional two-coat metallic paint	£600.00
List price for tax purposes (P11D value)	£20,615.00
Car benefit charge 2023 – 24 tax year (30%)	£6,184.50
Benefit in kind tax liability	
Basic Rate (20%) tax payer	£1,237.00
Higher Rate (40%) tax payer	£2,474.00

*Please note this Price Guide provides taxation information as a guide only. Vauxhall does not provide taxation guidance. Drivers should always take professional advice on their own tax position.
 **Excludes residents of Scotland.

BiK for Scottish Residents

Effective 6 April 2018 the Scottish Government have introduced their own BiK taxation structure. This only applies to Company Car Drivers that are Scottish taxpayers. HMRC will determine whether or not an individual is a Scottish taxpayer based on where their main place of residence is.

The BiK rates for Scotland are:

- Over £12,570 – £14,732 Starter Rate 19%
- Over £14,732 – £25,688 Basic Rate 20%
- Over £25,688 – £43,662 Intermediate Rate 21%
- Over £43,662 – £150,000 Higher Rate 41%
- Above £150,000 Top Rate 46%

To calculate your own personal liability, click the link [Vauxhall BiK Tool](#)

CO ₂ (g/km)	Electric range (miles)	% 2024 – 25 tax year
0	-	2%
1 – 50	130+	2%
1 – 50	70 – 129	5%
1 – 50	40 – 69	8%
1 – 50	30 – 39	12%
1 – 50	<30	14%
51 – 54	-	15%
55 – 59	-	16%
60 – 64	-	17%
65 – 69	-	18%
70 – 74	-	19%
75 – 79	-	20%
80 – 84	-	21%
85 – 89	-	22%
90 – 94	-	23%
95 – 99	-	24%
100 – 104	-	25%
105 – 109	-	26%
110 – 114	-	27%
115 – 119	-	28%
120 – 124	-	29%
125 – 129	-	30%
130 – 134	-	31%
135 – 139	-	32%
140 – 144	-	33%
145 – 149	-	34%
150 – 154	-	35%
155 – 159	-	36%
160+	-	37%

Vehicle Excise Duty†

The amount of Vehicle Excise Duty (road fund licence) payable on new cars varies depending on the level of carbon dioxide (CO₂) emissions produced by the vehicle. CO₂ emissions are measured in grams per kilometre (g/km) travelled and divided into 13 charging bands shown in the table below.

A 'first year rate' of Vehicle Excise Duty is payable on all new cars and in subsequent years the amount payable reverts to a different rate. Also, for vehicles with a list price over £40,000, including factory-fitted options, an additional £410 is payable for five years after registration.

VED Band	CO ₂ (g/km)	First year rate Petrol/ Diesel	First year rate Hybrid/ Electric
A	0	£0	£0
B	1 – 50	£10	£0
C	51 – 75	£30	£20
D	76 – 90	£135	£125
E	91 – 100	£175	£165
F	101 – 110	£195	£185
G	111 – 130	£220	£210
H	131 – 150	£270	£260
I	151 – 170	£680	£670
J	171 – 190	£1,095	£1,085
K	191 – 225	£1,650	£1,640
L	226 – 255	£2,340	£2,330
M	Over 255	£2,745	£2,735

†Correct at time of issue.

Fleet Toolbox

The Fleet Toolbox has a host of useful calculators, comparators, interactive listings and information.

Click the link for more information

[Vauxhall Fleet Tool Box](#)

Contact Vauxhall Fleet

Please contact one of our dedicated sales teams who will be happy to help with your particular enquiry.

Fleet Decision Makers

Depending on the size of your fleet of vehicles, we have a dedicated team to handle your enquiries. The lines are open Monday to Friday excluding Bank Holidays.

1 – 24 vehicles

Call: 0203 885 4560 (8:30am – 5:00pm)

Email: enquiries@stellantis-fleet.co.uk

50+ vehicles

Call: 0203 885 4562 (8:30am – 5:00pm)

Email: enquiries@vauxhallfleet.co.uk

Special Vehicles (Police, Fire and Ambulance)

Call: 01582 409999

Email: psvo@stellantis.com

For more information visit vauxhall.co.uk/fleet

Further information

On-the-road prices

To eliminate uncertainty about hidden costs when buying a new car, Vauxhall publishes on-the-road recommended retail prices (RRP) and these are shown in the pricing tables within this price guide. These prices include VAT, number plates and delivery to Retailer of £900.00 (including £150.00 VAT), 12 months' Government Vehicle Excise Duty and the DVLA new vehicle first registration fee of £55.00.*

Please note: The on-the-road recommended retail price (RRP) does not include fuel supplied by the Retailer, motor insurance or any other goods or services supplied by agreement between the Retailer and the customer.

Price protection

Order a new Vauxhall for build in the current model year (as confirmed by your Retailer) for delivery no more than three months in advance and the price you are quoted is the price you pay. This is irrespective of any subsequent price rises between placing your order and delivery of your new car, but you must take delivery as soon as the car is available. Please note: Vauxhall Motors Limited is not liable for price adjustments caused by Government changes in the rate of VAT (currently 20%), Vehicle Excise Duty, DVLA new vehicle first registration fee or by any other applicable legislation or regulations.

Customer Care Commitment

For added peace of mind, Vauxhall has an innovative Customer Care Commitment that offers the following:

- Three-year vehicle warranty consisting of a one year/unlimited mileage manufacturer's warranty and a second and third year manufacturer's warranty with a 60,000 miles limitation

- Vauxhall Assistance for 12 months from first registration
- Six years' body panel anti-perforation warranty

Please note: Warranty is only available on vehicles sourced from Vauxhall Motors Limited. Terms and conditions apply – please see your Vauxhall Retailer for details.

Vauxhall Assistance

Vauxhall Assistance is provided automatically with every new Vauxhall for 12 months from first registration and covers everything from accident assistance, roadside recovery and 'at home' service to flat tyres. For even more peace of mind, on fully electric models, the cover is extended** to 3 years. Even more reason for you to stay calm and let us take care of everything should the need arise. With Vauxhall Assistance help is literally just a free† phone call away, 24 hours a day, 365 days a year!

LEASYS

Leasys UK

Leasys is the proud Business Contract Hire partner of Vauxhall and consequently, can provide quick vehicle delivery to keep your business mobile. Specialised in Medium to Long-Term Leasing options and Fleet Management solutions for businesses of all sizes, [Leasys](#) lead mobility by offering sustainable and innovative solutions designed around customers, for a best-in-class experience. Their team of experts can personally support you and provide dedicated consultation. [Leasys](#) is equally owned by Stellantis and Crédit Agricole Consumer Finance and is a member of the British Vehicle Rental and Leasing Association (BVRLA). For further information, please contact your local Vauxhall Retailer or visit [leasys.com/uk](#)

In the event of an accident

Vauxhall Accident Management helps keep you mobile following an accident. Benefits include vehicle recovery, Vauxhall-approved repairs and contacting your insurer. For more details, visit [vauxhall.co.uk/AccidentManagement](#)

Vauxhall Flexcare – Service Plans and Extended Warranty

Designed for your peace of mind. A collection of extended warranty and service plans to match the way you drive.

Extended Warranty

An extended warranty for your Vauxhall offers you similar cover for material or manufacturing defects beyond the original warranty period on the vehicle. By choosing an official Vauxhall Extended Warranty, we guarantee that any repairs you need are carried out by Vauxhall trained technicians using genuine Vauxhall parts.

Service Plans

There's no need to worry about budgeting for your next service. Simply take out a Vauxhall Fixed Price Service Care Plan. You can then focus on the more important things in life, knowing your servicing costs are taken care of. For more information, click on the link below or call us on **0345 600 2065**. See [vauxhall.co.uk/discover/here-for-you.html](#)

Vauxhall Service Club

A world of servicing, repair and accessory benefits with Vauxhall Service Club is available for all Vauxhall owners, and it's free to join via the MyVauxhall app (terms and conditions apply). For a list of benefits and details on how to join visit: [vauxhall.co.uk/serviceclub](#)

Vauxhall Insurance with added reassurance

Join the family or find out more about Vauxhall Insurance Services by contacting our insurance team on **0330 678 1130**††, or visit: [vauxhall.co.uk/offers-finance/insurance.html](#)

Vauxhall Accessories

From the small things that make life easier to the big things that make life exciting – personalise your Vauxhall with Vauxhall Accessories. So what are you looking for? A device holder, roof box, or even splash guards? Whatever it is we've got the solution for you. With our huge accessory range, all tailor-made for your Vauxhall and come with a full year's warranty. For further details visit your local Retailer or see [vauxhall.co.uk/owners/accessories.html](#)

Protecting the environment

Vauxhall's commitment to the environment is demonstrated by our products' many environmental awards. For even more information on Vauxhall's efforts to achieve an environmentally sustainable future, and how to dispose of your end-of-life vehicle, see [vauxhall.co.uk/recycling](#)

For more product information

For further information on the Vauxhall range or location of your nearest Vauxhall Retailer please call **0800 026 0034**. Alternatively, details can be found on our website at [vauxhall.co.uk](#)

VAUXHALL

For more information call **0800 026 0034**

For Fleet enquiries call **0203 476 2268**

Discover the full Vauxhall range at **[vauxhall.co.uk](https://www.vauxhall.co.uk)**

Join us online

The invoice price, including delivery to Retailer, factory-fitted options, accessories fitted by the Retailer and number plates, is subject to VAT. Some feature descriptions in this guide may refer to, and some illustrations may show, optional equipment not included in the standard delivery. The information contained in this guide was accurate at the time of publication. We reserve the right to make changes in design and equipment. Please note that Vauxhall Retailers are not the agents of Vauxhall Motors Limited and are not authorised to bind Vauxhall Motors Limited by any specific or implied undertaking or representation. It is advisable to ensure that your motor insurance policy provides adequate cover for additional fitted options and accessories. The colours in this guide are only approximate actual colours. Illustrated optional equipment is available at extra charge. Availability, technical features and equipment provided on our vehicles can vary by model. For precise information on the equipment provided on our vehicles, please contact your local Vauxhall Retailer.

Price and Specification Guide
16 May 2024 | Model Year 2024C



Grandland

Contents

To find the information you want use the links below to navigate around the guide:

Models

Prices

Vauxhall PureSense

Vauxhall PureConnect

Comfort and convenience

Safety and security

Styling

Exterior colours

Vauxhall PureEnergy

Specifications

Company car information

Further information

At Vauxhall, we believe great cars are for everyone.

We believe technology works best when it's not just smart but is also simple and intuitive. Where everyone can feel the instant excitement of electric; can keep themselves and their loved ones safer on the road; and can stay connected to the things that matter most, simply and easily. We call it Vauxhall Pure Technology. No gimmicks, nothing complicated, just technology that makes driving better, easier and more exciting, for everyone.

Our latest Grandland Price and Spec guide outlines the Pure Technology features model by model. Together with all the essential information you need to compare Prices, Technical Information and Specification plus details of our commitment to offer the best in Customer Care.

We're delighted you're considering the purchase of a new Grandland and hope this guide will help you make the right choice.



Ultimate



Grandland Ultimate JO.tiff

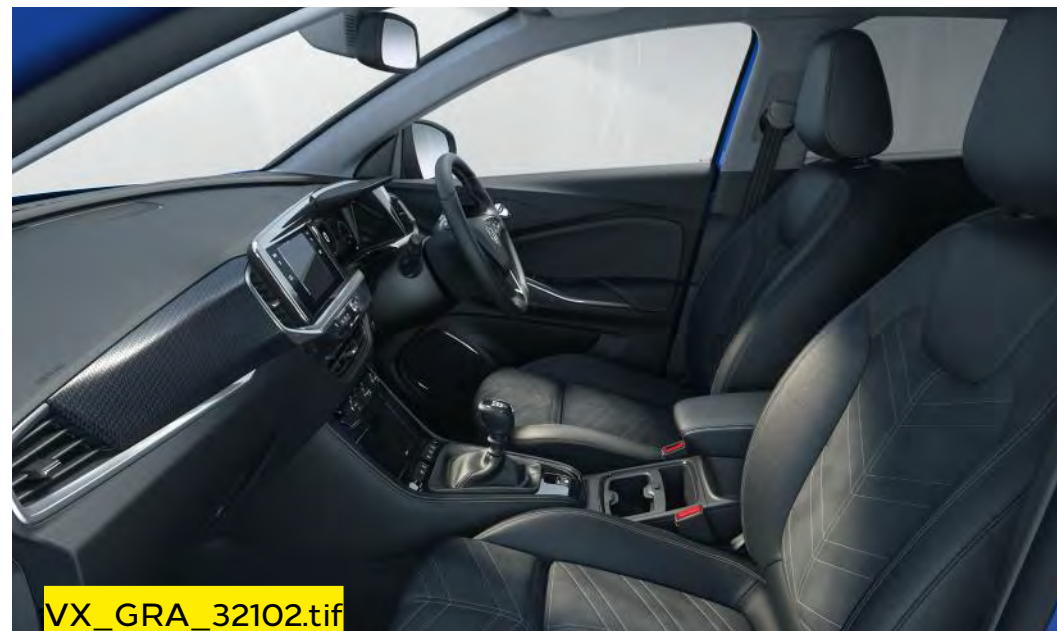

VX_GRA_32102.tif



19-inch alloy wheel.

Features:

PureSense

- IntelliLux adaptive LED® pixel headlights
- LED front fog lights
- 360° panoramic parking camera
- Highway integration assist (auto only)
 - Lane positioning assist
 - Adaptive cruise control
- LED headlights, tail lights and daytime running lights
- High beam assist
- Automatic lighting control
- Electronic parking brake
- Lane departure warning with lane keep assist
- Speed sign recognition
- Driver drowsiness alert
- Automatic emergency braking
- Six airbags
- Cruise control with speed limiter
- Hill start assist
- ISOFIX child seat fixings on front passenger seat and outer rear seats
- Front and rear parking distance sensors
- Side blind spot alert

Comfort and convenience

- Storage pocket on front seat backs
- Power operated tailgate with foot sensor
- Keyless entry and start
- Load-through facility in the rear
- Heated windscreen
- Dual-zone electronic climate control
- Flat-bottomed leather-effect steering wheel
- Steering wheel audio/phone/cruise controls
- 60/40 split-folding rear seat backs
- Rain-sensitive windscreen wipers
- Electrically operated front and rear windows
- Electrically adjustable/heated door mirrors
- Soundproofed insulated windscreen
- Driver's armrest
- Remote control security alarm system
- Heated steering wheel
- Automatic anti-dazzle rear-view mirror
- Centre rear seat armrest
- Electrically foldable door mirrors

PureConnect

- Multimedia Pure Panel Navigation system
 - 10-inch colour touchscreen
 - 12-inch digital instrument cluster
 - Satellite Navigation
 - AM/FM/DAB digital radio
 - Bluetooth®
 - Apple CarPlay/Android Auto™
 - Front USB connection
- Six speakers
- Vauxhall Connect
- Wireless charger for mobile devices

Interior

- Black Alcantara seat trim inserts
- Ergonomic active heated sports-style front seats (AGR-approved*) – six-way adjustable:
 - Seat cushion extension
 - Lumbar adjustment
- Focus black fabric seat trim inserts
- Black premium leather-effect side bolsters
- Dax décor facia panel with palladium medium finish
- Black door panels with black premium leather-effect inserts

Styling

- 19-inch bi-colour diamond-cut alloy wheels
- Black roof with high gloss black roof rails
- High gloss black exterior detailing
- Dark-tinted rear windows

Prices

Petrol	LCDV code	Price (£)	VAT (£)	Total (£)	On-the-road RRP (£)	Financial year 2024/25 BiK 20% (£)	WLTP combined CO ₂ (g/km) [#] - LCDV code	Insurance groups
Ultimate								
1.2 (130PS) Turbo	1GUOSYKM6KT040JO	28,475.00	5,695.00	34,170.00	35,395.00	192.89	140	17E
1.2 (130PS) Turbo auto	1GUOSYKM61T040JO	29,850.00	5,970.00	35,820.00	37,045.00	208.08	147	17E
1.2 (136PS) Turbo Hybrid e-DCT6 auto	1GUOSYKJHWT040JO	30,975.00	6,195.00	37,170.00	38,335.00	190.35	127	20E

Grandland's petrol engines meet the Real Driving Emissions Step 2 (RDE2) standards.

WLTP combined CO₂ (g/km) figures are based on a configured vehicle as per LCDV code for UK with no options fitted.

[#]Provisional fuel consumption and CO₂ figures are determined according to the WLTP test cycle. CO₂ figures, BiK values and RRP pricing shown above are for a standard vehicle without any additional optional equipment. CO₂ figures are used to calculate Vehicle Excise Duty (VED) for the first registration of the vehicle and BiK. The addition of optional extras could increase the certified CO₂ emission output. This in turn may affect the amount of VED payable upon registration, and, for company car drivers, the P11D value and the amount of Benefit in Kind (BiK) tax payable. Figures shown are for comparison purposes and should only be compared to the fuel consumption and CO₂ values of other cars tested to the same technical standard. The fuel consumption achieved, and CO₂ produced, in real world conditions will depend upon a number of factors including, but not limited to: the accessories fitted (pre and post registration); variations in weather; driving styles and vehicle load. The WLTP (Worldwide Harmonised Light Vehicles Test Procedure) is used to measure fuel consumption and CO₂ figures. Full data relating to WLTP test cycles can be found at: www.vauxhall.co.uk/wltp

Please note: On-the-road recommended retail prices (RRP) include number plates and delivery to Retailer of £900.00 (including £150.00 VAT), 12 months' Vehicle Excise Duty and new vehicle first registration fee of £55.00. Excludes fuel and insurance. Company Car Benefit in Kind (BiK) rates are monthly based on the standard paint price.

PureSense

Model specific features/option	Ultimate
Driver assistance	
Cruise control with speed limiter	●
Lane departure warning with lane keep assist	●
Speed sign recognition	●
Driver drowsiness alert	●
Hill-start assist	●
Automatic emergency braking with pedestrian detection	●
Front and rear parking distance sensors	●
360° panoramic parking camera	●
Advanced park assist	●
Side blind spot alert	●
Highway integration assist – Lane positioning assist/ Adaptive cruise control	auto only
Forward collision alert	auto only
Exterior lighting	
LED headlights, tail lights and daytime running lights	●
Automatic lighting control	●
High beam assist	●
IntelliLux adaptive LED® pixel headlights	●
LED front fog lights	●

Please note, Vauxhall driver assistance systems are intended to support the driver within the system-imminent limitations. The driver remains responsible for the driving task at all times.

*Optional at extra cost including VAT.

PureConnect

Pure Panel digital display

Pure Panel technology makes driving more intuitive, with a flowing design that presents the information you need. With up to 10-inch infotainment touchscreen and 12-inch digital instrument cluster right in front of you, you can stay focused on the road ahead.

EV information display

- Powerflow display – Informs drivers on the current state of charge and what is being used as the power source, petrol or electric
- Charge display – displays an image of the charge port with the corresponding LED charge indication lights
- e-Save – enables the driver to determine how much battery energy needs to be conserved to ensure that the vehicle reaches its destination when in a zero emission zone
There are three options:
 - 6 mile range reserve
 - 12 mile range reserve
 - Maximum reserve
- Statistics – The Statistics display the average consumption data over a period of time using colour coded graphs
- **Green:** Energy recovered by braking phases and partial recharging by the petrol engine (kWh/mile)
- **Blue:** Energy consumed by the vehicle directly by the battery (kWh/mile)
- **Orange:** Fuel consumption (mpg)

Digital instrumentation

- Digital speedometer and rev counter
- Satellite Navigation display
- Digital fuel gauge with low fuel level warning light
- Digital water temperature gauge with warning light
- Shift-up/down indication light – Indicates when to change gear for optimum fuel economy

Multimedia

Features

- 7-inch colour touchscreen
- DAB Digital radio
- RDS with Traffic Programme
- AM/FM stereo radio with 25 station presets

Media connections

- USB connection
- Bluetooth® A2DP audio streaming (Advanced Audio Distribution Profile)
- Six speakers

Mobile phone portal

- Bluetooth® connectivity
- Handsfree calls via steering wheel controls
- Vehicle microphone
- Phone book access – contacts/last calls/missed calls etc. are mirrored on IntelliLink's display and are easily navigated using the touchscreen (features dependent on mobile phone)

Smartphone interface

- Apple CarPlay
- Android Auto™
- Smartphone projection that allows operations via voice command, touchscreen and buttons to control apps and music playback

Additional features

- Steering wheel mounted audio controls
- Flexible roof-mounted aerial

Multimedia Navi Pro – Ultimate

Features over Multimedia

- 10-inch colour touchscreen
- Satellite navigation system
- 2D/3D street level mapping
- European coverage
- Points-of-interest search
- Map updates via USB

Additional features

- Shark fin aerial

Driver information

Driver information display

(centrally located in instrument cluster)

- Total mileage
- Service-due indicator
- Oil life
- Tyre pressure monitoring system

Multi-function trip computer

(displayed on digital instrument cluster)

- Trip mileage
- Vehicle range based on remaining fuel
- Average speed
- Average fuel economy
- Instantaneous fuel economy
- Driving time

Digital central facia display

(format dependent on infotainment unit)

- Audio information
- Digital clock with automatic RDS time adjustment
- Outside air temperature with ice warning function

Model specific features	Ultimate
Driver information	
12-inch digital instrument cluster (centrally located in instrument panel)	●

Vauxhall Connect



Safety

The more you know, the safer your journey – that's why our smart tech and connected services keep you constantly updated on what's going on inside and outside your vehicle.

Peace of mind

- Emergency call (SOS e-call)
- Breakdown call (b-call)

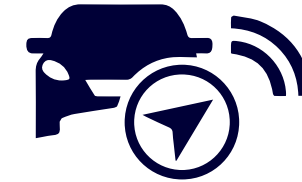

Live navigation plus†

With real-time directions and traffic information from the leading European GPS provider, TomTom®, every journey will be a breeze.

- TomTom® services
- Real time traffic news
- Parking prices and availability
- Weather forecast on your journey
- Natural voice control
- Fuel prices at petrol stations
- Search for charging stations
- Quick search for points of interest
- Road safety alerts



Maintenance

Connected services are here for you – even when things go wrong. Our Intelligent Telemaintenance service monitors the key functions of your vehicle – and notifies you as soon as something needs attention.

- Vehicle status and information**
- Maintenance alerts, fuel level, average fuel consumption and mileage

Vauxhall Connect* is the smart way to stay connected while on the road. Innovative technology systems and related services keep our drivers safe and provide an exciting, efficient yet safe trip.

Download
MyVauxhall now!



Explore MyVauxhall

Ready to make life easier? Meet MyVauxhall – your one-stop shop for everything Vauxhall. Plan journeys from the comfort of your armchair. View your next scheduled service, book a vehicle repair, access your handbook and much more!

Also if you drive an electric vehicle or plug-in hybrid, you'll love our e-Remote Control app feature. Use it to pre-condition your cabin temperature before journeys – and maximise your charge. Or pre-schedule charging times at night, and benefit from cheaper electricity.



Phone_MyVauxhall_mockup_Car.psd

For more information visit vauxhall.co.uk/discover/myvauxhall.html

†Additional terms and conditions apply to connected services, including customer acceptance of location sharing prior to activation.

Comfort and convenience

Model specific features/option	Ultimate
Interior convenience	
Front 12-volt electrical accessory socket	●
60/40 split-folding rear seat backs	●
Reach and rake-adjustable steering	●
Steering wheel mounted audio/phone/cruise controls	●
Electronic parking brake	●
Electrically operated front and rear windows	●
Electrically adjustable/heated power folding door mirrors	●
Soundproofed insulated windscreen	●
Driver's and front passenger's sunvisors with illuminated vanity mirrors	●
Automatic dimming anti-dazzle rear-view mirror	●
Frameless automatic anti-dazzle rear-view mirror with LED spotlight	
Centre rear seat armrest with load-through facility	●
Wireless charger for mobile devices	●
Storage pocket on front seat backs	●
Keyless entry and start	●
Luggage restraining net	£35*

Comfort and convenience

Model specific features	Ultimate
Heating and ventilation	
Dual-zone electronic climate control	●
Heated front seats	●
Heated steering wheel	●
Partial heated windscreen	
Heated windscreen	●
Thermal pre-conditioning – allows interior temperature to be optimised prior to departure maximising electric-only range	
Interior lighting	
Rear reading lights	●
Illuminated luggage area	●
Ambient centre console downlighter	●
Exterior convenience	
High gloss black roof rails	●
Power operated tailgate with foot sensor	●
Wipers	
Two-speed windscreen wipers with variable intermittent wipe	●
Intermittent rear window wash/wipe	●
Rain-sensitive windscreen wipers	●
Magic wash system – Using nozzles located above the wiper blades, fluid is distributed as the wiper sweeps the windscreen. This avoids the ‘temporary blindness’ of more conventional bonnet mounted systems between fluid release and wiper sweeping, improving visibility	●

Safety and security

Model specific features/option	Ultimate
Airbags	
Driver's and front passenger's airbag/Front seat side-impact airbags/ Full-size curtain airbags	●
Tyre pressure	
Tyre pressure monitoring system	●
Safety	
Deactivation switch for front passenger's front and side-impact airbags	●
ISOFIX compatible child seat mountings located on front passenger's seat and outer rear seats (does not include child seat)	●
Child-proof locks on rear doors	●
Provision for spare wheel fitment – spare wheel is Retailer-fit, deletes emergency tyre inflation kit	£20*
Security	
Central locking	●
Remote control security alarm system	●

*Optional at extra cost including VAT.

Styling

Model specific features	Ultimate
Exterior styling	
Black door mirrors and side window trim	●
Body-colour door handles	●
Rear spoiler	●
Black roof (not available with Carbon Black)	●
Dark-tinted rear windows	●
Body-colour upper front bumper	●
High-gloss black protective front and rear skid plates and C-shape bumper inserts	●
Carbon black lower front and rear bumpers, protective wheel arches, and lower door cladding	●
Silver-effect protective front and rear skid plates	●
High-gloss black Griffin for Vizor grille and tailgate with high-gloss black Grandland tailgate lettering	●

Exterior colours

Arctic White (OMPO/ONWP)*
Brilliant paint



VX_GRA_33128.psd

Contrast Grey (OMMO/ONF4)**
Two-coat metallic paint £600



VX_GRA_33131.psd

Carbon Black (OMMO/ON9V)**
Two-coat metallic paint £600



VX_GRA_33132.psd

Carmin Red (OMMO/ONLM)**
Two-coat premium metallic paint £700



VX_GRA_33130.psd

Black roof



Grey_black_roof.tif

The colours reproduced may vary slightly from the actual paint colour. As a result they should be used as a guide only. Your Vauxhall Retailer has a comprehensive display of our paint samples.

Please note, vehicles illustrated are not model specific and are for illustrative purposes only.

*Standard exterior paint. **Optional at extra cost including VAT.

PureEnergy – Petrol

Petrol engine	1.2 (130PS) Turbo	1.2 (136PS) Turbo Hybrid e-DCT6 auto
Capacity	1199cc	1199cc
Maximum power	130PS (96kW) @ 5500rpm	136PS (100kW) @ 5500rpm
Maximum torque	230Nm (169lb.ft.) @ 1750rpm	230Nm (169lb.ft.) @ 1750rpm
Configuration	3 cylinders, 4 valves per cylinder, double overhead camshafts	3 cylinders, 4 valves per cylinder, double overhead camshafts
Fuel/induction system	Turbocharger. Variable Valve Timing. Common rail direct injection	Turbocharger. Variable Valve Timing. Common rail direct injection
Emission compliance	Euro 6d (6.4)	Euro 6d (6.4)
Service interval	16,000 miles or 1 year (whichever occurs sooner)	zz16,000 miles or 1 year (whichever occurs sooner)

Performance, fuel economy and emissions	Performance (manufacturer's figures)		Fuel economy mpg (litres/100km)#		CO ₂ emissions g/km#		Vehicle Excise Duty*		BiK rates from – 2023/24 tax year
	Maximum speed (mph)	Acceleration 0 – 60mph (sec)	Combined Low	Combined High	Combined Low	Combined High	First year rate	Standard rate	
1.2 (130PS) Turbo	122	10.4	45.6 (6.2)	46.3 (6.1)	137	140	£260	£190	32%
1.2 (130PS) Turbo auto	121	10.3	43.4 (6.5)	44.1 (6.4)	144	147	£260	£190	33%
1.2 (136PS) Turbo Hybrid e-DCT6 auto	121	10.0	50.4 (5.6)	51.3 (5.5)	124	127	£210	£190	30%

#Figures shown are for comparison purposes and should only be compared to the fuel consumption and CO₂ values of other cars tested to the same technical standard. The fuel consumption achieved, and CO₂ produced, in real world conditions will depend upon a number of factors including, but not limited to: the accessories fitted (pre and post registration); variations in weather; driving styles and vehicle load. The WLTP (Worldwide Harmonised Light Vehicles Test Procedure) is used to measure fuel consumption and CO₂ figures. The CO₂ figures display a range to reflect the highest value for the highest emitting version with all available options added, through to a minimum value to represent the lowest emitting version in standard specification.

*Correct at time of publication.

Specifications

Transmissions

Six-speed manual gearbox

Standard on all models.

Eight-speed automatic transmission

Available at extra cost on all models.

The 8-speed automatic gearbox available for the Grandland offers smooth transitions between gears. The 8-speed automatic gearbox includes the following features:

- Optimised internal frictions to improve efficiency
- Optimised torque convertor to improve gear shift smoothness and reduce idling vibrations
- Quickshift technology that offers one of the fastest shifting on the market
- Manual shifting mode available with shift paddles

Drive mode selector (auto-only)

The driver can determine the driving style by selecting one of the following modes:

- **Normal:** for a balanced drive that offers a compromise between performance and energy efficiency
- **Sport:** for a dynamic drive with a responsive throttle and the highest top speed and torque
- **ECO:** for maximum range and energy efficiency. The ECO mode deactivates all unnecessary energy-consuming features and reduces the top speed, torque and overall performance

Hybrid e-DCT6 auto

1.2-litre petrol engine paired with a new six-speed dual clutch automatic transmission and a 28hp electric motor.

Permanent magnet synchronous electric motor is integrated into the gearbox and produces peak power of 21kW (28hp) and maximum torque of 55Nm.

During deceleration from higher constant speeds, the petrol engine stops and the e-motor acts as a generator to recharge the hybrid system's 48v battery.

Under low torque requirements the e-motor allows short distances to be driven on electric power alone (e.g. when manoeuvring or under 18mph in city traffic). It also assists the petrol engine under acceleration, such as when driving from standstill.

Steering

- Speed-sensitive electric power-assisted steering

Fuel tank capacities

- 53 litres – Petrol
- 52.5 litres – Hybrid

Suspension

- Front: Independent. Decoupled MacPherson struts with gas-pressure dampers and coil springs. Anti-roll bar
- Rear: Compound crank with coil springs and gas-pressure dampers

Exterior dimensions – mm (inches)	Petrol
Length	4477 (176.3)
Width (with mirrors)	2098 (82.6)
Height (including roof rails)	1609 (63.3)
Wheelbase	2675 (105.3)
Loadspace dimensions – mm (inches)	Petrol
Maximum length (behind rear seats)	873 (34.4)
Maximum length (rear seats folded)	1696 (66.8)
Maximum width	1053 (41.5)
Maximum height	987 (38.8)
Luggage capacities* – Litres (cu.ft.)	Petrol
Rear seats up (under luggage compartment cover)	514 (18.1)
Rear seats folded (to roof)	1652 (58.3)
Weights and towing data – kg	Gross vehicle weight
1.2 (130PS) Turbo	1930
1.2 (130PS) Turbo auto	1955
1.2 (136PS) Turbo Hybrid e-DCT6 auto	2050

Please note: Gross vehicle weight is the total permissible weight of the vehicle including passengers and their luggage. The **maximum roof rack loading** should not exceed 70kg. The **maximum towing weights** are based on the ability of the car, with two occupants of 75kg each, to restart on a 12% gradient, which is approximately 1 in 8.3, at sea level. The permitted trailer load applies up to the specified incline and up to an altitude of 1000 metres above sea level. The permissible gross train weight decreases by 10% for every 1000 metres of additional altitude. At altitudes above 1500 metres, the engine output may drop with a corresponding reduction in towing capability. Any extra weight, such as luggage or additional passengers, should be deducted from the maximum towing weight. With a trailer fully loaded, **maximum noseweight** should not exceed 55kg. Always fit Vauxhall towing attachments and accessories available from your Vauxhall Retailer. They are designed specifically for Vauxhall models and carry a 12-month guarantee. During trailer towing do not exceed a maximum speed of 60mph. This speed limit is also applicable in countries with higher permitted speeds for trailer-vehicle combinations. Pay attention to the local speed limits. For trailers with low driving stability and caravans the use of an oscillation damper is strongly recommended.

*Measured using the ECIE method.

Company car driver and fleet information

Benefit in kind company car taxation*

The car benefit charge will be the car's list price (including VAT, options and accessories fitted, delivery to Retailer and number plates, but excluding Vehicle Excise Duty and new vehicle first registration fee) multiplied by the percentage charge for the CO₂ emissions band in which the car falls (see table opposite). Multiply this figure by your personal income tax rate (20%** for Basic Rate, 40%** for Higher Rate) to calculate your annual benefit in kind tax liability.

Generic example:

HYBRID vehicle: 27g/km CO₂, up to 41 miles (electric-only range)

On-the-road RRP	£40,955.00
Deduct: Vehicle Excise Duty	-£10.00
New vehicle first registration fee	-£55.00
Effective list price	£40,900.00
Add: Optional two-coat metallic paint	£600.00
List price for tax purposes (P11D value)	£41,500.00
Car benefit charge 2023 – 24 tax year (14%)	£5,810.00
Benefit in kind tax liability	
Basic Rate (20%) tax payer	£1,162.00
Higher Rate (40%) tax payer	£2,324.00

*Please note this Price Guide provides taxation information as a guide only. Vauxhall does not provide taxation guidance. Drivers should always take professional advice on their own tax position.
 **Excludes residents of Scotland.

BiK for Scottish Residents

Effective 6 April 2018 the Scottish Government have introduced their own BiK taxation structure. This only applies to Company Car Drivers that are Scottish taxpayers. HMRC will determine whether or not an individual is a Scottish taxpayer based on where their main place of residence is.

The BiK rates for Scotland are:

- Over £12,570 – £14,732 Starter Rate 19%
- Over £14,732 – £25,688 Basic Rate 20%
- Over £25,688 – £43,662 Intermediate Rate 21%
- Over £43,662 – £150,000 Higher Rate 41%
- Above £150,000 Top Rate 46%

To calculate your own personal liability, click the link [Vauxhall BiK Tool](#)

CO ₂ (g/km)	Electric range (miles)	% 2023 – 24 tax year
0	-	2%
1 – 50	130+	2%
1 – 50	70 – 129	5%
1 – 50	40 – 69	8%
1 – 50	30 – 39	12%
1 – 50	<30	14%
51 – 54	-	15%
55 – 59	-	16%
60 – 64	-	17%
65 – 69	-	18%
70 – 74	-	19%
75 – 79	-	20%
80 – 84	-	21%
85 – 89	-	22%
90 – 94	-	23%
95 – 99	-	24%
100 – 104	-	25%
105 – 109	-	26%
110 – 114	-	27%
115 – 119	-	28%
120 – 124	-	29%
125 – 129	-	30%
130 – 134	-	31%
135 – 139	-	32%
140 – 144	-	33%
145 – 149	-	34%
150 – 154	-	35%
155 – 159	-	36%
160+	-	37%

Vehicle Excise Duty†

The amount of Vehicle Excise Duty (road fund licence) payable on new cars varies depending on the level of carbon dioxide (CO₂) emissions produced by the vehicle. CO₂ emissions are measured in grams per kilometre (g/km) travelled and divided into 13 charging bands shown in the table below.

A 'first year rate' of Vehicle Excise Duty is payable on all new cars and in subsequent years the amount payable reverts to a different rate. Also, for vehicles with a list price over £40,000, including factory-fitted options, an additional £410 is payable for five years after registration.

VED Band	CO ₂ (g/km)	First year rate Petrol/ Diesel	First year rate Hybrid/ Electric
A	0	£0	£0
B	1 – 50	£10	£0
C	51 – 75	£30	£20
D	76 – 90	£135	£125
E	91 – 100	£175	£165
F	101 – 110	£195	£185
G	111 – 130	£220	£210
H	131 – 150	£270	£260
I	151 – 170	£680	£670
J	171 – 190	£1,095	£1,085
K	191 – 225	£1,650	£1,640
L	226 – 255	£2,340	£2,330
M	Over 255	£2,745	£2,735

†Correct at time of issue.

Fleet Toolbox

The Fleet Toolbox has a host of useful calculators, comparators, interactive listings and information.

Click the link for more information

[Vauxhall Fleet Tool Box](#)

Contact Vauxhall Fleet

Please contact one of our dedicated sales teams who will be happy to help with your particular enquiry.

Fleet Decision Makers

Depending on the size of your fleet of vehicles, we have a dedicated team to handle your enquiries. The lines are open Monday to Friday excluding Bank Holidays.

1 – 24 vehicles

Call: 0203 885 4560 (8:30am – 5:00pm)

Email: enquiries@stellantis-fleet.co.uk

50+ vehicles

Call: 0203 885 4562 (8:30am – 5:00pm)

Email: enquiries@vauxhallfleet.co.uk

Special Vehicles (Police, Fire and Ambulance)

Email: psvo@stellantis.com

For more information visit vauxhall.co.uk/fleet

Further information

On-the-road prices

To eliminate uncertainty about hidden costs when buying a new car, Vauxhall publishes on-the-road recommended retail prices (RRP) and these are shown in the pricing tables within this price guide. These prices include VAT, number plates and delivery to Retailer of £900.00 (including £150.00 VAT), 12 months' Government Vehicle Excise Duty and the DVLA new vehicle first registration fee of £55.00.*

Please note: The on-the-road recommended retail price (RRP) does not include fuel supplied by the Retailer, motor insurance or any other goods or services supplied by agreement between the Retailer and the customer.

Price protection

Order a new Vauxhall for build in the current model year (as confirmed by your Retailer) for delivery no more than three months in advance and the price you are quoted is the price you pay. This is irrespective of any subsequent price rises between placing your order and delivery of your new car, but you must take delivery as soon as the car is available. Please note: Vauxhall Motors Limited is not liable for price adjustments caused by Government changes in the rate of VAT (currently 20%), Vehicle Excise Duty, DVLA new vehicle first registration fee or by any other applicable legislation or regulations.

Customer Care Commitment

For added peace of mind, Vauxhall has an innovative Customer Care Commitment that offers the following:

- Three-year vehicle warranty consisting of a one year/unlimited mileage manufacturer's warranty and a second and third year manufacturer's warranty with a 60,000 miles limitation

- Vauxhall Assistance for 12 months from first registration
- Six years' body panel anti-perforation warranty

Please note: Warranty is only available on vehicles sourced from Vauxhall Motors Limited. Terms and conditions apply – please see your Vauxhall Retailer for details.

Vauxhall Assistance

Vauxhall Assistance is provided automatically with every new Vauxhall for 12 months from first registration and covers everything from accident assistance, roadside recovery and 'at home' service to flat tyres. For even more peace of mind, on fully electric models, the cover is extended** to 3 years. Even more reason for you to stay calm and let us take care of everything should the need arise. With Vauxhall Assistance help is literally just a free[†] phone call away, 24 hours a day, 365 days a year!

LEASYS

Leasys UK

Leasys is the proud Business Contract Hire partner of Vauxhall and consequently, can provide quick vehicle delivery to keep your business mobile. Specialised in Medium to Long-Term Leasing options and Fleet Management solutions for businesses of all sizes, [Leasys](#) lead mobility by offering sustainable and innovative solutions designed around customers, for a best-in-class experience. Their team of experts can personally support you and provide dedicated consultation. [Leasys](#) is equally owned by Stellantis and Crédit Agricole Consumer Finance and is a member of the British Vehicle Rental and Leasing Association (BVRLA). For further information, please contact your local Vauxhall Retailer or visit [leasys.com/uk](#)

In the event of an accident

Vauxhall Accident Management helps keep you mobile following an accident. Benefits include vehicle recovery, Vauxhall-approved repairs and contacting your insurer. For more details, visit [vauxhall.co.uk/AccidentManagement](#)

Vauxhall Flexcare – Service Plans and Extended Warranty

Designed for your peace of mind. A collection of extended warranty and service plans to match the way you drive.

Extended Warranty

An extended warranty for your Vauxhall offers you similar cover for material or manufacturing defects beyond the original warranty period on the vehicle. By choosing an official Vauxhall Extended Warranty, we guarantee that any repairs you need are carried out by Vauxhall trained technicians using genuine Vauxhall parts.

Service Plans

There's no need to worry about budgeting for your next service. Simply take out a Vauxhall Fixed Price Service Care Plan. You can then focus on the more important things in life, knowing your servicing costs are taken care of. For more information, click on the link below or call us on **0345 600 2065**. See [vauxhall.co.uk/discover/here-for-you.html](#)

Vauxhall Service Club

A world of servicing, repair and accessory benefits with Vauxhall Service Club is available for all Vauxhall owners, and it's free to join via the MyVauxhall app (terms and conditions apply). For a list of benefits and details on how to join visit: [vauxhall.co.uk/serviceclub](#)

Vauxhall Insurance with added reassurance

Join the family or find out more about Vauxhall Insurance Services by contacting our insurance team on **0330 678 1130^{††}**, or visit: [vauxhall.co.uk/offers-finance/insurance.html](#)

Vauxhall Accessories

From the small things that make life easier to the big things that make life exciting – personalise your Vauxhall with Vauxhall Accessories. So what are you looking for? A device holder, roof box, or even splash guards? Whatever it is we've got the solution for you. With our huge accessory range, all tailor-made for your Vauxhall and come with a full year's warranty. For further details visit your local Retailer or see [vauxhall.co.uk/owners/accessories.html](#)

Protecting the environment

Vauxhall's commitment to the environment is demonstrated by our products' many environmental awards. For even more information on Vauxhall's efforts to achieve an environmentally sustainable future, and how to dispose of your end-of-life vehicle, see [vauxhall.co.uk/recycling](#)

For more product information

For further information on the Vauxhall range or location of your nearest Vauxhall Retailer please call **0800 026 0034**. Alternatively, details can be found on our website at [vauxhall.co.uk](#)

VAUXHALL

For more information call **0800 026 0034**

For Fleet enquiries call **0203 476 2268**

Discover the full Vauxhall range at **[vauxhall.co.uk](https://www.vauxhall.co.uk)**

Join us online

The invoice price, including delivery to Retailer, factory-fitted options, accessories fitted by the Retailer and number plates, is subject to VAT. Some feature descriptions in this guide may refer to, and some illustrations may show, optional equipment not included in the standard delivery. The information contained in this guide was accurate at the time of publication. We reserve the right to make changes in design and equipment. Please note that Vauxhall Retailers are not the agents of Vauxhall Motors Limited and are not authorised to bind Vauxhall Motors Limited by any specific or implied undertaking or representation. It is advisable to ensure that your motor insurance policy provides adequate cover for additional fitted options and accessories. The colours in this guide are only approximate actual colours. Illustrated optional equipment is available at extra charge. Availability, technical features and equipment provided on our vehicles can vary by model. For precise information on the equipment provided on our vehicles, please contact your local Vauxhall Retailer.

Price and Specification Guide
13 March 2024 | Model Year 2024A



New Combo Life

All Electric Range

Contents

To find the information you want use the links below to navigate around the guide:

[Choose Your Trim Level](#)

[Range Highlights](#)

[Models](#)

[Prices](#)

[Features/Options](#)

[Infotainment](#)

[Interior Style and Comfort](#)

[Exterior Colours](#)

[Wheels and Tyres](#)

[Specifications](#)

[Dimensions and Capacities](#)

[Accessories](#)

[Company Car Information](#)

[Further Information](#)



Effective 13 March 2024

New Combo Life Model Year 2024A

Choose Your Trim Level



Design

VAUX-HALL-COMBO-LIFE-MY2023-BEV-EXTERIOR-WHITE-INT-05-Sg.jpg

First up in the range is the Combo Life Electric Design, which is packed with plenty of practical features as standard. Choose from 5- or 7-seats.

Ultimate

VAUX-HALL-COMBO-LIFE-MY2023-BEV-EXTERIOR-WHITE-INT-05-Sg.jpg

Combo Life Electric Ultimate completes the range, with a little more exterior style and extra comfort features.

Combo Life Range Highlights

Design

Standard features include:

- Multimedia audio system
 - IVI MID: Radio AM/FM/DAB
 - 10" HD Touch screen with Mirror Screen (WiFi)
 - 4G connectivity + voice control + E-call + A-call
 - Two speakers & two tweeters
 - Apple CarPlay/Android Auto
- Vauxhall Connect
- 10-inch colour instrument display
- Six-way driver's seat with lumbar adjustment
- Panels for regenerative braking;
 - Light, Medium, Strong
- Four-way passenger seat with storage on back of seat
- 1/3 – 2/3 rear folding second-row bench seats
- Electronic parking brake
- Nearside and offside sliding side-access door with opening windows
- Tailgate with opening heated rear window and wiper
- Body-colour front and rear bumpers
- Black side-protection mouldings
- Body-colour door handles and side-access door rail covers
- Front fog lights
- 16-inch alloy wheels
- Electrically adjustable/foldable/heated door mirrors
- Rain-sensitive windscreen wipers
- High beam assist

- Electrically operated front and rear windows
- Dark-tinted rear windows
- Daytime running lights
- Rear parking distance sensors
- Advanced emergency braking system
- Electronic stability control and ABS with hill start assist
- Forward collision alert
- Lane keep assist
- Cruise control with speed limiter
- Intelligent speed assistance speed limit information

Design XL 7-seat

XL 7-seat models additionally feature:

- Two individual split-folding and removable third-row seats
- Sliding facility for third-row seats

Ultimate

Features over Design models:

- Multimedia Navi Pro system
 - Satellite navigation
- Chrome-effect instrument rings
- Body-colour side-protection mouldings
- Panoramic rear-view camera
- LED daytime running lights
- Dual-zone electronic climate control
- Alloy-effect protective front skid plate
- Black painted door mirrors
- 33/33/33 split-folding second-row seats with fold-flat facility



Combo Life Electric Design



<No intersecting link>

Design OTR from £32,180

Infotainment:

- Multimedia audio system
 - IVI MID: Radio AM/FM/DAB
 - 10" HD Touch screen with Mirror Screen (WiFi)
 - 4G connectivity + voice control + E-call + A-call
 - Two speakers & two tweeters
 - Apple CarPlay/Android Auto
- Vauxhall Connect

Interior convenience/styling:

- Full roof finish with overhead storage
- 10" digital cluster
- Six-way driver's seat with lumbar adjustment
- Panels for regenerative braking;
 - Light, Medium, Strong
- Four-way passenger seat with storage on back of seat
- Fabric carpet floor trim (Row 1, 2, 3)
- Air conditioning
- Polyurethane steering wheel
- Steering wheel mounted audio controls
- 1/3 - 2/3 rear folding second-row bench seats
- Chrome-effect interior door handles
- Luggage compartment cover
- Chrome-effect instrument rings
- Electronic parking brake
- 12 volt socket in dashboard
- Central rearview mirror - black painted cover
- 4 tie bracket points on lower trunk area

Exterior convenience/styling:

- Two sliding doors with tinted opening window, two tinted non-opening windows in row 3
- Body-colour front and rear bumpers

- Black side-protection mouldings
- Offside opening window, 2 opening windows row 3
- Tailgate with opening heated rear window and wiper
- Body-colour door handles and side-access door rail covers
- Front fog lights
- 16" Steel wheels with full size hubcap
- Toolbox
- Roof bar predisposition
- Electrically adjustable heated door mirrors
- Rain-sensitive windscreen wipers
- High beam assist
- Electrically operated front windows
- Daytime running lights
- Matrix LED headlights

Safety/security:

- Rear parking distance sensors
- Advanced emergency braking system
- Electronic stability control and ABS with hill start assist
- Forward collision alert
- Lane keep assist
- Automatic lighting control
- Cruise control with speed limiter
- Intelligent speed assistance speed limit information
- Six airbags
- Driver attention alert
- Tyre pressure monitoring system

Design XL 7-seat

OTR from £33,080

- 7-seat models additionally feature:**
- Two individual tiltable and removable third-row seats
 - Sliding facility for third-row seats

Combo Life Electric Ultimate



<No intersecting link>

Ultimate OTR from £34,695

Infotainment:

- Multimedia audio system
 - IVI MID: Radio AM/FM/DAB
 - 10" HD Touch screen with Mirror Screen (WiFi)
 - 4G connectivity + voice control + E-call + A-call
 - Four speakers & two tweeters
 - Apple CarPlay/Android Auto
 - 1 x USB Type C (Data & charge), 1 x USB Type C (Charge Only)
- Vauxhall Connect

Interior convenience/styling:

- 10" digital cluster
- Six-way driver's seat with lumbar adjustment
- 4 tie bracket points on lower trunk area
- Electronic dual-zone climate control
- Full roof finish with overhead storage
- Steering wheel mounted audio controls
- 33/33/33 split-folding second-row seats with fold-flat facility
- Chrome-effect interior door handles
- 12 volt socket in dashboard and row 2
- Luggage compartment cover
- Chrome-effect instrument rings
- Heated leather steering wheel
- Panels for regenerative braking; Light, Medium, Strong
- Individual codriver seat with armrest. Electric, heated and massage
- Central rearview mirror - black painted cover
- Front-seat back pockets
- Fabric carpet floor trim (row 1, 2, 3)
- Two foldable tables with cupholders
- Electronic parking brake

Exterior convenience/styling:

- Nearside and offside sliding side-access door with opening windows
- Dark tinted rear tailgate with opening heated rear window and wiper
- Body-colour front and rear bumpers with skidplate
- Painted shiny black side protection mouldings
- Body-colour door handles and side-access door rail covers
- Black painted door mirrors
- Front fog lights
- 16-inch alloy wheels
- Toolbox
- Roof rails
- Electrically adjustable/foldable/heated door mirrors
- Rain-sensitive windscreen wipers
- High beam assist
- Electrically operated front and rear windows
- Dark-tinted rear windows
- Panoramic rear-view camera
- Matrix LED headlights

Safety/security:

- Rear parking distance sensors
- Advanced emergency braking system
- Electronic stability control and ABS with hill start assist
- Forward collision alert
- Lane keep assist
- Automatic lighting control
- Cruise control with speed limiter
- Intelligent speed assistance speed limit information
- Six airbags
- Driver attention alert
- Tyre pressure monitoring system
- Digital Visiopark 180

Combo Life Electric Prices

	Electrical Range	LCDV Code	Price (£)	VAT (£)	Total (£)	On-the-road Costs	On-the-road RRP (£)	P11D Value (£)	2023/24 BIK %
Design (5-seat)									
100kW (136PS) auto – 50kWh battery	199	1GK9AF8ZIFT0A070	26,021.00	5,204.20	31,225.20	955	32,180.20	32,125.20	2%
Design XL (7-seat)									
100kW (136PS) auto – 50kWh battery	199	1GK9CL8ZIFT0A070	26,771.00	5,354.20	32,125.20	955	33,080.20	33,025.20	2%
Ultimate (5-seat)									
100kW (136PS) auto – 50kWh battery	199	1GK9AF5ZIFT0A070	28,117.00	5,623.40	33,740.40	955	34,695.40	34,640.40	2%

WLTP Combined CO₂ (g/km) figures are based on a configured vehicle as per LCDV code for UK with no options fitted.

Please note: On-the-road recommended retail prices (RRP) include number plates and delivery to Retailer of £900.00 (including £150.00 VAT), 12 months' Vehicle Excise Duty and new vehicle first registration fee of £55.00. Excludes fuel and insurance. Company Car Benefit in Kind (BiK) rates are monthly based on the standard paint price. Price has been calculated using manufacturer estimates. Retailers may be required to carry out more than one credit check during the course of the order process. You may be required to place a deposit when placing your order with your supplying Retailer. In the event of a price change, deposit refunds will be governed by your supplying Retailer's policy and as such must be discussed with the supplying Retailer.

Combo Life Prices

Only available for conversion to a wheelchair accessible vehicle

	LCDV Code	Fuel Type	Price (£)	VAT (£)	Total (£)	On-the-road RRP (£)	Financial Year 2023/24 BiK 20% (£)	WLTP Combined CO ₂ (g/km) [#] - LCDV Code	Insurance Groups
Design (5-seat)									
1.5 (100PS) Turbo D	1GK9AF8P6KT0A070	Diesel				Pricing available upon request to Vauxhall fleet sales team		TBC	TBC
1.5 (130PS) Turbo D auto	1GK9AF8P41T0A070	Diesel				Pricing available upon request to Vauxhall fleet sales team		TBC	TBC
Design XL (7-seat)									
1.5 (100PS) Turbo D	1GK9CL8P6KT0A070	Diesel				Pricing available upon request to Vauxhall fleet sales team		TBC	TBC
1.5 (130PS) Turbo D auto	1GK9CL8P41T0A070	Diesel				Pricing available upon request to Vauxhall fleet sales team		TBC	TBC

Combo Life's diesel engines meet the Real Driving Emissions Step 2 (RDE2) standards.

WLTP Combined CO₂ (g/km) figures are based on a configured vehicle as per LCDV code for UK with no options fitted.

[#]Fuel consumption and CO₂ figures are determined according to the WLTP test cycle. CO₂ figures, BiK values and RRP pricing shown above are for a standard vehicle without any additional optional equipment. CO₂ figures are used to calculate Vehicle Excise Duty (VED) for the first registration of the vehicle and BiK. The addition of optional extras could increase the certified CO₂ emission output. This in turn may affect the amount of VED payable upon registration, and, for company car drivers, the P11D value and the amount of Benefit in Kind (BiK) tax payable. Figures shown are for comparison purposes and should only be compared to the fuel consumption and CO₂ values of other cars tested to the same technical standard. The fuel consumption achieved, and CO₂ produced, in real world conditions will depend upon a number of factors including, but not limited to: the accessories fitted (pre and post registration); variations in weather; driving styles and vehicle load. The WLTP (Worldwide Harmonised Light Vehicles Test Procedure) is used to measure fuel consumption and CO₂ figures. Full data relating to WLTP test cycles can be found at: www.vauxhall.co.uk/wltp

Safety

Standard Features – The following features are standard across the entire Combo Life range.

Airbags

- Driver's airbag
- Front passenger's airbag
- Two front seat side-impact airbags
- Full-size curtain airbags

Seating

- Three height adjustable rear seat head restraints

Seatbelts

- Lap and diagonal inertia-reel seatbelts
- 'Seatbelt unfastened' audible warning and warning light

Braking

- Automatic emergency braking – The system works automatically in conjunction with forward collision alert, at speeds between 3mph and 70mph, and detects both vehicles and pedestrians. If no avoiding action is taken by the driver, at speeds below 19mph the system automatically slows the vehicle to a full stop with emergency braking of 0.9g. At speeds from 19mph to 70mph it brakes automatically to reduce speed by a maximum of 30mph – to reduce speed even further the driver must brake themselves

- Anti-lock Braking System (ABS)
- Electronic brakeforce distribution – Automatically apportions the optimum braking force to each wheel
- Engine drag torque control – Improves directional stability by preventing the driven wheels from locking on slippery surfaces under the influence of engine braking
- Hill start assist – Briefly maintains rear brake pressure to stop the vehicle rolling back on an incline

Child safety

- Deactivation switch for front passenger's front and side-impact airbags
- ISOFIX child seat mountings incorporating top tether anchor points located on second-row rear seats (does not include child seat) – Allows ISOFIX child safety seats to be securely fixed into the car. The ISOFIX mounting system reduces forward movement in an accident and makes the child seat easier to install
- Child-proof locks on rear doors

Stability

- Electronic Stability Programme (ESP) – ESP monitors many different inputs to determine when the car starts to lose traction, it can then immediately respond by varying the brake pressure between up to three wheels and adjust the engine output to help correct the loss of traction and improve stability

Additional ESP features

- Traction control
- Cornering brake control
- Straight line stability control
- Drag torque control – Maintain stability on slippery roads when lifting off the accelerator or changing gear

Tyre pressure

- Tyre pressure monitoring system

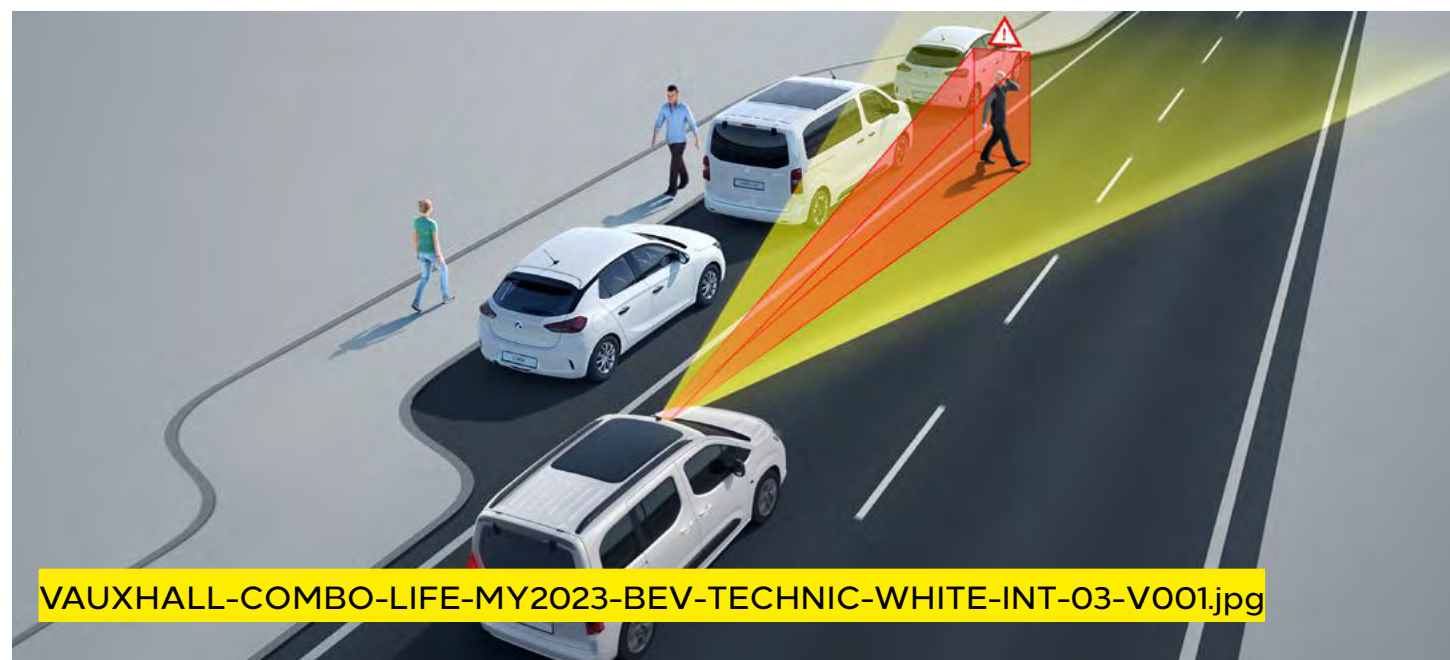

Automatic emergency braking.



ISOFIX child seat mountings.

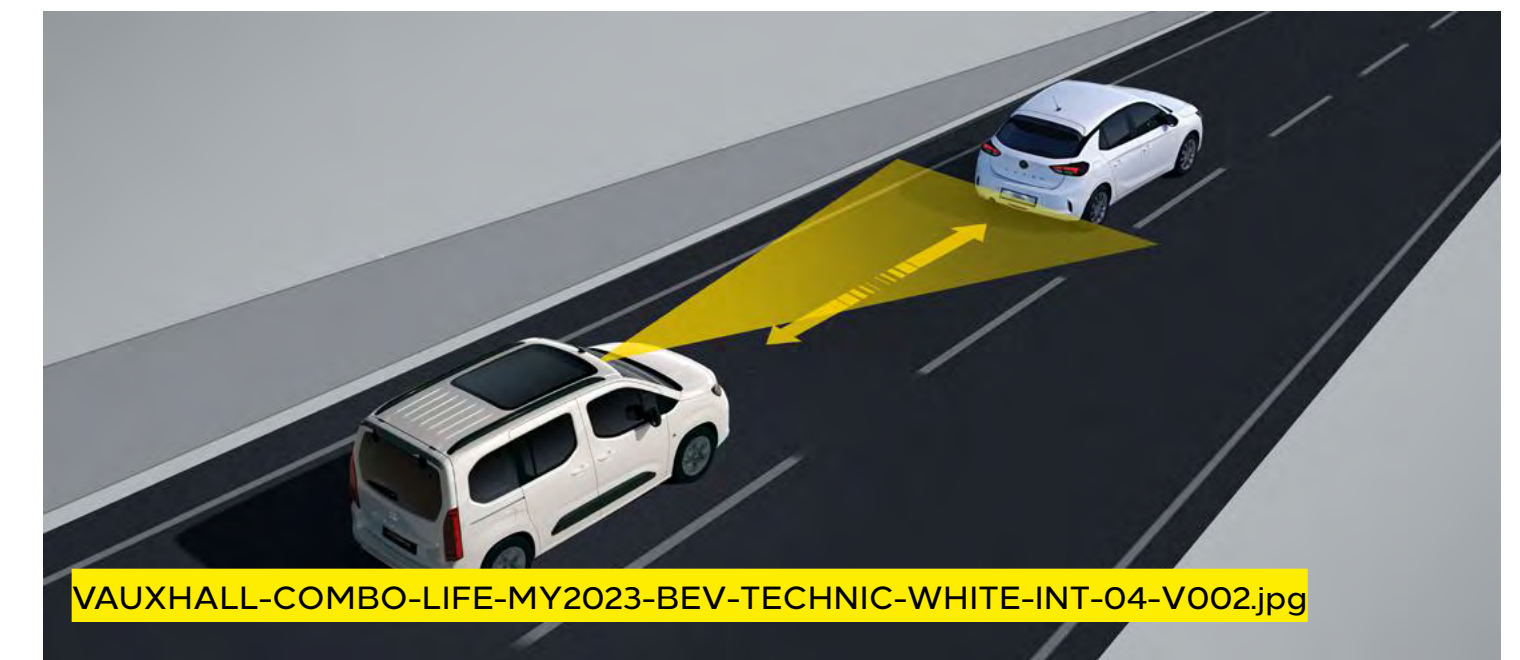

Lane keeping assist (see next page for feature description).

Driver Assistance

Standard Features – The following features are standard across the entire Combo Life range. Specific features by model are outlined in the separate tabular information.

Cruise control with speed limiter

With steering wheel mounted controls. Enables you to maintain a constant speed, making it ideal for economical motorway driving.

Steering

- Speed sensitive electrically assisted power steering
- Reach and rake adjustable steering column

Front camera system

A range of class-leading driver assistance and safety features are controlled by the front camera system

Forward collision alert

The system operates automatically from 3mph and gives an audible warning as well as a visual warning when approaching another vehicle too quickly

Speed sign recognition

Detects and then displays speed limits, reducing uncertainty and the risk of speeding.

- Recognises different speed signs, including temporary speed restrictions
- Displays reminder in the instrument cluster

Driver attention alert

The system monitors driving time and driving behaviour to help prevent accidents caused by tiredness

Lane keeping assist

If the driver has not actively steered or signalled, the system performs corrective steering actions to help prevent the vehicle crossing painted boundary lines or road side edges.

Wipers

- Intermittent rear window wash/wipe
- Magic Wash System – Mounted in the front windscreen wipers, Combo Life Electric models benefit from our innovative windscreen wash system, designed to more effectively distribute water and reduce wastage. Using nozzles located above the wiper blades, fluid is distributed as the wiper sweeps the windscreen. This avoids the ‘temporary blindness’ of more conventional bonnet mounted systems between fluid release and wiper sweeping, improving visibility

Model Specific Features/Option

	Option code	Design	Ultimate
Driver Assistance			
Digital Visiopark 180	QK13	£150	●
Rear parking distance sensors		●	●
High beam assist		●	●
Rain-sensitive windscreen wipers		●	●
Drive Assist Pack - Highway Integrated Assist (HIA) - Adaptive Cruise Control with Stop & Go (ACC) - Lane Positioning Assist (LPA) - Extended Panels Recognition (e-TSR) - AEBS3	ZVLO		£1,100

Driver Information and Security

Standard Features – The following features are standard across the entire Combo Life range. Specific features by model are outlined in the separate tabular information.

Driver Information

Instrumentation

- Speedometer and rev counter
- Digital fuel gauge with low fuel level warning light
- Digital water temperature gauge with warning light
- Shift-up/down indication light – Indicates when to change gear for optimum fuel economy

Driver information display

(centrally located in instrument cluster)

- Trip computer data
- Total mileage
- Service-due indicator
- Tyre pressure monitoring system

Multi-function trip computer

(displayed on driver information display)

- Trip mileage
- Vehicle range
- Average speed
- Driving time

Central facia display

(format dependent on infotainment unit)

- Audio information
- Digital clock with automatic RDS time adjustment
- Outside air temperature with ice warning function
- Additional features dependent on infotainment unit (see infotainment for details)

Security

- ‘Key left in ignition’ audible warning
- Electronically protected audio equipment
- Engine deadlock immobiliser
- Visible Vehicle Identification Number (VIN)
- Locking wheel bolts for alloy wheels
- Freewheeling door locks

Remote control central locking

- Operates on doors, tailgate and fuel filler flap
- Deadlocking
- Central locking activation switch on driver’s door

Model Specific Features/Option

	Option code*	Design	Ultimate
Driver Information			
10” Multimedia Pro		●	●
10” Digital Cluster		●	●
Security			
Remote control ultrasonic security alarm system	DAB13	£200	£200

*Optional at extra cost including VAT.

Convenience

Standard Features – The following features are standard across the entire Combo Life range. Specific features by model are outlined in the separate tabular information.

Interior Convenience

- Front 12-volt electrical accessory socket
- Driver’s sun visor incorporating vanity mirror with cover
- Dipping rear-view mirror
- Steering wheel mounted audio controls
- Front and rear USB connection

Interior Storage

- Two fascia-mounted drinks holders
- Two drinks holders in centre console
- Large open storage pocket behind infotainment screen
- Interior courtesy light
- Front map reading lights
- Luggage compartment lighting
- Small open storage compartment behind gear knob
- Two front large and small door pockets
- Two rear door pockets
- Open storage compartment below glovebox
- Full-width overhead storage shelf with ambient lighting

Luggage Area

- Luggage compartment cover
- Illuminated load area
- Fully carpeted load area
- Interior tailgate handle
- Four load restraint lashing eyes
- Twin gas-assisted tailgate struts

Interior Lighting

- Central front courtesy light
- Central rear courtesy light
- Fade up/fade down

Model Specific Features

	Option code	Design	Ultimate
Interior Convenience			
Fold-flat front passenger seat with armrest		●	●
Electronic parking brake (EV only)		●	●
Manual parking brake		●	
Two foldable tables with cupholders		●	●
Front-seat back pockets		●	●

Convenience

Standard Features – The following features are standard across the entire Combo Life range. Specific features by model are outlined in the separate tabular information.

Heating and Ventilation

- Air recirculation facility
- Cabin particulate filter – Removes dust, airborne particles and pollen
- Four-speed fan
- Illuminated controls
- Four adjustable facia vents
- Windscreen demist vents
- Side window demist vents
- Rear heating duct

Exterior Convenience

Door mirrors

- Twin electrically adjustable/heated door mirrors

Windows

- Solar heat-absorbing windscreen
- Electrically operated front and rear windows with safety autoreverse and one-touch up/down facility
- Tailgate with heated window and wash/wipe facility

Model Specific Features

	Option code	Design	Ultimate
Heating and Ventilation			
Air conditioning		●	
Dual-zone electronic climate control			●
Exterior Convenience			
Electrically foldable door mirrors			●
Electric heated door mirrors		●	●
Rear tailgate with heating system and wiper		●	
Dark tinted rear tailgate window with heating system and wiper			●
Roof rails*		●	●

*Please note, roof rail design may differ from that illustrated within this guide. Please consult your Retailer for details.

Exterior Style and Lighting

Standard Features – The following features are standard across the entire Combo Life range.
Specific features by model are outlined in the separate tabular information.

Exterior Styling

- Chrome-effect front grille bar
- Body-colour door handles
- Body-colour bumpers and sliding rail cover

Exterior Lighting

- Automatic lighting control
- Front fog lights
- LED side repeat indicators
- Lights-on audible warning – When driver’s door is opened an audible warning sounds to alert the lights have been left on
- Manual headlight beam levelling. Use to adapt headlight range to the vehicle load to prevent dazzling
- Rear fog light
- Reversing light
- Hazard warning lights

Model Specific Features

	Option code	Design	Ultimate
Exterior Styling			
Dark-tinted rear windows			●
Painted shiny black side protection mouldings			●
Black side protection mouldings		●	
Shiny black painted door mirrors		●	●
Exterior Lighting			
Matrix LED Headlights		●	●

Infotainment

Standard Features

Multimedia with 10-inch touchscreen Standard on Design and Ultimate models

Onboard features:

- AM/FM stereo radio • DAB Digital radio
- RDS with Traffic Programme • Four speakers

Media connections:

- Apple CarPlay • Android Auto™
- Smartphone projection
- 2x USB Type C Connections

Mobile phone portal:

- Bluetooth® connectivity
- Vehicle microphone
- Handsfree calls via steering wheel controls
- Phone book access

Vauxhall Connect*

Standard on Combo Life Electric Design and Ultimate models

e-Call and b-Call:

Help when you need it, 24/7, 365 days a year, that's what you get with new Vauxhall Connect. In an emergency or breakdown, you'll be put in touch with a trained advisor, with just the touch of a button.

Live Navigation Plus and more:

You can also access live navigation services, receive regular vehicle diagnostic info plus there's a host of remote convenience features available through the MyVauxhall app.

Additional features:

- 10-inch colour touchscreen
- Steering wheel mounted audio controls
- Flexible roof-mounted aerial

- **Peace of mind:** emergency call, breakdown call and regular vehicle status and information
- **Convenience:** remote functions (e.g. lock/unlock the door).
- **Our additional services for electric vehicles:** trip planning, remote settings or public charging solutions – we keep you going!
- **Smart driving:** enjoy a relaxed ride thanks to live navigation and trip management
- **Traffic alerts:** Live Navigation Plus introduces speed camera, traffic light camera and accident hotspot alerts



Please note that compatibility and certain functions may be different depending on the type of device and operating system you're using with the Multimedia systems. Apple CarPlay is a trademark of Apple Inc. Apple and iPhone are trademarks of Apple Inc., registered in the U.S. and other countries. Android is a trademark of Google Inc, also registered in the U.S. and other countries. *Services may require a subscription/fee and are subject to mobile network coverage and availability. Standard on models with Satellite Navigation only.

Please note, Android smartphone projection illustrated on 8-inch colour touchscreen on Multimedia Navi Pro audio unit.

Interior Styling and Comfort

Design



Steering wheel:

- Two-spoke Polyurethane foam design

Seat trim:

- Mistral grey with tiles fabric seat trim inserts

Instruments:

- 10-inch colour instrument display
- 10-inch Digital Cluster
- Chrome-effect instrument rings

Front seating:

- Driver's seat (six-way adjustable):
 - Height – Reach – Backrest
 - Manual lumbar adjustment – Armrest
 - Under seat storage – Head restraint
- Passenger's Seat (four-way adjustable):
 - Reach – Backrest – Head restraint
 - Fold flat facility

Ultimate



Steering wheel:

- Two-spoke heated leather design

Seat trim:

- Mistral Grey with tiles fabric seat trim inserts

Instruments:

- 10-inch colour instrument display
- 10-inch Digital Cluster
- Chrome-effect instrument rings

Front seating:

- Driver's seat (six-way adjustable):
 - Height – Reach – Backrest
 - Manual lumbar adjustment – Armrest
 - Under seat storage – Head restraint
- Passenger's Seat (four-way adjustable):
 - Reach – Backrest – Head restraint
 - Fold-flat facility

Interior Styling and Comfort – Rear seating



Model Specific Features

	Option code	Design	Ultimate
Rear Seating			
Height-adjustable and removable head restraints		●	●
Second-row three-person layout 1/3 – 2/3 rear folding seats		●	
Second-row three-person layout 33/33/33 individual split-folding second-row seats with fold flat facility			●
Third-row two-person individual removable seats		XL only	

Exterior Colours

Arctic White (POPR)*
Solid paint

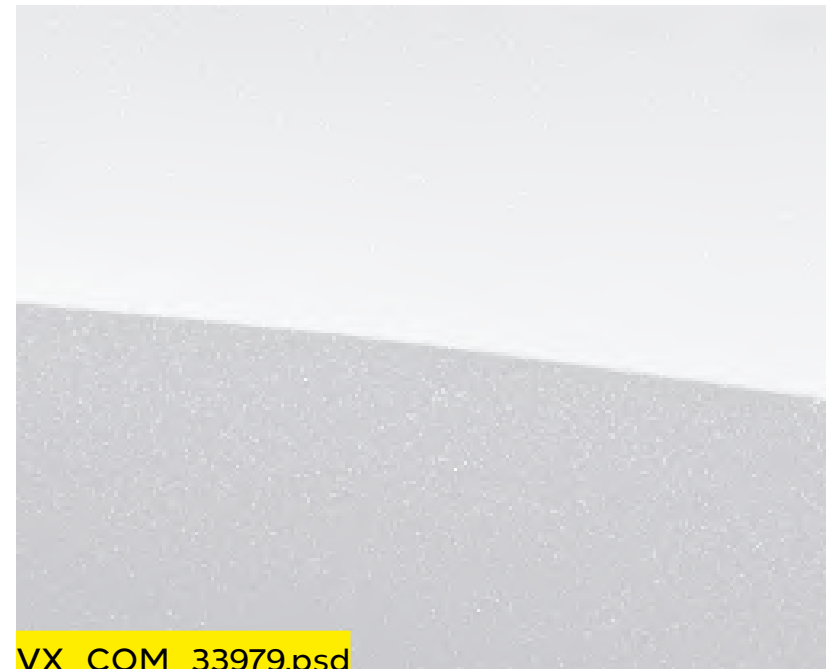

Sirkka Green (M04Q)**
Two-coat metallic paint £570

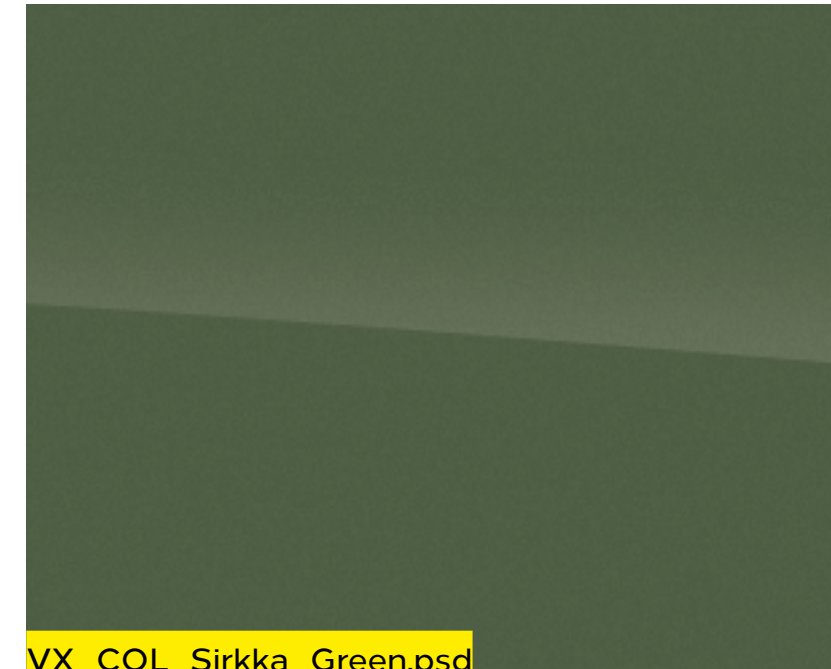

Kiama Blue (ONM6)**
Two-coat metallic paint £570

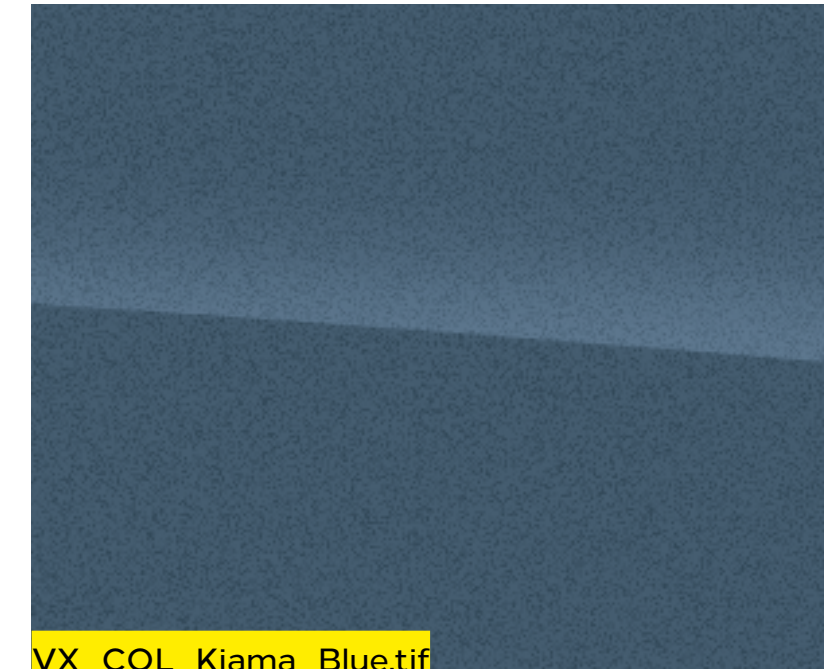

Contrast Grey (MOF4)**
Two-coat metallic paint £570



Carbon Black (M09V)**
Two-coat metallic paint £570

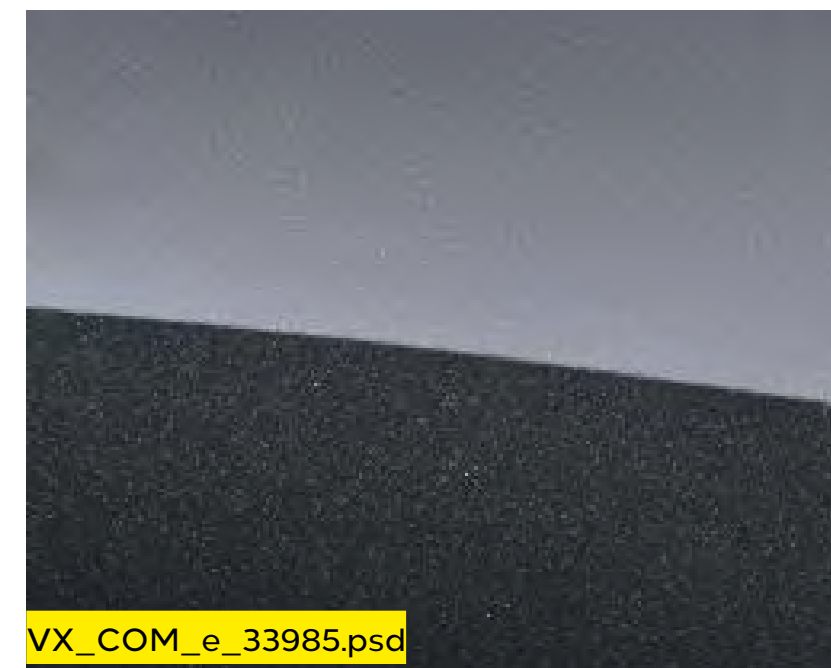



The colours reproduced may vary slightly from the actual paint colour. As a result they should be used as a guide only. Your Vauxhall Retailer has a comprehensive display of our paint samples.

*Standard exterior paint. **Optional at extra cost including VAT.

Wheels and Tyres

Model Specific Features/Option

		Option code	Design	Ultimate
 <p>VX_COM_28612_RRY_JobOnly.psd</p>	<p>16-inch steel wheels with full hubcap</p> <ul style="list-style-type: none"> • 205/60 R 16 tyres • Emergency tyre inflation kit (in lieu of spare wheel) 		●	
 <p>VX_COM_28555_RRZ_JobOnly.psd</p>	<p>16-inch seven-spoke alloy wheels</p> <ul style="list-style-type: none"> • 205/60 R 16 tyres • Emergency tyre inflation kit (in lieu of spare wheel) 			●
	<p>17-inch seven-spoke alloy wheels</p> <ul style="list-style-type: none"> • 205/60 R 16 tyres • Emergency tyre inflation kit (in lieu of spare wheel) 	DZG7		TBC

Performance, Fuel Economy and Emissions

	Performance (manufacturer's figures)		Fuel economy mpg (litres/100km)#		CO ₂ emissions g/km#		Vehicle Excise Duty*		BiK rates from - 2023/24 tax year
	Maximum speed (mph)	Acceleration 0 - 62mph (sec)	Combined Low	Combined High	Combined Low	Combined High	First year rate	Standard rate	
5-seat									
1.5 (100PS) Turbo D	107	12.7	48.7 (5.9)	57.6 (4.9)	143	160	£255	£180	33%
1.5 (130PS) Turbo D automatic	114	tba	45.5 (6.2)	54.3 (5.2)	148	170	£255	£180	33%
XL 7-seat									
1.5 (100PS) Turbo D	106	13.0	47.8 (5.9)	57.6 (4.9)	146	160	£255	£180	33%
1.5 (130PS) Turbo D automatic	114	tba	54.3 (5.2)	45.5 (6.2)	152	170	£645	£180	34%

<No intersecting link>

#Figures shown are for comparison purposes and should only be compared to the fuel consumption and CO₂ values of other cars tested to the same technical standard. The fuel consumption achieved, and CO₂ produced, in real world conditions will depend upon a number of factors including, but not limited to: the accessories fitted (pre and post registration); variations in weather; driving styles and vehicle load. The WLTP (Worldwide Harmonised Light Vehicles Test Procedure) is used to measure fuel consumption and CO₂ figures. The CO₂ figures display a range to reflect the highest value for the highest emitting version with all available options added, through to a minimum value to represent the lowest emitting version in standard specification. *Correct at time of publication.

Combo Life Electric Specifications*

Single-speed electronic drive selector

As the motor is an all-electric single-speed drive unit, there is no need for multiple gears. Instead, the shifter lets the driver select from the following:

- Park
- Reverse
- Neutral
- Drive
- Braking (for increased regenerative braking)

Drive Mode Selector

The driver can determine the driving style through selecting one of the following modes:

- **Power:** with high power reserves for the highest top speed and torque. Recommended at full capacity
- **Normal:** for a balanced drive that offers a compromise between performance and energy efficiency. WLTP range is validated in this mode
- **ECO:** for maximum range and energy efficiency. The ECO mode deactivates all unnecessary energy-consuming features and reduces the top speed, torque and overall performance

Braking

Energy recuperation

The regenerative braking system works when the vehicle is in motion, energy created by the resistance of the brakes against the drivetrain is converted into DC voltage to partially recharge the battery. The driver can also engage braking mode through the drive selector to increase the level of energy recuperation.

Single foot driving experience

The system not only utilises the energy when the brakes are being used, but also engages when the vehicle is coasting, recovering more energy and enabling single foot driving as the brakes automatically engage when the throttle pedal is released.

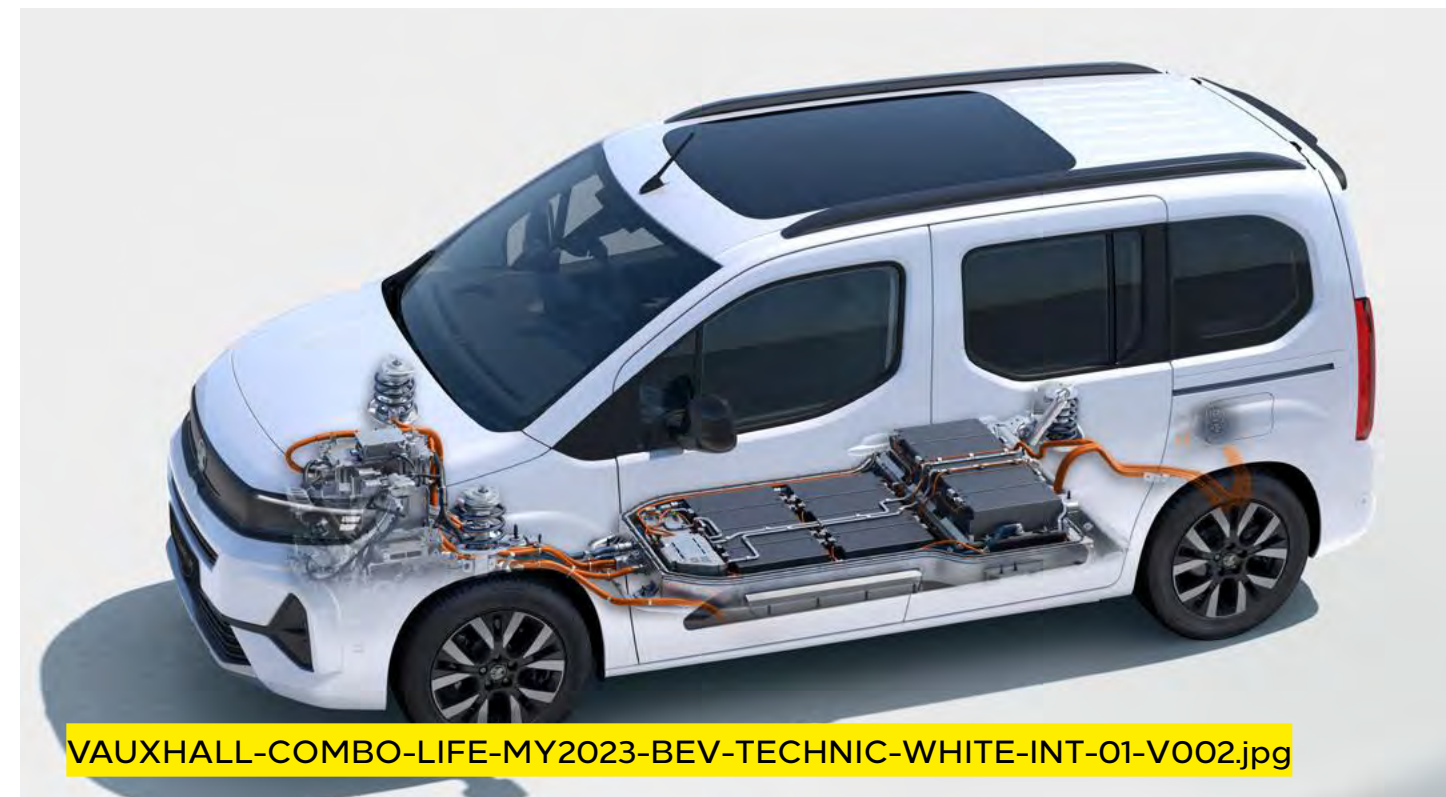

Drivetrain		
CO ₂ emissions	0g/km	
Maximum power	100kW (136PS)	
Maximum torque	260Nm (192lb. ft.)	
Acceleration 0 – 62mph	11.7 sec	
Maximum speed	81mph	
Transmission	Automatic electric drive with fixed gear ratio	
Service interval	Every 25,000 miles or 2 years (whichever comes sooner) Initial inspection at 12,500 miles or 1 year (whichever comes sooner)	
Electric range	199 miles (WLTP preliminary)	
Weights kg		
	5-seat	XL 7-seat
Gross vehicle weight	2366 – 2387	2376 – 2396

The Combo Life Electric is a battery electric vehicle requiring mains electricity for charging. Range data given has been determined according to WLTP test procedure methodology. The figures shown are intended for comparability purposes only and should only be compared to other cars tested to the same technical standard. The range you achieve under real world driving conditions will depend upon a number of factors, including but not limited to: the accessories fitted (pre and post registration); charging frequency; personal driving style; vehicle load and route characteristics; variations in weather; heating/air conditioning; pre-conditioning and battery condition. For more information, contact your local Vauxhall Retailer.

*Provisional data.

Combo Life Electric Specifications*

Charging

Combo Life Electric comes fitted with an 7.4kW on-board charger and mode 3 cable. An 11kW on-board charger is available as an extra cost option at **£360 inc VAT**.

The charging flap's Padlock LED lights up when the cable is correctly plugged in and locked and then acts as a user interface to show the charging status via coloured LED lights:

- **White:** welcome light that helps to light up the area, especially useful in dark conditions
- **Flashing green:** charging in progress
- **Solid green:** charging complete
- **Solid blue:** delayed charging toggled; changes to flashing green when charging commences
- **Solid red:** malfunction

The driver may also choose from two settings:

- **Immediate charging (the standard setting):** Starts charging as soon as the vehicle is docked for charging
- **Delayed charging:** This is especially useful for when cheaper electric rates are desired, e.g. charging at night. Simply enter a charging start time

Please note, EV range assumes that vehicle has been pre-conditioned prior to journey. This function can be accessed either via MyVauxhall App (standard with all Combo Life Electric models or with optional Navi Pro).

Charging		
Supply	Socket	Charge Time (0 - 100%)
AC current - Domestic 3 pin socket (2.3kW)	Type 2	22h 30m
AC current - Home wallbox or public charger (7kW)	Type 2	6h 43m
AC current - Public charger (11kW)**	Type 2	4h 50m
DC current - Rapid charger (100kW)	CCS	38m (0 - 80%)

Battery	
Battery capacity	50kWh
AC on-board charger speed (standard)	7.4kW
WLTP Range (Combined)	TBC
WLTP Range (City)	TBC
Energy consumption (Combined low/high)	TBC
Battery warranty	8 years/100,000 miles/70% capacity



The Combo Life Electric is a battery electric vehicle requiring mains electricity for charging. Range data given has been determined according to WLTP test procedure methodology. The figures shown are intended for comparability purposes only and should only be compared to other cars tested to the same technical standard. The range you achieve under real world driving conditions will depend upon a number of factors, including but not limited to: the accessories fitted (pre and post registration); charging frequency; personal driving style; vehicle load and route characteristics; variations in weather; heating/air conditioning; pre-conditioning and battery condition. For more information, contact your local Vauxhall Retailer.

*Provisional data. **Requires optional 11kW on board charger.

Combo Life Specifications

Transmission

Six-speed manual gearbox
1.5 (100PS) Turbo D models

Eight-speed automatic transmission

1.5 (130PS) Turbo D models

Replacing the traditional lever, the automatic transmission selection-mode dial/drive wheel is an innovation solution that is both elegant and intuitive. By simply twisting the dial, the following modes can be selected:

- Park, for when the vehicle is stationary and the wheels are locked
- Drive, for automatic forward motion
- Neutral, for when the vehicle is stationary, wheels are free
- Reverse, for automatic backward motion

Fuel tank capacity

– 50 Litres (10.9 gallons) – Diesel models

AdBlue® Tank Capacity

– 17 Litres (3.7 gallons)

Steering

Turning circle (kerb-to-kerb)

- 11.0m (36 ft) Life models
- 11.8m (38.7 ft) Life XL models

Weights and Towing Data kg

	Gross vehicle weight	Maximum towing weights Trailer with brakes (without brakes)
5-seat		
1.5 (100PS) Turbo D	2095	1300 (750)
1.5 (130PS) Turbo D automatic	tba	tba
XL 7-seat		
1.5 (100PS) Turbo D	2285	1100 (750)
1.5 (130PS) Turbo D automatic	tba	tba

<No intersecting link>

Please note: Gross vehicle weight is the total permissible weight of the vehicle including passengers and their luggage. The maximum roof rack loading should not exceed 100kg on all models. The maximum towing weights are based on the ability of the car, with two occupants of 75kg each, to restart on a 12% gradient, which is approximately 1 in 8.3, at sea level. The permitted trailer load applies up to the specified incline and up to an altitude of 1000 metres above sea level. The permissible gross train weight decreases by 10% for every 1000 metres of additional altitude. Any extra weight, such as luggage or additional passengers, should be deducted from the maximum towing weight. Always fit Vauxhall towing attachments and accessories available from your Vauxhall Retailer. They are designed specifically for Vauxhall models and carry a 12-month guarantee. During trailer towing do not exceed a maximum speed of 60mph. This speed limit is also applicable in countries with higher permitted speeds for trailer-vehicle combinations. Pay attention to the local speed limits. For trailers with low driving stability and caravans the use of an oscillation damper is strongly recommended.

Combo Life Electric Dimensions and Capacities

All measurements in mm (inches) unless stated otherwise.

Loadspace Dimensions	5-seat	XL 7-seat
Maximum load floor length – passenger seat folded	2700 (106.3)	3050 (120.1)
Maximum load length – behind front seats	1880 (74.0)	2230 (87.8)
Maximum load length – behind second-row seats	914 (36.0)	1350 (53.1)
Maximum load length – behind third-row seats	236 (9.3)	418 (16.5) – 566 (22.3)
Maximum load height	1200 (47.2)	1119 (44.0)
Maximum load width	1195 (47.0)	1195 (47.0)
Maximum width between wheel arches	1149 (45.2)	1129 (44.4)
Loading height	584 (23.0)	620 (24.4)
Maximum tailgate aperture width	1087 (42.8) – 1241 (48.9)	1087 (42.8) – 1241 (48.9)
Maximum tailgate aperture height	1126 (44.3)	1126 (44.3)
Maximum height under raised tailgate	1892 (74.5)	1892 (74.5)
Maximum side-access aperture width	640 (25.2) – 745 (29.3)	640 (25.2) – 745 (29.3)
Maximum side-access aperture height	1145 (45.1)	1145 (45.1)
Luggage Capacities* – Litres (cu.ft.)		
Behind front-row seats to glassline	1414 (49.9)	1672 (59.0)
Behind front-row seats to roof	2126 (75.1)	2693 (95.1)
Behind second-row seats to glassline	597 (21.1)	850 (30.0)
Behind second-row seats to roof	983 (34.7)	1538 (54.3)
Behind third-row seats	571 (20.2)	806 (28.5)

*Measured using the ECIE method.

5-seat

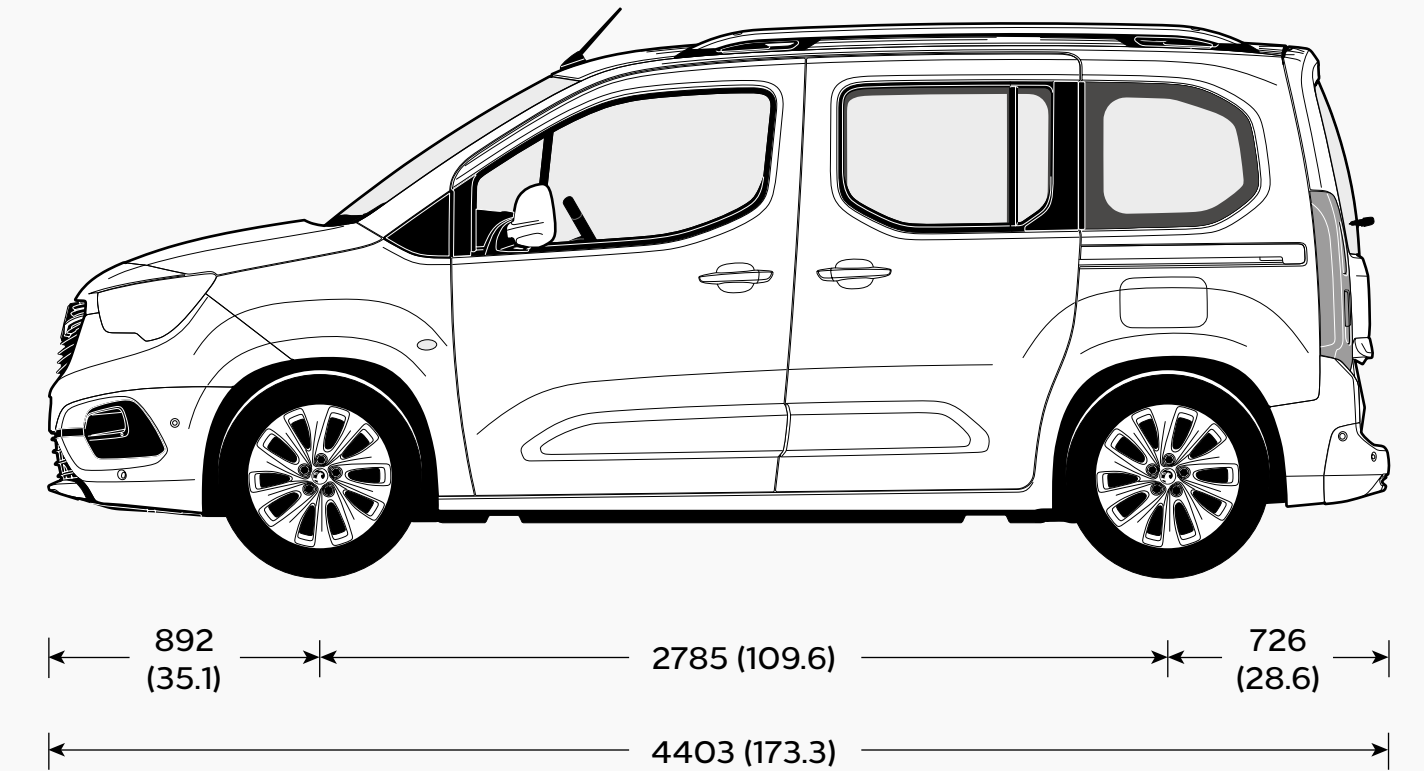
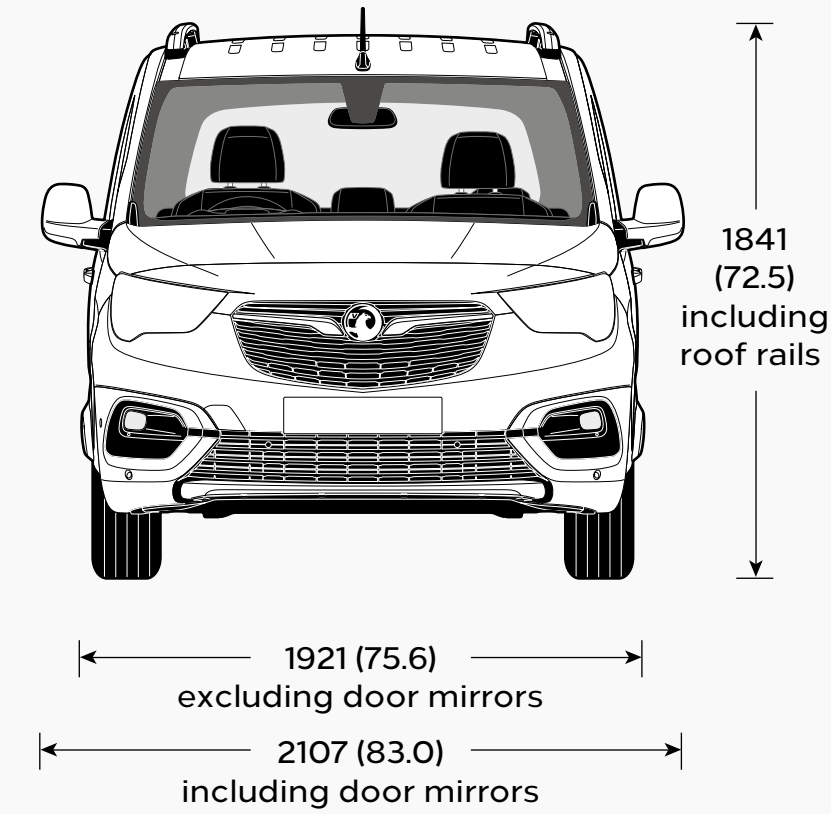

XL 7-seat

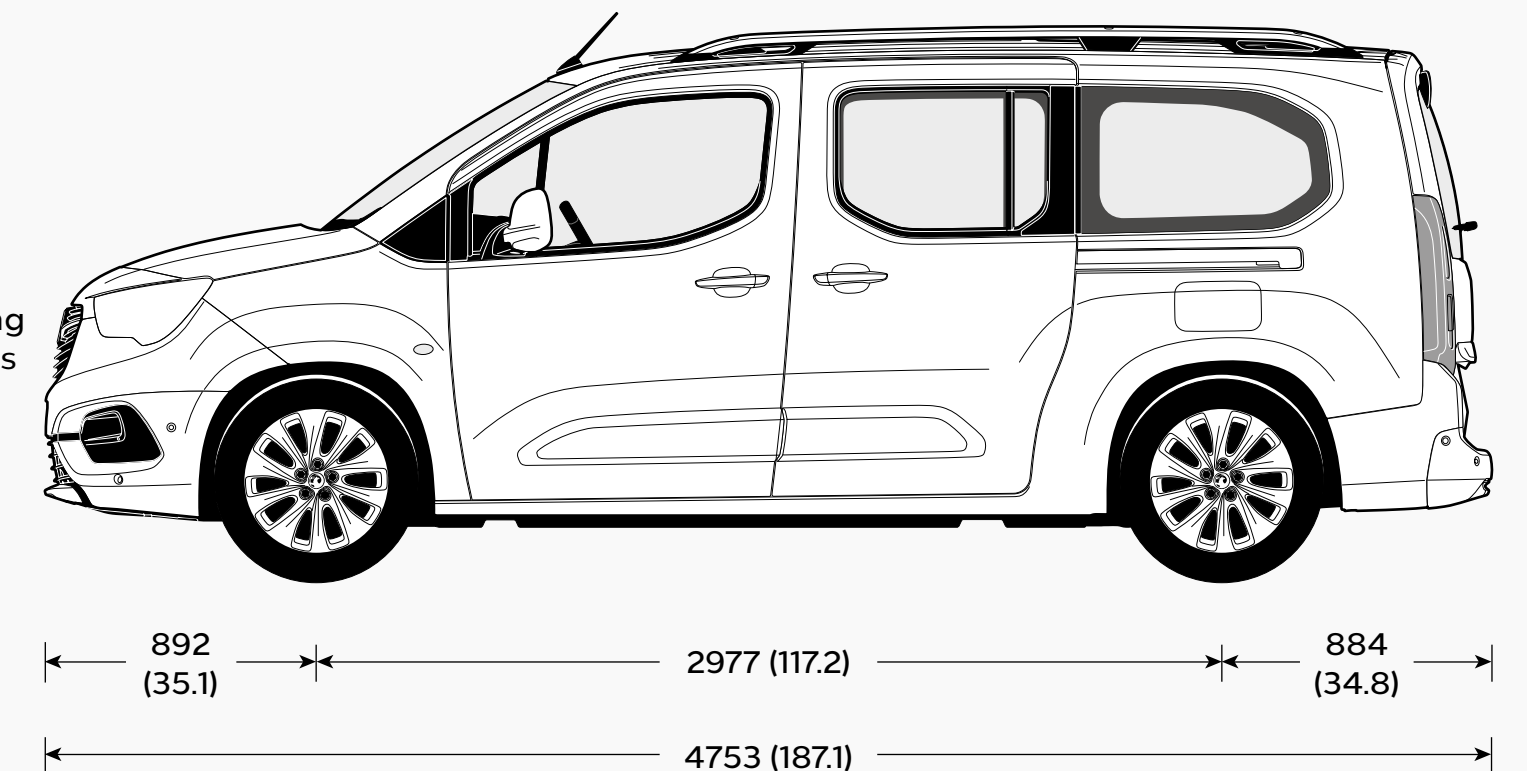
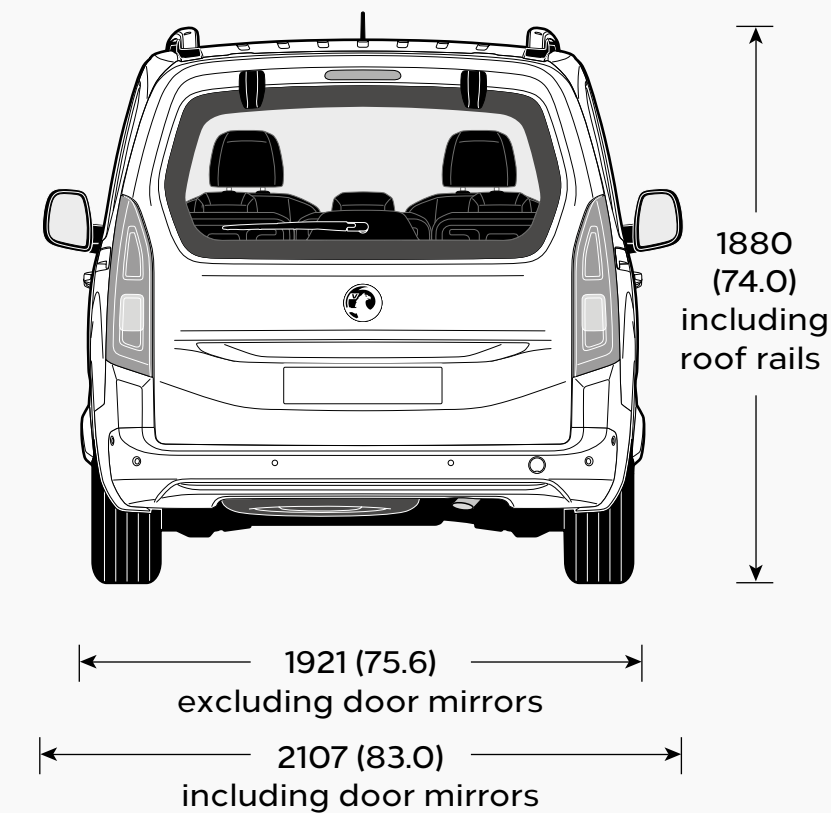

Accessories

Safety	Total (inc. VAT)	Protection	Total (inc. VAT)	Transport solutions	Total (inc. VAT)	Electric	Total (inc. VAT)
Spare wheel kit with 16-inch emergency wheel, tool kit and mounting basket	£247	Carpet mats (set of 4)	£61	Roof base carrier (set of 2 bars)		Mode 2 emergency charging cable (Type G – UK domestic plug)	£584
Philips ADR620 dash cam	£109	Carpet mats for third row seats (set of 2)	£25	– Without roof rails ²	£180	Mode 3 charging cable	
Front parking sensors	£474	Rubber mats (set of 4)	£48	– With roof rails	£219	– 7.4kW	£331
Rear parking sensors	£455	Boot tray	£64	Additional roof base carrier (1 bar)		– 11kW	£371
Child seats ¹		Vertical cargo net	£21	– Without roof rails ²	£105	– 22kW	£438
– Group 0 (0-13kg) – Britax Romer Baby Safe	£239	Dog guard – without sunroof	£282	Roof carriers (requires base carrier)		Cable bag	£49
– ISOFIX Base, Rear-facing for Britax Romer Baby Safe	£251	Dog guard – with sunroof	£248	Roof box – Thule Ocean 80	£164	Mode 2 universal charger UK kit (22kW)	£1,555
– Group 2/3 (15-36kg) – Britax Romer KIDFIX 2 R	£317	Rear splash guards	£97	Roof box – Thule Ocean 200	£374	Accessories for universal charger	
– Group 2/3 (15-36kg) – Britax Romer KIDFIX XP	£352	Comfort		Roof box – Thule Touring 200	£428	– Wall bracket	£105
– Group 3 (22-36kg) – Booster Seat without Seatback	£76	USB charger – 2 front and 2 rear ports	£28	Roof box – Thule Touring 700	£492	– Bag	£65
Safety Pack – first aid kit, hi-vis vest and warning triangle	£16	FlexConnect bracket	£33	Roof box – Thule Motion 800	from £426	– Safety lock	£20
Warning triangle	£9	FlexConnect hook	£37	Bike carrier – Thule FreeRide 532	£81	– Adapter Type 2	£318
Hi-vis safety vest – adult	£4	FlexConnect coat hanger	£41	Bike carrier – Thule Expert 298	£134	– Adapter Type 3c	£358
Hi-vis safety vest – child 3-6 years (42cm)	£4	FlexConnect folding table	£102	Surfboard carrier – Thule 833	£84	– Adapter (various)	£120
Hi-vis safety vest – child 7-12 years (52cm)	£4	FlexConnect iPad Mini holder	£127	Kayak carrier – Thule Hull-a-Port Pro 837	£234		
First aid kit	£15	FlexConnect iPad holder	£106	Ski/snowboard carrier			
Emergency seat belt cutter and hammer	£19	FlexConnect iPad Air holder	£106	– Thule Snow Pack 7324 (4 x pairs)	£147		
Fire extinguisher (1kg) with strap	£23	FlexConnect Samsung Galaxy 10.1 holder	£127	Ski/snowboard carrier			
Spare bulb kit – 11 x high-quality bulbs and 7 x fuses from Philips	£70	FlexConnect Samsung Galaxy 10.1 holder	£127	– Thule Snow Pack 7326 (6 x pairs)	£265		
		Privacy shades (set of 2) for:		Towing			
		– side rear windows (tilt/turn window)	£59	Swan's neck towing ball and			
		– side rear windows (electric window)	£59	13-track wiring loom			
		– quarter side rear windows (Life models)	£57	– Life models	£463		
		– quarter side rear windows (Life XL models)	£60	– Life XL models	£463		
		– rear window	£60	Tow bar with removable tow ball and			
		Cupholder organisers	£8-10	13-track wiring loom			
		Smoker's kit	£20	– Life models	£571		
		Fragrance diffuser	£24	– Life XL models	£567		
		Fragrance cartridge (various)	£18	13-pin to 7-pin adaptor	£30		

Please note: Prices shown are fully fitted and painted, where applicable and include VAT. Please check with your local Vauxhall Retailer for details. It is advisable to ensure your insurance policy is adequate to cover additional fitted accessories. Prices correct at time of publication.

¹Restrictions apply to the use of child seats, please consult your vehicle user manual or Vauxhall Retailer. ²A dedicated T-Track adapter (Thule 697-4 or Thule 697-6) is required for the installation of specific roof boxes, contact your local Vauxhall Retailer for details.

Company Car Driver and Fleet Information

Benefit in kind company car taxation*

The car benefit charge will be the car's list price (including VAT, options and accessories fitted, delivery to Retailer and number plates, but excluding Vehicle Excise Duty and new vehicle first registration fee) multiplied by the percentage charge for the CO₂ emissions band in which the car falls (see table opposite). Multiply this figure by your personal income tax rate (20%** for Basic Rate, 40%** for Higher Rate) to calculate your annual benefit in kind tax liability.

Generic example:

ELECTRIC vehicle: 0g/km CO₂

On-the-road RRP	£27,305.00
Deduct: Vehicle Excise Duty	£0.00
New vehicle first registration fee	-£55.00
Effective list price	£27,250.00
Add: Optional two-coat metallic paint	£600.00
List price for tax purposes (P11D value)	£27,850.00
Car benefit charge 2023 – 24 tax year (2%)	£557.00
Benefit in kind tax liability	
Basic Rate (20%) tax payer	£111.40
Higher Rate (40%) tax payer	£222.80

*Please note this Price Guide provides taxation information as a guide only. Vauxhall does not provide taxation guidance. Drivers should always take professional advice on their own tax position.

**Excludes residents of Scotland.

BiK for Scottish Residents

Effective 6 April 2018 the Scottish Government have introduced their own BiK taxation structure. This only applies to Company Car Drivers that are Scottish taxpayers. HMRC will determine whether or not an individual is a Scottish taxpayer based on where their main place of residence is.

The BiK rates for Scotland are:

- Over £12,570 – £14,732 Starter Rate 19%
- Over £14,732 – £25,688 Basic Rate 20%
- Over £25,688 – £43,662 Intermediate Rate 21%
- Over £43,662 – £150,000 Higher Rate 41%
- Above £150,000 Top Rate 46%

CO ₂ emissions (g/km)	Electric range (miles)	Percentage of cars price to be taxed 2023 – 24 tax year
0	-	2%
1 – 50	130+	2%
1 – 50	70 – 129	5%
1 – 50	40 – 69	8%
1 – 50	30 – 39	12%
1 – 50	<30	14%

To calculate your own personal liability, search: **Vauxhall BiK**, or click the link below:

[Vauxhall BiK Tool](#)

Fleet Toolbox

Discover the facts in our online Toolbox for both Company Car Drivers and Fleet Decision Makers. The Fleet Toolbox has a host of useful calculators, comparators, interactive listings and information.

Search Vauxhall Fleet Tools or click the link below:

[Vauxhall Fleet Tool Box](#)

Contact Vauxhall Fleet

Please contact one of our dedicated sales teams who will be happy to help with your particular enquiry.

Fleet Decision Makers

Depending on the size of your fleet of vehicles, we have a dedicated team to handle your enquiries. The lines are open Monday to Friday excluding Bank Holidays.

1 – 24 vehicles

Call: 0203 885 4560 (8:30am – 5:00pm)

Email: enquiries@stellantis-fleet.co.uk

50+ vehicles

Call: 0203 885 4562 (8:30am – 5:00pm)

Email: enquiries@vauxhallfleet.co.uk

Special Vehicles (Police, Fire and Ambulance)

Call: 01582 409999

Email: psvo@stellantis.com

Further Information

On-the-road prices

To eliminate uncertainty about hidden costs when buying a new car, Vauxhall publishes on-the-road recommended retail prices (RRP) and these are shown in the pricing tables within this price guide. These prices include VAT, number plates and delivery to Retailer of £900.00 (including £150.00 VAT), 12 months' Government Vehicle Excise Duty (see opposite for details) and the DVLA new vehicle first registration fee of £55.00.*

Please note: The on-the-road recommended retail price (RRP) does not include fuel supplied by the Retailer, motor insurance or any other goods or services supplied by agreement between the Retailer and the customer.

Price protection

Order a new Vauxhall for build in the current model year (as confirmed by your Retailer) for delivery no more than three months in advance and the price you are quoted is the price you pay. This is irrespective of any subsequent price rises between placing your order and delivery of your new car, but you must take delivery as soon as the car is available.

Please note: Vauxhall Motors Limited is not liable for price adjustments caused by Government changes in the rate of VAT (currently 20%), Vehicle Excise Duty, DVLA new vehicle first registration fee or by any other applicable legislation or regulations.

In the event of an accident

Vauxhall Accident Management helps keep you mobile following an accident. Benefits include vehicle recovery, Vauxhall-approved repairs and contacting your insurer. For more details, visit vauxhall.co.uk/AccidentManagement

LEASYS

Leasys UK

Leasys is the proud Business Contract Hire partner of Vauxhall and consequently, can provide quick vehicle delivery to keep your business mobile.

Specialised in Medium to Long-Term Leasing options and Fleet Management solutions for businesses of all sizes, [Leasys](#) lead mobility by offering sustainable and innovative solutions designed around customers, for a best-in-class experience. Their team of experts can personally support you and provide dedicated consultation.

[Leasys](#) is equally owned by Stellantis and Crédit Agricole Consumer Finance and is a member of the British Vehicle Rental and Leasing Association (BVRLA).

For further information, please contact your local Vauxhall Retailer or visit leasys.com/uk

Vehicle Excise Duty

The amount of Vehicle Excise Duty (road fund licence) payable on new cars varies depending on the level of carbon dioxide (CO₂) emissions produced by the vehicle. CO₂ emissions are measured in grams per kilometre (g/km) travelled and divided into 13 charging bands shown in the table opposite.

A 'first year rate' of Vehicle Excise Duty is payable on all new cars and in subsequent years the amount payable reverts to the 'standard rate'. Also, for vehicles with a list price over £40,000, including factory-fitted options, an additional £390 is payable for the first five years of standard rate payments.

Vehicle Excise Duty*

Band	CO ₂ emissions in grams per kilometre	First year rate Diesel	Standard rate Diesel	Standard rate Electric
A	0	£0	£0	£0
B	1 – 50	£10	£180	–
C	51 – 75	£30	£180	–
D	76 – 90	£130	£180	–
E	91 – 100	£165	£180	–
F	101 – 110	£185	£180	–
G	111 – 130	£210	£180	–
H	131 – 150	£255	£180	–
I	151 – 170	£645	£180	–
J	171 – 190	£1,040	£180	–
K	191 – 225	£1,565	£180	–
L	226 – 255	£2,220	£180	–
M	Over 255	£2,605	£180	–

*Correct at time of issue.

Further Information

Customer Care Commitment

For added peace of mind, Vauxhall has an innovative Customer Care Commitment that offers the following:

- Three-year vehicle warranty consisting of a one-year/unlimited mileage manufacturer's warranty and a second and third year manufacturer's warranty with a 60,000 miles limitation
- Vauxhall Assistance for 12 months from first registration
- Six years' body panel anti-perforation warranty

Please note: Warranty is only available on vehicles sourced from Vauxhall Motors Limited. Terms and conditions apply – please see your Vauxhall Retailer for details.

Vauxhall Assistance

Vauxhall Assistance is provided automatically with every new Vauxhall for 12 months from first registration and covers everything from accident assistance, roadside recovery and 'at home' service to flat tyres. For even more peace of mind, on fully electric models, the cover is extended* to 3 years. Even more reason for you to stay calm and let us take care of everything should the need arise. With Vauxhall Assistance help is literally just a free** phone call away, 24 hours a day, 365 days a year!

Protecting the environment

Vauxhall's commitment to the environment is demonstrated by our products' many environmental awards. For even more information on Vauxhall's efforts to achieve an environmentally sustainable future, and how to dispose of your end-of-life vehicle, see vauxhall.co.uk/recycling

Vauxhall Care

This all-inclusive service package is available on Vauxhalls under 10 months old (from date of first registration).

This package offers complete peace of mind for the first 3 years of your Vauxhall's life with fixed monthly payments for the plan duration.

- **3 years' Vauxhall servicing** – covers first, second and third annual services. Including a brake-fluid change in the second service
- **2 years' Vauxhall Roadside Assistance** – first year from us
- **First years' MOT[†]** – free of charge by your local Vauxhall Retailer

For full terms and conditions and to sign up, visit: vauxhall.co.uk/vauxhallcare

Vauxhall Service Club

Vauxhall Service Club is available for all Vauxhall owners, and it's free to join. Members benefit from the following:

- 15% off Vauxhall Approved Accessories
- Vauxhall's aged 2-3 Years = 15% off parts and labour
- Vauxhall's aged over 3 Years = 25% off parts and labour
- Half price MOT's (NI excluded)
- Free pre-MOT test inspection (NI only)
- Fixed price AdBlue[®] Refills
 - Car = £14.99
 - Van = £24.99
- Access to the Vauxhall Accident Management Programme
- Online service booking available 24/7 with servicing appointments available within 3 days – [Book Online](#)
- Collection and delivery/onward mobility options
- Complimentary 'Wash and Vac' with all routine services^{††}
- Vauxhall trained technicians
- Genuine Vauxhall parts
- Minimum 12 months warranty on parts and labour
- Regular newsletters with exclusive offers, discounts and competitions

Terms and conditions apply. To join visit: vauxhall.co.uk/serviceclub

Vauxhall Insurance with added reassurance

Comprehensive cover – Summary of benefits

- Competitive premiums
- Repairs by a Vauxhall-trained technician
- Genuine Vauxhall parts, guaranteed for five years when we repair your car within our Approved Repairer Network
- Free courtesy car as standard when using an Approved Repairer[‡]
- 24 hour claims helpline
- Personal Accident benefit
- Cover for audio equipment
- Windscreen cover

Call for a quote on 0330 678 1130^{‡‡}

For more product information

For further information on the Vauxhall range or location of your nearest Vauxhall Retailer please call 0800 026 0034. Alternatively, details can be found on our website at vauxhall.co.uk

For more information call **0800 026 0034**

For Fleet enquiries call **0203 476 2268**

Discover the full Vauxhall range at **[vauxhall.co.uk](https://www.vauxhall.co.uk)**

Join us online

The invoice price, including delivery to Retailer, factory-fitted options, accessories fitted by the Retailer and number plates, is subject to VAT. Some feature descriptions in this guide may refer to, and some illustrations may show, optional equipment not included in the standard delivery. The information contained in this guide was accurate at the time of publication. We reserve the right to make changes in design and equipment. Please note that Vauxhall Retailers are not the agents of Vauxhall Motors Limited and are not authorised to bind Vauxhall Motors Limited by any specific or implied undertaking or representation. It is advisable to ensure that your motor insurance policy provides adequate cover for additional fitted options and accessories. The colours in this guide are only approximate actual colours. Illustrated optional equipment is available at extra charge. Availability, technical features and equipment provided on our vehicles can vary by model. For precise information on the equipment provided on our vehicles, please contact your local Vauxhall Retailer.

Price and Specification Guide
11 March 2024 | Model Year 2024A (J0)



New Vivaro Life

All Electric Range

Effective 11 March 2024

New Vivaro Life Electric Model Year 2024A

Contents

To find the information you want use the links below to navigate around the guide:

[Choose Your Trim Level](#)

[Range Highlights](#)

[Models](#)

[Prices](#)

[Features/Options](#)

[Infotainment](#)

[Interior Style and Comfort](#)

[Exterior Colours](#)

[Wheels and Tyres](#)

[Specifications](#)

[Dimensions and Capacities](#)

[Accessories](#)

[Company Car Information](#)

[Further Information](#)

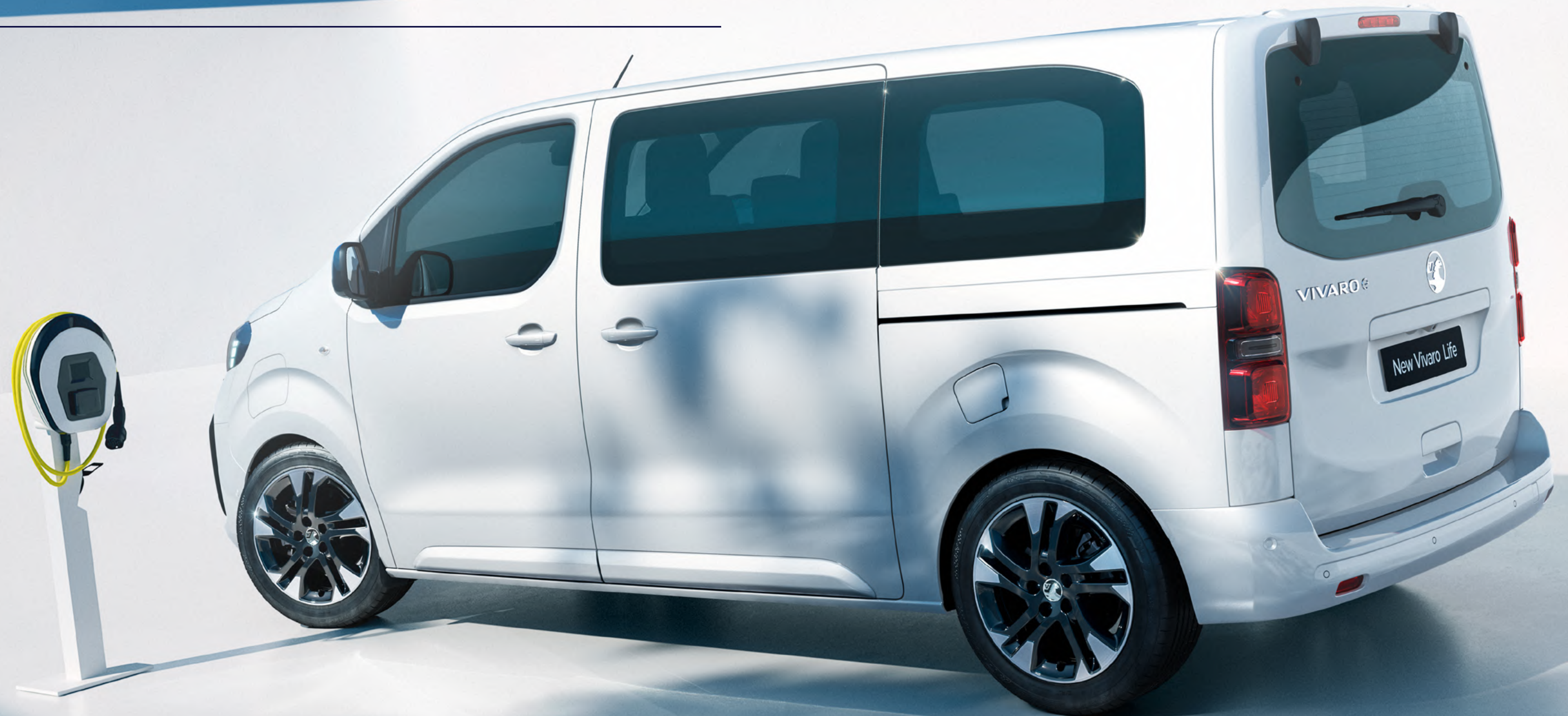

Choose Your Trim Level

Combi



VX_VIVL_e_33964.psd

With added versatility the Combi comes standard with numerous comfort and safety features to make it the perfect transportation vehicle to get the job done. It comes complete with a 10 inch HD touchscreen with wireless mirror screen and 4G connectivity.

Design



VX_VIVL_e_34093.psd

The Design is packed with practical features as standard to provide ample, comfortable and safe accommodation for all the family. It has 60/40 split bench seats and the third-row three-passenger bench seat is foldable for added flexibility. The door mirrors are electrically adjustable and heated and rear parking distance sensors help make for safer driving.

Ultimate



VX_VIVL_e_34094.psd

Ultimate is the most premium model of the Vivaro range. With keyless entry and start, Vauxhall Connect and a sophisticated HiFi pack, and top of the range tech, the Ultimate is specifically designed for luxurious comfortable travel.

New Vivaro Life Electric Range Highlights

Combi

Standard features include:

- Multimedia Pro
 - 10-inch HD touchscreen with wireless mirror screen
 - AM/FM/DAB digital radio
 - 4G connectivity
 - Voice control
 - USB connection
 - Two speakers and two tweeters
 - Vauxhall Connect
 - 16-inch steel wheels
 - Air conditioning
 - Electronic parking brake
 - Dual front passengers' seat with underseat storage
 - Second-row three-passenger 60/40 split bench seat with tilt function
 - Third-row three-passenger fixed bench seat
 - Electrically operated front windows
 - Nearside and offside sliding side-access doors with fixed windows
 - Tailgate with wash/wipe and heated rear window
 - Tyre pressure monitoring system
 - Remote control central deadlocking
 - Selective door locking
 - Electronic engine deadlock immobiliser
 - 10-inch colour digital instrument cluster
 - High Beam Assist
 - Automatic on/off headlight control
 - Rain-sensitive windscreen wipers
 - Intelligent Speed Assistance
 - Lane Keeping Assist
 - Advance Emergency Braking System
- Driver Attention Alert
 - Rear parking distance sensors
 - Paddles for regenerative braking selection.
 - Three levels – light; medium; strong

Design

Features over Combi models:

- Tinted privacy rear windows and tailgate
- Individual driver and passenger seats
- 60/40 split bench seat in second- and third-rows
- Electrically adjustable/heated door mirrors
- 17-inch steel wheels with full diameter trims
- Front fog lights
- Front and rear body-coloured bumpers
- Body-colour side protection mouldings
- Curtain airbags in second- and third-rows
- Mistral black Side Trim panels with Decorative Inserts
- Premium Roof trim (Woven)
- Acoustic pack (motor and cabin noise absorbers)
- Illuminated sunvisors and retractable handles
- Eco LED Headlamps with integrated DRL

Ultimate

Features over Design models:

- Connected Navigation
 - 10-inch HD touchscreen with wireless mirror screen
 - AM/FM/DAB digital radio
 - 4G connectivity
 - Voice control
 - USB connection
- HiFi Pack including amplifier – TOSCA premium speakers (includes four in row 1; four in row 2, central loudspeaker on dashboard and subwoofer)
- 17-inch bi-colour alloy wheels
- Electrically operated sliding side-access doors
- Leather seat trim
- Heated power driver's seat and heated front passenger's seat with massage facility
- Dual-zone electronic climate control with rear air conditioning
- Roof-mounted rear heater controls
- Rear parcel shelf
- Third-row three-passenger foldable 60/40 split individually sliding bench/single seat
- Rear seat back tables
- Front & Rear Park Assist
 - Visiopark 180
 - Blind spot detection
- Thick Floor carpet
- Heated Leather Steering Wheel
- Keyless Entry & Starting
- Automatic anti-dazzle rear view mirror

New Vivaro Life Electric Combi



**Combi
(Medium) 9-seater** **OTR from
£39,190.60**

Infotainment:

- Multimedia Pro
 - 10-inch HD touchscreen with wireless mirror screen
 - AM/FM/DAB digital radio
 - 4G connectivity
 - Voice control
 - Two speakers and two tweeters
- Vauxhall Connect

Interior convenience/styling:

- Air conditioning
- Multi-function trip computer
- Electronic parking brake
- Dual front passengers' seat with underseat storage
- Second-row three-passenger 60/40 split bench seat with tilt function
- Third-row three-passenger fixed bench seat

Exterior convenience/styling:

- 16-inch steel wheels
- Electrically operated front windows
- Nearside and offside sliding side-access doors with fixed windows
- Tailgate with wash/wipe and heated rear window
- Side-protection mouldings

Safety/security:

- Six airbags
- Height-adjustable lap and diagonal inertia-reel seatbelts
- Electronic stability programme with traction control
- Anti-lock braking system
- Tyre pressure monitoring system
- Hill start assist
- Remote control central deadlocking
- Selective door locking
- Electronic engine deadlock immobiliser
- 10-inch colour digital instrument cluster
- High Beam Assist
- Automatic on/off headlight control
- Rain-sensitive windscreen wipers
- Intelligent Speed Assistance
- Lane Keeping Assist
- Advance Emergency Braking System
- Driver Attention Alert
- Rear parking distance sensors
- Paddles for regenerative braking selection.
 - Three levels - light; medium; strong

**XL Combi
(Long) 9-seater** **OTR from
£44,590.60**

New Vivaro Life Electric Design



VX_VIVL_e_34093.psd

Design (Medium) 8-seater **OTR from £50,194.60**

Infotainment:

- Multimedia Pro
 - 10-inch HD touchscreen with wireless mirror screen
 - AM/FM/DAB digital radio
 - 4G connectivity
 - Voice control
 - Two speakers and two tweeters
- Vauxhall Connect

Interior convenience/styling:

- Air conditioning
- Multi-function trip computer
- 60/40 split bench seat in second- and third-row
- Third-row three-passenger foldable bench seat
- Grey fabric Curitiba trim
- Individual driver and front passenger seat
- Electronic parking brake
- Rear seat back tables

Exterior convenience/styling:

- 17-inch steel wheels with full-diameter trims
- Electrically adjustable/heated/foldable door mirrors
- Electrically operated front windows
- Tailgate with wash/wipe and heated rear window
- Body-colour side-protection mouldings
- Body-colour front and rear bumpers
- Body-colour rear corner bumper with black centre section (Long vehicle only)
- Front fog lights
- Tinted rear windows
- Rear parking distance sensors

Safety/security:

- Ten airbags
- Height-adjustable lap and diagonal inertia-reel seatbelts
- Electronic stability programme with traction control
- Anti-lock braking system
- Tyre pressure monitoring system
- Hill start assist
- Selective door locking
- Electronic engine deadlock immobiliser
- Mistral black Side Trim panels with Decorative Inserts
- Premium Roof trim (Woven)
- Acoustic pack (motor and cabin noise absorbers)
- Illuminated sunvisors and retractable handles
- Eco LED Headlamps with integrated DRL
- 10-inch colour digital instrument cluster
- High Beam Assist
- Automatic on/off headlight control
- Rain-sensitive windscreen wipers
- Intelligent Speed Assistance
- Lane Keeping Assist
- Advance Emergency Braking System
- Driver Attention Alert
- Rear parking distance sensors
- Paddles for regenerative braking selection.
 - Three levels - light; medium; strong

XL Design (Long) 8-seater **OTR from £51,094.60**

New Vivaro Life Electric Ultimate



Vauxhall EMZ23EVX1FCWH1N1X8A10FT5.jpg

Ultimate (Medium) 8-seater OTR from **£55,430.20**

Infotainment:

- Connected Navigation
 - 10-inch HD touchscreen with wireless mirror screen
 - AM/FM/DAB digital radio
 - 4G connectivity
 - Voice control
 - USB connection
- HiFi Pack including amplifier – TOSCA premium speakers (includes four in row 1; four in row 2, central loudspeaker on dashboard and subwoofer)
- Vauxhall Connect

Interior convenience/styling:

- Dual-zone electronic climate control with rear air conditioning
- Multi-function trip computer
- Second-row three-passenger foldable 60/40 split bench seat
- Third-row three-passenger foldable 60/40 split individually sliding bench/single seat
- Leather seat trim
- Heated Leather Steering Wheel
- Heated power driver's seat and heated front passenger's seat with massage facility
- Driver's seat memory functions
- Roof-mounted rear heater controls
- Electronic parking brake
- Rear parcel shelf
- Rear seat back tables
- Rear side window blinds
- Automatic anti-dazzle rear-view mirror

Exterior convenience/styling:

- 17-inch bi-colour alloy wheels
- Visibility Pack
- Electrically adjustable/heated/foldable door mirrors
- Tailgate with wash/wipe and heated opening rear window

- Electrically operated front windows
- Body-colour side-protection mouldings
- Electrically operated sliding side-access doors
- Body-colour front and rear bumper
- Body-colour rear corner bumper with black centre section (Long vehicles only)
- Front fog lights
- Front & Rear Park Assist
 - Visiopark 180 - Blind spot detection
- Dark-tinted rear windows
- Front & Rear parking distance sensors
- Keyless entry and start

Safety/security:

- Driver Assistance Pack
- Ten airbags
- Height-adjustable lap and diagonal inertia-reel seatbelts
- Electronic stability programme with traction control
- Anti-lock braking system
- Tyre pressure monitoring system
- Hill start assist
- LED daytime running lights
- Selective door locking
- Electronic engine deadlock immobiliser
- 10-inch colour digital instrument cluster
- High Beam Assist
- Automatic on/off headlight control
- Rain-sensitive windscreen wipers
- Intelligent Speed Assistance
- Lane Keeping Assist
- Advance Emergency Braking System
- Driver Attention Alert level-3
- Rear parking distance sensors
- Paddles for regenerative braking selection.
 - Three levels – light; medium; strong

XL Ultimate (Long) 8-seater OTR from **£56,330.20**

Effective 11 March 2024

New Vivaro Life Electric Model Year 2024A

New Vivaro Life Electric Prices

	LCDV Code	Price (£)	VAT (£)	Total (£)	On-the-road RRP (£)	P11D Value (£)	2023/24 BIK %	WLTP Combined CO ₂ (g/km) - LCDV Code	Insurance Groups
Combi									
(136PS) auto – 50kWh battery	1GKONNLZEFTOAOJO	31,863.00	6373	38,235.60	39,190.60	39,135.60	2%	0	tba
(136PS) auto – 75kWh battery	1GKONNLETFTOAOJO	36,363.00	7423	43,635.60	44,590.60	44,535.60	2%	0	tba
XL Combi									
(136PS) auto – 50kWh battery	1GKONPLZEFTOAOJO	32,613.00	7273	39,135.60	40,090.60	40,035.60	2%	0	tba
(136PS) auto – 75kWh battery	1GKONPLETFTOAOJO	37,113.00	6523	44,535.60	45,490.60	45,435.60	2%	0	tba
Design									
(136PS) auto – 75kWh battery	1GKONNQETFTOAOJO	41,033.00	8207	49,239.60	50,194.60	50,139.60	2%	0	tba
XL Design									
(136PS) auto – 75kWh battery	1GKONPQETFTOAOJO	41,783.00	8357	50,139.60	51,094.60	51,039.60	2%	0	tba
Ultimate									
(136PS) auto – 75kWh battery	1GKONNSETFTOAOJO	45,396.00	9079	54,475.20	55,430.20	55,375.20	2%	0	tba
XL Ultimate									
(136PS) auto – 75kWh battery	1GKONPSETFTOAOJO	46,146.00	9229	55,375.20	56,330.20	56,275.20	2%	0	tba

WLTP Combined CO₂ (g/km) figures are based on a configured vehicle as per LCDV code for UK with no options fitted.

Please note: On-the-road recommended retail prices (RRP) include number plates and delivery to Retailer of £900.00 (including £150.00 VAT), 12 months' Vehicle Excise Duty and new vehicle first registration fee of £55.00. Excludes fuel and insurance. Company Car Benefit in Kind (BiK) rates are monthly based on the standard paint price. Price has been calculated using manufacturer estimates. Retailers may be required to carry out more than one credit check during the course of the order process. You may be required to place a deposit when placing your order with your supplying Retailer. In the event of a price change, deposit refunds will be governed by your supplying Retailer's policy and as such must be discussed with the supplying Retailer.

Effective 11 March 2024

New Vivaro Life Electric Model Year 2024A

Features/options

Model specific features/options	Option code*	LP (£) Inc VAT	Combi	Design	Ultimate	Restrictions
Fixed tinted rear windows (70% opacity)	VG02	£320	●			
Symmetrical 50/50 swing glazed doors with heated system and wipers on each door. Opening 180° hinges, with lock on left door only.	WO05	£200	●			
Rear tailgate with opening window, with heated system and wiper	WO07	£600	●	●		
Panoramic Sunroof, and Opening Tailgate Window	OK01	£700			●	
Rear Air Conditioning with roof control panel at the roof	NR02	See note	●	●		£900 on Combi, and £600 on Design
Multimedia NAVI - IVI High: Radio AM/FM/DAB - Connected navigation - 10" HD Touch screen with Mirror Screen (WiFi) - 4G connectivity + voice control + E-call + A-call	ZJA9	See note	●	●		£900 on Combi, and £700 on Design
Handsfree & Easy Access Pack - Nearside and offside power sliding side-access doors with hands-free access with key detection and sensor under rear bumper	WZ09	£1,100		●		

Features/options

Model specific features/options	Option code*	LP (£) Inc VAT	Combi	Design	Ultimate	Restrictions
F2F Rear Seat Pack (2nd Row) - Individual VIP Leather Armchairs - Removable without tools, Isofix standard - Rail Mounted and Returnable Drop & Go - Flat folding - Storage at the back - Foldable sliding table on rails 7-Seater: 2 (Front row) + 2 (2nd Row) + 3 (3rd Row)	AL35	£750			●	
F2F Rear Seat Pack (3rd Row) - Individual VIP Leather Armchairs - Removable without tools, Isofix standard - Rail Mounted and Returnable Drop & Go - Flat folding - Storage at the back 6-Seater: 2 (Front row) + 2 (2nd Row) + 2 (3rd Row)	AN01	£740			●	Requires AL35
ACC Pack - MT: Active Cruise Control - System can reduce speed down to 18 mph - AT: Stop & Go - System can bring vehicles to complete stop - Leather Steering Wheel	ZVKT	See note		●	●	£600 on Design, and 200 on Ultimate
Driver Pack - Leather Steering Wheel - Wireless Charging - Keyless Entry & Start - Electronic climate control (dual-zone)	VH04	£800		●		
Converter Pack - Upgraded battery and alternator (L3 720 battery, class 18 alternator) - Towbar pre-conditioning (rear electric harness + fast connectors (behind rear bumper) + beam with 13 pin socket) - Conversion interface box - Only for use for electrical connections for integral elements of a vehicle conversion	BQ01	£230		●	●	

Safety features

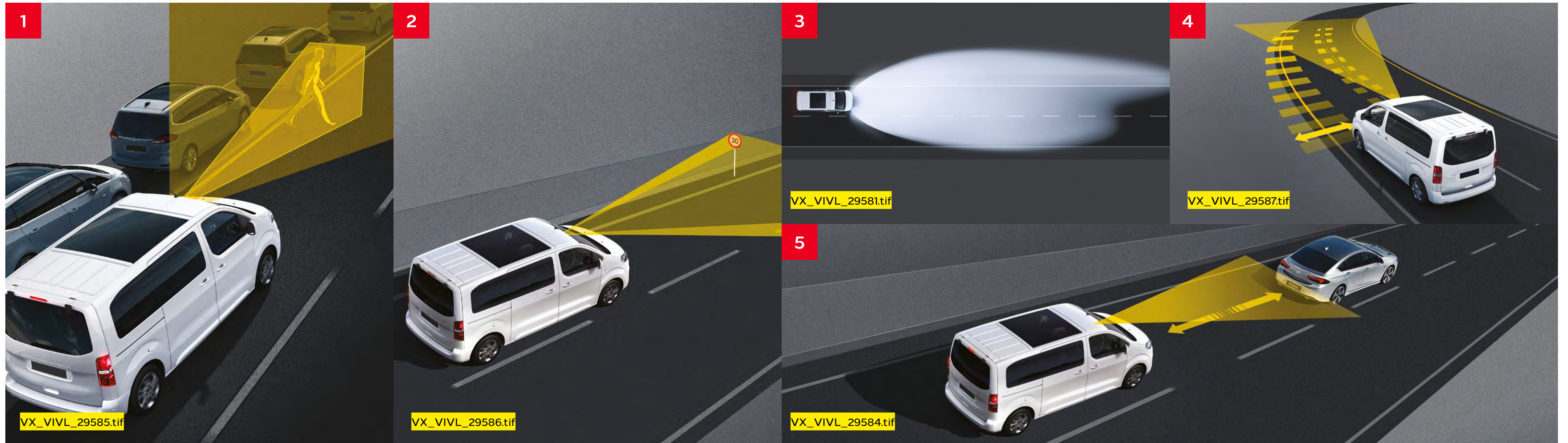

1. Dynamic surround view

Incorporates a digital rear-view mirror with cameras above the rear door and in the nearside exterior door mirror, extending the view of traditional rear view mirrors.

The system features include:

Side blind spot detection – Enables the driver to clearly see obstacles on the nearside.

Visiopark 180° rear parking camera – Working with 12 parking sensors enables safer reversing as the driver is now able to view a larger area via the digital display screen. Automatically activates when reverse gear is engaged or the rear doors are opened.

2. Intelligent speed assistance

Recognises speed limit signs and visually warns the driver of local restrictions followed by an acoustic warning if the limit is exceeded.

3. High beam assist

Switches the headlights between high beam and dipped beam automatically to avoid blinding other drivers.

4. Lane keep assist

If the driver has not actively steered or signalled, the system performs corrective steering actions to help prevent the vehicle crossing painted boundary lines or road side edges.

5. Active cruise control with stop and go facility

Maintains the speed set but if a slower vehicle is detected ahead, the system will automatically lower the vehicle speed to keep a safe distance – 19mph minimum with manual transmission. For models with automatic transmission, the system will bring the vehicle to a complete standstill if required.

Driver attention alert*

Monitors your time behind the wheel and sends a warning after two and three hours continuous driving. The system continues to analyse driving patterns via the front camera and steering wheel

movements, and then warns you when it's time to take a quick break.

Forward collision alert incorporating Advance Emergency Braking System (AEBS)*

This system alerts the driver of a potential collision through a combination of visual and then audible warnings. Should the driver fail to react, autonomous emergency braking is triggered to help mitigate/avoid the impact by reducing the speed of the vehicle. AEBS provides additional assistance to optimise braking performance while a dynamic brake support function boosts pressure to help further minimise stopping distances.

Driver Assistance

Standard Features – The following features are standard across the entire New Vivaro Life Electric range. Specific features by model are outlined in the separate tabular information.

Steering

- Speed sensitive electrically assisted power steering
- Reach and rake adjustable steering
- Cruise control

Wipers

- Two-speed windscreen wipers with variable intermittent wipe
- Intermittent rear window wash/wipe

Model Specific Features/Options

	Option code*	Combi	Design	Ultimate
Driver Assistance				
Visibility Pack – Solar heat-absorbing windscreen/Rain-sensitive windscreen wipers		●	●	●
Rear parking distance sensors**		●	●	●
Electronic parking brake		●	●	●
Automatic transmission with e-toggle shift		●	●	●
7.4kW single-phase on-board charger with 6m mode-3 7kW cable (added at POE)		●	●	●
11kW three-phase on-board charger with mode-3 22kW cable (added at POE)	LZ04	£360	£360	£360
Visio-park				●

*Optional at extra cost including VAT. **Please note, due to ongoing shortages in the global supply chain, some New Vivaro Life Electric models may be built with reduced levels of standard equipment. Please consult your supplying Retailer for further details.

Driver Information and Security

Standard Features – The following features are standard across the entire New Vivaro Life Electric range. Specific features by model are outlined in the separate tabular information.

Driver Information

Instrumentation

(see specifications for further details)

- Speedometer

Multi-function trip computer

- Trip odometer
- Vehicle range
- Average speed
- Driving time

Central fascia display

(format dependent on infotainment unit)

- Audio information
- Digital clock with automatic RDS time adjustment
- Outside air temperature with ice warning function
- Additional features dependent on infotainment unit (see infotainment for details)
- 10" Digital Cluster

Security

- Electronic engine deadlock immobiliser
- Steering column lock
- Anti-theft spare wheel cradle
- Visible Vehicle Identification Number (VIN)
- Locking wheel bolts with alloy wheels

Model Specific Feature/Option

	Option code	Combi	Design	Ultimate
Security				
Keyless entry and start				●
Remote control security alarm system	AB08	£270	£270	£270

*Optional at extra cost including VAT.

Convenience

Standard Features – The following features are standard across the entire New Vivaro Life Electric range. Specific features by model are outlined in the separate tabular information.

Interior Convenience

- Reach and rake-adjustable steering wheel
- 12v socket in saloon area
- 12v socket in cargo area

Interior Storage

- Upper glovebox
- Open lower glovebox
- Lower shelf
- Two drinks holders on top of facia
- Storage pocket in front of drive mode controls
- Front door pockets with three separate compartments

Model Specific Features

	Option code	Combi	Design	Ultimate
Interior Convenience and Storage				
Luggage area cover				●
Rear seat back tables			●	●
Rear side-window blinds				●
220 volt socket behind driver's seat			●	●
Automatic anti-dazzle rear-view mirror				●
Electrically foldable door mirrors			●	●

Convenience

Standard Features – The following features are standard across the entire New Vivaro Life Electric range. Specific features by model are outlined in the separate tabular information.

Heating and Ventilation

- Air recirculation facility
- Pollen filter
- Illuminated controls

Exterior Convenience

- Nearside and offside sliding side-access doors with fixed windows

Door mirrors

- Foldable electrically adjustable/heated door mirrors

Windows

- Electrically operated front windows with one-touch up/down facility
- Tailgate with heated windows and wash/wipe facility

Model Specific Features/Options

	Option code*	Combi	Design	Ultimate
Heating and Ventilation				
Air conditioning		●	●	
Dual-zone electronic climate control with rear air conditioning and roof mounted controls				●
Exterior Convenience				
Electrically operated sliding side-access doors				●

*Optional at extra cost including VAT.

Exterior Style and Lighting

Standard Features – The following features are standard across the entire New Vivaro Life Electric range. Specific features by model are outlined in the separate tabular information.

Exterior Styling

- Side protection mouldings
- Vizor

Exterior Lighting

- LED daytime running lights
- Reversing lights
- Hazard warning lights

- Rear fog lights
- High-level brake light
- Side-repeat indicators
- Lights-on audible warning

Model Specific Features

	Option code*	Combi	Design	Ultimate
Exterior Styling				
Body-colour front and rear bumper			●	●
Body-colour rear bumper			●	●
Body-colour rear corner bumper with black centre section (Design and Ultimate XL models only)			●	●
Body-colour mirror housings and door handles			●	●
Body-colour side-protection mouldings			●	●
Dark-tinted rear windows – Opacity level 70% Design and 90% Ultimate			●	●
Exterior Lighting				
Front fog lights			●	●

*Optional at extra cost including VAT.

Infotainment

Standard Features

Multimedia Pro

Features

- Multimedia Pro
 - 10-inch HD touchscreen with wireless mirror screen
 - AM/FM/DAB digital radio
 - 4G connectivity
 - Voice control
 - Two speakers and two tweeters
 - USB connection

Mobile phone portal

- Bluetooth® connectivity
- Vehicle microphone
- Phone book access – Contacts/last calls/missed calls etc. are mirrored on the display and are easily navigated using the touchscreen (features dependent on mobile phone)
- Smartphone interface – Apple CarPlay/Android Auto™

Additional feature

- Flexible roof-mounted aerial

Multimedia Pro Navi

Features over Multimedia Pro

- Multimedia Pro Navi
 - Fully integrated satellite navigation system

Driver information

- 10-inch colour digital instrument cluster
- Multi-function trip computer
- Central fascia display – including audio information, clock and outside air temperature

Please note that compatibility and certain functions may be different depending on the type of device and operating system you're using with the Multimedia systems. Apple CarPlay is a trademark of Apple Inc. Apple and iPhone are trademarks of Apple Inc., registered in the U.S. and other countries. Android is a trademark of Google Inc, also registered in the U.S. and other countries. *Services may require a subscription/fee and are subject to mobile network coverage and availability. Standard on models with Satellite Navigation only.

Vauxhall Connect*

e-Call and b-Call:

Help when you need it, 24/7, 365 days a year, that's what you get with new Vauxhall Connect. In an emergency or breakdown, you'll be put in touch with a trained advisor, with just the touch of a button.

Live Navigation Plus and more:

You can also access live navigation services, receive regular vehicle diagnostic info plus there's a host of remote convenience features available through the MyVauxhall app.

- **Peace of mind:** emergency call, breakdown call and regular vehicle status and information
- **Convenience:** remote functions (e.g. lock/unlock the door).
- **Our additional services for electric vehicles:** trip planning, remote settings or public charging solutions – we keep you going!
- **Smart driving:** enjoy a relaxed ride thanks to live navigation and trip management
- **Traffic alerts:** Live Navigation Plus introduces speed camera, traffic light camera and accident hotspot alerts



Interior Styling and Comfort

Combi



Steering wheel:

- Three-spoke design
- Satin chrome-effect bezel

Facia and door trim:

- Mistral Black/Grey

Front seating:

- Driver's seat (six-way adjustable):
 - Height - Reach - Backrest
 - Manual lumbar adjustment
 - Under seat storage - Head restraint
- Dual front passenger's seats
 - Fixed position bench seat and backrest
 - Height-adjustable front padded head restraints

Seat trim:

- Curitiba Tritone Grey fabric seat trim

Interior Styling and Comfort

Design



Steering wheel:

- Three-spoke design
- Satin chrome-effect bezel

Facia and door trim:

- Mistral Black/grey

Front Seating:

- Driver's seat (six-way adjustable):
 - Height - Reach - Backrest
 - Manual lumbar adjustment
 - Under seat storage - Head restraint
- Front passenger seat
 - Height-adjustable front padded head restraints

Seat trim:

- Curitiba Tritone Grey fabric seat trim

Interior Styling and Comfort

Ultimate



Steering wheel:

- Leather-covered
- Three-spoke design
- Satin chrome-effect bezel

Facia and door trim:

- Mistral Black with decor insert

Front Seating:

- Power driver's seat with memory and massage functions (six-way adjustable):
 - Height - Reach - Backrest
 - Lumbar adjustment - Armrest
 - Under seat storage - Head restraint
- Passenger's seat with massage functions (four-way adjustable)
 - Reach - Backrest
 - Head restraint - Armrest

Seat trim:

- Claudia black leather seat trim

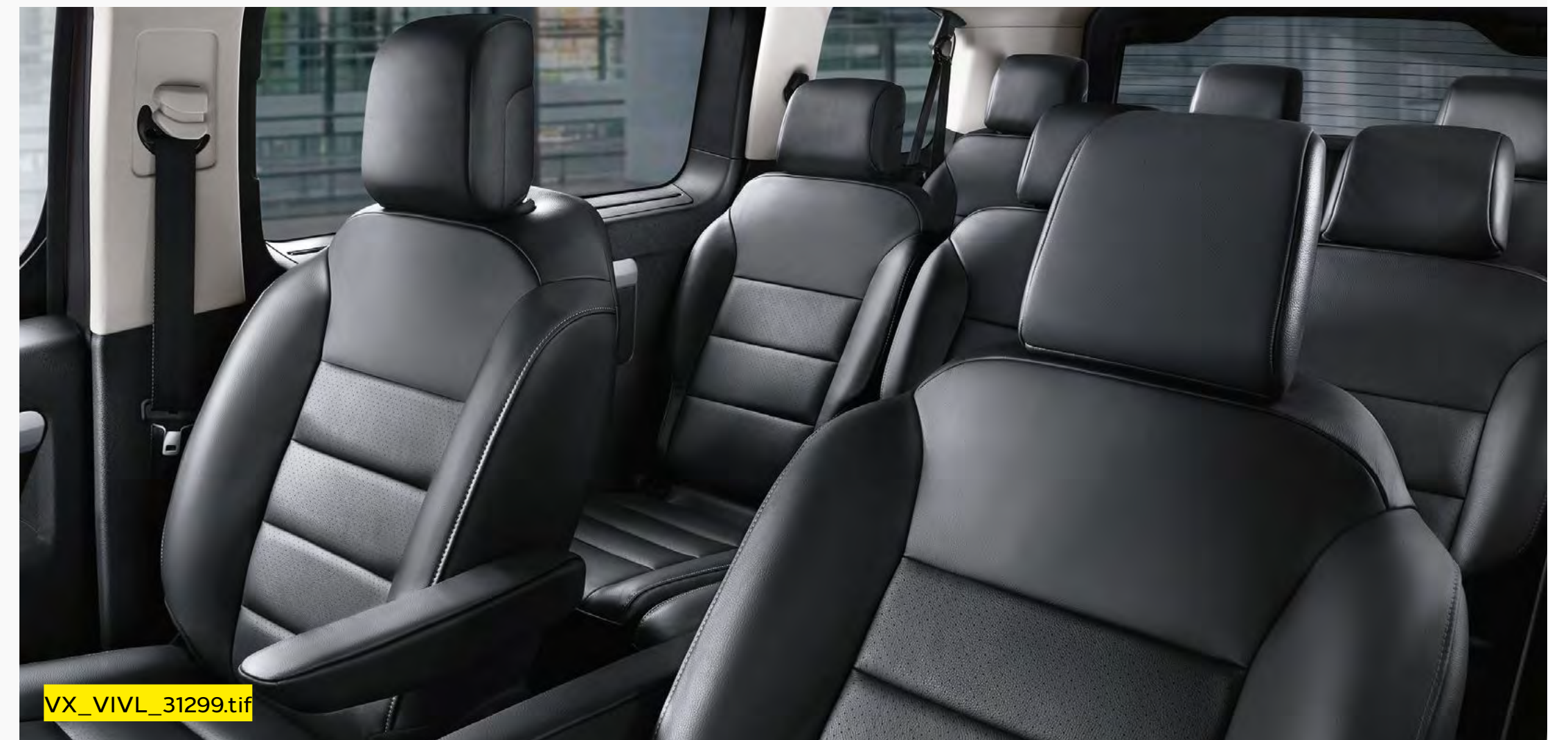

Interior Styling and Comfort – Rear seating



Model Specific Features/Options

	Option code*	Combi	Design	Ultimate
Second-row three-passenger 60/40 split bench seat with tilt function		●		
Third-row three-passenger fixed bench seat		●		
Second-row three-passenger foldable 60/40 split bench seat			●	●
Third-row three-passenger foldable 60/40 split individually sliding bench/single seat**			●	●

*Optional at extra cost including VAT. **Individually sliding function standard on Ultimate models only. †Option is standard when VIP Pack (AN01) is selected.

Exterior Colours

Arctic White (POPR)*
Solid paint



Mercury Grey (MO1J)**
Two-coat metallic paint £600



Contrast Grey (M0F4)**
Two-coat metallic paint £600



Kapari Green (MODU)**
Two-coat metallic paint £600





Carbon Black (M09V)**
Two-coat metallic paint £600



The colours reproduced may vary slightly from the actual paint colour. As a result they should be used as a guide only. Your Vauxhall Retailer has a comprehensive display of our paint samples.

*Standard exterior paint. **Optional at extra cost including VAT. †Optional at extra cost including VAT. Not available on Combi models.

Wheels and Tyres

		Electric models			
		Option code	Combi	Design	Ultimate
	<p>16-inch steel wheels with centre cap</p> <ul style="list-style-type: none"> • 215/65 R 16 tyres • Emergency tyre inflation kit (in lieu of spare wheel) 		●		
	<p>17-inch steel wheels with full-diameter trims</p> <ul style="list-style-type: none"> • 215/60 R 17 tyres • Emergency tyre inflation kit (in lieu of spare wheel) 			●	
	<p>17-inch diamond-cut alloy wheels</p> <ul style="list-style-type: none"> • 215/60 R 17 tyres • Emergency tyre inflation kit (in lieu of spare wheel) 				●

Specifications*

Single-speed electronic drive selector

All-electric single speed drive means there is no need for multiple gears. Instead the e-toggle enables the driver to select from the following:

- Park
- Reverse
- Neutral
- Drive

Drive Mode Selector

The driver can determine the driving style through selecting one of the following modes:

- **Power:** with high power reserves for the highest top speed and torque. Recommended at full capacity
- **Normal:** for a balanced drive that offers a compromise between performance and energy efficiency. WLTP range is validated in this mode
- **ECO:** for maximum range and energy efficiency. The ECO mode deactivates all unnecessary energy-consuming features and reduces the top speed, torque and overall performance

Braking

Energy recuperation

The regenerative braking system works when the vehicle is in motion, energy created by the resistance of the brakes against the drivetrain is converted into DC voltage to partially recharge the battery. The driver can also engage braking mode through the drive selector to increase the level of energy recuperation.

Single foot driving experience

The system not only utilises the energy when the brakes are being used, but also engages when the vehicle is coasting, recovering more energy and enabling single foot driving as the brakes automatically engage when the throttle pedal is released.

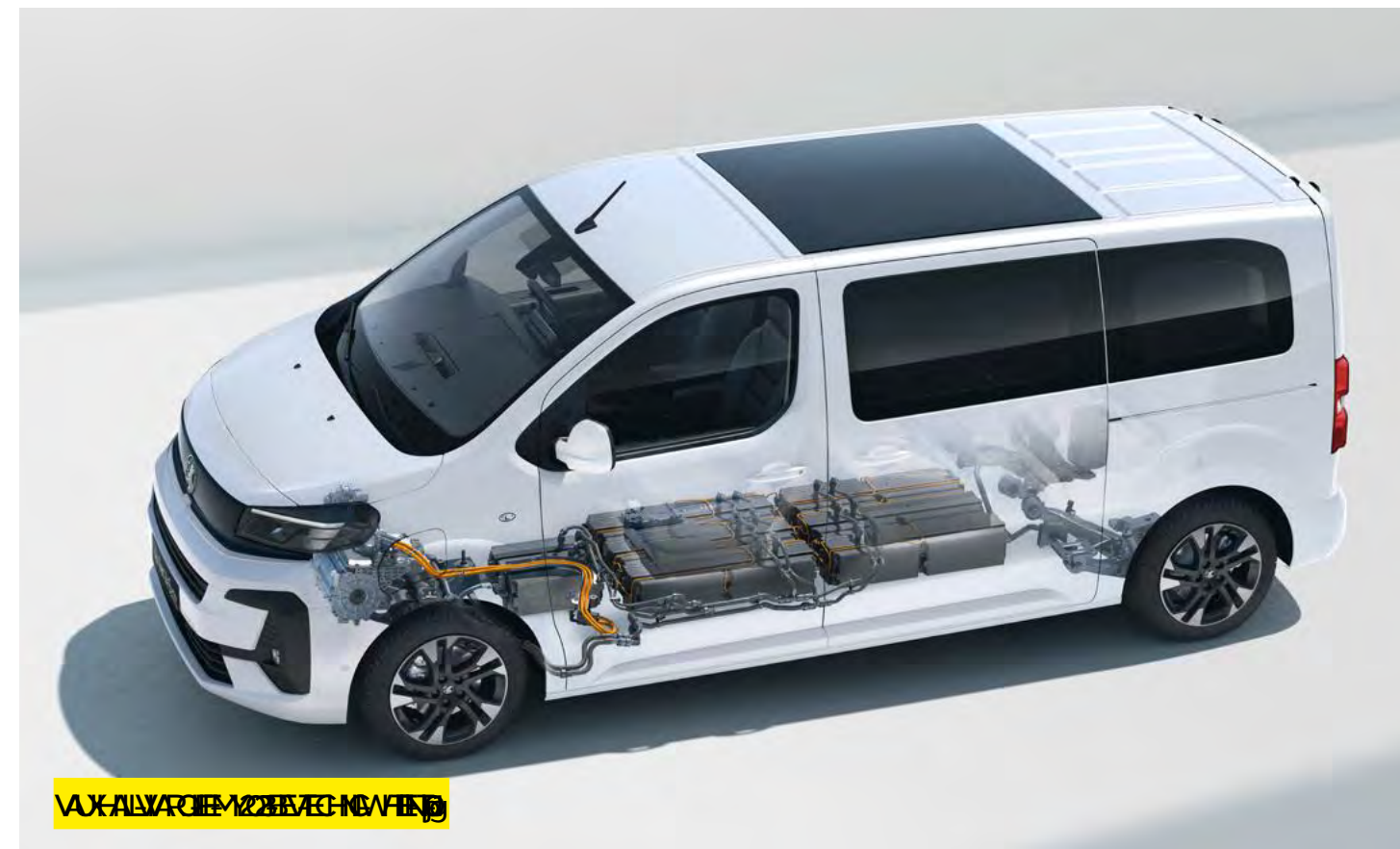

Drivetrain	New Vivaro Life Electric
CO ₂ emissions	0g/km
Maximum power	100kW (136PS)
Maximum torque	260Nm (192lb. ft.)
Acceleration 0 – 62mph	13.1 sec
Maximum speed	81mph
Transmission	Automatic electric drive with fixed gear ratio
Service interval	Every 25,000 miles or 2 years (whichever comes sooner). Initial inspection at 12,500 miles or 1 year (whichever comes sooner)

The New Vivaro Life Electric is a battery electric vehicle requiring mains electricity for charging. Range data given has been determined according to WLTP test procedure methodology. The figures shown are intended for comparability purposes only and should only be compared to other cars tested to the same technical standard. The range you achieve under real world driving conditions will depend upon a number of factors, including but not limited to: the accessories fitted (pre and post registration); charging frequency; personal driving style; vehicle load and route characteristics; variations in weather; heating/air conditioning; pre-conditioning and battery condition. For more information, contact your local Vauxhall Retailer.

*Provisional data.

Specifications*

Charging

New Vivaro Life Electric comes fitted with an 7.4kW on-board charger and mode 3 cable. An 11kW on-board charger is available as an extra cost option.

The charging flap's Padlock LED lights up when the cable is correctly plugged in and locked and then acts as a user interface to show the charging status via coloured LED lights:

- **White:** welcome light that helps to light up the area, especially useful in dark conditions
- **Flashing green:** charging in progress
- **Solid green:** charging complete
- **Solid blue:** delayed charging toggled; changes to flashing green when charging commences
- **Solid red:** malfunction

The driver may also choose from two settings:

- **Immediate charging (the standard setting):** Starts charging as soon as the vehicle is docked for charging
- **Delayed charging:** This is especially useful for when cheaper electric rates are desired, e.g. charging at night. Simply enter a charging start time

Please note, EV range assumes that vehicle has been pre-conditioned prior to journey. This function can be accessed either via MyVauxhall App (standard with all New Vivaro Life Electric models or with optional Multimedia Navi Pro).



Charging			
Supply	Socket	Charge Time (0 - 100%) - 50kWh	Charge Time (0 - 100%) - 75kWh
AC current - Domestic 3 pin socket (2.3kW)	Type 2	21h 45m	36h 45m (100%)
AC current - Home wallbox or public charger (7kW)	Type 2	7h 30m	11h 20m (100%)
AC current - Public charger (11kW)**	Type 2	5h	7h 30m (100%)
DC current - Rapid charger (100kW)	CCS	30m (0 - 80%)	45m (5 - 80%)

Battery		
Battery capacity	50kWh	75kWh
AC on-board charger speed (standard)	7.4kW	7.4kW
WLTP Range (Combined)	tbc	tbc
WLTP Range (City)	tbc	tbc
Energy consumption (Combined low/high)	25.3 - 25.7kWh/100km	tbc
Battery warranty	8 years/100,000 miles/70% capacity	8 years/100,000 miles/70% capacity
Range	139 mile	217 mile

The New Vivaro Life Electric is a battery electric vehicle requiring mains electricity for charging. Range data given has been determined according to WLTP test procedure methodology. The figures shown are intended for comparability purposes only and should only be compared to other cars tested to the same technical standard. The range you achieve under real world driving conditions will depend upon a number of factors, including but not limited to: the accessories fitted (pre and post registration); charging frequency; personal driving style; vehicle load and route characteristics; variations in weather; heating/air conditioning; pre-conditioning and battery condition. For more information, contact your local Vauxhall Retailer.

*Provisional data. **Requires optional 11kW on board charger.

Dimensions and Capacities All measurements in mm (inches) unless stated otherwise.

Loadspace Dimensions	M (Medium)	L (Long)
Maximum load length – Passenger’s seat folded	3161 (124.5)	3511 (138.2)
Maximum load length – Behind front seats	2413 (95.0)	2763 (108.8)
Maximum width	1618 (63.7)	1618 (63.7)
Width between wheel arches	1228 (48.3)	1228 (48.3)
Maximum height	1337 (52.6)	1339 (52.7)
Loadspace Access		
Side door aperture height	1181 (46.5)	1181 (46.5)
Side door aperture width	933 (36.7)	933 (36.7)
Rear door aperture height	1181 (46.5)	1181 (46.5)
Rear door aperture width	1212 (47.7)	1212 (47.7)
Loading height – Maximum	653 (25.7)	664 (26.1)
Loading height – Minimum	584 (23.0)	584 (23.0)
Loadspace Volumes – cu.m (cu.ft.)		
Maximum volume to roof level	3.9 (137.7)	4.5 (158.9)
Maximum volume to seat back level	3.0 (105.9)	3.5 (123.6)

M (Medium)

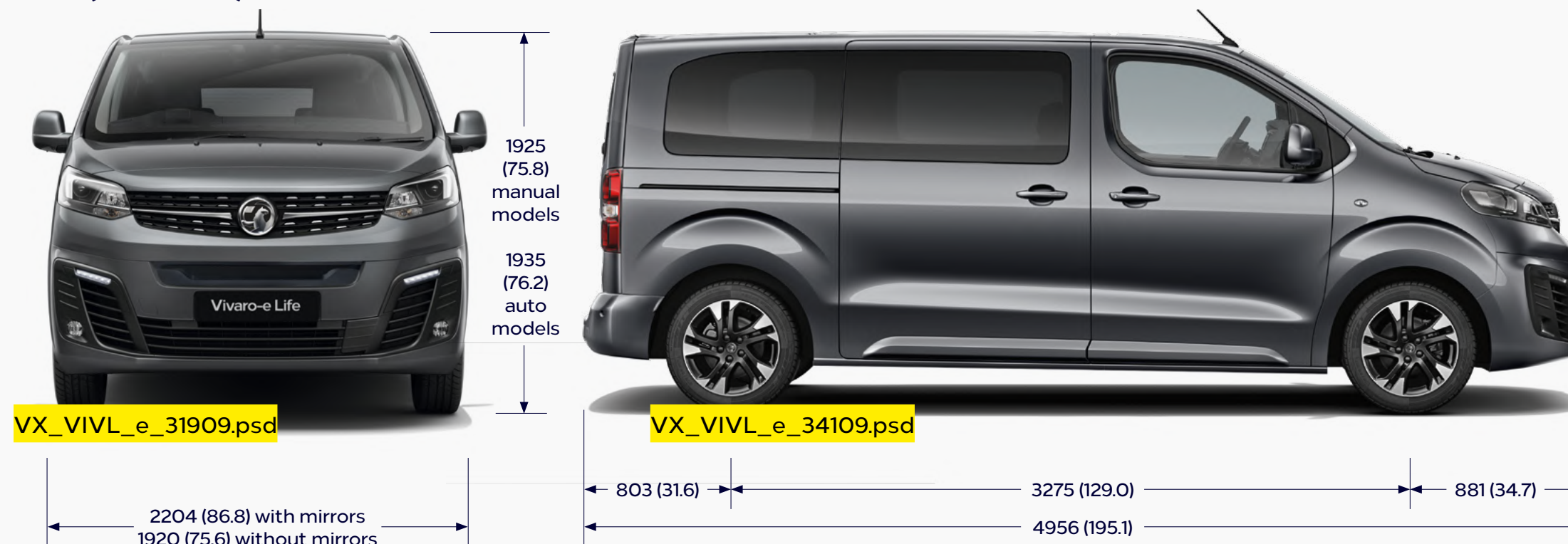

L (Long)

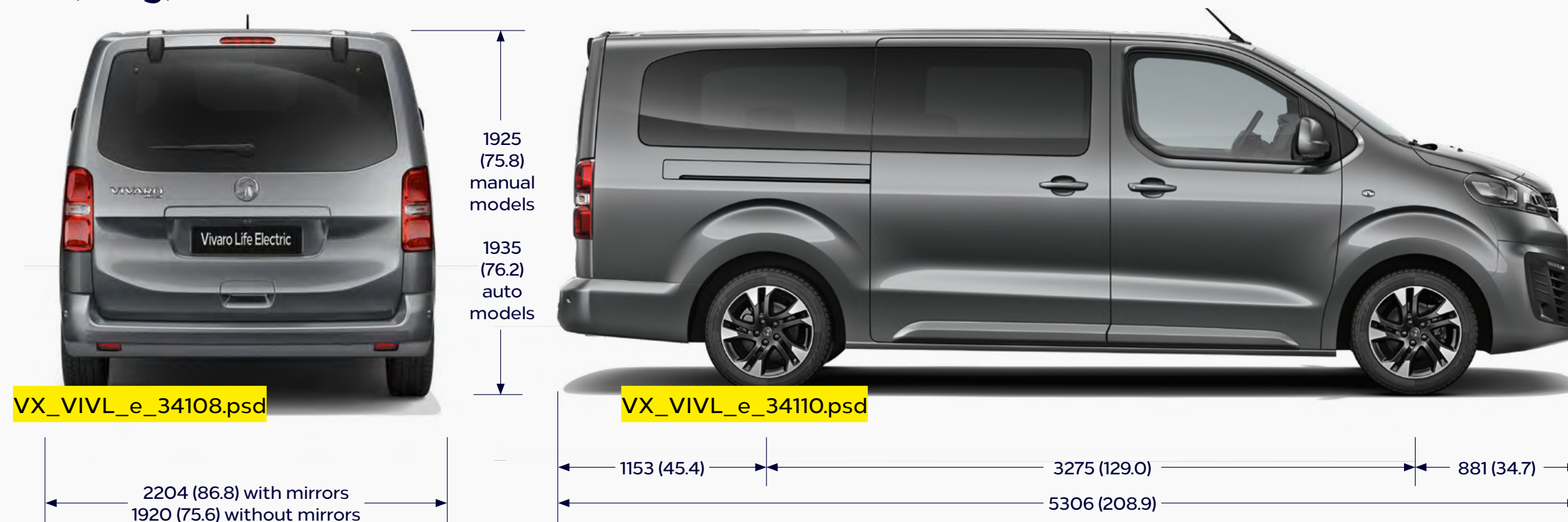

Company Car Driver and Fleet Information

Benefit in kind company car taxation*

The car benefit charge will be the car's list price (including VAT, options and accessories fitted, delivery to Retailer and number plates, but excluding Vehicle Excise Duty and new vehicle first registration fee) multiplied by the percentage charge for the CO₂ emissions band in which the car falls (see table opposite). Multiply this figure by your personal income tax rate (20%** for Basic Rate, 40%** for Higher Rate) to calculate your annual benefit in kind tax liability.

Generic example:

ELECTRIC vehicle: 0g/km CO₂

On-the-road RRP	£27,305.00
Deduct: Vehicle Excise Duty	£0.00
New vehicle first registration fee	-£55.00
Effective list price	£27,250.00
Add: Optional two-coat metallic paint	£600.00
List price for tax purposes (P11D value)	£27,850.00
Car benefit charge 2023 – 24 tax year (2%)	£557.00
Benefit in kind tax liability	
Basic Rate (20%) tax payer	£111.40
Higher Rate (40%) tax payer	£222.80

*Please note this Price Guide provides taxation information as a guide only. Vauxhall does not provide taxation guidance. Drivers should always take professional advice on their own tax position.

**Excludes residents of Scotland.

BiK for Scottish Residents

Effective 6 April 2018 the Scottish Government have introduced their own BiK taxation structure. This only applies to Company Car Drivers that are Scottish taxpayers. HMRC will determine whether or not an individual is a Scottish taxpayer based on where their main place of residence is.

The BiK rates for Scotland are:

- Over £12,570 – £14,732 Starter Rate 19%
- Over £14,732 – £25,688 Basic Rate 20%
- Over £25,688 – £43,662 Intermediate Rate 21%
- Over £43,662 – £150,000 Higher Rate 41%
- Above £150,000 Top Rate 46%

CO ₂ emissions (g/km)	Electric range (miles)	Percentage of cars price to be taxed 2023 – 24 tax year
0	-	2%
1 – 50	130+	2%
1 – 50	70 – 129	5%
1 – 50	40 – 69	8%
1 – 50	30 – 39	12%
1 – 50	<30	14%

To calculate your own personal liability, search: **Vauxhall BiK**, or click the link below:

[Vauxhall BiK Tool](#)

Fleet Toolbox

Discover the facts in our online Toolbox for both Company Car Drivers and Fleet Decision Makers. The Fleet Toolbox has a host of useful calculators, comparators, interactive listings and information.

Search Vauxhall Fleet Tools or click the link below:

[Vauxhall Fleet Tool Box](#)

Contact Vauxhall Fleet

Please contact one of our dedicated sales teams who will be happy to help with your particular enquiry.

Fleet Decision Makers

Depending on the size of your fleet of vehicles, we have a dedicated team to handle your enquiries. The lines are open Monday to Friday excluding Bank Holidays.

1 – 24 vehicles

Call: 0203 885 4560 (8:30am – 5:00pm)

Email: enquiries@stellantis-fleet.co.uk

50+ vehicles

Call: 0203 885 4562 (8:30am – 5:00pm)

Email: enquiries@vauxhallfleet.co.uk

Special Vehicles (Police, Fire and Ambulance)

Call: 01582 409999

Email: psvo@stellantis.com

Further Information

On-the-road prices

To eliminate uncertainty about hidden costs when buying a new car, Vauxhall publishes on-the-road recommended retail prices (RRP) and these are shown in the pricing tables within this price guide. These prices include VAT, number plates and delivery to Retailer of £900.00 (including £150.00 VAT), 12 months' Government Vehicle Excise Duty (see opposite for details) and the DVLA new vehicle first registration fee of £55.00.*

Please note: The on-the-road recommended retail price (RRP) does not include fuel supplied by the Retailer, motor insurance or any other goods or services supplied by agreement between the Retailer and the customer.

Price protection

Order a new Vauxhall for build in the current model year (as confirmed by your Retailer) for delivery no more than three months in advance and the price you are quoted is the price you pay. This is irrespective of any subsequent price rises between placing your order and delivery of your new car, but you must take delivery as soon as the car is available.

Please note: Vauxhall Motors Limited is not liable for price adjustments caused by Government changes in the rate of VAT (currently 20%), Vehicle Excise Duty, DVLA new vehicle first registration fee or by any other applicable legislation or regulations.

In the event of an accident

Vauxhall Accident Management helps keep you mobile following an accident. Benefits include vehicle recovery, Vauxhall-approved repairs and contacting your insurer. For more details, visit vauxhall.co.uk/AccidentManagement

LEASYS

Leasys UK

Leasys is the proud Business Contract Hire partner of Vauxhall and consequently, can provide quick vehicle delivery to keep your business mobile.

Specialised in Medium to Long-Term Leasing options and Fleet Management solutions for businesses of all sizes, [Leasys](#) lead mobility by offering sustainable and innovative solutions designed around customers, for a best-in-class experience. Their team of experts can personally support you and provide dedicated consultation.

[Leasys](#) is equally owned by Stellantis and Crédit Agricole Consumer Finance and is a member of the British Vehicle Rental and Leasing Association (BVRLA).

For further information, please contact your local Vauxhall Retailer or visit leasys.com/uk

Vehicle Excise Duty

The amount of Vehicle Excise Duty (road fund licence) payable on new cars varies depending on the level of carbon dioxide (CO₂) emissions produced by the vehicle. CO₂ emissions are measured in grams per kilometre (g/km) travelled and divided into 13 charging bands shown in the table opposite.

A 'first year rate' of Vehicle Excise Duty is payable on all new cars and in subsequent years the amount payable reverts to the 'standard rate'. Also, for vehicles with a list price over £40,000, including factory-fitted options, an additional £390 is payable for the first five years of standard rate payments.

Vehicle Excise Duty*

Band	CO ₂ emissions in grams per kilometre	Standard rate Electric
A	0	£0
B	1 – 50	-
C	51 – 75	-
D	76 – 90	-
E	91 – 100	-
F	101 – 110	-
G	111 – 130	-
H	131 – 150	-
I	151 – 170	-
J	171 – 190	-
K	191 – 225	-
L	226 – 255	-
M	Over 255	-

*Correct at time of issue.

Further Information

Customer Care Commitment

For added peace of mind, Vauxhall has an innovative Customer Care Commitment that offers the following:

- Three-year vehicle warranty consisting of a one-year/unlimited mileage manufacturer's warranty and a second and third year manufacturer's warranty with a 60,000 miles limitation
- Vauxhall Assistance for 12 months from first registration
- Six years' body panel anti-perforation warranty

Please note: Warranty is only available on vehicles sourced from Vauxhall Motors Limited. Terms and conditions apply – please see your Vauxhall Retailer for details.

Vauxhall Assistance

Vauxhall Assistance is provided automatically with every new Vauxhall for 12 months from first registration and covers everything from accident assistance, roadside recovery and 'at home' service to flat tyres. For even more peace of mind, on fully electric models, the cover is extended* to 3 years. Even more reason for you to stay calm and let us take care of everything should the need arise. With Vauxhall Assistance help is literally just a free** phone call away, 24 hours a day, 365 days a year!

Protecting the environment

Vauxhall's commitment to the environment is demonstrated by our products' many environmental awards. For even more information on Vauxhall's efforts to achieve an environmentally sustainable future, and how to dispose of your end-of-life vehicle, see vauxhall.co.uk/recycling

Vauxhall Care

This all-inclusive service package is available on Vauxhalls under 10 months old (from date of first registration).

This package offers complete peace of mind for the first 3 years of your Vauxhall's life with fixed monthly payments for the plan duration.

- **3 years' Vauxhall servicing** – covers first, second and third annual services. Including a brake-fluid change in the second service
- **2 years' Vauxhall Roadside Assistance** – first year from us
- **First years' MOT[†]** – free of charge by your local Vauxhall Retailer

For full terms and conditions and to sign up, visit: vauxhall.co.uk/vauxhallcare

Vauxhall Service Club

Vauxhall Service Club is available for all Vauxhall owners, and it's free to join. Members benefit from the following:

- 15% off Vauxhall Approved Accessories
- Vauxhall's aged 2-3 Years = 15% off parts and labour
- Vauxhall's aged over 3 Years = 25% off parts and labour
- Half price MOT's (NI excluded)
- Free pre-MOT test inspection (NI only)
- Fixed price AdBlue[®] Refills
 - Car = £14.99
 - Van = £24.99
- Access to the Vauxhall Accident Management Programme
- Online service booking available 24/7 with servicing appointments available within 3 days – [Book Online](#)
- Collection and delivery/onward mobility options
- Complimentary 'Wash and Vac' with all routine services^{††}
- Vauxhall trained technicians
- Genuine Vauxhall parts
- Minimum 12 months warranty on parts and labour
- Regular newsletters with exclusive offers, discounts and competitions

Terms and conditions apply. To join visit: vauxhall.co.uk/serviceclub

Vauxhall Insurance with added reassurance

Comprehensive cover – Summary of benefits

- Competitive premiums
- Repairs by a Vauxhall-trained technician
- Genuine Vauxhall parts, guaranteed for five years when we repair your car within our Approved Repairer Network
- Free courtesy car as standard when using an Approved Repairer[‡]
- 24 hour claims helpline
- Personal Accident benefit
- Cover for audio equipment
- Windscreen cover

Call for a quote on 0330 678 1130^{‡‡}

For more product information

For further information on the Vauxhall range or location of your nearest Vauxhall Retailer please call 0800 026 0034. Alternatively, details can be found on our website at vauxhall.co.uk

For more information call **0800 026 0034**

For Fleet enquiries call **0203 476 2268**

Discover the full Vauxhall range at **[vauxhall.co.uk](https://www.vauxhall.co.uk)**

Join us online

The invoice price, including delivery to Retailer, factory-fitted options, accessories fitted by the Retailer and number plates, is subject to VAT. Some feature descriptions in this guide may refer to, and some illustrations may show, optional equipment not included in the standard delivery. The information contained in this guide was accurate at the time of publication. We reserve the right to make changes in design and equipment. Please note that Vauxhall Retailers are not the agents of Vauxhall Motors Limited and are not authorised to bind Vauxhall Motors Limited by any specific or implied undertaking or representation. It is advisable to ensure that your motor insurance policy provides adequate cover for additional fitted options and accessories. The colours in this guide are only approximate actual colours. Illustrated optional equipment is available at extra charge. Availability, technical features and equipment provided on our vehicles can vary by model. For precise information on the equipment provided on our vehicles, please contact your local Vauxhall Retailer.

VAUXHALL