

COMMERCIAL VEHICLE

PRICE/SPECIFICATION RANGE GUIDE

1 April 2018 | Model Year 2018

MY 2018



VAUXHALL

Range pricing information

Contents

Corsavan Prices	3
Corsavan Equipment / Options	4
Combo Prices	13
Combo Equipment / Options	17
Vivaro Prices	25
Vivaro Equipment / Options	30
Movano Prices	45
Movano Conversions2Go	58
Movano Equipment / Options	59
Glossary of Terms	73
Customer Care	74
Corsavan Specifications	75
Combo Specifications	76
Vivaro Specifications	79
Movano Specifications	84
Accessories	98

Vauxhall on-the-road recommended retail prices (RRP)

To eliminate uncertainty about hidden costs incurred when buying a new commercial vehicle, Vauxhall publishes on-the-road prices and these are shown in the pricing tables within this price guide. The prices shown are manufacturer's recommended retail prices (RRP) unless otherwise stated, exclusive of VAT (currently at a rate of 20% which may be payable). These prices include the recommended cost of number plates, delivery to a Vauxhall Retailer of £583.33 (£700.00 including VAT), 12 months' Government Vehicle Excise Duty* (shown on each model page) and the DVLA new vehicle first registration fee of £55.00*.

Please note: The RRP does not include fuel supplied by the Retailer, motor insurance or any other goods or services supplied by agreement between the Retailer and customer.

*Correct at time of publication.

Price protection for all Vauxhalls

Order a new Vauxhall for build in the current model year (as confirmed by your Retailer) for delivery no more than three months in advance and the price you are quoted is the price you pay. This is irrespective of any subsequent price rises between placing your order and delivery of your new commercial vehicle, but you must take delivery as soon as the commercial vehicle is available. Vauxhall Motors Limited is not liable for price adjustments caused by Government changes in the rate of VAT (currently 20%), Vehicle Excise Duty, DVLA new vehicle first registration fee or by any other applicable legislation or regulations.

CORSAVAN PRICES



Model	Minimum Mass (kg)*	Payload (kg)*	Fuel economy mpg (litres/100km)#			CO ₂ emissions (g/km)#	Price (£) exc. VAT	On-the-road RRP (£) exc. VAT
			Urban driving	Extra-urban driving	Combined figure			
CORSAVAN (EURO 6)								
1.2i (70PS)	1045	560	42.2 (6.7)	61.4 (4.6)	52.3 (5.4)	126	12175.00	13063.33
1.3CDTi (75PS) Start/Stop	1124	571	55.4 (5.1)	83.1 (3.4)	70.6 (4.0)	107	13425.00	14313.33
1.3CDTi (95PS) Start/Stop ecoTEC	1124	571	68.9 (4.1)	88.3 (3.2)	78.5 (3.6)	94	13875.00	14763.33
1.3CDTi (95PS) Start/Stop ecoTEC Easytronic	1124	581	70.6 (4.0)	91.1 (3.1)	83.1 (3.4)	91	14495.00	15383.33
CORSAVAN SPORTIVE (EURO 6)								
1.3CDTi (95PS) Start/Stop	1177	543	57.6 (4.9)	78.5 (3.6)	68.9 (4.1)	108	14875.00	15763.33

Please note: On-the-road recommended retail prices (RRP) include number plates and delivery to Retailer of £583.33 (exc. VAT), 12 months' Vehicle Excise Duty at £250.00 and new vehicle first registration fee of £55.00. Excludes fuel and insurance.

* = For definitions please refer to Glossary of Terms.

= Fuel consumption information is official government environmental data, tested in accordance with the relevant EU directive. Official EU-regulated test data is provided for comparison purposes and actual performance will depend on driving style, road conditions and other non-technical factors.

CORSAVAN EQUIPMENT / OPTIONS

SAFETY	Corsavan	Sportive	Price (£) exc. VAT
Airbags: • Driver's dual-stage airbag • Passenger's dual-stage airbag with deactivation switch • Side-impact airbags • Full-size-curtain airbags	●	●	
Seating: • Height-adjustable seat head restraints • Anti-submarining ramps – <i>Helps prevent occupants sliding underneath the lap belt during a collision.</i>	●	●	
Seatbelts: • Inertia-reel lap and diagonal seatbelts • Height-adjustable seatbelts • Seatbelt pretensioner system – <i>Pretensioners tighten the seatbelt in the event of an accident limiting forward movement.</i> • Seatbelt force limiters – <i>Reduces potential upper body injuries during a frontal impact.</i> • Seatbelt unfastened audible warning and warning light	●	●	
Body: • Pedal release system – <i>Reduces potential injury to the driver's legs and feet during a severe frontal impact.</i> • Laminated windscreen • Side-impact protection beams • Reinforced passenger safety cell • Fuel tank located ahead of rear axle	●	●	
Stability: Electronic Stability Programme+plus (ESP+plus) with traction control – <i>Works in conjunction with the vehicle's electronic braking and engine systems to keep the vehicle stable in many different situations. ESP monitors a variety of inputs to determine when the vehicle starts to lose traction, it can then immediately respond by varying the brake pressure between up to three wheels and adjust the engine output to help correct the loss of traction and improve stability.</i> Drag torque control – <i>Helps maintain stability when suddenly lifting off the accelerator.</i>	●	●	
Tyre pressure: • Tyre pressure monitoring system	●	●	
Braking: Four-channel Anti-lock Braking System (ABS) – Prevents the vehicle's wheels from locking up under heavy braking by momentarily reducing brake pressure at the appropriate wheel, ensuring that you can maintain control of the steering. Emergency brake assist – <i>When emergency braking is detected the vehicle automatically applies the maximum possible braking assistance.</i> Electronic brakeforce distribution – <i>Automatically apportions the optimum braking force to each wheel.</i> Hill start assist – <i>Briefly maintains rear brake pressure to stop the vehicle rolling back on an incline.</i> Cornering brake control / Straight line stability control – <i>Senses the different speeds of each wheel and applies differing braking levels to each one to ensure the whole vehicle remains under control.</i>	●	●	
SECURITY			
Features: • Electronic engine deadlock immobiliser • Steering column lock • Electronic theft protection for audio equipment • 'Key left in ignition' audible warning • Visible Vehicle Identification Number (VIN) • Locking wheel bolts for alloy wheels	●	●	
Remote control door locking (doors, tailgate and fuel flap): • Remote control door locking • Two folding keys with integral remote • Door deadlocks	●	●	
Security alarm system: • Remote control – <i>Operates in conjunction with central locking.</i> • Tilt sensor • Thatcham approved	○	○	220.00

● = Standard equipment. ○ = Optional at extra cost.

Option code: XiC5

CORSAVAN EQUIPMENT / OPTIONS

COMFORT AND SEATING

	Corsavan	Sportive	Price (£) exc. VAT
Comfort: • Steering column adjustable for reach and rake • Leather-covered steering wheel (Sportive models) • Floor-mounted handbrake lever • Spot Shimmer black cloth seat trim (Standard models) • Lace cloth seat trim (Sportive models) • Height-adjustable seatbelts	●	●	
Seating: • Reach • Backrest recline • Easy-entry seats with memory function	●	●	
• Driver's seat height adjuster Option code: AH3	○	●	70.00
• Sports-style seats		●	

INTERIOR CONVENIENCE

Accessory sockets: • Facia-mounted 12-volt accessory socket	●	●	
Interior: • Storage box on driver's side lower facia • Illuminated glovebox with lid • Coin holder • Drinks holder in centre console • Door pockets • Dipping rear-view mirror • Twin sunvisors, driver's with vanity mirror and cover • Chrome-effect door handles and handbrake button • Driver and passenger's tilttable assist handles • Automatic anti-dazzle rear-view mirror	●	●	
Lighting: • Centre fade up/fade down courtesy light • Map reading lights	●	●	
• Ambient lighting		●	

DRIVER ASSISTANCE

Automatic anti-dazzle rear-view mirror		●	
Cruise control, includes leather-covered steering wheel Option code: N34	○	●	120.00
Speed limiter – These are factory-fitted speed limiters that cannot be adjusted by driver: • Choice of two speeds: 62mph / 68mph – <i>Only available on 1.3CDTi (95PS) manual models.</i>	○		85.00
Windscreen wipers: • Two-speed windscreen wipers • Variable intermittent wipe • Electric screenwash • Intermittent rear windows wash/wipe • Rain-sensitive windscreen wipers	●	●	
Parking assistance: • Rear parking distance sensors • Audible warning • Distance warning graphic showing in driver information display Option code: UD7	○	○	260.00
• Rear-view camera • Camera view appears in infotainment screen • Rear bumper and one-metre grid lines shown as reference points – <i>Activated when reverse gear selected.</i> <i>Requires rear parking distance sensors and IntelliLink.</i> Option code: UVC		○	235.00

● = Standard equipment. ○ = Optional at extra cost.

CORSAVAN EQUIPMENT / OPTIONS

DRIVER INFORMATION

	Corsavan	Sportive	Price (£) exc. VAT
Instrumentation: • Speedometer • Rev counter • Fuel gauge with low fuel warning light • Fuel economy gauge • Coolant temperature warning light	●	●	
ECO features: • Shift-up indicator – Indicates when to change gear for optimum fuel economy.	●	●	
Driver information display: • Monochrome display located in instrument cluster • Odometer • Service-due indicator	●	●	
Central facia display: • Audio information • Digital clock with automatic RDS time adjustment • Outside air temperature with ice warning function • Additional features and location dependent on infotainment unit (see Infotainment for details)	●	●	
Warning indicators: • Low oil level, low brake fluid, brake pad wear, battery, seatbelt warning, doors open, headlight / brake light failure and handbrake on	●	●	

INFOTAINMENT

CD 30 BT: Onboard features: • CD/MP3 CD player • DAB digital radio • AM/FM stereo radio with 36-station presets • RDS with Traffic Programme • Four speakers • 20 watts per channel output Media connections: • USB connection with iPod control • Aux-in socket Mobile phone portal: • Bluetooth® connectivity • Handsfree calls via steering wheel controls • Vehicle microphone • Phone book access – <i>Contacts / last calls / missed calls etc. (features dependent on mobile phone)</i>	●	●	
R4.0 IntelliLink touchscreen infotainment system: <i>For use with MP3 players, USB memory sticks, mobile phones and smartphone apps</i> Onboard features: • DAB digital radio • AM/FM stereo radio with 36-station presets • 7-inch facia-mounted colour touchscreen • RDS with Traffic Programme • Four speakers • 20 watts per channel output Media connections: • USB connection with iPod control • Bluetooth® audio streaming (A2DP Profile) Mobile phone portal: • Bluetooth® connectivity • Handsfree calls via steering wheel controls • Vehicle microphone • Phone book access – <i>Contacts / last calls / missed calls etc. are mirrored on the display and are easily navigated using the touchscreen (features dependent on mobile phone).</i> Option code: CR03	○	○	760.00
Additional features: • Steering wheel mounted audio controls • Flexible roof-mounted aerial	●	●	

● = Standard equipment. ○ = Optional at extra cost.

CORSAVAN EQUIPMENT / OPTIONS

HEATING AND VENTILATION

	Corsavan	Sportive	Price (£) exc. VAT
Air blend heater: • Four-speed fan • Illuminated controls • Four adjustable facia vents • Windscreen demist vents • Side window demist vents	●	●	
Air conditioning: • Air recirculation facility • Cabin particulate filter – <i>Removes dust, airborne particles and pollen</i> • Illuminated controls Option code: C60	○	●	435.00
Electronic climate control: • Incorporating air conditioning • Single-zone control • Six-speed fan • Advanced predictive logic control system using sun sensor • Cabin particulate filter • LCD temperature display • Automatic air direction and fan speed with manual override • Illuminated controls • Pollen filter – <i>On Corsavan, only in conjunction with air conditioning.</i> Option code: C68	○	○	360.00
Winter Pack: • Heated leather-covered steering wheel • Heated seats – <i>On Corsavan, only available in conjunction with cruise control.</i> Option code: OBL	○	○	205.00

LOAD ACCESS

Rear glazed tailgate: • Heated rear window with wash/wipe facility • Interior tailgate handle	●	●	
---	---	---	--

LOAD RESTRAINT / PROTECTION

Load anchorage: • Load restraint lashing eyes	●	●	
• Cargo net Option code: BNN	○	○	35.00
• Fixing points for cargo net Option code: V91	○	○	35.00
Load lining: • Half-height plastic side load lining panels	●	●	
Bulkhead: • Half-height steel bulkhead	●	●	
Load area rubber floor mat Option code: BG9	○	○	55.00
Upper load restraint mesh Option code: AP9	○	○	75.00
Load compartment cover Option code: B75	○	○	55.00
Illuminated load area	●	●	

● = Standard equipment. ○ = Optional at extra cost.

Please note: The air conditioning in vehicles with N1 type approval relies upon fluorinated greenhouse gases (R134a) for its functioning. The front system contains a quantity of overall 580g of R 134a, which corresponds to a CO₂ equivalent of 0.83 tons. The front and rear system contains a quantity of overall 890g of R 134a, which corresponds to a CO₂ equivalent of 1.27 tons. The global warming potential amounts to 1430. Information acc. to R (EU) No. 517/2014.

CORSAVAN EQUIPMENT / OPTIONS

EXTERIOR CONVENIENCE / STYLING





	Corsavan	Sportive	Price (£) exc. VAT
Windows:			
• Heated windscreen	○	●	100.00
• Electrically operated windows • Tinted windows • Heated rear window	●	●	
Door mirrors:			
• Foldable electrically adjustable door mirrors – <i>Heated on Sportive models</i> • Wide-angle mirror on driver's side	●	●	
Exterior Styling:			
• Body-colour door mirrors	●	●	

EXTERIOR LIGHTING

Standard lighting:		
• Halogen headlights • Welcome lighting • Lights-on audible warning • Electric headlight beam levelling • Reversing light	●	●
• Hazard warning lights • Rear fog light • Adaptive brake lights • High-level LED centre brake light • Side-repeat indicators		
• Daytime running lights – <i>LED on Sportive models.</i>		
• Front fog lights – <i>With chrome-effect surround.</i>		●
Automatic lighting control		●

● = Standard equipment. ○ = Optional at extra cost.

CORSAVAN EQUIPMENT / OPTIONS





EXTERIOR COLOURS			Corsavan	Sportive	Price (£) exc. VAT	
	Summit White (GAZ) • Solid paint		Aegean Blue (G7i) • Solid paint	●	N/C	
	Lava Red (GG7) • Brilliant paint			○	N/C	260.00
	Mineral Black (GB9) • Two-coat metallic paint		Satin Steel Grey (GF6) • Two-coat metallic paint			
	Sovereign Silver (GAN) • Two-coat metallic paint		Quantum Grey (GK3) • Two-coat metallic paint	○	N/C	390.00
	Darkmoon Blue (GDY) • Two-coat metallic paint					

● = Standard equipment. ○ = Optional at extra cost. N/C = No-cost option.

The colours reproduced may vary slightly from the actual paint colour. As a result they should be used as a guide only. Your Vauxhall Retailer has a comprehensive display of our paint samples.

CORSAVAN EQUIPMENT / OPTIONS



WHEELS AND TYRES

		Corsavan	Sportive	Price (£) exc. VAT
Full-size steel spare wheel		●		
Steel space-saver spare wheel			●	
	14-inch steel wheels with flush covers – Petrol models: <ul style="list-style-type: none"> • 185/70 R 14 tyres • Full-size steel spare wheel 	●		
	15-inch steel wheels with flush covers – Diesel models: <ul style="list-style-type: none"> • 185/65 R 15 tyres • Full-size steel spare wheel 	●		
	16-inch alloy wheels: <ul style="list-style-type: none"> • 195/55 R 16 tyres • Steel space-saver spare wheel 		●	
	16-inch black alloy wheels: <ul style="list-style-type: none"> • 195/55 R 16 tyres • Steel space-saver spare wheel 		○	110.00

Option code: RV5

● = Standard equipment. ○ = Optional at extra cost.

TYRE RATINGS

Tyre size	Fuel efficiency group	Wet grip performance	External noise	
			Measured (dB)	Group
185/70 R 14	B	B	70	
185/65 R 15	B-C	B	69-70	
195/55 R 16	B-C	B	68-71	

Tyre rating according to EU Regulation 1222/2009

CORSAVAN EQUIPMENT / OPTIONS

MECHANICAL

	Corsavan	Sportive	Price (£) exc. VAT
Standard features: • Front-wheel drive • Transverse engine / gearbox • Gas-pressure dampers • Front anti-roll bar	●	●	
Transmissions: • Five-speed manual gearbox	●		
• Six-speed manual gearbox		●	
• Five-speed Easytronic transmission – Available on 1.3CDTi (95PS) ecoTEC models.	○		See prices page
Steering: • Speed-sensitive electrically assisted power steering – Variable rate on diesel models. • Rack and pinion • City-mode button providing lighter steering at parking speeds Turning circle: Kerb-to-kerb All models 10.6m (34.8ft.)	●	●	
Brakes: Front ventilated disc brakes: • 257mm diameter (1.2i models) • 284mm diameter (1.3CDTi models) Rear drum brakes: • 228mm diameter (all models)	●	●	
Fuel tank: • 45 litres (9.9 gallons) capacity	●	●	
Electrical: Maintenance-free battery: • 40Ah (1.2i models) • 60Ah (1.3CDTi models) Alternator: • 130A (1.2i models) • 140A (1.3CDTi models)	●	●	
Front suspension: • Independent lightweight MacPherson struts • Coil springs • Telescopic gas-pressure dampers	●	●	
Rear suspension: • Compound crank • Coil springs • Gas pressure dampers	●	●	

● = Standard equipment. ○ = Optional at extra cost.

COMBO PANEL VAN PRICES

BEST SMALL TRADES VAN
Vauxhall Combo 1.3CDTi
2300LH1 95ps Eu6
ecoFlex S/Stop



Model	Minimum Mass (kg)*	Payload (kg)*	Fuel economy mpg (litres/100km)#			CO ₂ emissions (g/km)#	Price (£) exc. VAT	On-the-road RRP (£) exc. VAT
			Urban driving	Extra-urban driving	Combined figure			
L1 H1 PANEL VAN (EURO 6)								
2000 1.4i (95PS) Start/Stop	1355	740	30.7 (9.2)	49.6 (5.7)	40.4 (7.0)	163	14840.00	15728.33
2000 1.3CDTi (95PS)	1365	740	43.5 (6.5)	67.3 (4.2)	56.5 (5.0)	133	16125.00	17013.33
2000 1.3CDTi (95PS) Start/Stop	1365	740	52.3 (5.4)	68.9 (4.1)	61.4 (4.6)	120	16410.00	17298.33
2000 1.6CDTi (105PS)	1395	768	44.8 (6.3)	64.2 (4.4)	55.4 (5.1)	134	17115.00	18003.33
2000 1.6CDTi (105PS) Start/Stop	1395	768	53.3 (5.3)	68.9 (4.1)	62.8 (4.5)	120	17400.00	18288.33
2300 1.3CDTi (95PS)	1395	990	43.5 (6.5)	67.3 (4.2)	56.5 (5.0)	133	16320.00	17208.33
2300 1.3CDTi (95PS) Start/Stop	1395	990	52.3 (5.4)	68.9 (4.1)	61.4 (4.6)	120	16605.00	17493.33
2300 1.6CDTi (105PS)	1465	1018	43.5 (6.5)	64.2 (4.4)	54.3 (5.2)	135	17310.00	18198.33
2300 1.6CDTi (105PS) Start/Stop	1465	1018	53.3 (5.3)	67.3 (4.2)	61.4 (4.6)	121	17595.00	18483.33
L1 H1 SPORTIVE PANEL VAN (EURO 6)								
2000 1.3CDTi (95PS)	1365	695	43.5 (6.5)	67.3 (4.2)	56.5 (5.0)	133	17395.00	18283.33
2000 1.3CDTi (95PS) Start/Stop	1365	695	52.3 (5.4)	68.9 (4.1)	61.4 (4.6)	120	17680.00	18568.33
2000 1.6CDTi (105PS) Start/Stop	1395	723	53.3 (5.3)	68.9 (4.1)	62.8 (4.5)	120	18670.00	19558.33
2300 1.3CDTi (95PS)	1395	945	43.5 (6.5)	67.3 (4.2)	56.5 (5.0)	133	17590.00	18478.33
2300 1.3CDTi (95PS) Start/Stop	1395	945	52.3 (5.4)	68.9 (4.1)	61.4 (4.6)	120	17875.00	18763.33
2300 1.6CDTi (105PS) Start/Stop	1465	973	53.3 (5.3)	67.3 (4.2)	61.4 (4.6)	121	18865.00	19753.33
L1 H2 PANEL VAN (EURO 6)								
2000 1.6CDTi (105PS) Start/Stop	1445	740	53.3 (5.3)	60.1 (4.7)	57.6 (4.9)	131	18150.00	19038.33
2300 1.6CDTi (105PS) Start/Stop	1475	1018	53.3 (5.3)	60.1 (4.7)	57.6 (4.9)	131	18345.00	19233.33
L1 H2 SPORTIVE PANEL VAN (EURO 6)								
2000 1.6CDTi (105PS) Start/Stop	1445	695	53.3 (5.3)	60.1 (4.7)	57.6 (4.9)	131	19420.00	20308.33
2300 1.6CDTi (105PS) Start/Stop	1475	973	53.3 (5.3)	60.1 (4.7)	57.6 (4.9)	131	19615.00	20503.33

Please note: On-the-road recommended retail prices (RRP) include number plates and delivery to Retailer of £583.33 (exc. VAT), 12 months' Vehicle Excise Duty at £250.00 and new vehicle first registration fee of £55.00. Excludes fuel and insurance.

* = For definitions please refer to Glossary of Terms.

= Fuel consumption information is official government environmental data, tested in accordance with the relevant EU directive. Official EU-regulated test data is provided for comparison purposes and actual performance will depend on driving style, road conditions and other non-technical factors.

COMBO PANEL VAN PRICES

BEST SMALL TRADES VAN
Vauxhall Combo 1.3CDTi
2300LH1 95ps Eu6
ecoFlex S/Stop



Model	Minimum Mass (kg)*	Payload (kg)*	Fuel economy mpg (litres/100km)#			CO ₂ emissions (g/km)#	Price (£) exc. VAT	On-the-road RRP (£) exc. VAT
			Urban driving	Extra-urban driving	Combined figure			
L2 H1 PANEL VAN (EURO 6)								
2300 1.4i (95PS) Start/Stop	1360	920	30.7 (9.2)	49.6 (5.7)	40.4 (7.0)	163	15840.00	16728.33
2300 1.3CDTi (95PS)	1460	990	42.8 (6.6)	65.7 (4.3)	55.4 (5.1)	136	17125.00	18013.33
2300 1.3CDTi (95PS) Start/Stop	1460	990	51.4 (5.5)	67.3 (4.2)	60.1 (4.7)	123	17410.00	18298.33
2300 1.6CDTi (105PS)	1505	1018	43.5 (6.5)	64.2 (4.4)	54.3 (5.2)	135	18115.00	19003.33
2300 1.6CDTi (105PS) Start/Stop	1505	1018	53.3 (5.3)	67.3 (4.2)	61.4 (4.6)	121	18400.00	19288.33
L2 H1 SPORTIVE PANEL VAN (EURO 6)								
2300 1.3CDTi (95PS)	1460	960	42.8 (6.6)	65.7 (4.3)	55.4 (5.1)	136	18210.00	19098.33
2300 1.3CDTi (95PS) Start/Stop	1460	960	51.4 (5.5)	67.3 (4.2)	60.1 (4.7)	123	18495.00	19383.33
2300 1.6CDTi (105PS) Start/Stop	1505	988	53.3 (5.3)	67.3 (4.2)	61.4 (4.6)	121	19485.00	20373.33
L2 H2 PANEL VAN (EURO 6)								
2300 1.6CDTi (105PS) Start/Stop	1535	1018	50.4 (5.6)	60.1 (4.7)	56.5 (5.0)	133	19400.00	20288.33

Please note: On-the-road recommended retail prices (RRP) include number plates and delivery to Retailer of £583.33 (exc. VAT), 12 months' Vehicle Excise Duty at £250.00 and new vehicle first registration fee of £55.00. Excludes fuel and insurance.

* = For definitions please refer to Glossary of Terms.

= Fuel consumption information is official government environmental data, tested in accordance with the relevant EU directive. Official EU-regulated test data is provided for comparison purposes and actual performance will depend on driving style, road conditions and other non-technical factors.

COMBO CREW VAN PRICES

BEST SMALL TRADES VAN
Vauxhall Combo 1.3CDTi
2300LH1 95ps Eu6
ecoFlex S/Stop



Model	Minimum Mass (kg)*	Payload (kg)*	Fuel economy mpg (litres/100km)#			CO ₂ emissions (g/km)#	Price (£) exc. VAT	On-the-road RRP (£) exc. VAT
			Urban driving	Extra-urban driving	Combined figure			
L1 H1 CREW VAN (EURO 6)								
2300 1.3CDTi (95PS)	1485	804	42.8 (6.6)	65.7 (4.3)	55.4 (5.1)	136	17120.00	18008.33
2300 1.3CDTi (95PS) Start/Stop	1485	804	51.4 (5.5)	67.3 (4.2)	60.1 (4.7)	123	17405.00	18293.33
2300 1.6CDTi (105PS)	1505	804	44.1 (6.4)	62.8 (4.5)	54.3 (5.2)	136	18110.00	18998.33
2300 1.6CDTi (105PS) Start/Stop	1505	804	54.3 (5.2)	65.7 (4.3)	61.4 (4.6)	122	18395.00	19283.33
L1 H1 SPORTIVE CREW VAN (EURO 6)								
2300 1.3CDTi (95PS)	1485	784	42.8 (6.6)	65.7 (4.3)	55.4 (5.1)	136	18205.00	19093.33
2300 1.3CDTi (95PS) Start/Stop	1485	784	51.4 (5.5)	67.3 (4.2)	60.1 (4.7)	123	18490.00	19378.33
2300 1.6CDTi (105PS) Start/Stop	1505	784	54.3 (5.2)	65.7 (4.3)	61.4 (4.6)	122	19480.00	20368.33
L2 H1 CREW VAN (EURO 6)								
2300 1.3CDTi (95PS)	1505	804	42.8 (6.6)	65.7 (4.3)	55.4 (5.1)	136	17925.00	18813.33
2300 1.3CDTi (95PS) Start/Stop	1505	804	51.4 (5.5)	67.3 (4.2)	60.1 (4.7)	123	18210.00	19098.33
2300 1.6CDTi (105PS)	1600	804	43.5 (6.5)	61.4 (4.6)	53.3 (5.3)	139	18915.00	19803.33
2300 1.6CDTi (105PS) Start/Stop	1600	804	53.3 (5.3)	64.2 (4.4)	60.1 (4.7)	125	19200.00	20088.33
L2 H1 SPORTIVE CREW VAN (EURO 6)								
2300 1.3CDTi (95PS)	1505	784	42.8 (6.6)	65.7 (4.3)	55.4 (5.1)	136	19010.00	19898.33
2300 1.3CDTi (95PS) Start/Stop	1505	784	51.4 (5.5)	67.3 (4.2)	60.1 (4.7)	123	19295.00	20183.33
2300 1.6CDTi (105PS) Start/Stop	1600	784	53.3 (5.3)	64.2 (4.4)	60.1 (4.7)	125	20285.00	21173.33

Model	Minimum Mass (kg)*	Payload (kg)*	Fuel economy mpg (litres/100km)#			CO ₂ emissions (g/km)#	Price (£) exc. VAT	On-the-road RRP (£) inc. VAT
			Urban driving	Extra-urban driving	Combined figure			
L1 H1 GLAZED CREW VAN (EURO 6)								
2300 1.3CDTi (95PS)	1485	764	42.8 (6.6)	65.7 (4.3)	55.4 (5.1)	136	17320.00	21789.00
2300 1.3CDTi (95PS) Start/Stop	1485	764	51.4 (5.5)	67.3 (4.2)	60.1 (4.7)	123	17605.00	22131.00
2300 1.6CDTi (105PS) Start/Stop	1505	764	54.3 (5.2)	65.7 (4.3)	61.4 (4.6)	122	18595.00	23319.00
L2 H1 GLAZED CREW VAN (EURO 6)								
2300 1.3CDTi (95PS)	1505	764	42.8 (6.6)	65.7 (4.3)	55.4 (5.1)	136	18125.00	22755.00
2300 1.3CDTi (95PS) Start/Stop	1505	764	51.4 (5.5)	67.3 (4.2)	60.1 (4.7)	123	18410.00	23097.00
2300 1.6CDTi (105PS) Start/Stop	1600	764	53.3 (5.3)	64.2 (4.4)	60.1 (4.7)	125	19400.00	24285.00

Please note: On-the-road recommended retail prices (RRP) include number plates and delivery to Retailer of £583.33 (exc. VAT), 12 months' Vehicle Excise Duty at £250.00 and new vehicle first registration fee of £55.00. Excludes fuel and insurance.

* = For definitions please refer to Glossary of Terms.

= Fuel consumption information is official government environmental data, tested in accordance with the relevant EU directive. Official EU-regulated test data is provided for comparison purposes and actual performance will depend on driving style, road conditions and other non-technical factors.

COMBO COLORADO PRICES

Model	Minimum Mass (kg)*	Payload (kg)*	Fuel economy mpg (litres/100km)#			CO ₂ emissions (g/km)#	Price (£) exc. VAT	On-the-road RRP (£) inc. VAT
			Urban driving	Extra-urban driving	Combined figure			
L2 H1 COLORADO CREW VAN (EURO 6)								
2300 1.3CDTi (95PS)	1505	814	42.8 (6.6)	65.7 (4.3)	55.4 (5.1)	136	19210.00	24057.00

Please note: On-the-road recommended retail prices (RRP) include number plates and delivery to Retailer of £583.33 (exc. VAT), 12 months' Vehicle Excise Duty at £250.00 and new vehicle first registration fee of £55.00. Excludes fuel and insurance.

* = For definitions please refer to Glossary of Terms.

= Fuel consumption information is official government environmental data, tested in accordance with the relevant EU directive. Official EU-regulated test data is provided for comparison purposes and actual performance will depend on driving style, road conditions and other non-technical factors.

The Combo Colorado is a fully glazed crew van without bulkhead suitable for conversion into a wheelchair accessible vehicle by a third-party Converter. The Colorado includes basic Type Approval for registration as a Category N* Commercial Vehicle and 2nd stage Type Approval must be completed by the Converter to enable registration. Available as an L2 H1 the Colorado is fitted with the highly efficient and economical 1.3CDTi (95PS) engine and includes second-row seats and interior trim.

Feature highlights:

- Type-approved for Euro 6 Category N* emissions
- Glazed between C- and D-pillars
- Air conditioning
- Two-coat metallic/brilliant paint
- Body-coloured mirrors and bumpers
- Height-adjustable driver's seat with armrest and lumbar support
- Nearside and offside side-access doors with sliding windows
- Glazed tailgate with wash/wipe facility

* = As a Category N Commercial Vehicle, the Colorado is subject to speed restrictions not applicable to a Passenger Vehicle. Please consult the DVSA website for further details.

COMBO EQUIPMENT / OPTIONS

	Combo	Sportive	Colorado	Price (£) exc. VAT
SAFETY				
Airbags:	●	●	●	
• Driver's dual-stage airbag				
• Front passenger's airbag with deactivation switch	○	○	○	235.00
Option code: AK5				
• Front passenger's airbag with deactivation switch • Driver and front passenger's side-impact airbags	○	○	○	385.00
Option code: AJ7				
Seating:	●	●	●	
• Height-adjustable head restraints				
• Active safety head restraints – <i>Front seats only.</i>	○	○	○	45.00
Option code: AJF				
Seatbelts:	●	●	●	
• Inertia-reel lap and diagonal seatbelts • Height-adjustable front seatbelts • Seatbelt pretensioner system – <i>Pretensioners tighten the seatbelt in the event of an accident limiting forward movement.</i> • Front seatbelt force limiters – <i>Reduces potential upper body injuries during a frontal impact.</i> • Seatbelt unfastened audible warning and warning light				
Body:	●	●	●	
• Laminated windscreen • Side-impact protection beams • Reinforced passenger safety cell • Fuel tank located ahead of rear axle				
Stability:	●	●	●	
Electronic Stability Programme–plus (ESP–plus) with traction control – <i>Works in conjunction with the vehicle's electronic braking and engine systems to keep the vehicle stable in many different situations. ESP monitors a variety of inputs to determine when the vehicle starts to lose traction, it can then immediately respond by varying the brake pressure between up to three wheels and adjust the engine output to help correct the loss of traction and improve stability.</i>				
Drag torque control – <i>Helps maintain stability when suddenly lifting off the accelerator.</i>				
Braking:	●	●	●	
Four-channel Anti-lock Braking System (ABS) – <i>Prevents the vehicle's wheels from locking up under heavy braking by momentarily reducing brake pressure at the appropriate wheel, ensuring that you can maintain control of the steering.</i>				
Emergency brake assist – <i>When emergency braking is detected the vehicle automatically applies the maximum possible braking assistance.</i>				
Electronic brakeforce distribution – <i>Automatically apportions the optimum braking force to each wheel.</i>				
Hill start assist – <i>Briefly maintains rear brake pressure to stop the vehicle rolling back on an incline.</i>				
Fire protection system:	●	●	●	
• Fire protection system • Fuel cut-off				

SECURITY

Features:	●	●	●	
• Electronic engine deadlock immobiliser • Steering column lock • Electronic theft protection for audio equipment				
• 'Key left in ignition' audible warning • Lockable glovebox • Lockable fuel filler cap				
Remote control door locking (doors, tailgate and fuel flap):	●	●	●	
• Remote control door locking • Folding key with integral remote • Door deadlocks				
• Alarm pre-installation kit – <i>Accessory alarm available at extra cost.</i>	○	○	○	60.00
Option code: TJD				
• Third key	○	○	○	60.00
Option code: KTN				
• Third key with remote control – <i>Panel Vans only.</i>	○	○		85.00
Option code: Z1V				

● = Standard equipment. ○ = Optional at extra cost.

COMBO EQUIPMENT / OPTIONS

COMFORT AND SEATING

	Combo	Sportive	Colorado	Price (£) exc. VAT
Comfort: • Steering column adjustable for reach and rake • Floor-mounted handbrake lever • Cube cloth seat trim • Height-adjustable front seatbelts	●	●	●	
Seating: • Reach • Backrest recline	●	●	●	
• Driver's seat height adjuster • Armrest • Lumbar support – <i>Not available with vinyl seat trim.</i>	○	●	●	Option code: DCW 75.00
• Front passenger's seat with under cushion storage compartment – <i>Panel Van only. Not available with vinyl seat trim.</i>	○	○		Option code: BA8 35.00
Rear seating – Crew Van: • Three passenger rear seat • 'Fold and tumble' facility • 60/40 split seat back and cushion	●	●	●	
Vinyl seat trim: • Black vinyl seat trim – <i>Base models only. Not available with driver's seat height adjuster or front passenger's seat with under cushion storage compartment.</i>	○			Option code: TAiB 60.00

INTERIOR CONVENIENCE

Accessory sockets: • Facia-mounted 12-volt accessory socket	●	●	●	
Interior: • Storage compartment on driver's side facia • Illuminated glovebox with lid • Door storage pockets • Dipping rear-view mirror – <i>When glazed bulkhead and glazed rear doors / tailgate are specified.</i> • Twin sunvisors, front passenger's with vanity mirror • Driver and front passenger's tiltable assist handles • Two coat hooks • Door armrests • Overhead shelf – <i>Standard on H2 and Crew Van models.</i>	●	●	●	Option code: VVM 40.00
• Rear side panel storage (fully trimmed L1, part trimmed L2) and 12-volt accessory socket – <i>Crew Van models.</i>	●	●	●	
Lighting: • Centre fade up/fade down courtesy light • Illuminated load area	●	●	●	
Load Compartment Pack: • Overhead shelf • PVC load floor covering • 12-volt accessory socket in load area • Removable load area courtesy light – <i>Panel Van only.</i>	○			Option code: LPVX 130.00
Smoker Pack: • Removable ashtray • Illuminated cigar lighter	○	○	○	Option code: DT4 55.00

DRIVER ASSISTANCE

Multi-function trip computer: • Overall distance • Trip distance • Average fuel consumption • Instantaneous fuel consumption • Vehicle range based on remaining fuel • Distance and average speed since last reset	●	●	●	
Windscreen wipers: • Two-speed windscreen wipers • Variable intermittent wipe • Electric screenwash	●	●	●	
Parking assistance: • Rear parking distance sensors • Audible warning • Distance warning graphic shown in driver information display	○	○	○	Option code: UD7 205.00
Cruise control	○	○	○	Option code: K34 185.00

● = Standard equipment. ○ = Optional at extra cost.

COMBO EQUIPMENT / OPTIONS

DRIVER INFORMATION

	Combo	Sportive	Colorado	Price (£) exc. VAT
Instrumentation: • Speedometer • Rev counter • Trip odometer • Fuel gauge with low fuel warning light • Coolant temperature warning light	●	●	●	
ECO features: • Shift-up indicator – <i>Indicates when to change gear for optimum fuel economy.</i>	●	●	●	
Driver information display: • Monochrome display located in instrument cluster • Odometer • Service-due indicator	●	●	●	
Central fascia display: • Audio information • Digital clock with automatic RDS time adjustment • Outside air temperature with ice warning function • Additional features and location dependent on infotainment unit (see Infotainment for details)	●	●	●	
Warning indicators: • Low oil level, low brake fluid, brake pad wear, battery, seatbelt reminder, airbag failure / deactivation, charging system and emission control system failure	●	●	●	

INFOTAINMENT

CD player / stereo radio: Onboard features: • CD player • AM/FM stereo radio with 24-station presets • RDS with Traffic Programme • Four speakers • 20 watts per channel output	●	●	●	
CD 50 multimedia: Onboard features: • CD/MP3 CD player • AM/FM stereo radio with 24-station presets • RDS with Traffic Programme • Four speakers • 20 watts per channel output • Steering wheel mounted audio controls Media connections: • USB connection • Aux-in socket Mobile phone portal: • Bluetooth® connectivity • Vehicle microphone Option code: UGi	○	○	○	495.00
Additional features: • Flexible roof-mounted aerial	●	●	●	

● = Standard equipment. ○ = Optional at extra cost.

COMBO EQUIPMENT / OPTIONS

HEATING AND VENTILATION

	Combo	Sportive	Colorado	Price (£) exc. VAT
Air blend heater: • Four-speed fan • Illuminated controls • Four adjustable facia vents • Windscreen demist vents • Side window demist vents	●	●	●	
Air conditioning: • Air recirculation facility • Cabin particulate filter – Removes dust, airborne particles and pollen. • Illuminated controls – Standard on Colorado models.	○	●	●	600.00 Option code: C60
Electronic climate control: • Incorporating air conditioning • Single-zone control • Six-speed fan • Advanced predictive logic control system using sun sensor • Cabin particulate filter • LCD temperature display • Automatic air direction and fan speed with manual override • Illuminated controls • Pollen filter – Mandates electrically adjustable / heated door mirrors with exterior temperature sensor at extra cost.		○	○	840.00 Option code: C68

SIDE ACCESS

Nearside access: • Nearside sliding side-access door • Unglazed – Standard on L2 H1 models.	▲	●		255.00
Offside access: • Offside sliding side-access door • Unglazed – Standard on L2 H1 models.		▲		200.00
Nearside and offside access: Side-access doors: • Nearside sliding side-access door • Unglazed • Offside sliding side-access door • Unglazed – Standard on L2 and Crew Van models.	▲			445.00
Side-access panel / doors with fixed windows: • Glazed nearside sliding side-access door • Glazed offside sliding side-access panel / door	▲	▲		300.00
Side-access doors with sliding windows: • Sliding windows to nearside sliding side-access door • Sliding window to offside sliding side-access door – Standard on Glazed Crew Van.	▲		●	

REAR ACCESS

Rear doors: • Asymmetric rear doors • Unglazed • 90°/180° opening – Not available on Glazed Crew Van / Colorado models. • Asymmetric rear doors • Glazed • 90°/180° opening • Heated windows • Wash/wipe facility – Only available when bulkhead with window is specified. Not available on non-glazed Crew Van.	●	●		
	○	○	○	155.00 Option code: J1X
Tailgate: • Glazed • Heated window • Wash/wipe facility – H1 models only. – Only available when bulkhead with window is specified. Standard on Glazed Crew Van.	○	○	●	135.00 Option code: JIU

● = Standard equipment. ○ = Optional at extra cost. ▲ = Please refer to ordering guide.

Please note: The air conditioning in vehicles with N1 type approval relies upon fluorinated greenhouse gases (R134a) for its functioning. The front system contains a quantity of overall 580g of R 134a, which corresponds to a CO₂ equivalent of 0.83 tons. The front and rear system contains a quantity of overall 890g of R 134a, which corresponds to a CO₂ equivalent of 1.27 tons. The global warming potential amounts to 1430. Information acc. to R (EU) No. 517/2014.

COMBO EQUIPMENT / OPTIONS

LOAD RESTRAINT / PROTECTION

	Combo	Sportive	Colorado	Price (£) exc. VAT
Load anchorage: • Load restraint lashing eyes – Panel Van -6, Crew Van / Colorado -4.	●	●	●	
Bulkhead: • Full-height steel bulkhead – Soundproofed on Sportive models. Not available on Crew Van / Colorado models.	●	●		
• Full-height steel bulkhead with window – Only available when glazed rear doors / tailgate are specified. Not available on Crew Van / Colorado models. Option code: AX9	○	○		60.00
• Protective ladder frame behind driver – Base Panel Van only. In lieu of full-height steel bulkhead. Only available when Load Compartment Pack is specified.	N/C			No-cost
• Full-width ladder frame bulkhead behind second-row seats – Crew Vans only.	N/C	N/C	N/C	No-cost
PVC load floor covering – Not available on Crew Van models. Option code: VT9	○	●		45.00
Carpeted load floor covering – Crew Van models.	●	●	●	
Internal ladder storage bars – Panel Van only. Not available with Load Compartment Pack or rear roof flap. Option code: S0W	○	○		165.00

EXTERIOR CONVENIENCE / STYLING









Body side-protection mouldings	●	●	●	
Body colour door mirrors and bumpers		●	●	
Windows: • Electrically operated front windows • Tinted windows	●	●	●	
Door mirrors: • Foldable door mirrors • Wide-angle mirror on driver's side	●	●	●	
• Electrically adjustable / heated door mirrors Option code: DL8	○	○	○	135.00
• Electrically adjustable / heated door mirrors • Exterior temperature sensor Option code: UGM	○	○	○	195.00
Winter Pack: • Headlight washers • Front fog lights • Exterior temperature sensor • Electrically adjustable / heated door mirrors Option code: LPW0		○		265.00
Roof rails – H1 Panel Van models only. Not available when the rear roof flap is specified. Option code: E2R	○	○		135.00
Rear roof flap – L1 H1 Panel Van models only. Only available when Load Compartment Pack is specified. Not available when roof rails or glazed tailgate options are specified. Option code: AD3	○	○		410.00

EXTERIOR LIGHTING

Standard lighting: • Halogen headlights • Daytime running lights • Lights-on audible warning • Electric headlight beam levelling • Reversing light • Hazard warning lights • Rear fog light • High-level LED centre brake light • Side-repeat indicators	●	●	●	
• Front fog lights Option code: T3U	○	○	○	115.00

● = Standard equipment. ○ = Optional at extra cost. N/C = No-cost option.

COMBO EQUIPMENT / OPTIONS





EXTERIOR COLOURS				Combo	Sportive	Colorado	Price (£) exc. VAT
	Polar White (5PU) • Solid paint		Deep Blue (4DU) • Solid paint	●	●	●	
	Tomato Red (G6Z) • Brilliant paint			○	N/C	N/C	260.00
	Magnetic Silver (2OU) • Two-coat metallic paint		Ruby Red (4VU) • Two-coat metallic paint				
	Twilight Blue (GTG) • Two-coat metallic paint		Marine Blue (4EU) • Two-coat metallic paint	○	N/C	N/C	390.00
	Midnight Black (3AU) • Two-coat metallic paint		Pepperdust (GJM) • Two-coat metallic paint				

● = Standard equipment. ○ = Optional at extra cost. N/C = No-cost option.

The colours reproduced may vary slightly from the actual paint colour. As a result they should be used as a guide only. Your Vauxhall Retailer has a comprehensive display of our paint samples.

COMBO EQUIPMENT / OPTIONS

WHEELS AND TYRES

		Combo	Sportive	Colorado	Price (£) exc. VAT
	15-inch steel wheels with centre covers – 2000 models (excluding 1.4i). • 185/65 R 15 tyres • Tyre inflation kit	●			
	15-inch steel wheels with full-diameter wheel trims – 2000 models. • 185/65 R 15 tyres • Tyre inflation kit		●		
	16-inch steel wheels with centre covers – 2300 and 1.4i models. • 195/65 R 16 tyres • Tyre inflation kit	●			
	16-inch steel wheels with full-diameter wheel trims – 2300 models. • 195/60 R 16 tyres • Tyre inflation kit		●	●	
	16-inch alloy wheels • 195/60 R 16 tyres • Tyre inflation kit • Locking wheel bolts		○		405.00
		Option code: NWQ			
Winter tyres – Goodyear Ultragrip-7: • 195/65 R 15 – 2000 models. • 195/60 R 16 – 2300 models.		○	○		235.00
Full-size spare wheel in lieu of tyre inflation kit		Option code: PHM			
		Option code: QQ5			
		N/C	N/C	N/C	No-cost

● = Standard equipment. ○ = Optional at extra cost. N/C = No-cost option.

COMBO EQUIPMENT / OPTIONS

MECHANICAL

	Combo	Sportive	Colorado	Price (£) exc. VAT	
Standard features: • Front-wheel drive • Transverse engine / gearbox	●	●	●		
Transmissions: • Five-speed manual gearbox (1.4i / 1.3CDTi models)	●	●	●		
• Six-speed manual gearbox (1.6CDTi models)	●	●	●		
Steering: • Hydraulic power-assisted rack and pinion system • Energy-absorbing steering column Turning circle: L1 11.3m (36.7ft.) L2 12.5m (41.0ft.)	●	●	●		
Brakes: Front ventilated disc brakes: • 284mm diameter (1.3CDTi / 1.6CDTi / 2000 models) • 305mm diameter (1.4i / 2300 models) Rear self-adjusting drum brakes: • 228mm diameter (1.3CDTi / 1.6CDTi) • 254mm diameter (1.4i)	●	●	●		
Fuel tank: • 60 litres (13.2 gallons) capacity	●	●	●		
Electrical: Maintenance-free battery: • 63Ah (1.4i / 1.3CDTi) • 72Ah (1.6CDTi) Alternator: • 105A (1.4i / 1.3CDTi) • 100A (1.6CDTi) • 120A – <i>Models with air conditioning.</i> • Uprated alternator	●	●	●		
	Option code: KX3	○	○	○	55.00
Front suspension: • Independent lightweight MacPherson struts • Coil springs • Telescopic gas-pressure dampers • Anti-roll bar	●	●	●		
Rear suspension: • Independent bi-link suspension • Coil springs • Gas pressure dampers • Anti-roll bar	●	●	●		

● = Standard equipment. ○ = Optional at extra cost.

TYRE RATINGS

Tyre size	Fuel efficiency group	Wet grip performance	External noise	
			Measured (dB)	Group
185/65 R 15	C-E	A-C	68-69	
195/65 R 15	C-E	C-E	68-71	
195/60 R 16	C-E	B-C	70-72	

Tyre rating according to EU Regulation 1222/2009

VIVARO PANEL VAN PRICES



Model	Minimum Mass (kg)*	Payload (kg)*	Fuel economy mpg (litres/100km)#			CO ₂ emissions (g/km)#	Price (£) exc. VAT	On-the-road RRP (£) exc. VAT
			Urban driving	Extra-urban driving	Combined figure			
L1 H1 PANEL VAN (EURO 6)								
2700 1.6CDTi (95PS) BlueInjection	1800	1060	36.2 (7.8)	48.7 (5.8)	43.4 (6.5)	170	21680.00	22568.33
2700 1.6CDTi (95PS) S/S BlueInjection	1800	1060	39.2 (7.2)	50.4 (5.6)	46.3 (6.1)	160	21875.00	22763.33
2700 1.6CDTi (120PS) BlueInjection	1800	1060	36.2 (7.8)	48.7 (5.8)	43.4 (6.5)	170	22280.00	23168.33
2700 1.6CDTi BiTurbo (125PS) S/S ecoTEC BlueInjection	1818	1062	40.9 (6.9)	51.4 (5.5)	47.0 (6.0)	155	22680.00	23568.33
2900 1.6CDTi (95PS) BlueInjection	1800	1220	36.2 (7.8)	48.7 (5.8)	43.4 (6.5)	170	22180.00	23068.33
2900 1.6CDTi (95PS) S/S BlueInjection	1800	1220	39.2 (7.2)	50.4 (5.6)	46.3 (6.1)	160	22375.00	23263.33
2900 1.6CDTi (120PS) BlueInjection	1800	1220	36.2 (7.8)	48.7 (5.8)	43.4 (6.5)	170	22780.00	23668.33
2900 1.6CDTi BiTurbo (125PS) S/S ecoTEC BlueInjection	1818	1222	40.9 (6.9)	51.4 (5.5)	47.0 (6.0)	155	23180.00	24068.33
L1 H1 SPORTIVE PANEL VAN (EURO 6)								
2700 1.6CDTi (120PS) BlueInjection	1800	1030	36.2 (7.8)	48.7 (5.8)	43.4 (6.5)	170	23480.00	24368.33
2700 1.6CDTi BiTurbo (125PS) S/S ecoTEC BlueInjection	1818	1032	40.9 (6.9)	51.4 (5.5)	47.0 (6.0)	155	23880.00	24768.33
2700 1.6CDTi BiTurbo (145PS) S/S BlueInjection	1818	1032	39.8 (7.1)	50.4 (5.6)	46.3 (6.1)	160	24680.00	25568.33
2900 1.6CDTi (120PS) BlueInjection	1800	1190	36.2 (7.8)	48.7 (5.8)	43.4 (6.5)	170	23980.00	24868.33
2900 1.6CDTi BiTurbo (125PS) S/S ecoTEC BlueInjection	1818	1192	40.9 (6.9)	51.4 (5.5)	47.0 (6.0)	155	24380.00	25268.33
2900 1.6CDTi BiTurbo (145PS) S/S BlueInjection	1818	1192	39.8 (7.1)	50.4 (5.6)	46.3 (6.1)	160	25180.00	26068.33
L1 H1 LIMITED EDITION NAV PANEL VAN (EURO 6)								
2700 1.6CDTi BiTurbo (125PS) S/S ecoTEC BlueInjection	1818	1017	40.9 (6.9)	51.4 (5.5)	47.0 (6.0)	155	25080.00	25968.33
2700 1.6CDTi BiTurbo (145PS) S/S BlueInjection	1818	1017	39.8 (7.1)	50.4 (5.6)	46.3 (6.1)	160	25880.00	26768.33
L1 H2 PANEL VAN (EURO 6)								
2900 1.6CDTi BiTurbo (125PS) S/S ecoTEC BlueInjection	1897	1143	38.7 (7.3)	43.5 (6.5)	41.5 (6.8)	175	24580.00	25468.33

Please note: On-the-road recommended retail prices (RRP) include number plates and delivery to Retailer of £583.33 (exc. VAT), 12 months' Vehicle Excise Duty at £250.00 and new vehicle first registration fee of £55.00. Excludes fuel and insurance.

S/S = Start/Stop.

Vehicles with BlueInjection technology will need regular AdBlue® top-ups also between servicing requirements. An indicator integrated into the on-board computer will warn you when you need to top up. More information under www.vauxhall.co.uk/blueinjection. In accordance with regulations R (EC) No. 715/2007 and R (EC) No. 692/2008 (in the versions respectively applicable).

* = For definitions please refer to Glossary of Terms.

= Fuel consumption information is official government environmental data, tested in accordance with the relevant EU directive. Official EU-regulated test data is provided for comparison purposes and actual performance will depend on driving style, road conditions and other non-technical factors.

VIVARO PANEL VAN PRICES



Model	Minimum Mass (kg)*	Payload (kg)*	Fuel economy mpg (litres/100km)#			CO ₂ emissions (g/km)#	Price (£) exc. VAT	On-the-road RRP (£) exc. VAT
			Urban driving	Extra-urban driving	Combined figure			
L2 H1 PANEL VAN (EURO 6)								
2900 1.6CDTi (95PS) BlueInjection	1825	1265	35.3 (8.0)	47.0 (6.0)	42.1 (6.7)	174	22980.00	23868.33
2900 1.6CDTi (95PS) S/S BlueInjection	1825	1265	38.7 (7.3)	48.7 (5.8)	44.8 (6.3)	164	23175.00	24063.33
2900 1.6CDTi (120PS) BlueInjection	1825	1265	35.3 (8.0)	47.0 (6.0)	42.1 (6.7)	174	23580.00	24468.33
2900 1.6CDTi BiTurbo (125PS) S/S ecoTEC BlueInjection	1835	1265	40.3 (7.0)	50.4 (5.6)	46.3 (6.1)	159	23980.00	24868.33
L2 H1 SPORTIVE PANEL VAN (EURO 6)								
2900 1.6CDTi (120PS) BlueInjection	1825	1235	35.3 (8.0)	47.0 (6.0)	42.1 (6.7)	174	24780.00	25668.33
2900 1.6CDTi BiTurbo (125PS) S/S ecoTEC BlueInjection	1835	1235	40.3 (7.0)	50.4 (5.6)	46.3 (6.1)	159	25180.00	26068.33
2900 1.6CDTi BiTurbo (145PS) S/S BlueInjection	1835	1235	39.2 (7.2)	48.7 (5.8)	44.8 (6.3)	164	25980.00	26868.33
L2 H1 LIMITED EDITION NAV PANEL VAN (EURO 6)								
2900 1.6CDTi BiTurbo (125PS) S/S ecoTEC BlueInjection	1835	1220	40.3 (7.0)	50.4 (5.6)	46.3 (6.1)	159	26380.00	27268.33
2900 1.6CDTi BiTurbo (145PS) S/S BlueInjection	1835	1220	39.2 (7.2)	48.7 (5.8)	44.8 (6.3)	164	27180.00	28068.33
L2 H2 PANEL VAN (EURO 6)								
2900 1.6CDTi BiTurbo (125PS) S/S ecoTEC BlueInjection	1945	1185	38.2 (7.4)	42.8 (6.6)	40.9 (6.9)	178	25380.00	26268.33

Please note: On-the-road recommended retail prices (RRP) include number plates and delivery to Retailer of £583.33 (exc. VAT), 12 months' Vehicle Excise Duty at £250.00 and new vehicle first registration fee of £55.00. Excludes fuel and insurance. S/S = Start/Stop.

Vehicles with BlueInjection technology will need regular AdBlue® top-ups also between servicing requirements. An indicator integrated into the on-board computer will warn you when you need to top up. More information under www.vauxhall.co.uk/blueinjection. In accordance with regulations R (EC) No. 715/2007 and R (EC) No. 692/2008 (in the versions respectively applicable).

* = For definitions please refer to Glossary of Terms.

= Fuel consumption information is official government environmental data, tested in accordance with the relevant EU directive. Official EU-regulated test data is provided for comparison purposes and actual performance will depend on driving style, road conditions and other non-technical factors.

VIVARO DOUBLECAB PRICES



Model	Minimum Mass (kg)*	Payload (kg)*	Fuel economy mpg (litres/100km)#			CO ₂ emissions (g/km)#	Price (£) exc. VAT	On-the-road RRP (£) exc. VAT	On-the-road RRP (£) inc. VAT
			Urban driving	Extra-urban driving	Combined figure				
L1 H1 DOUBLECAB (EURO 6)									
2900 1.6CDTi (95PS) BlueInjection	1920	974	35.3 (8.0)	47.0 (6.0)	42.1 (6.7)	174	23680.00	24568.33	29421.00
2900 1.6CDTi (95PS) S/S BlueInjection	1920	974	38.7 (7.3)	48.7 (5.8)	44.8 (6.3)	164	23875.00	24763.33	29655.00
2900 1.6CDTi (120PS) BlueInjection	1920	974	35.3 (8.0)	47.0 (6.0)	42.1 (6.7)	174	24280.00	25168.33	30141.00
2900 1.6CDTi BiTurbo (125PS) S/S ecoTEC BlueInjection	1930	974	40.3 (7.0)	50.4 (5.6)	46.3 (6.1)	159	24680.00	25568.33	30621.00
L1 H1 SPORTIVE DOUBLECAB (EURO 6)									
2900 1.6CDTi (120PS) BlueInjection	1920	934	35.3 (8.0)	47.0 (6.0)	42.1 (6.7)	174	25630.00	26518.33	31761.00
2900 1.6CDTi BiTurbo (125PS) S/S ecoTEC BlueInjection	1930	934	40.3 (7.0)	50.4 (5.6)	46.3 (6.1)	159	26030.00	26918.33	32241.00
2900 1.6CDTi BiTurbo (145PS) S/S BlueInjection	1930	934	39.2 (7.2)	48.7 (5.8)	44.8 (6.3)	164	26830.00	27718.33	33201.00
L1 H1 LIMITED EDITION NAV DOUBLECAB (EURO 6)									
2900 1.6CDTi BiTurbo (125PS) S/S ecoTEC BlueInjection	1930	919	40.3 (7.0)	50.4 (5.6)	46.3 (6.1)	159	27230.00	28118.33	33681.00
2900 1.6CDTi BiTurbo (145PS) S/S BlueInjection	1930	919	39.2 (7.2)	48.7 (5.8)	44.8 (6.3)	164	28030.00	28918.33	34641.00
L2 H1 DOUBLECAB (EURO 6)									
2900 1.6CDTi (95PS) BlueInjection	1975	1025	35.3 (8.0)	47.0 (6.0)	42.1 (6.7)	174	24480.00	25368.33	30381.00
2900 1.6CDTi (95PS) S/S BlueInjection	1975	1025	38.7 (7.3)	48.7 (5.8)	44.8 (6.3)	164	24675.00	25563.33	30615.00
2900 1.6CDTi (120PS) BlueInjection	1975	1025	35.3 (8.0)	47.0 (6.0)	42.1 (6.7)	174	25080.00	25968.33	31101.00
2900 1.6CDTi BiTurbo (125PS) S/S ecoTEC BlueInjection	1985	1025	40.3 (7.0)	50.4 (5.6)	46.3 (6.1)	159	25480.00	26368.33	31581.00
L2 H1 SPORTIVE DOUBLECAB (EURO 6)									
2900 1.6CDTi (120PS) BlueInjection	1975	985	35.3 (8.0)	47.0 (6.0)	42.1 (6.7)	174	26430.00	27318.33	32721.00
2900 1.6CDTi BiTurbo (125PS) S/S ecoTEC BlueInjection	1985	985	40.3 (7.0)	50.4 (5.6)	46.3 (6.1)	159	26830.00	27718.33	33201.00
2900 1.6CDTi BiTurbo (145PS) S/S BlueInjection	1985	985	39.2 (7.2)	48.7 (5.8)	44.8 (6.3)	164	27630.00	28518.33	34161.00
L2 H1 LIMITED EDITION NAV DOUBLECAB (EURO 6)									
2900 1.6CDTi BiTurbo (125PS) S/S ecoTEC BlueInjection	1985	970	40.3 (7.0)	50.4 (5.6)	46.3 (6.1)	159	28030.00	28918.33	34641.00
2900 1.6CDTi BiTurbo (145PS) S/S BlueInjection	1985	970	39.2 (7.2)	48.7 (5.8)	44.8 (6.3)	164	28830.00	29718.33	35601.00

Please note: On-the-road recommended retail prices (RRP) include number plates and delivery to Retailer of £583.33 (exc. VAT), 12 months' Vehicle Excise Duty at £250.00 and new vehicle first registration fee of £55.00. Excludes fuel and insurance. S/S = Start/Stop.

Vehicles with BlueInjection technology will need regular AdBlue® top-ups also between servicing requirements. An indicator integrated into the on-board computer will warn you when you need to top up. More information under www.vauxhall.co.uk/blueinjection. In accordance with regulations R (EC) No. 715/2007 and R (EC) No. 692/2008 (in the versions respectively applicable).

* = For definitions please refer to Glossary of Terms.

= Fuel consumption information is official government environmental data, tested in accordance with the relevant EU directive. Official EU-regulated test data is provided for comparison purposes and actual performance will depend on driving style, road conditions and other non-technical factors.

VAT reclaimable status requires a 1-tonne payload for Doublecabs according to HMRC. This payload calculation should take into consideration local UK Specification and Trim Level. Details enabling this determination are shown in the notes immediately below the weight tables shown in brochures and Price Guides. Ordered options may also impact available payload. Regarding VAT reclaimable status it is advisable that customers consult their local HMRC office or visit www.hmrc.co.uk for further details.

VIVARO COMBI PRICES



Model	Minimum Mass (kg)*	Payload (kg)*	Fuel economy mpg (litres/100km)#			CO ₂ emissions (g/km)#	Price (£) exc. VAT	On-the-road RRP (£) inc. VAT
			Urban driving	Extra-urban driving	Combined figure			
L1 H1 9-SEAT COMBI (EURO 6.2) – Available June 2018								
2900 1.6CDTi (120PS) S/S BlueInjection**	1872	1088	tbc	tbc	tbc	163	25293.33	31937.00
L1 H1 9-SEAT COMBI+ (EURO 6.2) – Available June 2018								
2900 1.6CDTi (120PS) S/S BlueInjection**	1936	1129	tbc	tbc	tbc	tbc	27993.33	35177.00
L2 H1 9-SEAT COMBI (EURO 6.2) – Available June 2018								
2900 1.6CDTi (120PS) S/S BlueInjection**	1913	1132	tbc	tbc	tbc	163	26093.33	32897.00
L2 H1 6-SEAT COMBI+ (EURO 6.2) – Available June 2018								
2900 1.6CDTi (120PS) S/S BlueInjection**	tbc	tbc	tbc	tbc	tbc	tbc	28793.33	36137.00

Please note: On-the-road recommended retail prices (RRP) include number plates and delivery to Retailer of £583.33 (exc. VAT), 12 months' Vehicle Excise Duty (£830.00) and new vehicle first registration fee of £55.00. Excludes fuel and insurance. S/S = Start/Stop.

Vehicles with BlueInjection technology will need regular AdBlue® top-ups also between servicing requirements. An indicator integrated into the on-board computer will warn you when you need to top up. More information under www.vauxhall.co.uk/blueinjection. In accordance with regulations R (EC) No. 715/2007 and R (EC) No. 692/2008 (in the versions respectively applicable).

* = For definitions please refer to Glossary of Terms. ** = Provisional data.

= Fuel consumption information is official government environmental data, tested in accordance with the relevant EU directive. Official EU-regulated test data is provided for comparison purposes and actual performance will depend on driving style, road conditions and other non-technical factors.

VIVARO PLATFORM CAB PRICES



Model	Minimum Mass (kg)*	Payload and Body Allowance (kg)*	Fuel economy mpg (litres/100km)#			CO ₂ emissions (g/km)#	Price (£) exc. VAT	On-the-road RRP (£) exc. VAT
			Urban driving	Extra-urban driving	Combined figure			
L2 H1 PLATFORM CAB (EURO 6)								
2900 1.6CDTi BiTurbo (125PS) S/S ecoTEC BlueInjection	1616	1474	37.7 (7.5)	42.2 (6.7)	40.4 (7.0)	181	23880.00	24768.33
2900 1.6CDTi BiTurbo (145PS) S/S BlueInjection	1616	1474	37.7 (7.5)	42.2 (6.7)	40.4 (7.0)	181	24680.00	25568.33

Please note: On-the-road recommended retail prices (RRP) include number plates and delivery to Retailer of £583.33 (exc. VAT), 12 months' Vehicle Excise Duty at £250.00 and new vehicle first registration fee of £55.00. Excludes fuel and insurance. S/S = Start/Stop.

Vehicles with BlueInjection technology will need regular AdBlue® top-ups also between servicing requirements. An indicator integrated into the on-board computer will warn you when you need to top up. More information under www.vauxhall.co.uk/blueinjection. In accordance with regulations R (EC) No. 715/2007 and R (EC) No. 692/2008 (in the versions respectively applicable).

All conversions must follow 'Vauxhall Converter Requirements' including recommended dimensional data, detailed within Part 1, available at: www.vauxhall.co.uk/conversiondata. The weight of any fitted conversion body will have to be deducted from these figures to establish actual payload and is subject to correct weight distribution. Variations from the recommended dimensions or weights may affect the vehicle's overall centre of gravity and stability. From 29 April 2013 conversion of N1 vehicles was affected by changes to type approval – for further information refer to the VCA website (N2 vehicles were affected from 29 October 2014). For further information please contact conversions@vauxhall.co.uk

* = For definitions please refer to Glossary of Terms.

= Fuel consumption information is official government environmental data, tested in accordance with the relevant EU directive. Official EU-regulated test data is provided for comparison purposes and actual performance will depend on driving style, road conditions and other non-technical factors.

All conversions must follow 'Conversion Requirements' available on: www.vauxhall.co.uk/conversiondata

VIVARO EQUIPMENT / OPTIONS

SAFETY

	Vivaro	Sportive	Limited Edition	Combi/Combi+	Price (£) exc. VAT	Total (£) inc. VAT
Airbags:						
Driver's airbag	●	●	●			
Driver and front passengers' airbag:						
• Front passengers' airbag with deactivation switch Option code: AK5	○	○	○	●	245.00	
• Driver and front passengers' curtain airbags and driver's side-impact airbag Option code: AWH	○	○	○	○	410.00	492.00
• Driver and single front passenger's curtain and side-impact airbags, front passenger's airbag with deactivation switch – Mandates single passenger seat. Option code: AYO	○	○	○	○	610.00	732.00
Stability:						
Electronic Stability Programme–plus (ESP–plus) with traction control: – Works in conjunction with the vehicle's electronic braking and engine systems to keep the vehicle stable in many different situations. ESP monitors a variety of inputs to determine when the vehicle starts to lose traction, it can then immediately respond by varying the brake pressure between up to three wheels and adjust the engine output to help correct the loss of traction and improve stability.	●	●	●	●		
Tyre pressure:						
• Tyre pressure monitoring system Option code: UJO	○	○	○	●	210.00	
Braking:						
Four-channel Anti-lock Braking System (ABS) – Prevents the vehicle's wheels from locking up under heavy braking by momentarily reducing brake pressure at the appropriate wheel, ensuring that you can maintain control of the steering.	●	●	●	●		
Emergency brake assist – When emergency braking is detected the vehicle automatically applies the maximum possible braking assistance.	●	●	●	●		
Electronic brakeforce distribution – Automatically apportions the optimum braking force to each wheel.	●	●	●	●		
Hill start assist – Briefly maintains rear brake pressure to stop the vehicle rolling back on an incline.	●	●	●	●		
Bulkhead:						
• Full-height steel bulkhead without window – Optional on Platform Cab models.	●					
• Full-height ABS plastic bulkhead with window – Doublecab only.	●	●	●			
• Full-height steel bulkhead with window Option code: AX9	○				75.00	
FlexCargo load-through bulkhead – Panel Van only:						
• Dual front passengers' seat with storage, rotating clipboard and fold-flat centre • Load-through bulkhead Option code: AYW	○	●	●		265.00	
• Dual front passengers' seat with storage, rotating clipboard and fold-flat centre • Load-through bulkhead with window Option code: AYV	○				330.00	
• Dual front passengers' seat with storage, rotating clipboard and fold-flat centre • Load-through bulkhead with window Option code: AYV		○	○		75.00	

● = Standard equipment. ○ = Optional at extra cost.

VIVARO EQUIPMENT / OPTIONS

SECURITY

	Vivaro	Sportive	Limited Edition	Combi/Combi+	Price (£) exc. VAT	Total (£) inc. VAT
Features:						
• Electronic engine deadlock immobiliser • Steering column lock • Secure fuel filler flap	●	●	●	●		
• Internal lockable rear and sliding side-access doors • Anti-theft spare wheel cradle	●	●	●	●		
Remote control door locking (features depending on body type):						
• Remote control door locking • Two keys with integral remote • Door deadlocks	●	●	●	●		
• Selective door locking • Two three-button keys with integral remote – <i>Only available with one-touch facility for electrically operated windows.</i> Option code: AUX	○	●	●	○/●	205.00	246.00
• Third key with integral remote Option code: K69	○	○	○	○	115.00	138.00
Keyless entry and start:						
• Keyless entry and start – <i>H1 models only.</i> – <i>Start/Stop models. Only available with electronic climate control (all models excluding Combi). Adds one-touch facility for electrically operated front-windows.</i> Option code: AVT	○	○	○	○/–	260.00	312.00
Security alarm system:						
• Engine compartment protection • Ultrasonic detectors in load area • Siren • Thatcham Category 1 approved (TUL3–180/0116) – <i>H1 models only. Not available on Platform Cab models.</i> Option code: XBGY	○	○	○	○	325.00	390.00

COMFORT

Comfort:						
• Height-adjustable steering wheel						
• Leather-covered steering wheel (Sportive / Limited Edition / Combi+ models)	●	●	●	●		
• Facia-mounted gear lever • Floor-mounted handbrake lever • Vinyl floor covering						
• Inertia-reel lap and diagonal seatbelts • Height-adjustable outer front seatbelts						

● = Standard equipment. ○ = Optional at extra cost.

VIVARO EQUIPMENT / OPTIONS

SEATING

	Vivaro	Sportive	Limited Edition	Combi/Combi+	Price (£) exc. VAT	Total (£) inc. VAT
Driver's seat: • Height • Reach • Backrest recline • Driver's active safety head restraint • Height-adjustable padded head restraint • Driver's seat armrest	●	●	●	●		
Dual front passengers' bench seat: • Fixed position bench seat and backrest • Height-adjustable outer front padded head restraint • Fixed centre seat padded head restraint	●			● / -		
Dual front passengers' seat with underseat storage • Fixed position bench seat and backrest • Height-adjustable outer front padded head restraint • Fixed centre seat padded head restraint – <i>Doublecab / Combi models.</i> Option code: AGE	○	●	●	○ / ●	175.00	210.00
Single front passenger's seat: • Lumbar adjustment • Height • Reach • Backrest recline • Height-adjustable padded head restraint • Armrest – <i>Sportive / Limited Edition Panel Van models will be supplied with full-height steel bulkhead when this option is specified.</i> Option code: AGD	○	○	○	○	155.00	186.00
Heated front seats: • Electrically heated driver and single front passenger seats – <i>Only available with either single front passenger seat and curtain airbags / side-impact airbag options.</i> Option code: KA1	○	○	○	○	160.00	192.00
Seat trim: • Blue Tricess cloth seat trim	●			● / -		
• Black Connect embossed cloth seat trim		●	●	- / ●		
• Eco-Leather seat trim – <i>1.25mm thick Microfibre featuring improved anti-tear / scratch, acid / alkali and light resistance, making it a better choice for the environment of a commercial vehicle</i> • Driver and single front passenger seat (2 seats) – Panel Van – <i>Only available when single front passenger seat is specified.</i> Option code: XIEQ		○	○		540.00	
• Eco-Leather seat trim – <i>1.25mm thick Microfibre featuring improved anti-tear / scratch, acid / alkali and light resistance, making it a better choice for the environment of a commercial vehicle</i> • Driver and dual front passenger bench seat (3 seats) – Panel Van Option code: XIER		○	○		720.00	
• Eco-Leather seat trim – <i>1.25mm thick Microfibre featuring improved anti-tear / scratch, acid / alkali and light resistance, making it a better choice for the environment of a commercial vehicle</i> • Driver, single front passenger and rear bench seat (5 seats) – Doublecab – <i>Only available when single front passenger seat is specified.</i> Option code: XIES		○	○		1125.00	
• Eco-Leather seat trim – <i>1.25mm thick Microfibre featuring improved anti-tear / scratch, acid / alkali and light resistance, making it a better choice for the environment of a commercial vehicle</i> • Driver, dual front passenger and rear bench seat (6 seats) – Doublecab Option code: XIET		○	○		1323.00	

● = Standard equipment. ○ = Optional at extra cost.

VIVARO EQUIPMENT / OPTIONS

REAR SEATING

	Vivaro	Sportive	Limited Edition	Combi/Combi+	Price (£) exc. VAT	Total (£) inc. VAT
Doublecab second-row seating:						
• Three-individually contoured rear seats • Inertia-reel lap and diagonal seatbelts	●	●	●			
• Padded head restraints						
• Underseat storage • 12-volt accessory socket		●	●			
Combi second-row seating:						
• Three-passenger removable bench seat				●		
• 60/40 split-folding seat back for easier access to third-row bench seat						
• Height-adjustable padded head restraints • Inertia-reel lap and diagonal seatbelts						
Combi third-row seating:						
• Three-passenger bench seat • Height-adjustable padded head restraints				●		
• Fold and tumble feature for creating extra load area without removing seats						
• Removable rear seats • Inertia-reel lap and diagonal seatbelts • Armrests						

CABIN STORAGE

Accessory sockets:						
• Facia-mounted 12-volt accessory socket	●	●	●	●		
Facia storage:						
• Nine facia storage spaces offering more than 24 litres of storage	●	●	●	●		
• Storage compartment with lid above glovebox (no lid on Platform Cab models)						
• Illuminated glovebox • Three drinks holders • Coin holder						
Front door pockets:						
• Large door pockets with drinks holder	●	●	●	●		

● = Standard equipment.

VIVARO EQUIPMENT / OPTIONS

DRIVER ASSISTANCE

	Vivaro	Sportive	Limited Edition	Combi/Combi+	Price (£) exc. VAT	Total (£) inc. VAT
Windscreen wipers: • Two-speed windscreen wipers • Variable intermittent wipe • Electric screenwash	●	●	●	●		
Multi-function trip computer: • Trip odometer • Vehicle range based on remaining fuel • Average speed • Average fuel economy • Instantaneous fuel economy • Driving time	●	●	●	●		
Parking assistance: • Rear parking distance sensors Option code: UD7	○	●	●	○	235.00	282.00
• Rear-view camera – H1 models only. Not available on Platform Cab models. – Requires Sight and Light Pack (Sportive models). Option code: UDS		○	○		295.00	
• Rear-view camera • Rear parking distance sensors – H1 models only. Not available on Platform Cab models. – Requires Lighting Pack / Sight and Light Pack. Option code: UDS	○			○	520.00	624.00
• Nearside blind-spot / junction mirror located in front passenger sunvisor	●	●	●	●		
Cruise control, speed limiter Option code: K34	○	●	●	○/●	260.00	312.00
Speed limiter – These are factory-fitted speed limiters that cannot be adjusted by driver: • Choice of three speeds: 56mph / 62mph / 68mph Option code: KYJ (56mph) Option code: KYK (62mph) Option code: KYL (68mph)	○	○	○	○	85.00	102.00

● = Standard equipment. ○ = Optional at extra cost.

VIVARO EQUIPMENT / OPTIONS

DRIVER INFORMATION

	Vivaro	Sportive	Limited Edition	Combi/Combi+	Price (£) exc. VAT	Total (£) inc. VAT
Instrumentation: • Speedometer • Rev counter • Fuel gauge with low fuel warning light • Fuel economy gauge • Coolant temperature warning light	●	●	●	●		
ECO features: • Shift-up indicator – Indicates when to change gear for optimum fuel economy.	●	●	●	●		
Driver information display: • Monochrome display located in instrument cluster • Odometer • Service-due indicator • Displays trip computer data	●	●	●	●		
Central fascia display: • Audio information • Digital clock with automatic RDS time adjustment • Outside air temperature with ice warning function • Additional features and location dependent on infotainment unit (see Audio, Communication and Navigation for details)	●	●	●	●		
Warning indicators: • Low oil level, low brake fluid, brake pad wear, battery, fuel filter, low AdBlue® level, seatbelt warning and doors open	●	●	●	●		
Digital tachograph: • Odometer display is changed from miles to kilometres – Digital tachograph only available with R 16 audio unit. – Important: The digital tachograph must be specified at time of ordering as it cannot be fitted retrospectively. Option price does not include calibration which must be carried out at an approved tachograph centre within 14 days of the vehicle's registration. Please note: The legislation regarding the use of tachographs is complex and operators should seek independent advice or speak to the Commercial Vehicle specialist at your Vauxhall retailer to ensure compliance. Alternatively your local DVLA office will also be able to provide clarification of the relevant legislation.	○			○	535.00	642.00
						Option code: TGP

PACKS

Navigation Pack: • Satellite navigation – NAVI 50 IntelliLink. • Rear parking distance sensors • Rear-view camera • One-touch electrically operated front windows • Three-button key • Selective door locking – H1 models only. Not available on Platform Cab models. Requires Lighting Pack / Sight and Light Pack.	○			○	1005.00	1206.00
						Option code: OEC
Navigation Pack: • Satellite navigation – NAVI 50 IntelliLink. • Rear-view camera – Requires Sight and Light Pack.		○			860.00	
						Option code: OEC

● = Standard equipment. ○ = Optional at extra cost.

VIVARO EQUIPMENT / OPTIONS

INFOTAINMENT

	Vivaro	Sportive	Limited Edition	Combi/Combi+	Price (£) exc. VAT	Total (£) inc. VAT
R 16 BT USB: Onboard features: • DAB digital radio • AM/FM stereo radio with 6-station presets • RDS with Traffic Programme • Two speakers – Four on Combi models. • 20 watts per channel output Media connections: • USB connection with iPod control • Aux-in socket • Bluetooth® audio streaming (A2DP Profile) Mobile phone portal: • Bluetooth® connectivity • Handsfree calls via steering wheel controls • Vehicle microphone • Phone book access – Contacts / last calls / missed calls etc. (features dependent on mobile phone).	●	N/C	N/C	●		
CD 18 BT USB: Onboard features: • DAB digital radio • AM/FM stereo radio with 6-station presets • CD/MP3 CD player • RDS with Traffic Programme • Two Speakers – Four on Combi models • 20 watts per channel output Media connections: • USB connection with iPod control • Aux-in socket • Bluetooth® audio streaming (A2DP Profile) Mobile phone portal: • Bluetooth® connectivity • Handsfree calls via steering wheel controls • Vehicle microphone • Phone book access – Contacts / last calls / missed calls etc. (features dependent on mobile phone). Option code: 2L2		●				
NAVI 50 IntelliLink – Not available when tachograph is specified: Onboard features: • DAB digital radio • AM/FM stereo radio with 18-station presets • 7-inch facia-mounted colour touchscreen • RDS with Traffic Programme • Two speakers – Four on Combi models. • 20 watts per channel output Navigation features: • Satellite navigation system • 3D street level mapping • Major route mapping for Western Europe Media connections: • USB connection with iPod control • Aux-in socket • Bluetooth® audio streaming (A2DP Profile) • Siri voice control Mobile phone portal: • Bluetooth® connectivity • Handsfree calls via steering wheel controls • Vehicle microphone • Phone book access – Contacts / last calls / missed calls etc. are mirrored on the display and are easily navigated using the touchscreen (features dependent on mobile phone). Option code: 10P	○	○	●	○	660.00	792.00
NAVI 80 IntelliLink – Only available in conjunction with cruise control. Not available when tachograph is specified: Onboard features: • DAB digital radio • AM/FM stereo radio with 18-station presets • 7-inch facia-mounted colour touchscreen • RDS with Traffic Programme • Two speakers – Four on Combi models. • 20 watts per channel output Navigation features: • Satellite navigation system • TomTom LIVE services (inclusive subscription for TomTom LIVE ends 31 December 2020, and cannot be renewed) • 3D street level mapping • Major route mapping for Europe • Traffic Information Media connections: • USB connection with iPod control • Aux-in socket • Bluetooth® audio streaming (A2DP Profile) • Integrated voice control Mobile phone portal: • Bluetooth® connectivity • Handsfree calls via steering wheel controls • Vehicle microphone • Phone book access – Contacts / last calls / missed calls etc. are mirrored on the display and are easily navigated using the touchscreen (features dependent on mobile phone). Option code: 2L9	○	○	○	○	1080.00	1296.00

● = Standard equipment. ○ = Optional at extra cost. N/C = No-cost option.

VIVARO EQUIPMENT / OPTIONS

INFOTAINMENT

	Vivaro	Sportive	Limited Edition	Combi/Combi+	Price (£) exc. VAT	Total (£) inc. VAT
Flexdock for smartphone / tablet:						
• Universal smartphone docking station (up to 4.7-inch) Option code: UV8	○	○	●	○	50.00	60.00
• Tablet docking station (up to 4.8 – 10.6 inch) – <i>Only available with R 16 audio unit.</i> Option code: B8L	○			○/–	70.00	84.00
Additional features:						
• Steering column mounted audio controls • Flexible roof-mounted aerial	●	●	●	●		

HEATING AND VENTILATION

Cab heating:						
• Four-speed fan • Illuminated controls • Four adjustable facia vents • Windscreen demist vents • Side window demist vents	●	●	●	●		
Climate and Cruise Pack:						
• Air conditioning with air recirculation facility (cab only) • CD 18 BT USB audio unit • Cruise control Option code: XAEB	○			○/–	770.00	924.00
Air conditioning – Cab only:						
• Air recirculation facility • Pollen filter • Illuminated controls • Chilled glovebox facility Option code: C60	○	●	●	○/–	750.00	900.00
Electronic climate control:						
• Incorporating air conditioning • LCD temperature display • Automatic air direction and fan speed with manual override • Illuminated controls • Pollen filter • Chilled glovebox facility – <i>Requires Lighting Pack.</i> Option code: C68	○				890.00	
Electronic climate control:						
• LCD temperature display • Automatic air direction and fan speed with manual override • Illuminated controls • Pollen filter • Chilled glovebox facility – <i>Requires Sight and Light Pack.</i> Option code: C68		○	○		260.00	
Air conditioning – Cab and saloon:						
• Air recirculation facility • Pollen filter • Illuminated controls • Chilled glovebox facility • Auxiliary heating ducts Option code: CJ5				○/●		1272.00

● = Standard equipment. ○ = Optional at extra cost.

Please note: The air conditioning in vehicles with N1 type approval relies upon fluorinated greenhouse gases (R134a) for its functioning. The front system contains a quantity of overall 580g of R 134a, which corresponds to a CO₂ equivalent of 0.83 tons. The front and rear system contains a quantity of overall 890g of R 134a, which corresponds to a CO₂ equivalent of 1.27 tons. The global warming potential amounts to 1430. Information acc. to R (EU) No. 517/2014.

VIVARO EQUIPMENT / OPTIONS

LOAD ACCESS

	Vivaro	Sportive	Limited Edition	Combi/Combi+	Price (£) exc. VAT	Total (£) inc. VAT
Illuminated load / saloon area	●	●	●	●		
Nearside access – Panel Van only:						
Nearside side-access door:						
• Nearside sliding side-access door • Unglazed	●	●	●			
Offside access – Panel Van only:						
Offside side-access door:						
• Offside sliding side-access door • Unglazed	○	○	○		300.00	
Option code: BSJ						
Nearside and offside access:						
Side-access doors with fixed windows – Standard on Doublecab:						
• Fixed window to standard nearside side-access door • Offside side-access door	○	○	○	● / –	380.00	
• Fixed window to offside side-access door						
Option code: BSB						
Side-access doors with sliding windows – Panel Van models. Only available with glazed rear doors / tailgate:						
• Sliding window to standard nearside side-access door • Offside side-access door	○	○	○		430.00	
• Sliding window to offside side-access door						
Option code: BSC						
Side-access doors with sliding windows – Doublecab / Combi models:						
• Sliding window to standard glazed nearside side-access door	○	○	○	○ / ●	60.00	72.00
• Sliding window to standard glazed offside side-access door						
Option code: BSC						
Rear access:						
Rear solid doors:						
• Twin rear doors • 90°/180° opening	●	●	●			
• Twin rear doors • 270° opening – Not available on L1 models.						
Option code: 7U4	○	○	○		250.00	
Rear glazed doors:						
• Glazed rear doors • 90°/180° opening – Only available with glazed bulkhead options.	○	○	○	○	85.00	102.00
• Glazed tailgate – Not available on H2 models. Only with glazed bulkhead and heated rear windows with wash/wipe facility options.	○	○	○	●	120.00	
• Heated rear windows with wash/wipe facility – Only with glazed rear door and tailgate options.	○	○	○	●	60.00	
Option code: C25						

● = Standard equipment. ○ = Optional at extra cost.

VIVARO EQUIPMENT / OPTIONS

LOAD RESTRAINT

	Vivaro	Sportive	Limited Edition	Combi/Combi+	Price (£) exc. VAT	Total (£) inc. VAT
Load anchorage:						
• Fixed floor-mounted load restraint lashing eyes	●	●	●			
Load lining:						
• Full-height coated wooden load lining panels – <i>H1 Panel Van only.</i> Option code: ERK	○	○	○		310.00	
• Full-height light plastic honeycomb load lining panels – <i>H1 only.</i> Option code: B6H	○	○	○		305.00	
• Resin-coated laminate plywood load floor covering – <i>H1 only.</i> Option code: B68	○	○	○		345.00	
• Resin-coated laminate plywood wheel arch protection – <i>H1 only.</i> Option code: B65	○	○	○		210.00	

EXTERIOR LIGHTING

Standard lighting:						
• Lights-on audible warning • Electric headlight beam levelling • Twin reversing lights • Hazard warning lights • Rear fog lights • High-level brake light • High-level tail lights • Side-repeat indicators • Daytime running lights – <i>LED on Sportive / Limited Edition models.</i>	●	●	●	●		
• Front fog lights – <i>Chrome surround on Limited Edition models.</i> Option code: T3U	○	●	●	○/●	120.00	144.00
Lighting Pack:						
• Static cornering lights • Front fog lights • Automatic lighting control • Rain-sensitive windscreen wipers • Door-to-door illumination Option code: XAEG	○			○/–	260.00	312.00
Sight and Light Pack:						
• Automatic lighting control • Rain-sensitive windscreen wipers Option code: 5BT		○	●	–/○	245.00	294.00

● = Standard equipment. ○ = Optional at extra cost.

VIVARO EQUIPMENT / OPTIONS





EXTERIOR CONVENIENCE / STYLING

	Vivaro	Sportive	Limited Edition	Combi/Combi+	Price (£) exc. VAT	Total (£) inc. VAT
Exterior features: • Unique styled graphics – <i>Black or silver dependent on exterior colour. Please see Exterior Colours page.</i>			●			
Appearance Pack One: • Body-colour front bumper • Body-colour rear quarter bumpers – <i>H2 models are only available when Glacier White or Platinum Silver colours are specified.</i> Option code: 5LK	○			○/–	310.00	372.00
Appearance Pack - Sportive: • Body-colour front bumper • Chrome-effect front grille • Body-colour rear and rear quarter bumpers • Body-colour side-protection mouldings • Body-colour mirror housings and sliding door rail cover • Body-colour D pillar and light surrounds Option code: 5LS		○			310.00	
Windows: • Electrically operated front windows	●	●	●	●		
• One-touch facility for electrically operated windows Option code: AXG	○	●	●	○/●	50.00	60.00
• Dark-tinted rear glazing – <i>H1 models only. Only available with glazed rear doors / tailgate with heated windows and wash / wipe facility. – Excludes Platform Cab.</i> Option code: AJS	○	○	○	○/●	360.00	432.00
Door mirrors: • Foldable electrically adjustable/heated door mirrors • Wide-angle mirror on driver's side	●	●	●	●		
Paint finish: • Special paint – <i>Restrictions apply, please consult your Retailer for details.</i>	○			○/–	At extra cost	

● = Standard equipment. ○ = Optional at extra cost.

VIVARO EQUIPMENT / OPTIONS

EXTERIOR COLOURS







		Vivaro	Sportive	Limited Edition	Combi/Combi+	Price (£) exc. VAT	Total (£) inc. VAT
	Glacier White (10U) • Solid paint • Black alloy wheels / graphics on Limited Edition models	●	●	●	●		
	Flame Red (79U / 79Z) • Brilliant paint • Black or silver alloy wheels / graphics on Limited Edition models						
	Spring Green (10G / 10Z) • Brilliant paint • Black alloy wheels / graphics on Limited Edition models	○	N/C	N/C	○	320.00	384.00
	Iron Grey (10D) • Brilliant paint • Silver alloy wheels / graphics on Limited Edition models						

● = Standard equipment. ○ = Optional at extra cost. N/C = No-cost option.

The colours reproduced may vary slightly from the actual paint colour. As a result they should be used as a guide only. Your Vauxhall Retailer has a comprehensive display of our paint samples.

VIVARO EQUIPMENT / OPTIONS

EXTERIOR COLOURS





		Vivaro	Sportive	Limited Edition	Combi/Combi+	Price (£) exc. VAT	Total (£) inc. VAT
	Panorama Blue (4UU) • Two-coat metallic paint • Silver alloy wheels / graphics on Limited Edition models						
	Midnight Black (92U) • Two-coat metallic paint • Silver alloy wheels / graphics on Limited Edition models						
	Cassiopeia Silver (10J) • Two-coat metallic paint • Silver alloy wheels / graphics on Limited Edition models	○	N/C	N/C	○	450.00	540.00
	Copper Brown (10K) • Two-coat metallic paint • Silver alloy wheels / graphics on Limited Edition models						
	Jasper Brown (10E) • Two-coat metallic paint • Silver alloy wheels / graphics on Limited Edition models						
	Platinum Silver (10H) • Two-coat metallic paint • Black alloy wheels / graphics on Limited Edition models						

○ = Optional at extra cost. N/C = No-cost option.

The colours reproduced may vary slightly from the actual paint colour. As a result they should be used as a guide only. Your Vauxhall Retailer has a comprehensive display of our paint samples.

VIVARO EQUIPMENT / OPTIONS

WHEELS AND TYRES

	Vivaro	Sportive	Limited Edition	Combi/Combi+	Price (£) exc. VAT	Total (£) inc. VAT
 <p>16-inch steel wheels with centre cap:</p> <ul style="list-style-type: none"> • 205/65 R 16 tyres (1.6CDTi 95/120/125PS engines) • 215/65 R 16 tyres (1.6CDTi 145PS engines) • Full-size spare wheel 	●					
 <p>16-inch steel wheels with wheel trims:</p> <ul style="list-style-type: none"> • 205/65 R 16 tyres (1.6CDTi 95/120/125PS engines) • 215/65 R 16 tyres (1.6CDTi 145PS engines) • Full-size spare wheel 		●		●		
 <p>17-inch black alloy wheels:</p> <ul style="list-style-type: none"> • 215/60 R 17 tyres • 16-inch steel spare wheel – On Limited Edition models, wheel finish dependent on body colour. Please see Exterior Colours page. 			●			
 <p>17-inch silver alloy wheels:</p> <ul style="list-style-type: none"> • 215/60 R 17 tyres • 16-inch steel spare wheel – Not available on H2 or Platform Cab models. – On Limited Edition models, wheel finish dependent on body colour. Please see Exterior Colours page. 	○	○	●		630.00	756.00
<p>Option code: RS6</p>						
<p>All-season tyres:</p> <ul style="list-style-type: none"> • 205/65 R 16 (All engines) 	○	○			215.00	258.00
<p>Option code: NRK</p>						
<p>Tyre inflation kit in lieu of spare wheel – Not available on L2 Combi models.</p>	N/C	N/C	N/C	N/C / ●	No-cost option	
<p>Option code: WTC</p>						

● = Standard equipment. ○ = Optional at extra cost. N/C = No-cost option.

VIVARO EQUIPMENT / OPTIONS

MECHANICAL	Vivaro	Sportive	Limited Edition	Combi/Combi+	Price (£) exc. VAT	Total (£) inc. VAT
Transmission: Six-speed manual gearbox: • Front-wheel drive • Transverse engine/gearbox	●	●	●	●		
Steering: • Hydraulic power-assisted rack and pinion system • Energy absorbing steering column Turning circles Kerb-to-kerb FWD L1 11.8m (38.7ft.) FWD L2 13.2m (43.3ft.)	●	●	●	●		
Brakes: Front ventilated disc brakes: • 296mm x 28mm Rear disc brakes: • 280mm x 12mm	●	●	●	●		
Power take-off • Engine driven power take-off • Six-pin / two-pin connector for conversions	○	○	○		220.00	
Fuel tank: • 80 litres (17.6 gallons) capacity	●	●	●	●		
AdBlue® tank: • 22 litres (4.8 gallons) capacity	●	●	●	●		
Towing: • Tow bar with 13-pin electrics • Trailer stability programme <i>– Excludes Platform Cab models. Does not suit trailers with LED lights. For trailers with LED lights use genuine Vauxhall Accessory tow bars which also include trailer stability programme. Unless specific exemptions apply, vehicles operated with a trailer, where the combined weight of the vehicle, trailer and payload exceeds 3500kg, require a digital tachograph.</i>	○	○	○		325.00	390.00
Electrical: • 80Ah maintenance-free battery (70Ah on air conditioned models) • 185A alternator (150A on air conditioned models) • Second battery	●	●	●	●		
	○				510.00	
CANbus interface: <i>Allows the vehicle's electrical systems to integrate with additional equipment.</i>	○	○	○	○	135.00	162.00
Six-pin / two pin electrical connector for conversions	○	○	○	○	60.00	72.00
Vehicle tracking: <i>A supplementary vehicle enhancement applied and supported by Masternaut as a 3rd Party Converter. This enhancement does not include Aftersales support. The enhancement is reversible. The telematics services are provided by Masternaut Limited ('Masternaut') and are subject to the end-user terms of Masternaut. Masternaut is an independent technology service provider. Vauxhall is not provider and not responsible for the telematics services offered by Masternaut.</i>						
• Telematic box – Base	○	○	○	○	215.00	258.00
• Telematic box – Premium	○	○	○	○	280.00	336.00
Front suspension: • MacPherson type • Independent double wishbones • Coil springs • Gas-pressure dampers	●	●	●	●		
Rear suspension: • Independent four-link, progressive-rate mini-block springs • Gas-pressure dampers	●	●	●	●		

● = Standard equipment. ○ = Optional at extra cost.

MOVANO PANEL VAN PRICES

BEST HEAVY VAN
 Vauxhall Movano 3500
 L2H2 FWD Eu6
 BiTurbo 145ps Eu6



Model	Minimum Mass (kg)*	Payload (kg)*	Fuel economy mpg (litres/100km)#			CO ₂ emissions (g/km)#	Price (£) exc. VAT	On-the-road RRP (£) exc. VAT
			Urban driving	Extra-urban driving	Combined figure			
L1 H1 FWD PANEL VAN (EURO 6)								
2800 2.3CDTi (110PS) BlueInjection	1927	858	32.1 (8.8)	40.4 (7.0)	36.7 (7.7)	201	24645.00	25533.33
2800 2.3CDTi (130PS) BlueInjection	1927	858	32.1 (8.8)	40.4 (7.0)	36.7 (7.7)	201	25445.00	26333.33
3300 2.3CDTi (110PS) BlueInjection	1932	1353	32.1 (8.8)	40.4 (7.0)	36.7 (7.7)	201	25895.00	26783.33
3300 2.3CDTi (130PS) BlueInjection	1932	1353	32.1 (8.8)	40.4 (7.0)	36.7 (7.7)	201	26695.00	27583.33
3500 2.3CDTi (110PS) BlueInjection	1937	1548	32.1 (8.8)	40.4 (7.0)	36.7 (7.7)	201	26545.00	27433.33
3500 2.3CDTi (130PS) BlueInjection	1937	1548	32.1 (8.8)	40.4 (7.0)	36.7 (7.7)	201	27345.00	28233.33
3500 2.3CDTi BiTurbo (145PS) S/S BlueInjection	1946	1539	38.2 (7.4)	42.8 (6.6)	40.9 (6.9)	179	28455.00	29343.33
L1 H2 FWD PANEL VAN (EURO 6)								
2800 2.3CDTi (110PS) BlueInjection	1955	830	31.7 (8.9)	39.8 (7.1)	36.2 (7.8)	204	25245.00	26133.33
2800 2.3CDTi (130PS) BlueInjection	1955	830	31.7 (8.9)	39.8 (7.1)	36.2 (7.8)	204	26045.00	26933.33
3300 2.3CDTi (110PS) BlueInjection	1960	1325	31.7 (8.9)	39.8 (7.1)	36.2 (7.8)	204	26495.00	27383.33
3300 2.3CDTi (130PS) BlueInjection	1960	1325	31.7 (8.9)	39.8 (7.1)	36.2 (7.8)	204	27295.00	28183.33
3500 2.3CDTi (110PS) BlueInjection	1965	1520	31.7 (8.9)	39.8 (7.1)	36.2 (7.8)	204	27145.00	28033.33
3500 2.3CDTi (130PS) BlueInjection	1965	1520	31.7 (8.9)	39.8 (7.1)	36.2 (7.8)	204	27945.00	28833.33
3500 2.3CDTi BiTurbo (145PS) S/S BlueInjection	1974	1511	37.2 (7.6)	42.2 (6.7)	40.4 (7.0)	183	29055.00	29943.33
L2 H2 FWD PANEL VAN (EURO 6)								
3300 2.3CDTi (110PS) BlueInjection	2004	1281	31.7 (8.9)	39.8 (7.1)	36.2 (7.8)	204	27850.00	28738.33
3300 2.3CDTi (130PS) BlueInjection	2004	1281	31.7 (8.9)	39.8 (7.1)	36.2 (7.8)	204	28650.00	29538.33
3500 2.3CDTi (110PS) BlueInjection	2009	1476	31.7 (8.9)	39.8 (7.1)	36.2 (7.8)	204	28500.00	29388.33
3500 2.3CDTi (110PS) S/S BlueInjection	2009	1476	34.9 (8.1)	39.8 (7.1)	37.7 (7.5)	194	28790.00	29678.33
3500 2.3CDTi (130PS) BlueInjection	2009	1476	31.7 (8.9)	39.8 (7.1)	36.2 (7.8)	204	29300.00	30188.33
3500 2.3CDTi BiTurbo (145PS) S/S BlueInjection	2018	1467	37.2 (7.6)	42.2 (6.7)	40.4 (7.0)	183	30410.00	31298.33
3500 2.3CDTi BiTurbo (170PS) S/S Tecshift BlueInjection	2018	1467	36.2 (7.8)	40.9 (6.9)	39.2 (7.2)	187	32535.00	33423.33
L2 H3 FWD PANEL VAN (EURO 6)								
3500 2.3CDTi (110PS) BlueInjection	2050	1435	31.7 (8.9)	39.8 (7.1)	36.2 (7.8)	204	29200.00	30088.33
3500 2.3CDTi (130PS) BlueInjection	2050	1435	31.7 (8.9)	39.8 (7.1)	36.2 (7.8)	204	30000.00	30888.33
3500 2.3CDTi BiTurbo (145PS) S/S BlueInjection	2059	1426	37.2 (7.6)	42.2 (6.7)	40.4 (7.0)	183	31110.00	31998.33
3500 2.3CDTi BiTurbo (170PS) S/S Tecshift BlueInjection	2059	1426	36.2 (7.8)	40.9 (6.9)	39.2 (7.2)	187	33235.00	34123.33

Please note: On-the-road recommended retail prices (RRP) include number plates and delivery to Retailer of £583.33 (exc. VAT), 12 months' Vehicle Excise Duty at £250.00 and new vehicle first registration fee of £55.00. Excludes fuel and insurance.

S/S = Start/Stop.

Vehicles with BlueInjection technology will need regular AdBlue® top-ups also between servicing requirements. An indicator integrated into the on-board computer will warn you when you need to top up. More information under www.vauxhall.co.uk/blueinjection. In accordance with regulations R (EC) No. 715/2007 and R (EC) No. 692/2008 (in the versions respectively applicable).

* = For definitions please refer to Glossary of Terms.

= Fuel consumption information is official government environmental data, tested in accordance with the relevant EU directive. Official EU-regulated test data is provided for comparison purposes and actual performance will depend on driving style, road conditions and other non-technical factors.

MOVANO PANEL VAN PRICES

BEST HEAVY VAN
Vauxhall Movano 3500
L2H2 FWD Eu6
BiTurbo 145ps Eu6



Model	Minimum Mass (kg)*	Payload (kg)*	Fuel economy mpg (litres/100km)#			CO ₂ emissions (g/km)#	Price (£) exc. VAT	On-the-road RRP (£) exc. VAT
			Urban driving	Extra-urban driving	Combined figure			
L3 H2 FWD PANEL VAN (EURO 6)								
3500 2.3CDTi (110PS) BlueInjection	2090	1395	31.4 (9.0)	39.2 (7.2)	35.8 (7.9)	207	29200.00	30088.33
3500 2.3CDTi (110PS) S/S BlueInjection	2090	1395	34.4 (8.2)	39.2 (7.2)	37.2 (7.6)	197	29490.00	30378.33
3500 2.3CDTi (130PS) BlueInjection	2090	1395	31.4 (9.0)	39.2 (7.2)	35.8 (7.9)	207	30000.00	30888.33
3500 2.3CDTi BiTurbo (145PS) S/S BlueInjection	2099	1386	36.2 (7.8)	41.5 (6.8)	39.2 (7.2)	186	31110.00	31998.33
3500 2.3CDTi BiTurbo (170PS) S/S BlueInjection	2099	1386	36.7 (7.7)	40.4 (7.0)	38.7 (7.3)	189	32360.00	33248.33
3500 2.3CDTi BiTurbo (170PS) S/S Tecshift BlueInjection	2099	1386	35.8 (7.9)	40.4 (7.0)	38.7 (7.3)	189	33235.00	34123.33
L3 H3 FWD PANEL VAN (EURO 6)								
3500 2.3CDTi (110PS) BlueInjection	2130	1355	31.4 (9.0)	39.2 (7.2)	35.8 (7.9)	207	29900.00	30788.33
3500 2.3CDTi (130PS) BlueInjection	2130	1355	31.4 (9.0)	39.2 (7.2)	35.8 (7.9)	207	30700.00	31588.33
3500 2.3CDTi BiTurbo (145PS) S/S BlueInjection	2139	1346	36.2 (7.8)	41.5 (6.8)	39.2 (7.2)	186	31810.00	32698.33
L3 H2 RWD PANEL VAN (EURO VIc)								
3500 2.3CDTi BiTurbo (130PS) BlueInjection	2356	1129	30.4 (9.3)	32.5 (8.7)	31.4 (9.0)	232	31300.00	32188.33
3500 2.3CDTi BiTurbo (145PS) S/S BlueInjection	2356	1129	34.4 (8.2)	34.9 (8.1)	34.4 (8.2)	212	32410.00	33298.33
3500 HD 2.3CDTi BiTurbo (130PS) BlueInjection	2375	1110	29.4 (9.6)	30.7 (9.2)	30.4 (9.3)	242	31900.00	32788.33
3500 HD 2.3CDTi BiTurbo (145PS) S/S BlueInjection	2375	1110	33.2 (8.5)	32.8 (8.6)	32.8 (8.6)	222	33010.00	33898.33
4500 HD 2.3CDTi BiTurbo (130PS) Tacho BlueInjection	2375	2110	N/A (N2)	N/A (N2)	N/A (N2)	N/A (N2)	33375.00	34178.33
4500 HD 2.3CDTi BiTurbo (163PS) S/S Tacho BlueInjection	2375	2110	N/A (N2)	N/A (N2)	N/A (N2)	N/A (N2)	35735.00	36538.33
L3 H3 RWD PANEL VAN (EURO VIc)								
3500 2.3CDTi BiTurbo (130PS) BlueInjection	2356	1129	30.4 (9.3)	32.5 (8.7)	31.4 (9.0)	232	32000.00	32888.33
3500 2.3CDTi BiTurbo (145PS) S/S BlueInjection	2356	1129	34.4 (8.2)	34.9 (8.1)	34.4 (8.2)	212	33110.00	33998.33
3500 HD 2.3CDTi BiTurbo (130PS) BlueInjection	2408	1077	29.4 (9.6)	30.7 (9.2)	30.4 (9.3)	242	32600.00	33488.33
3500 HD 2.3CDTi BiTurbo (145PS) S/S BlueInjection	2408	1077	33.2 (8.5)	32.8 (8.6)	32.8 (8.6)	222	33710.00	34598.33
4500 HD 2.3CDTi BiTurbo (130PS) Tacho BlueInjection	2408	2077	N/A (N2)	N/A (N2)	N/A (N2)	N/A (N2)	34075.00	34878.33
4500 HD 2.3CDTi BiTurbo (163PS) S/S Tacho BlueInjection	2408	2077	N/A (N2)	N/A (N2)	N/A (N2)	N/A (N2)	36435.00	37238.33

Please note: On-the-road recommended retail prices (RRP) include number plates and delivery to Retailer of £583.33 (exc. VAT), 12 months' Vehicle Excise Duty at £250.00 (£165.00 on 4500kg models) and new vehicle first registration fee of £55.00. Excludes fuel and insurance. S/S = Start/Stop.

Vehicles with BlueInjection technology will need regular AdBlue® top-ups also between servicing requirements. An indicator integrated into the on-board computer will warn you when you need to top up. More information under www.vauxhall.co.uk/blueinjection. In accordance with regulations R (EC) No. 715/2007 and R (EC) No. 692/2008 (in the versions respectively applicable).

* = For definitions please refer to Glossary of Terms.

= Fuel consumption information is official government environmental data, tested in accordance with the relevant EU directive. Official EU-regulated test data is provided for comparison purposes and actual performance will depend on driving style, road conditions and other non-technical factors.

MOVANO PANEL VAN PRICES

BEST HEAVY VAN
Vauxhall Movano 3500
L2H2 FWD Eu6
BiTurbo 145ps Eu6



Model	Minimum Mass (kg)*	Payload (kg)*	Fuel economy mpg (litres/100km)#			CO ₂ emissions (g/km)#	Price (£) exc. VAT	On-the-road RRP (£) exc. VAT
			Urban driving	Extra-urban driving	Combined figure			
L4 H2 RWD PANEL VAN (EURO VIc)								
3500 2.3CDTi BiTurbo (130PS) BlueInjection	2398	1087	30.4 (9.3)	32.5 (8.7)	31.4 (9.0)	232	32200.00	33088.33
3500 2.3CDTi BiTurbo (145PS) S/S BlueInjection	2398	1087	34.4 (8.2)	34.9 (8.1)	34.4 (8.2)	212	33310.00	34198.33
3500 2.3CDTi BiTurbo (163PS) S/S BlueInjection	2398	1087	34.4 (8.2)	34.9 (8.1)	34.4 (8.2)	212	34560.00	35448.33
3500 HD 2.3CDTi BiTurbo (130PS) BlueInjection	2453	1032	29.4 (9.6)	30.7 (9.2)	30.4 (9.3)	242	32800.00	33688.33
3500 HD 2.3CDTi BiTurbo (145PS) S/S BlueInjection	2453	1032	33.2 (8.5)	32.8 (8.6)	32.8 (8.6)	222	33910.00	34798.33
4500 HD 2.3CDTi BiTurbo (130PS) Tacho BlueInjection	2453	2032	N/A (N2)	N/A (N2)	N/A (N2)	N/A (N2)	34275.00	35078.33
4500 HD 2.3CDTi BiTurbo (163PS) S/S Tacho BlueInjection	2453	2032	N/A (N2)	N/A (N2)	N/A (N2)	N/A (N2)	36635.00	37438.33
L4 H3 RWD PANEL VAN (EURO VIc)								
3500 2.3CDTi BiTurbo (130PS) BlueInjection	2429	1056	30.4 (9.3)	32.5 (8.7)	31.4 (9.0)	232	32900.00	33788.33
3500 2.3CDTi BiTurbo (145PS) S/S BlueInjection	2429	1056	34.4 (8.2)	34.9 (8.1)	34.4 (8.2)	212	34010.00	34898.33
3500 2.3CDTi BiTurbo (163PS) S/S BlueInjection	2429	1056	34.4 (8.2)	34.9 (8.1)	34.4 (8.2)	212	35260.00	36148.33
3500 HD 2.3CDTi BiTurbo (130PS) BlueInjection	2495	990	29.4 (9.6)	30.7 (9.2)	30.4 (9.3)	242	33500.00	34388.33
3500 HD 2.3CDTi BiTurbo (145PS) S/S BlueInjection	2495	990	33.2 (8.5)	32.8 (8.6)	32.8 (8.6)	222	34610.00	35498.33
4500 HD 2.3CDTi BiTurbo (130PS) Tacho BlueInjection	2495	1990	N/A (N2)	N/A (N2)	N/A (N2)	N/A (N2)	34975.00	35778.33
4500 HD 2.3CDTi BiTurbo (163PS) S/S Tacho BlueInjection	2495	1990	N/A (N2)	N/A (N2)	N/A (N2)	N/A (N2)	37335.00	38138.33

Please note: On-the-road recommended retail prices (RRP) include number plates and delivery to Retailer of £583.33 (exc. VAT), 12 months' Vehicle Excise Duty at £250.00 (£165.00 on 4500kg models) and new vehicle first registration fee of £55.00. Excludes fuel and insurance.

S/S = Start/Stop.

Vehicles with BlueInjection technology will need regular AdBlue® top-ups also between servicing requirements. An indicator integrated into the on-board computer will warn you when you need to top up. More information under www.vauxhall.co.uk/blueinjection. In accordance with regulations R (EC) No. 715/2007 and R (EC) No. 692/2008 (in the versions respectively applicable).

* = For definitions please refer to Glossary of Terms.

= Fuel consumption information is official government environmental data, tested in accordance with the relevant EU directive. Official EU-regulated test data is provided for comparison purposes and actual performance will depend on driving style, road conditions and other non-technical factors.

MOVANO DOUBLECAB PRICES

Model	Minimum Mass (kg)*	Payload (kg)*	Fuel economy mpg (litres/100km)#			CO ₂ emissions (g/km)#	Price (£) exc. VAT	On-the-road RRP (£) exc. VAT
			Urban driving	Extra-urban driving	Combined figure			
L2 H2 FWD DOUBLECAB (EURO 6)								
3500 2.3CDTi (130PS) BlueInjection	2205	1305	31.4 (9.0)	39.2 (7.2)	35.8 (7.9)	207	30950.00	31838.33
3500 2.3CDTi BiTurbo (145PS) S/S BlueInjection	2205	1305	36.2 (7.8)	41.5 (6.8)	39.2 (7.2)	186	32060.00	32948.33
3500 2.3CDTi BiTurbo (170PS) S/S Tecshift BlueInjection	2205	1305	36.7 (7.7)	40.4 (7.0)	38.7 (7.3)	189	34185.00	35073.33
L3 H2 FWD DOUBLECAB (EURO 6)								
3500 2.3CDTi (130PS) BlueInjection	2286	1224	31.4 (9.0)	39.2 (7.2)	35.8 (7.9)	207	31650.00	32538.33
3500 2.3CDTi BiTurbo (145PS) S/S BlueInjection	2286	1224	36.2 (7.8)	41.5 (6.8)	39.2 (7.2)	186	32760.00	33648.33
3500 2.3CDTi BiTurbo (170PS) S/S Tecshift BlueInjection	2286	1224	36.7 (7.7)	40.4 (7.0)	38.7 (7.3)	189	34885.00	35773.33
L3 H2 RWD DOUBLECAB (EURO VIc)								
3500 2.3CDTi BiTurbo (130PS) BlueInjection	2553	957	30.4 (9.3)	32.5 (8.7)	31.4 (9.0)	232	32950.00	33838.33
3500 2.3CDTi BiTurbo (145PS) S/S BlueInjection	2553	957	34.4 (8.2)	34.9 (8.1)	34.4 (8.2)	212	34060.00	34948.33

Please note: On-the-road recommended retail prices (RRP) include number plates and delivery to Retailer of £583.33 (exc. VAT), 12 months' Vehicle Excise Duty at £250.00 and new vehicle first registration fee of £55.00. Excludes fuel and insurance.

S/S = Start/Stop.

Vehicles with BlueInjection technology will need regular AdBlue® top-ups also between servicing requirements. An indicator integrated into the on-board computer will warn you when you need to top up. More information under www.vauxhall.co.uk/blueinjection. In accordance with regulations R (EC) No. 715/2007 and R (EC) No. 692/2008 (in the versions respectively applicable).

* = For definitions please refer to Glossary of Terms.

= Fuel consumption information is official government environmental data, tested in accordance with the relevant EU directive. Official EU-regulated test data is provided for comparison purposes and actual performance will depend on driving style, road conditions and other non-technical factors.

MOVANO CHASSIS CAB PRICES

Model	Minimum Mass (kg)*	Payload and Body Allowance (kg)*	Fuel economy mpg (litres/100km)#			CO ₂ emissions (g/km)#	Price (£) exc. VAT	On-the-road RRP (£) exc. VAT
			Urban driving	Extra-urban driving	Combined figure			
L2 H1 FWD CHASSIS CAB (EURO 6)								
3500 2.3CDTi (110PS) BlueInjection	1784	1756	30.4 (9.3)	37.7 (7.5)	34.4 (8.2)	212	26800.00	27688.33
3500 2.3CDTi (130PS) BlueInjection	1784	1756	30.4 (9.3)	37.7 (7.5)	34.4 (8.2)	212	27600.00	28488.33
L3 H1 FWD CHASSIS CAB (EURO 6)								
3500 2.3CDTi (110PS) BlueInjection	1810	1730	30.4 (9.3)	37.7 (7.5)	34.4 (8.2)	212	27300.00	28188.33
3500 2.3CDTi (130PS) BlueInjection	1810	1730	30.4 (9.3)	37.7 (7.5)	34.4 (8.2)	212	28100.00	28988.33
3500 2.3CDTi BiTurbo (145PS) S/S BlueInjection	1819	1721	35.8 (7.9)	39.8 (7.1)	38.2 (7.4)	192	29210.00	30098.33
L2 H1 RWD CHASSIS CAB (EURO VIc)								
3500 2.3CDTi BiTurbo (130PS) BlueInjection	1928	1612	30.4 (9.3)	32.5 (8.7)	31.4 (9.0)	232	28900.00	29788.33
3500 HD 2.3CDTi BiTurbo (130PS) BlueInjection	2095	1445	29.4 (9.6)	30.7 (9.2)	30.4 (9.3)	242	29515.00	30403.33
4500 HD 2.3CDTi BiTurbo (163PS) S/S Tacho BlueInjection	2095	2445	N/A (N2)	N/A (N2)	N/A (N2)	N/A (N2)	33350.00	34153.33
L3 H1 RWD CHASSIS CAB (EURO VIc)								
3500 2.3CDTi BiTurbo (130PS) BlueInjection	1979	1561	30.4 (9.3)	32.5 (8.7)	31.4 (9.0)	232	29400.00	30288.33
3500 2.3CDTi BiTurbo (145PS) S/S BlueInjection	1979	1561	34.4 (8.2)	34.9 (8.1)	34.4 (8.2)	212	30510.00	31398.33
3500 HD 2.3CDTi BiTurbo (130PS) BlueInjection	2103	1437	29.4 (9.6)	30.7 (9.2)	30.4 (9.3)	242	30000.00	30888.33
3500 HD 2.3CDTi BiTurbo (145PS) S/S BlueInjection	2103	1437	33.2 (8.5)	32.8 (8.6)	32.8 (8.6)	222	31110.00	31998.33
4500 HD 2.3CDTi BiTurbo (163PS) S/S Tacho BlueInjection	2095	2445	N/A (N2)	N/A (N2)	N/A (N2)	N/A (N2)	33835.00	34638.33
L4 H1 RWD CHASSIS CAB (EURO VIc)								
3500 HD 2.3CDTi BiTurbo (130PS) BlueInjection	2133	1407	29.4 (9.6)	30.7 (9.2)	30.4 (9.3)	242	30700.00	31588.33
3500 HD 2.3CDTi BiTurbo (145PS) S/S BlueInjection	2133	1407	33.2 (8.5)	32.8 (8.6)	32.8 (8.6)	222	31810.00	32698.33
4500 HD 2.3CDTi BiTurbo (163PS) S/S Tacho BlueInjection	2133	2407	N/A (N2)	N/A (N2)	N/A (N2)	N/A (N2)	34535.00	35338.33

Please note: On-the-road recommended retail prices (RRP) include number plates and delivery to Retailer of £583.33 (exc. VAT), 12 months' Vehicle Excise Duty at £250.00 (£165.00 on 4500kg models) and new vehicle first registration fee of £55.00. Excludes fuel and insurance.

S/S = Start/Stop.

Vehicles with BlueInjection technology will need regular AdBlue® top-ups also between servicing requirements. An indicator integrated into the on-board computer will warn you when you need to top up. More information under www.vauxhall.co.uk/blueinjection. In accordance with regulations R (EC) No. 715/2007 and R (EC) No. 692/2008 (in the versions respectively applicable).

All conversions must follow 'Vauxhall Converter Requirements' including recommended dimensional data, detailed within Part 1, available at: www.vauxhall.co.uk/conversiondata. The weight of any fitted conversion body will have to be deducted from these figures to establish actual payload and is subject to correct weight distribution. Variations from the recommended dimensions or weights may affect the vehicle's overall centre of gravity and stability. From 29 April 2013 conversion of N1 vehicles was affected by changes to type approval – for further information refer to the VCA website (N2 vehicles were affected from 29 October 2014). For further information please contact conversions@vauxhall.co.uk

* = For definitions please refer to Glossary of Terms.

= Fuel consumption information is official government environmental data, tested in accordance with the relevant EU directive. Official EU-regulated test data is provided for comparison purposes and actual performance will depend on driving style, road conditions and other non-technical factors.

All conversions must follow 'Conversion Requirements' available on: www.vauxhall.co.uk/conversiondata

MOVANO CREW CAB PRICES

Model	Minimum Mass (kg)*	Payload and Body Allowance (kg)*	Fuel economy mpg (litres/100km)#			CO ₂ emissions (g/km)#	Price (£) exc. VAT	On-the-road RRP (£) exc. VAT
			Urban driving	Extra-urban driving	Combined figure			
L2 H1 FWD CREW CAB (EURO 6)								
3500 2.3CDTi (130PS) BlueInjection	1990	1550	30.4 (9.3)	37.7 (7.5)	34.4 (8.2)	212	28500.00	29388.33
L3 H1 FWD CREW CAB (EURO 6)								
3500 2.3CDTi (130PS) BlueInjection	2034	1506	30.4 (9.3)	37.7 (7.5)	34.4 (8.2)	212	29000.00	29888.33
L2 H1 RWD CREW CAB (EURO Vic)								
3500 2.3CDTi BiTurbo (130PS) BlueInjection	2164	1376	30.4 (9.3)	32.5 (8.7)	31.4 (9.0)	232	29800.00	30688.33
L3 H1 RWD CREW CAB (EURO Vic)								
3500 2.3CDTi BiTurbo (130PS) BlueInjection	2197	1343	30.4 (9.3)	32.5 (8.7)	31.4 (9.0)	232	30300.00	31188.33
3500 HD 2.3CDTi BiTurbo (130PS) BlueInjection	2283	1257	29.4 (9.6)	30.7 (9.2)	30.4 (9.3)	242	30900.00	31788.33
4500 HD 2.3CDTi BiTurbo (130PS) Tacho BlueInjection	2283	2257	N/A (N2)	N/A (N2)	N/A (N2)	N/A (N2)	32375.00	33178.33
4500 HD 2.3CDTi BiTurbo (163PS) S/S Tacho BlueInjection	2283	2257	N/A (N2)	N/A (N2)	N/A (N2)	N/A (N2)	34735.00	35538.33
L4 H1 RWD CREW CAB (EURO Vic)								
3500 HD 2.3CDTi BiTurbo (130PS) BlueInjection	2352	1188	29.4 (9.6)	30.7 (9.2)	30.4 (9.3)	242	31600.00	32488.33
4500 HD 2.3CDTi BiTurbo (163PS) S/S Tacho BlueInjection	2352	2188	N/A (N2)	N/A (N2)	N/A (N2)	N/A (N2)	35435.00	36238.33

Please note: On-the-road recommended retail prices (RRP) include number plates and delivery to Retailer of £583.33 (exc. VAT), 12 months' Vehicle Excise Duty at £250.00 (£165.00 on 4500kg models) and new vehicle first registration fee of £55.00. Excludes fuel and insurance.

S/S = Start/Stop.

Vehicles with BlueInjection technology will need regular AdBlue® top-ups also between servicing requirements. An indicator integrated into the on-board computer will warn you when you need to top up. More information under www.vauxhall.co.uk/blueinjection. In accordance with regulations R (EC) No. 715/2007 and R (EC) No. 692/2008 (in the versions respectively applicable).

All conversions must follow 'Vauxhall Converter Requirements' including recommended dimensional data, detailed within Part 1, available at: www.vauxhall.co.uk/conversiondata. The weight of any fitted conversion body will have to be deducted from these figures to establish actual payload and is subject to correct weight distribution. Variations from the recommended dimensions or weights may affect the vehicle's overall centre of gravity and stability. From 29 April 2013 conversion of N1 vehicles was affected by changes to type approval – for further information refer to the VCA website (N2 vehicles were affected from 29 October 2014). For further information please contact conversions@vauxhall.co.uk

* = For definitions please refer to Glossary of Terms.

= Fuel consumption information is official government environmental data, tested in accordance with the relevant EU directive. Official EU-regulated test data is provided for comparison purposes and actual performance will depend on driving style, road conditions and other non-technical factors.

All conversions must follow 'Conversion Requirements' available on: www.vauxhall.co.uk/conversiondata

MOVANO PLATFORM CAB PRICES

Model	Minimum Mass (kg)*	Payload and Body Allowance (kg)*	Fuel economy mpg (litres/100km)#			CO ₂ emissions (g/km)#	Price (£) exc. VAT	On-the-road RRP (£) exc. VAT
			Urban driving	Extra-urban driving	Combined figure			
L2 H1 FWD PLATFORM CAB (EURO 6)								
3500 2.3CDTi (130PS) BlueInjection	1697	1843	31.4 (9.0)	39.2 (7.2)	35.8 (7.9)	207	27600.00	28488.33
L2 H2 FWD PLATFORM CAB (EURO 6)								
3500 2.3CDTi (130PS) BlueInjection	1711	1829	31.4 (9.0)	39.2 (7.2)	35.8 (7.9)	207	28200.00	29088.33
L3 H1 FWD PLATFORM CAB (EURO 6)								
3500 2.3CDTi (130PS) BlueInjection	1719	1821	31.4 (9.0)	39.2 (7.2)	35.8 (7.9)	207	28100.00	28988.33
3500 2.3CDTi BiTurbo (145PS) S/S BlueInjection	1728	1812	35.8 (7.9)	39.8 (7.1)	38.2 (7.4)	192	29210.00	30098.33
L3 H2 FWD PLATFORM CAB (EURO 6)								
3500 2.3CDTi (130PS) BlueInjection	1735	1805	30.4 (9.3)	37.7 (7.5)	34.4 (8.2)	212	28700.00	29588.33
3500 2.3CDTi BiTurbo (145PS) S/S BlueInjection	1744	1796	35.8 (7.9)	39.8 (7.1)	38.2 (7.4)	192	29810.00	30698.33

Please note: On-the-road recommended retail prices (RRP) include number plates and delivery to Retailer of £583.33 (exc. VAT), 12 months' Vehicle Excise Duty at £250.00 and new vehicle first registration fee of £55.00. Excludes fuel and insurance. S/S = Start/Stop.

Vehicles with BlueInjection technology will need regular AdBlue® top-ups also between servicing requirements. An indicator integrated into the on-board computer will warn you when you need to top up. More information under www.vauxhall.co.uk/blueinjection. In accordance with regulations R (EC) No. 715/2007 and R (EC) No. 692/2008 (in the versions respectively applicable).

All conversions must follow 'Vauxhall Converter Requirements' including recommended dimensional data, detailed within Part 1, available at: www.vauxhall.co.uk/conversiondata. The weight of any fitted conversion body will have to be deducted from these figures to establish actual payload and is subject to correct weight distribution. Variations from the recommended dimensions or weights may affect the vehicle's overall centre of gravity and stability. From 29 April 2013 conversion of N1 vehicles was affected by changes to type approval – for further information refer to the VCA website (N2 vehicles were affected from 29 October 2014). For further information please contact conversions@vauxhall.co.uk

* = For definitions please refer to Glossary of Terms.

= Fuel consumption information is official government environmental data, tested in accordance with the relevant EU directive. Official EU-regulated test data is provided for comparison purposes and actual performance will depend on driving style, road conditions and other non-technical factors.

All conversions must follow 'Conversion Requirements' available on: www.vauxhall.co.uk/conversiondata

MOVANO TIPPER PRICES

Model	Minimum Mass (kg)*	Payload (kg)*	Fuel economy mpg (litres/100km)#			CO ₂ emissions (g/km)#	Price (£) exc. VAT	On-the-road RRP (£) exc. VAT
			Urban driving	Extra-urban driving	Combined figure			
L2 H1 FWD CHASSIS CAB TIPPER (EURO 6)								
3500 2.3CDTi (130PS) BlueInjection	2381	1159	31.4 (9.0)	39.2 (7.2)	35.8 (7.9)	207	31350.00	32238.33
3500 2.3CDTi BiTurbo (145PS) S/S BlueInjection	2391	1149	36.2 (7.8)	40.4 (7.0)	38.7 (7.3)	189	32460.00	33348.33
3500 2.3CDTi BiTurbo (170PS) S/S BlueInjection	2391	1149	35.8 (7.9)	39.8 (7.1)	38.2 (7.4)	192	33710.00	34598.33
L2 H1 RWD CHASSIS CAB TIPPER (EURO V1c)								
3500 HD 2.3CDTi BiTurbo (130PS) BlueInjection	2661	879	29.4 (9.6)	30.7 (9.2)	30.4 (9.3)	242	33250.00	34138.33
3500 HD 2.3CDTi BiTurbo (145PS) S/S BlueInjection	2661	879	33.2 (8.5)	32.8 (8.6)	32.8 (8.6)	222	34360.00	35248.33
3500 HD 2.3CDTi BiTurbo (163PS) S/S BlueInjection	2661	879	33.2 (8.5)	32.8 (8.6)	32.8 (8.6)	222	35610.00	36498.33
4500 HD 2.3CDTi BiTurbo (163PS) S/S Tacho BlueInjection	2661	1879	N/A (N2)	N/A (N2)	N/A (N2)	N/A (N2)	37085.00	37888.33
L3 H1 RWD CHASSIS CAB TIPPER (EURO V1c)								
3500 HD 2.3CDTi BiTurbo (130PS) BlueInjection	2773	767	29.4 (9.6)	30.7 (9.2)	30.4 (9.3)	242	34950.00	35838.33
3500 HD 2.3CDTi BiTurbo (145PS) S/S BlueInjection	2773	767	33.2 (8.5)	32.8 (8.6)	32.8 (8.6)	222	36060.00	36948.33
4500 HD 2.3CDTi BiTurbo (163PS) S/S Tacho BlueInjection	2773	1617	N/A (N2)	N/A (N2)	N/A (N2)	N/A (N2)	38785.00	39588.33
L3 H1 FWD CREW CAB TIPPER (EURO 6)								
3500 2.3CDTi (130PS) BlueInjection	2511	1029	30.7 (9.2)	38.2 (7.4)	34.9 (8.1)	210	32750.00	33638.33
3500 2.3CDTi BiTurbo (145PS) S/S BlueInjection	2520	1020	36.2 (7.8)	40.4 (7.0)	38.7 (7.3)	189	33860.00	34748.33
L3 H1 RWD CREW CAB TIPPER (EURO V1c)								
4500 HD 2.3CDTi BiTurbo (163PS) S/S Tacho BlueInjection	2830	1710	N/A (N2)	N/A (N2)	N/A (N2)	N/A (N2)	38485.00	39288.33

Please note: On-the-road recommended retail prices (RRP) include number plates and delivery to Retailer of £583.33 (exc. VAT), 12 months' Vehicle Excise Duty at £250.00 (£165.00 on 4500kg models) and new vehicle first registration fee of £55.00. Excludes fuel and insurance.

S/S = Start/Stop.

Vehicles with BlueInjection technology will need regular AdBlue® top-ups also between servicing requirements. An indicator integrated into the on-board computer will warn you when you need to top up. More information under www.vauxhall.co.uk/blueinjection. In accordance with regulations R (EC) No. 715/2007 and R (EC) No. 692/2008 (in the versions respectively applicable).

* = For definitions please refer to Glossary of Terms.

= Fuel consumption information is official government environmental data, tested in accordance with the relevant EU directive. Official EU-regulated test data is provided for comparison purposes and actual performance will depend on driving style, road conditions and other non-technical factors.

MOVANO DROPSIDE PRICES

Model	Minimum Mass (kg)*	Payload (kg)*	Fuel economy mpg (litres/100km)#			CO ₂ emissions (g/km)#	Price (£) exc. VAT	On-the-road RRP (£) exc. VAT
			Urban driving	Extra-urban driving	Combined figure			
L2 H1 FWD CHASSIS CAB DROPSIDE (EURO 6)								
3500 2.3CDTi (130PS) BlueInjection	2156	1384	31.7 (8.9)	39.8 (7.1)	36.2 (7.8)	204	29550.00	30438.33
3500 2.3CDTi BiTurbo (145PS) S/S BlueInjection	2166	1374	37.2 (7.6)	42.2 (6.7)	40.4 (7.0)	183	30660.00	31548.33
L3 H1 FWD CHASSIS CAB DROPSIDE (EURO 6)								
3500 2.3CDTi (130PS) BlueInjection	2228	1312	31.4 (9.0)	39.2 (7.2)	35.8 (7.9)	207	30550.00	31438.33
3500 2.3CDTi BiTurbo (145PS) S/S BlueInjection	2237	1303	36.2 (7.8)	41.5 (6.8)	39.2 (7.2)	186	31660.00	32548.33
L2 H1 RWD CHASSIS CAB DROPSIDE (EURO VIc)								
3500 2.3CDTi BiTurbo (130PS) BlueInjection	2356	1184	30.4 (9.3)	32.5 (8.7)	31.4 (9.0)	232	30850.00	31738.33
3500 2.3CDTi BiTurbo (145PS) S/S BlueInjection	2356	1184	34.4 (8.2)	34.9 (8.1)	34.4 (8.2)	212	31960.00	32848.33
3500 HD 2.3CDTi BiTurbo (130PS) BlueInjection	2447	1093	29.4 (9.6)	30.7 (9.2)	30.4 (9.3)	242	31465.00	32353.33
3500 HD 2.3CDTi BiTurbo (145PS) S/S BlueInjection	2447	1093	33.2 (8.5)	32.8 (8.6)	32.8 (8.6)	222	32575.00	33463.33
4500 HD 2.3CDTi BiTurbo (163PS) S/S Tacho BlueInjection	2447	2093	N/A (N2)	N/A (N2)	N/A (N2)	N/A (N2)	35300.00	36103.33
L3 H1 RWD CHASSIS CAB DROPSIDE (EURO VIc)								
3500 HD 2.3CDTi BiTurbo (145PS) S/S BlueInjection	2491	1049	33.2 (8.5)	32.8 (8.6)	32.8 (8.6)	222	33560.00	34448.33
4500 HD 2.3CDTi BiTurbo (130PS) Tacho BlueInjection	2496	2044	N/A (N2)	N/A (N2)	N/A (N2)	N/A (N2)	33925.00	34728.33
4500 HD 2.3CDTi BiTurbo (163PS) S/S Tacho BlueInjection	2496	2044	N/A (N2)	N/A (N2)	N/A (N2)	N/A (N2)	36285.00	37088.33
L4 H1 RWD CHASSIS CAB DROPSIDE (EURO VIc)								
3500 HD 2.3CDTi BiTurbo (145PS) S/S BlueInjection	2576	964	33.2 (8.5)	32.8 (8.6)	32.8 (8.6)	222	34260.00	35148.33
4500 HD 2.3CDTi BiTurbo (130PS) Tacho BlueInjection	2581	1959	N/A (N2)	N/A (N2)	N/A (N2)	N/A (N2)	34625.00	35428.33
4500 HD 2.3CDTi BiTurbo (163PS) S/S Tacho BlueInjection	2581	1959	N/A (N2)	N/A (N2)	N/A (N2)	N/A (N2)	36985.00	37788.33

Please note: On-the-road recommended retail prices (RRP) include number plates and delivery to Retailer of £583.33 (exc. VAT), 12 months' Vehicle Excise Duty at £250.00 (£165.00 on 4500kg models) and new vehicle first registration fee of £55.00. Excludes fuel and insurance.

S/S = Start/Stop.

Vehicles with BlueInjection technology will need regular AdBlue® top-ups also between servicing requirements. An indicator integrated into the on-board computer will warn you when you need to top up. More information under www.vauxhall.co.uk/blueinjection. In accordance with regulations R (EC) No. 715/2007 and R (EC) No. 692/2008 (in the versions respectively applicable).

* = For definitions please refer to Glossary of Terms.

= Fuel consumption information is official government environmental data, tested in accordance with the relevant EU directive. Official EU-regulated test data is provided for comparison purposes and actual performance will depend on driving style, road conditions and other non-technical factors.

MOVANO DROPSIDE PRICES

Model	Minimum Mass (kg)*	Payload (kg)*	Fuel economy mpg (litres/100km)#			CO ₂ emissions (g/km)#	Price (£) exc. VAT	On-the-road RRP (£) exc. VAT
			Urban driving	Extra-urban driving	Combined figure			
L2 H1 FWD CREW CAB DROPSIDE (EURO 6)								
3500 2.3CDTi (130PS) BlueInjection	2313	1227	31.4 (9.0)	39.2 (7.2)	35.8 (7.9)	207	30450.00	31338.33
L3 H1 FWD CREW CAB DROPSIDE (EURO 6)								
3500 2.3CDTi (130PS) BlueInjection	2384	1156	31.4 (9.0)	39.2 (7.2)	35.8 (7.9)	207	30950.00	31838.33
3500 2.3CDTi BiTurbo (145PS) S/S BlueInjection	2393	1147	36.2 (7.8)	41.5 (6.8)	39.2 (7.2)	186	32060.00	32948.33
3500 2.3CDTi BiTurbo (170PS) S/S BlueInjection	2393	1147	36.7 (7.7)	40.4 (7.0)	38.7 (7.3)	189	33310.00	34198.33
L2 H1 RWD CREW CAB DROPSIDE (EURO VIc)								
3500 2.3CDTi BiTurbo (130PS) BlueInjection	2471	1069	30.4 (9.3)	32.5 (8.7)	31.4 (9.0)	232	31750.00	32638.33
L3 H1 RWD CREW CAB DROPSIDE (EURO VIc)								
4500 HD 2.3CDTi BiTurbo (163PS) S/S Tacho BlueInjection	2642	1898	N/A (N2)	N/A (N2)	N/A (N2)	N/A (N2)	36685.00	37488.33
L4 H1 RWD CREW CAB DROPSIDE (EURO VIc)								
4500 HD 2.3CDTi BiTurbo (163PS) S/S Tacho BlueInjection	2626	1914	N/A (N2)	N/A (N2)	N/A (N2)	N/A (N2)	37885.00	38688.33

Please note: On-the-road recommended retail prices (RRP) include number plates and delivery to Retailer of £583.33 (exc. VAT), 12 months' Vehicle Excise Duty at £250.00 (£165.00 on 4500kg models) and new vehicle first registration fee of £55.00. Excludes fuel and insurance.

S/S = Start/Stop.

Vehicles with BlueInjection technology will need regular AdBlue® top-ups also between servicing requirements. An indicator integrated into the on-board computer will warn you when you need to top up. More information under www.vauxhall.co.uk/blueinjection. In accordance with regulations R (EC) No. 715/2007 and R (EC) No. 692/2008 (in the versions respectively applicable).

* = For definitions please refer to Glossary of Terms.

= Fuel consumption information is official government environmental data, tested in accordance with the relevant EU directive. Official EU-regulated test data is provided for comparison purposes and actual performance will depend on driving style, road conditions and other non-technical factors.

MOVANO BOX VAN PRICES

Model	Minimum Mass (kg)*	Payload (kg)*	Fuel economy mpg (litres/100km)#			CO ₂ emissions (g/km)#	Price (£) exc. VAT	On-the-road RRP (£) exc. VAT
			Urban driving	Extra-urban driving	Combined figure			
L3 H1 FWD CHASSIS CAB BOX VAN 20 cu.m (EURO 6)								
3500 2.3CDTi (130PS) BlueInjection	2400	1140	30.7 (9.2)	38.2 (7.4)	34.9 (8.1)	210	33780.00	34668.33
3500 2.3CDTi BiTurbo (170PS) S/S BlueInjection	2400	1140	35.8 (7.9)	39.8 (7.1)	38.2 (7.4)	192	36140.00	37028.33
L3 H1 RWD CHASSIS CAB BOX VAN 20 cu.m (EURO VIc)								
3500 2.3CDTi BiTurbo (130PS) BlueInjection	2560	980	30.4 (9.3)	32.5 (8.7)	31.4 (9.0)	232	36280.00	37168.33
3500 2.3CDTi BiTurbo (163PS) S/S BlueInjection	2560	980	34.4 (8.2)	34.9 (8.1)	34.4 (8.2)	212	38640.00	39528.33
L4 H1 RWD CHASSIS CAB BOX VAN 20 cu.m (EURO VIc)								
3500 HD 2.3CDTi BiTurbo (130PS) BlueInjection	2735	805	29.4 (9.6)	30.7 (9.2)	30.4 (9.3)	242	36530.00	37418.33
3500 HD 2.3CDTi BiTurbo (145PS) S/S BlueInjection	2735	805	33.2 (8.5)	32.8 (8.6)	32.8 (8.6)	222	37640.00	38528.33
4500 HD 2.3CDTi BiTurbo (163PS) S/S Tacho BlueInjection	2735	1805	N/A (N2)	N/A (N2)	N/A (N2)	N/A (N2)	40365.00	41168.33
L4 H1 RWD CHASSIS CAB BOX VAN 22 cu.m (EURO VIc)								
3500 HD 2.3CDTi BiTurbo (130PS) BlueInjection	2760	780	29.4 (9.6)	30.7 (9.2)	30.4 (9.3)	242	36730.00	37618.33
3500 HD 2.3CDTi BiTurbo (145PS) S/S BlueInjection	2760	780	33.2 (8.5)	32.8 (8.6)	32.8 (8.6)	222	37840.00	38728.33

Please note: On-the-road recommended retail prices (RRP) include number plates and delivery to Retailer of £583.33 (exc. VAT), 12 months' Vehicle Excise Duty at £250.00 (£165.00 on 4500kg models) and new vehicle first registration fee of £55.00. Excludes fuel and insurance.

S/S = Start/Stop.

Vehicles with BlueInjection technology will need regular AdBlue® top-ups also between servicing requirements. An indicator integrated into the on-board computer will warn you when you need to top up. More information under www.vauxhall.co.uk/blueinjection. In accordance with regulations R (EC) No. 715/2007 and R (EC) No. 692/2008 (in the versions respectively applicable).

* = For definitions please refer to Glossary of Terms.

= Fuel consumption information is official government environmental data, tested in accordance with the relevant EU directive. Official EU-regulated test data is provided for comparison purposes and actual performance will depend on driving style, road conditions and other non-technical factors.

MOVANO MINIBUS PRICES

Model	Minimum Mass (kg)*	Payload (kg)*	Fuel economy mpg (litres/100km)#			CO ₂ emissions (g/km)#	Price (£) exc. VAT	On-the-road RRP (£) inc. VAT
			Urban driving	Extra-urban driving	Combined figure			
L3 H2 FWD 17-SEAT MINIBUS (EURO VIc)								
3900 2.3CDTi BiTurbo (145PS) S/S Tacho BlueInjection	2660	1340	N/A (M2)	N/A (M2)	N/A (M2)	N/A (M2)	35399.17	43399.00

Please note: On-the-road recommended retail prices (RRP) include number plates and delivery to Retailer of £583.33 (exc. VAT), 12 months' Vehicle Excise Duty £165.00 and new vehicle first registration fee of £55.00. Excludes fuel and insurance. S/S = Start/Stop.

Vehicles with BlueInjection technology will need regular AdBlue® top-ups also between servicing requirements. An indicator integrated into the on-board computer will warn you when you need to top up. More information under www.vauxhall.co.uk/blueinjection. In accordance with regulations R (EC) No. 715/2007 and R (EC) No. 692/2008 (in the versions respectively applicable).

* = For definitions please refer to Glossary of Terms.

= Fuel consumption information is official government environmental data, tested in accordance with the relevant EU directive. Official EU-regulated test data is provided for comparison purposes and actual performance will depend on driving style, road conditions and other non-technical factors.

MOVANO TRABUS PRICES / FEATURES

Model	Minimum Mass (kg)*	Payload and Body Allowance (kg)*	Fuel economy mpg (litres/100km)#			CO ₂ emissions (g/km)#	Price (£) exc. VAT	On-the-road RRP (£) exc. VAT
			Urban driving	Extra-urban driving	Combined figure			
L2 H2 FWD TRABUS (EURO VIc)								
3900 2.3CDTi BiTurbo (145PS) S/S BlueInjection	2093	1837	N/A (M2)	N/A (M2)	N/A (M2)	N/A (M2)	31510.00	32313.33
L3 H2 FWD TRABUS (EURO VIc)								
3900 2.3CDTi BiTurbo (145PS) S/S BlueInjection	2171	1759	N/A (M2)	N/A (M2)	N/A (M2)	N/A (M2)	32060.00	32863.33

Please note: On-the-road recommended retail prices (RRP) include number plates and delivery to Retailer of £583.33 (exc. VAT), 12 months' Vehicle Excise Duty at £165.00 and new vehicle first registration fee of £55.00. Excludes fuel and insurance. S/S = Start/Stop.

Vehicles with BlueInjection technology will need regular AdBlue® top-ups also between servicing requirements. An indicator integrated into the on-board computer will warn you when you need to top up. More information under www.vauxhall.co.uk/blueinjection. In accordance with regulations R (EC) No. 715/2007 and R (EC) No. 692/2008 (in the versions respectively applicable).

All conversions must follow 'Vauxhall Convertor Requirements' including recommended dimensional data, detailed within Part 1, available at: www.vauxhall.co.uk/conversiondata. The weight of any fitted conversion body will have to be deducted from these figures to establish actual payload and is subject to correct weight distribution. Variations from the recommended dimensions or weights may affect the vehicle's overall centre of gravity and stability. From 29 April 2013 conversion of N1 vehicles was affected by changes to type approval – for further information refer to the VCA website (N2 vehicles were affected from 29 October 2014). For further information please contact conversions@vauxhall.co.uk

* = For definitions please refer to Glossary of Terms.

= Fuel consumption information is official government environmental data, tested in accordance with the relevant EU directive. Official EU-regulated test data is provided for comparison purposes and actual performance will depend on driving style, road conditions and other non-technical factors.

The Vauxhall Trabus is a fully glazed panel van without bulkhead suitable for conversion into a passenger vehicle by a third-party Convertor. The Trabus includes basic Type Approval for registration as a Category M* Passenger Vehicle and 2nd stage Type Approval must be completed by the Convertor to enable registration. Available in two wheelbases the Trabus is fitted with the highly efficient and economical 2.3CDTi BiTurbo Euro VI engine with Start/Stop. There are no interior seats or internal trim within the load compartment.

Movano Trabus feature highlights:

- Type-approved for Euro VI Category M emissions
- Driver's airbag
- Electronic stability programme
- Six-way adjustable driver's seat with armrest
- Dual front passengers' bench seat with dump latch facility
- Pulse cloth trim for front seats
- Digital Tachograph
- 62mph hardcoded Speed Limiter
- Front fog lights
- High beam assist
- Lane departure warning
- Multi-function trip computer
- Bulkhead not fitted
- Digital radio/CD/MP3 CD player/stereo radio/aux-in socket/Bluetooth® connectivity for compatible mobile phones/USB connectivity/integrated display/four 15-watt speakers (CD 16 DAB BT USB)
- No second or third-row seating
- Fixed windows – nearside and offside rear panels
- Selective door locking with three-button key
- Uprated battery (110Ah)
- Glazed rear doors (90°/180° opening)
- Under-floor full-size spare wheel
- Centre wheel covers (full-diameter wheel covers optional)
- Nearside sliding side-access door and opposite panel with fixed windows

* = M1 or M2 dependent on passenger configuration.

All conversions must follow 'Conversion Requirements' available on: www.vauxhall.co.uk/conversiondata

MOVANO CONVERSIONS2GO

Conversions2Go is a new addition to the Vauxhall conversion portfolio. These are carefully selected conversions from established Vauxhall approved converters chosen to complement the existing range of Factory Conversions. They can be ordered through Vauxhall and will be delivered to the Retailer as a complete converted vehicle. All conversions are fully type approved to ECWVTA (European Whole Vehicle Type Approval). Warranty and aftersales support of the conversion matches the base vehicle but is covered by the respective Converter.

Model	Minimum Mass (kg)*	Payload (kg)*	Fuel economy mpg (litres/100km)#			CO ₂ emissions (g/km)#	Price (£) exc. VAT	On-the-road RRP (£) exc. VAT
			Urban driving	Extra-urban driving	Combined figure			
L2 H1 RWD CHASSIS CAB ALUMINIUM TIPPER (EURO VIc)								
3500 2.3CDTi BiTurbo (130PS) BlueInjection	2308	1232	30.4 (9.3)	32.5 (8.7)	31.4 (9.0)	232	33795.00	34683.33
L3 H1 RWD CREW CAB ALUMINIUM TIPPER (EURO VIc)								
3500 2.3CDTi BiTurbo (130PS) BlueInjection	2577	963	30.4 (9.3)	32.5 (8.7)	31.4 (9.0)	232	35295.00	36183.33
L4 H1 RWD CREW CAB ALUMINIUM TIPPER (EURO VIc)								
3500 HD 2.3CDTi BiTurbo (130PS) BlueInjection	2684	856	29.4 (9.6)	30.7 (9.2)	30.4 (9.3)	242	36830.00	37718.33
L3 H1 FWD CHASSIS CAB LUTON BOX VAN WITH 500KG TAIL LIFT 17cu.m (EURO 6)								
3500 2.3CDTi (130PS) BlueInjection	2635	905	30.4 (9.3)	37.7 (7.5)	34.4 (8.2)	212	36395.00	37283.33
L3 H1 RWD CHASSIS CAB LUTON BOX VAN WITH 500KG TAIL LIFT 17cu.m (EURO VIc)								
3500 2.3CDTi BiTurbo (130PS) BlueInjection	2804	736	30.4 (9.3)	32.5 (8.7)	31.4 (9.0)	232	37695.00	38583.33
L3 H1 FWD PLATFORM CAB KNEE-HI LOW FLOOR LUTON BOX VAN 19cu.m (EURO 6)								
3500 2.3CDTi (130PS) BlueInjection	2229	1311	31.4 (9.0)	39.2 (7.2)	35.8 (7.9)	207	36510.00	37398.33

Please note: On-the-road recommended retail prices (RRP) include number plates and delivery to Retailer of £583.33 (exc. VAT), 12 months' Vehicle Excise Duty at £250.00 and new vehicle first registration fee of £55.00. Excludes fuel and insurance. Vehicles with BlueInjection technology will need regular AdBlue® top-ups also between servicing requirements. An indicator integrated into the on-board computer will warn you when you need to top up. More information under www.vauxhall.co.uk/blueinjection. In accordance with regulations R (EC) No. 715/2007 and R (EC) No. 692/2008 (in the versions respectively applicable).

* = For definitions please refer to Glossary of Terms.

= Fuel consumption information is official government environmental data, tested in accordance with the relevant EU directive. Official EU-regulated test data is provided for comparison purposes and actual performance will depend on driving style, road conditions and other non-technical factors. Please note, figures relate to the base chassis, crew and platform cabs prior to conversion.

Movano Aluminium Tipper L4 H1 RWD Crew Cab HD

IMPORTANT STATEMENT – To maintain N1 compliance for the above version careful note should be taken of factory ordered options which may impact the base vehicle weights and may affect N1 classification. Therefore if 6 passenger seats are required it is highly recommended that the vehicle is ordered without factory options that contribute to an increase in kerb weight. Alternatively, ordering a single passenger seat will have less impact and provide more scope for factory options.

The factory tow bar is not available for this version – if towing is required it is recommended that the converter towing option is ordered. The spare wheel, spare wheel carrier, tools and jack are removed (the spare wheel will be supplied loose).

MOVANO EQUIPMENT / OPTIONS

SAFETY

	Movano	Minibus	Trabus	Price (£) exc. VAT	Total (£) inc. VAT
Airbags:					
Driver's airbag	●	●	●		
Front passengers' airbag:					
• Front passengers' airbag with deactivation switch – Not available with Convenience Pack option.	○	○	○	260.00	312.00
					Option code: AK5
Stability:					
Electronic Stability Programme–plus (ESP–plus) with traction control – Works in conjunction with the vehicle's electronic braking and engine systems to keep the vehicle stable in many different situations. ESP monitors a variety of inputs to determine when the vehicle starts to lose traction, it can then immediately respond by varying the brake pressure between up to three wheels and adjust the engine output to help correct the loss of traction and improve stability.	●	●	●		
Braking:					
Four-channel Anti-lock Braking System (ABS) – Prevents the vehicle's wheels from locking up under heavy braking by momentarily reducing brake pressure at the appropriate wheel, ensuring that you can maintain control of the steering.	●	●	●		
Emergency brake assist – When emergency braking is detected the vehicle automatically applies the maximum possible braking assistance.	●	●	●		
Electronic brakeforce distribution – Automatically apportions the optimum braking force to each wheel.					
Hill start assist – Briefly maintains rear brake pressure to stop the vehicle rolling back on an incline.					
Advanced Safety Assist Pack:					
• Front fog lights • High beam headlight assist • Lane departure warning • Multi-function trip computer – Not available with Lighting Pack option. – Standard on Minibus / RWD HD 4500 models.	○	●	●	395.00	474.00
					Option code: XYCO
Bulkhead:					
• Full-height steel bulkhead without window – Standard on Panel Van / optional on Platform Cab models.	○			135.00	
					Option code: AX6
• Full-height ABS plastic bulkhead with window – Doublecab only.	●				
• Full-height steel bulkhead with window – Standard on Chassis / Crew Cab models. Optional on Panel Van / Platform Cab models.	○			50.00	
					Option code: AX9
M1 Type Approval:					
• M1 Type Approval for all rear seatbelt anchorages		●			

● = Standard equipment. ○ = Optional at extra cost.

MOVANO EQUIPMENT / OPTIONS

SECURITY

	Movano	Minibus	Trabus	Price (£) exc. VAT	Total (£) inc. VAT
Features:	●	●	●		
• Electronic engine deadlock immobiliser • Steering column lock • Secure fuel filler flap					
• Internal lockable rear and sliding side-access doors					
• Under-floor spare wheel storage – <i>Wind down only when rear doors opened.</i> – <i>Standard on Panel Van / Doublecab.</i>	●	●	●		
Remote control door locking (features depending on body type):	●	●	●		
• Selective door locking • Two keys with integral remote • Door deadlocks					
• Third key with integral remote	○	○	○	Option code: K69 60.00	72.00
Security alarm system:					
• Engine compartment protection • Ultrasonic detectors in load area • Siren • Thatcham Category 1 approved (TCL1–101/1103) – <i>Not available on Platform Cab models.</i>	○			Option code: UA6 305.00	

HEATING AND VENTILATION

Cab heating:	●	●	●		
• Four-speed fan • Illuminated controls • Four adjustable facia vents • Windscreen demist vents • Side window demist vents					
Air conditioning:					
• Air recirculation facility • Pollen filter • Illuminated controls • Chilled glovebox facility	○		○	Option code: C60 700.00	840.00
• Air conditioning front and rear		○	○	Option code: CJ5 2210.00	2652.00
• Additional rear compartment heating		○		Option code: C46 2010.00	2412.00
• Additional rear compartment air conditioning and heating		○	○	Option code: CAW 4210.00	5052.00
Electronic climate control:					
• Incorporating air conditioning • LCD temperature display • Automatic air direction and fan speed with manual override • Illuminated controls • Pollen filter • Chilled glovebox facility	○			Option code: C61 910.00	

● = Standard equipment. ○ = Optional at extra cost.

Please note: The air conditioning in vehicles with N1, N2 or M2 type approval relies upon fluorinated greenhouse gases (R134a) for its functioning. The front system contains a quantity of overall 580g of R 134a, which corresponds to a CO₂ equivalent of 0.83 tons. The front and rear system in versions with up to 9-seats contains a quantity of overall 1,100g of R 134a, which corresponds to a CO₂ equivalent of 1.57 tons. The front and rear system in versions with more than 16-seats contains a quantity of overall 1,700g of R 134a, which corresponds to a CO₂ equivalent of 2.43 tons. The global warming potential amounts to 1430. Information acc. to R (EU) No. 517/2014.

MOVANO EQUIPMENT / OPTIONS

COMFORT AND SEATING

	Movano	Minibus	Trabus	Price (£) exc. VAT	Total (£) inc. VAT
Comfort: • Height-adjustable steering wheel • Facia-mounted gear lever • Floor-mounted handbrake lever • Pulse cloth seat trim • Vinyl floor covering • Inertia-reel lap and diagonal seatbelts • Height-adjustable outer front seatbelts • Slip-resistant floor covering – <i>Minibus models.</i>	●	●	●		
Vinyl seat trim: • Grey vinyl seat trim – <i>Not available with Convenience Pack / Construction Pack / air-suspended driver's seat options / dual front passengers' multi-function office bench seat.</i> Option code: TACQ	○			50.00	
Driver's seat: • Height • Reach • Backrest recline • Height-adjustable padded head restraint • Driver's seat armrest	●	●	●		
'Comfort' driver's seat: • Lumbar adjustment • Height • Reach • Backrest recline • Height-adjustable padded head restraint • Centre fold-away armrest – <i>Not available with Construction Pack option. L4 R3500 HD Dropside models.</i> Option code: B21	○	○	○	135.00	162.00
Air-suspended driver's seat: • Lumbar adjustment • Height • Reach • Backrest recline • Height-adjustable padded head restraint • Centre fold-away armrest – <i>Not available with vinyl seat trim option.</i> – <i>Not available on L2 Doublecab / Tipper models.</i> Option code: A5Z	○		○	445.00	534.00
Dual front passengers' bench seat: • Fixed position bench seat and backrest • Centre seat features flat-folding backrest with twin drinks holders, flat work surface and storage tray • Height-adjustable outer front padded head restraint • Fixed centre seat padded head restraint	●		●		
Dual front passengers' multi-function office bench seat: • Dual front passengers' bench seat • Centre seat features flat-folding backrest with twin drinks holders, flat work surface and swivelling tray • Underseat storage Option code: ASY		●			
Single front passenger's seat: • Reach • Backrest recline • Height-adjustable padded head restraint – <i>Not available with Convenience Pack option.</i> Option code: AE1	○		○	60.00	
Single 'Comfort' front passenger's seat: • Lumbar adjustment • Reach • Backrest recline • Height-adjustable padded head restraint • Centre fold-away armrest – <i>Only available with driver's comfort / air-suspended driver's seat options.</i> Option code: AHZ	○		○	60.00	
Convenience Pack: • 'Comfort' driver's seat with armrest and lumbar support • Multi-function office bench seat with folding seat back on centre passenger seat including swivelling work tray and tilt forward seat cushions with underseat storage • Retractable A4 facia document clip • 'One-touch down' facility for driver's electrically operated window • Bulkhead soundproofing (excluding Platform Cab) – <i>Not available on Crew Cab models.</i> Option code: XiC6	○			235.00	
Full-length soft-trimmed headlining		●			
Full-height interior side mouldings		●			

● = Standard equipment. ○ = Optional at extra cost.

MOVANO EQUIPMENT / OPTIONS

REAR SEATING

	Movano	Minibus	Trabus	Price (£) exc. VAT	Total (£) inc. VAT
Doublecab seating: • Four-individually contoured rear seats • Inertia-reel lap and diagonal seatbelts • Padded head restraints • Integrated storage nets and cup holders • Full-length tray under rear seat cushion	●				
Minibus seating: • 14-individual rear passenger seats in staggered layout • Raised seating with illuminated gangway • Floor-mounted seat fixing rails and removable seats – <i>Last two rows of seats.</i>		●			
Option code: ATW		○		440.00	528.00

CABIN STORAGE

Accessory sockets: • 12-volt accessory socket beside gear lever	●	●	●
Facia storage: • Driver's coin, ticket and card holder • Driver's oddments storage • Lidded glovebox (11-litre capacity) • Central drinks holder • Front passenger semi-covered document tray	●	●	●
Front door pockets: • Large door pocket with capacity for a 2-litre drink bottle • Oddments pocket	●	●	●
Additional storage: • Overhead storage shelf	●	●	

● = Standard equipment. ○ = Optional at extra cost.

MOVANO EQUIPMENT / OPTIONS

DRIVER ASSISTANCE

	Movano	Minibus	Trabus	Price (£) exc. VAT	Total (£) inc. VAT
Windscreen wipers: • Two-speed windscreen wipers • Variable intermittent wipe • Electric screenwash	●	●	●		
Parking assistance: • Rear-view camera – Panel Van / Doublecab models. Option code: UVC	○			760.00	
• Rear parking distance sensors – Not available on Chassis / Crew / Platform Cab models or derivatives. Option code: UD7	○	○	○	275.00	330.00
• Rear-view camera • Rear parking distance sensors – Panel Van / Doublecab models. Option code: UCI	○			1025.00	1230.00
• Nearside blind-spot / junction mirror located in front passenger sunvisor	●	●	●		
Cruise control, speed limiter and multi-function trip computer: • Cruise control • Trip odometer • Vehicle range based on remaining fuel • Average speed • Average fuel economy • Instantaneous fuel economy • Driving time Option code: K34	○	○	○	260.00	312.00
Speed limiter – These are factory-fitted speed limiters that cannot be adjusted by driver: • Choice of three speeds: 56mph / 62mph / 68mph – 56mph speed limiter standard on RWD HD 4500 models. Option code: (56mph) KYJ – 62mph speed limiter standard on Minibus / Trabus. Option code: (62mph) KYK Option code: (68mph) KYL	○	●	●	85.00	102.00
Rear reversing lens Option code: D31		○		60.00	72.00

DRIVER INFORMATION

Instrumentation: • Speedometer • Rev counter • Digital fuel gauge with low fuel warning light • Coolant temperature gauge with warning light	●	●	●		
ECO features: • Shift-up indicator (manual models) – Indicates when to change gear for optimum fuel economy.	●	●	●		
Driver information display: • Monochrome display located in instrument cluster • Odometer • Service-due indicator • Displays trip computer data (when fitted)	●	●	●		
Central fascia display: • Audio information • Digital clock with automatic RDS time adjustment • Outside air temperature with ice warning function • Additional features and location dependent on infotainment unit (see Audio, Communication and Navigation for details)	●	●	●		
Warning indicators: • Low oil level, low brake fluid, brake pad wear, battery, fuel filter, low AdBlue® level, seatbelt warning and doors open	●	●	●		
Digital tachograph: • CANbus interface • Odometer display is changed from miles to kilometres – Standard on RWD HD 4500 / Minibus / Trabus models. – Not available with pneumatic rear suspension. – Important: The digital tachograph must be specified at time of ordering as it cannot be fitted retrospectively. Option price does not include calibration which must be carried out at an approved tachograph centre within 14 days of the vehicle's registration. Please note: The legislation regarding the use of tachographs is complex and operators should seek independent advice or speak to the Commercial Vehicle specialist at your Vauxhall retailer to ensure compliance. Alternatively your local DVLA office will also be able to provide clarification of the relevant legislation. Option code: TGP	○	●	●	535.00	642.00

● = Standard equipment. ○ = Optional at extra cost.

MOVANO EQUIPMENT / OPTIONS

INFOTAINMENT

	Movano	Minibus	Trabus	Price (£) exc. VAT	Total (£) inc. VAT
CD 16 BT USB: Onboard features: • DAB digital radio / AM/FM stereo radio with 18-station presets • CD/MP3 CD player • High-level display • RDS with Traffic Programme • Two 15-watt speakers Media connections: • USB connection with iPod control • Aux-in socket • Bluetooth® audio streaming (A2DP Profile) Mobile phone portal: • Bluetooth® connectivity • Handsfree calls via steering wheel controls • Vehicle microphone • Phone book access – <i>Contacts/last calls/missed calls etc. (features dependent on mobile phone).</i>	●	●	●		
NAVI 50 IntelliLink: Onboard features: • DAB digital radio / AM/FM stereo radio with 18-station presets • 7-inch facia-mounted colour touchscreen • RDS with Traffic Programme • Two 20-watt speakers Navigation features: • Satellite navigation system • 3D street level mapping • Major route mapping for Western Europe Media connections: • USB connection with iPod control • Aux-in socket • Bluetooth® audio streaming (A2DP Profile) Mobile phone portal: • Bluetooth® connectivity • Handsfree calls via steering wheel controls • Vehicle microphone • Phone book access – <i>Contacts/last calls/missed calls etc. are mirrored on IntelliLink's display and are easily navigated using the touchscreen (features dependent on mobile phone).</i> Option code: 100	○		○	660.00	792.00
NAVI 80 IntelliLink: Onboard features: • DAB digital radio / AM/FM stereo radio with 18-station presets • 7-inch facia-mounted colour touchscreen • RDS with Traffic Programme • Two speakers • 20 watts per channel output Navigation features: • Satellite navigation system • TomTom LIVE services (inclusive subscription for TomTom LIVE ends 31 December 2020, and cannot be renewed) • 3D street level mapping • Major route mapping for Western Europe Media connections: • USB connection with iPod control • Aux-in socket • Bluetooth® audio streaming (A2DP Profile) • Integrated voice control Mobile phone portal: • Bluetooth® connectivity • Handsfree calls via steering wheel controls • Vehicle microphone • Phone book access – <i>Contacts/last calls/missed calls etc. are mirrored on IntelliLink's display and are easily navigated using the touchscreen (features dependent on mobile phone).</i> Option code: 2L9	○		○	1080.00	1296.00
Additional features: • Steering column mounted audio controls • Flexible roof-mounted aerial	●	●	●		

● = Standard equipment. ○ = Optional at extra cost.

MOVANO EQUIPMENT / OPTIONS

LOAD ACCESS

	Movano	Minibus	Trabus	Price (£) exc. VAT	Total (£) inc. VAT
Nearside access:					
Nearside side-access door: • Nearside sliding side-access door • Unglazed – Standard on Panel Van.	●				
Nearside side-access door with fixed windows: • Fixed window to standard nearside sliding side-access door (£165) • Fixed window to opposite offside body panel (£165) – Standard on Doublecab.	▲	●	●	330.00	
Nearside side-access door with sliding windows: • Sliding window to standard nearside sliding side-access door (£335) • Sliding window to opposite offside body panel (£335)	▲		▲	670.00	
Nearside sidestep: • Electrically operated sidestep		●			
Offside access:					
Offside side-access door: • Offside sliding side-access door • Unglazed – Panel Van only.	▲			310.00	
Offside side-access door with fixed windows: • Fixed window to standard nearside sliding side-access door (£165) • Offside side-access door (£310) • Fixed window to offside side-access door (£165)	▲			640.00	
Offside side-access door with sliding windows: • Sliding window to standard nearside sliding side-access door (£335) • Offside side-access door (£310) • Sliding window to offside side-access door (£335)	▲			980.00	1176.00
Rear access:					
Rear solid doors: • Twin rear doors • 90°/180° opening • Twin rear doors • 270° opening – Not available on L1 models.	●				
	○			Option code: 7U4 285.00	
Rear glazed doors: • Glazed rear doors • 90°/180° opening • Glazed rear doors • 270° opening – Not available on L1 models.	○	●	●	Option code: J1X 110.00	
	○			Option code: J1T 385.00	
• Heated rear windows – Only available with glazed rear doors.	○	○	○	Option code: C49 110.00	132.00

● = Standard equipment. ○ = Optional at extra cost. ▲ = Please refer to ordering guide.

MOVANO EQUIPMENT / OPTIONS

GLAZED PACK

	Movano	Minibus	Trabus	Price (£) exc. VAT	Total (£) inc. VAT
<ul style="list-style-type: none"> Fixed window to standard nearside side-access door Fixed window to opposite offside body panel Rear glazed doors Rear glazed side panels 	○	●	●	430.00	
	Option code: A10				

LOAD RESTRAINT

Load anchorage: <ul style="list-style-type: none"> Fixed floor-mounted load restraint lashing eyes (L1 models x 6, L2/L3 models x 8, L4 models x 10) Nearside/offside rear door column load restraint lashing eyes Fixed side-mounted anchorage points (x 8) – <i>Not available with grab handle options.</i> 	●				
	Option code: ANY				
				85.00	
Load lining: <ul style="list-style-type: none"> Full-height plywood load lining Plywood wheel arch protection <i>– Not available with glazed side-access door(s) / Only available with resin-coated plywood load floor covering.</i> 	L1 ○			490.00	
	L2 ○			535.00	
	L3 ○			570.00	
	L4 ○			710.00	
	Option code: N20				
<ul style="list-style-type: none"> Resin-coated plywood load floor covering 	L1/L2 ○			330.00	
	L3/L4 ○			370.00	
	Option code: B68				

ADDITIONAL LOAD AREA FEATURES

Two grab handles (side-access and rear doors): <i>– Panel Van only. Not available with side-mounted anchorage points.</i>	○			75.00	
	Option code: XBBG				
Three grab handles (two side-access and rear doors): <i>– Panel Van only. Not available with side-mounted anchorage points.</i>	○			100.00	
	Option code: XBEJ				
Illuminated load area	●				
LED illuminated load area	○			95.00	
	Option code: XBHN				
Individual saloon lighting		●			

● = Standard equipment. ○ = Optional at extra cost.

MOVANO EQUIPMENT / OPTIONS

EXTERIOR CONVENIENCE / STYLING

	Movano	Minibus	Trabus	Price (£) exc. VAT	Total (£) inc. VAT
Exterior features:	●	●	●		
• Integral steps in front bumper • Laminated windscreen • Body side-protection mouldings					
• Front and rear mudflaps Option code: Q8H	○	○	○	80.00	96.00
• Rear bumper with integral step – Standard on RWD / RWD HD Panel Van / Doublecab models. Optional on FWD Panel Van / Doublecab models. Option code: VF6	○			260.00	312.00
Windows:	●	●	●		
• Electrically operated front windows					
• Top opening rear windows – L3 Trabus models only. Option code: AD5		○	○	1510.00	1812.00
Door mirrors:	●	●	●		
• Foldable electrically adjustable/heated door mirrors • Wide-angle mirror on driver's side • Integrated side-repeat indicators					
Extendable door mirrors (Chassis, Crew and Platform Cab):	○			85.00	
• Long arm exterior mirrors – Long arm exterior mirrors should be applied to any vehicle with an overall width of 2.17 to 2.35 metres. Option code: DBE					
Paint finish:	○	○	○		At extra cost
• Special paint – Restrictions apply, please consult your Retailer for details.					









EXTERIOR LIGHTING

Standard lighting:	●	●	●		
• Lights-on audible warning • Manual headlight beam levelling • Twin reversing lights • Hazard warning lights • Rear fog lights					
• Centre rear brake light (excluding Chassis / Crew / Platform Cab models or derivatives) • Side-repeater in exterior mirrors					
• Front fog lights – Standard on 4500 models. Option code: T3U	○	●	●	105.00	126.00
Lighting Pack:	○			255.00	306.00
• Static cornering lights • Front fog lights • Automatic lighting control • Rain-sensitive windscreen wipers • Door-to-door illumination – Standard on 4500 models. Option code: HME					

● = Standard equipment. ○ = Optional at extra cost.

MOVANO OPTIONS

EXTERIOR COLOURS

		Movano	Minibus	Trabus	Price (£) exc. VAT	Total (£) inc. VAT
	Polar White (GNY) • Solid paint					
	Signal Blue (GKX) • Solid paint	●	●	●		
	North Sea Blue (24U) • Solid paint					
	Saffron Yellow (98U) • Solid paint					
	Poppy Red (74U) • Brilliant paint	○	○	○	320.00	384.00
	Mandarin Orange (99U) • Brilliant paint					
	Halo Silver (GKY) • Two-coat metallic paint					
	Ambient Blue (GKW) • Two-coat metallic paint	○	○	○	450.00	540.00
	Pearl Black (GUK) • Two-coat metallic paint					

● = Standard equipment. ○ = Optional at extra cost.

The colours reproduced may vary slightly from the actual paint colour. As a result they should be used as a guide only. Your Vauxhall Retailer has a comprehensive display of our paint samples. On Cab and Conversion variants the colours illustrated apply to the vehicle cab only.





MOVANO EQUIPMENT / OPTIONS

WHEELS AND TYRES

	Movano	Minibus	Trabus	Price (£) exc. VAT	Total (£) inc. VAT
FWD 2800 / FWD 3300 models: • 6.5J x 16-inch steel wheels • 215/65 R 16 tyres • Full-size spare wheel • Wheel centre covers	●				
FWD 3500/3900 models: • 6.5J x 16-inch steel wheels • 225/65 R 16 tyres • Full-size spare wheel – <i>Excludes Minibus models.</i> • Wheel centre covers	●	●	●		
RWD 3500 models: • 7J x 16-inch steel wheels • 235/65 R 16 tyres • Full-size spare wheel • Wheel centre covers	●				
RWD HD 3500 / RWD HD 4500 models: • 5.5J x 16-inch steel wheels • 195/75 R 16 tyres • Twin rear wheels • Full-size spare wheel	●				
All-season tyres – Continental Vanco Four Season 2: FWD models: 225/65 R 16 – <i>Not available on FWD 2800 models.</i> RWD models: 235/65 R 16 RWD HD models: 195/75 R 16 Option code: NRK	○	○	○	360.00	432.00
Full-diameter wheel covers: – <i>Not available on RWD HD models.</i> Option code: QP9	○	○	○	60.00	72.00
Tyre inflation kit in lieu of spare wheel: – <i>Not available on RWD / RWD HD models.</i> Option code: WTC	N/C	●	N/C		No-cost option

● = Standard equipment. ○ = Optional at extra cost. N/C = No-cost option.

TYRE RATINGS

Tyre size	Fuel efficiency group	Wet grip performance	External noise	
			Measured (dB)	Group
195/75 R 16	B	B	72	
215/65 R 16	B	B	71	
225/65 R 16	B–E	B–C	70	
235/65 R 16	C–E	B	70	

Tyre rating according to EU Regulation 1222/2009

MOVANO EQUIPMENT / OPTIONS

MECHANICAL

	Movano	Minibus	Trabus	Price (£) exc. VAT	Total (£) inc. VAT																		
Transmission:																							
<ul style="list-style-type: none"> Six-speed manual gearbox: FWD models: • Transverse engine/gearbox • L1/L2/L3 models RWD / RWD HD models: • Longitudinal engine/gearbox • L3/L4 models Tecshift six-speed transmission: – Tecshift transmission adds electronic control for both the clutch and gear selection to the standard six speed transmission. Electronic clutch control: – Tecshift automatically operates the clutch, meaning that there is no clutch pedal and the vehicle can be driven by an 'automatic-only' driving licence holder. Electronic gear selection: – Tecshift also controls gear selection, leaving the driver with two gear-shifting options – automatic or manual. Automatic mode: – The driver selects forward or reverse gear and Tecshift does everything else, just like an automatic gearbox. Manual mode: – The driver can change gear sequentially by pushing the lever forward (higher gear) or pulling it backwards (lower gear). A 'kickdown' function: – going through two or more gears – is also possible in manual mode. 	●	●	●																				
	○				See price pages																		
Steering:																							
<ul style="list-style-type: none"> Power-assisted rack and pinion system • Turns lock-to-lock: 3.7 Turning circles: <table border="1"> <thead> <tr> <th></th> <th>Kerb-to-kerb</th> <th>Wall-to-wall</th> </tr> </thead> <tbody> <tr> <td>FWD L1</td> <td>12.0m (39.3ft.)</td> <td>12.5m (41.0ft.)</td> </tr> <tr> <td>FWD / RWD / RWD HD L2</td> <td>13.6m (44.6ft.)</td> <td>14.1m (46.2ft.)</td> </tr> <tr> <td>FWD L3</td> <td>15.7m (51.5ft.)</td> <td>16.2m (53.1ft.)</td> </tr> <tr> <td>RWD / RWD HD L3</td> <td>13.6m (44.6ft.)</td> <td>14.1m (46.2ft.)</td> </tr> <tr> <td>RWD / RWD HD L4</td> <td>15.7m (51.5ft.)</td> <td>16.2m (53.1ft.)</td> </tr> </tbody> </table>		Kerb-to-kerb	Wall-to-wall	FWD L1	12.0m (39.3ft.)	12.5m (41.0ft.)	FWD / RWD / RWD HD L2	13.6m (44.6ft.)	14.1m (46.2ft.)	FWD L3	15.7m (51.5ft.)	16.2m (53.1ft.)	RWD / RWD HD L3	13.6m (44.6ft.)	14.1m (46.2ft.)	RWD / RWD HD L4	15.7m (51.5ft.)	16.2m (53.1ft.)	●	●	●		
	Kerb-to-kerb	Wall-to-wall																					
FWD L1	12.0m (39.3ft.)	12.5m (41.0ft.)																					
FWD / RWD / RWD HD L2	13.6m (44.6ft.)	14.1m (46.2ft.)																					
FWD L3	15.7m (51.5ft.)	16.2m (53.1ft.)																					
RWD / RWD HD L3	13.6m (44.6ft.)	14.1m (46.2ft.)																					
RWD / RWD HD L4	15.7m (51.5ft.)	16.2m (53.1ft.)																					
Brakes:																							
<ul style="list-style-type: none"> Front ventilated disc brakes: • FWD / RWD / RWD HD: 302mm x 28mm Rear disc brakes: • FWD / RWD: 305mm x 12mm • RWD HD: 305mm x 18mm 	●	●	●																				
Power take-off (manual models only):																							
<ul style="list-style-type: none"> Engine driven power take-off – Single turbo FWD. Not with air conditioning / electronic climate control options. – BiTurbo FWD and all RWD. Only available with air conditioning / electronic climate control options. 	○			160.00																			
<ul style="list-style-type: none"> Gearbox-driven power take-off – RWD / RWD HD models only. – Not available with increased engine idle speed. 	○			460.00																			
<ul style="list-style-type: none"> Increased engine idle speed – Not available with 110PS Start/Stop engines. 	○			60.00																			
Fuel tank:																							
<ul style="list-style-type: none"> • 80 litres (17.6 gallons) capacity • 105 litres (23.1 gallons) capacity – Not available on Core Conversions (excluding L3 Box). 	●	●	●																				
	○		○	110.00	132.00																		
AdBlue® tank:																							
<ul style="list-style-type: none"> • 22 litres (4.8 gallons) capacity 	●	●	●																				

● = Standard equipment. ○ = Optional at extra cost.

MOVANO EQUIPMENT / OPTIONS

MECHANICAL

	Movano	Minibus	Trabus	Price (£) exc. VAT	Total (£) inc. VAT
Towing: <ul style="list-style-type: none"> • Tow bar with 13-pin electrics (does not suit trailers with LED lights) • Trailer stability programme – Unless specific exemptions apply, vehicles operated with a trailer, where the combined weight of the vehicle, trailer and payload exceeds 3500kg, require a digital tachograph. For trailers with LED lights use genuine Vauxhall Accessory tow bars which also include trailer stability programme. – Not available on Aluminium Tipper L4 H1 RWD Crew Cab HD models. 	○			385.00	462.00
Option code: VR2 / VTO					
Electrical: <ul style="list-style-type: none"> • 95Ah maintenance-free battery (105Ah on Tecshift models) • 185A alternator • Second battery – Not available with single passenger seat options / Air-suspended driver's seat. 	●	●	●		
Option code: 0BC	○	○		485.00	582.00
CANbus interface: Allows the vehicle's electrical systems to integrate with additional equipment. – Standard on RWD HD 4500 models.	○			135.00	
Option code: KC6					
Six-pin electrical connector for conversions: – Standard on Dropside / Tipper.	○			60.00	
Option code: KPD					
Vehicle tracking: A supplementary vehicle enhancement applied and supported by Masternaut as a 3rd Party Converter. This enhancement does not include Aftersales support. The enhancement is reversible. The telematics services are provided by Masternaut Limited ('Masternaut') and are subject to the end-user terms of Masternaut. Masternaut is an independent technology service provider. Vauxhall is not provider and not responsible for the telematics services offered by Masternaut.					
<ul style="list-style-type: none"> • Telematic box – Base 	○	○	○	250.00	300.00
Option code: XIDM					
<ul style="list-style-type: none"> • Telematic box – Premium 	○	○	○	320.00	384.00
Option code: XIDN					
Front suspension: <ul style="list-style-type: none"> • MacPherson type • Independent double wishbones • Coil springs • Telescopic dampers 	●	●	●		
Rear suspension: <ul style="list-style-type: none"> • Tubular axle • Telescopic dampers • Variable rate leaf springs FWD models: • Single leaf springs • Single rear wheels RWD models: • Double leaf springs • Single rear wheels RWD HD models: • Triple leaf springs • Twin rear wheels 	●	●	●		
Pneumatic rear suspension: – Only available with six-pin connector and CANbus. – Only available on FWD 3300 / FWD 3500 L2/L3 models.	○			2010.00	
Option code: F47					
Construction Pack (RWD models only): <ul style="list-style-type: none"> • Air-suspended driver's seat with armrest • Automatic locking rear differential • Tow bar with 13-pin electrics (does not suit trailers with LED lights) • Trailer stability programme – Not available on Tipper / Box Van. For trailers with LED lights use genuine Vauxhall Accessory tow bars which also include trailer stability programme. 	○			1035.00	
Option code: HMG					
Body Conversion Pack A (Chassis and Platform Cab): <ul style="list-style-type: none"> • Extended wiring loom • Six-pin connector for conversions • 16-pin connector for cab-based conversions 	○			95.00	
Option code: XZCM					
Body Conversion Pack B (Crew Cab): <ul style="list-style-type: none"> • Extended wiring loom • Six-pin connector for conversions 	○			60.00	
Option code: XZCN					
Automatic locking rear differential (RWD models only)	○			510.00	
Option code: G94					

● = Standard equipment. ○ = Optional at extra cost.

MOVANO EQUIPMENT / OPTIONS

ADDITIONAL FEATURES – TIPPER

		Price (£) exc. VAT	Total (£) inc. VAT
<p>Tipper assembly:</p> <ul style="list-style-type: none"> • Five-stage chrome-plated underfloor ram • Sliding and internal self-lubricating components made of reinforced nylon and Teflon • Anti-vibration Teflon plates on a secondary frame <p>Tipper deck:</p> <ul style="list-style-type: none"> • Steel platform, powder coated in dark grey • Integrated cabin protection, ladder rack and side under-run protection • 400mm anodised aluminium removable side and rear alloy panels with recessed hinges • Top and bottom hinged rear panel • Recessed side and tailboard operating levers • Removable rear posts • Galvanised fixing bolts • Automatically releasing rear panel during the rear tipping phase • Frame and cross-members in edged galvanised sheet <p>Electrics:</p> <ul style="list-style-type: none"> • Audible warning during operation • Fused power supply with isolator switch • Electro/hydraulic power pack • Side lights where required • Remote control on wander-lead located behind driver's seat <p>Exterior:</p> <ul style="list-style-type: none"> • Additional half-height tool box on L3 Chassis Cab Tipper models (2100 x 650 x 750mm) • Rear mudflaps <p>Load restraint:</p> <ul style="list-style-type: none"> • Eight integrated load lashing points conforming to DIN 75410 standards 	●		

ADDITIONAL FEATURES – DROPSIDE

<p>Exterior:</p> <ul style="list-style-type: none"> • Plywood load floor with non-slip resin surface coating • Integrated cabin protection, ladder rack and side under-run protection • 400mm anodised aluminium removable side and rear alloy panels with recessed hinges • Removable rear posts • Integrated load lashing rings conforming to DIN 75410 standards • Rear mudguards • Galvanised fixing bolts • Side lights where required • Frame and cross-members in edged galvanised sheet 	●		
---	---	--	--

ADDITIONAL FEATURES – BOX VAN

<p>Interior / exterior:</p> <ul style="list-style-type: none"> • Polyester lightweight box with smooth external appearance • Aluminium frame • Long arm exterior mirrors • Side under-run protection • 18mm plywood covered anti-slip floor • Twin rear 270° opening aluminium doors • Folding rear step fitted to offside 	●		
Luton head	○	Option code: Z1D	700.00
Rear roller shutter door	○	Option code: D5W	685.00

● = Standard equipment. ○ = Optional at extra cost.

RANGE GLOSSARY OF TERMS

PLATED WEIGHT

The maximum weight to which a vehicle or an axle may be loaded, determined either by the design of the components or by legislation. All commercial vehicles must carry a manufacturer's 'plate' showing the vehicle and axle gross 'plated weights'. It is an offence to drive a vehicle in a condition where any of these weights are exceeded.

MINIMUM MASS

Minimum Mass ('Mass in running order' on Certificate of Conformity and 'Mass in Service' on V5C form) is defined according to European Type Approval and include all fluids, tools, 90% fuel load and driver (75kg). It is minimum mass for this variant and does not consider local specification/trim or deletable options (specific to Movano). Weights are also subject to manufacturing tolerances (EU Legislation allows 5% tolerance).

GROSS VEHICLE WEIGHT (GVW)

The total permissible weight of a vehicle including payload and passengers, as shown on the manufacturer's plate.

GROSS COMBINATION WEIGHT (GCW)

The maximum permissible weight of a vehicle, including payload and passengers, combined with the total weight of any trailer it is towing. The maximum GCW weight limit is quoted on the vehicle plate and must not be exceeded.

PAYLOAD

The total permissible weight that can be carried without exceeding the vehicle's plated weight. Payload do not include driver but do take into consideration specification/trim level:

- For Combo included are UK specification (Panel Van 15kg; Crew Van 25kg) and also trim (Sportive L1 Panel Van 45kg; Sportive L2 Panel Van 30kg; Sportive Crew Van 20kg; Glazed Crew Van 40kg)
- For Vivaro included are UK specification (15kg) and trim (Sportive Panel Van 30kg; Sportive Doublecab 40kg; Limited Edition NAV Panel Van 45kg and Limited Edition NAV Doublecab 55kg)
- For Movano included are UK specification (10kg) and deletable options such as Bulkhead (25kg); Sliding Doors (30kg each) and Spare Wheel (25kg)

Weights are also subject to manufacturing tolerances (EU Legislation allows 5% tolerance). Payload does not consider any additional options that a customer may order.

ROOF LOADS

- Corsavan roof load should not exceed 75kg including the weight of the roof rack/carrier
- Combo roof load should not exceed 100kg on H1 models including the weight of the roof rack/carrier. H2 are not permitted to carry roof loads
- Vivaro roof load should not exceed 200kg (150kg on H2 models) including the weight of the roof rack/carrier
- Movano roof load should not exceed 200kg (150kg on H1 models) including the weight of the roof rack/carrier. H3 are not permitted to carry roof loads

MAXIMUM TOWING WEIGHT

The maximum weight of any trailer and its load which may be towed within the limit of the vehicle's plated Gross Combination Weight (GCW). It is based on the ability of the vehicle – at full GCW – to restart on a 12% gradient, which is approximately 1 in 8.3, at sea level. At altitudes above 1500 metres, the engine output may drop with a corresponding reduction in towing capability. It is the operator's responsibility to ensure that the trailer noseweight does not cause the rear axle plated weight of the towing vehicle to be exceeded.

Always fit Vauxhall towing attachments and accessories available from your Vauxhall Commercial Vehicle Retailer. They are designed specifically for Vauxhall models and carry a 12-month warranty.

LIGHT DUTY AND HEAVY DUTY CYCLES

For a Light Duty cycle (EC regulation 715/2007 with designation 'Euro 6') the emissions of the whole vehicle are evaluated whereas for Heavy Duty cycle (EC regulation 595/2009 with designation 'Euro VI') only the engine is bench tested. The requirement of which cycle is necessary is determined by the reference mass of the vehicle. In the case of Movano, reference mass calculations dictate that:

- N1 FWD and M1 FWD are approved as Light Duty
- N1 RWD, N2 RWD and M2 FWD are approved as Heavy Duty

When Euro 5 was previously introduced, there was an agreement between Member States and the Commission (Reference TEC 740/2011) that, assuming there was no alteration to the emissions system itself, a multi-stage build vehicle should be covered by the base vehicle emissions approval, irrespective of whether the reference mass had changed. The Department for Transport has confirmed that this interpretation will remain in place for Euro 6/VI.

To illustrate this better – a F3500 L3 H1 (130PS) Movano Chassis Cab is type approved as Light Duty (Euro 6). Regardless of any conversion to this vehicle and even if its reference mass transgresses above the 2840kg threshold, then it is still be covered by the original Light Duty cycle emissions. One situation where this may not apply is when a vehicle changes category from N1 (Commercial) to M1 (Passenger) during the process of conversion.

COMMERCIAL VEHICLE CATEGORIES

Differences between M1/N1 and M2/N2 (Vehicles with GVW above 3500kg)

Category M: Passenger carriers

Category M1: Vehicles designed and constructed for the carriage of passengers and comprising no more than eight seats in addition to the driver's seat.

Category M2: Vehicles designed and constructed for the carriage of passengers, comprising more than eight seats in addition to the driver's seat, and having a maximum mass not exceeding 5 tonnes.

Category N: Goods vehicles

Category N1: Vehicles designed and constructed for the carriage of goods and having a maximum mass not exceeding 3.5 tonnes.

Category N2: Vehicles designed and constructed for the carriage of goods and having a maximum mass exceeding 3.5 tonnes but not exceeding 12 tonnes.

Specific differences, all M2/N2 require the following:

Speed limiter: All M2/N2 vehicles are legally required to be speed limited. M2 to 62mph and N2 to 56mph.

Driver licence: Commercial vehicles with GVW greater than 3.5 tonnes have different license requirements. For any new drivers C1 category

is necessary. Under some circumstances (social purposes for a non-commercial body) it is possible to drive a minibus without a D1 entitlement (Minibus) however eligibility for this exemption should be confirmed with DVSA.

Driver CPC: Driver Certificate of Professional Competence mandates 35 hours of periodic training every 5 years to maintain licence (from September 2014).

Tachograph: It is a legal requirement to administer the activities of drivers subject to the EU or AETR drivers' hours rules, and also record the vehicle's speed, distance and time. A Smart Card is required for digital tachograph and these are available from the DVLA. The tachograph of a new vehicle must be calibrated within two weeks of first registration.

Operator's Licence: This may also be required to ensure that vehicles are kept safe and in good condition at all times. Specifically for M2, PSV (public service vehicle) operator's licence is required. Exemptions in some circumstances may be permitted but this should always be confirmed with DVSA.

MOT Testing: M2/N2 must be tested each year, and vehicle presented with a completed Certificate of Conformity (CoC). This is available from Vauxhall (regdata@gm.com) or from converter in case of second-stage conversion.

CUSTOMER CARE PRICING AND ADDITIONAL INFORMATION

Vauxhall on-the-road recommended retail prices (RRP)

To eliminate uncertainty about hidden costs incurred when buying a new commercial vehicle, Vauxhall publishes on-the-road prices and these are shown in the pricing tables within this price guide. The prices shown are manufacturer's recommended retail prices (RRP) unless otherwise stated, exclusive of VAT (currently at a rate of 20% which may be payable). These prices include the recommended cost of number plates, delivery to a Vauxhall Retailer of £583.33 (£700.00 including VAT), 12 months' Government Vehicle Excise Duty* and the DVLA new vehicle first registration fee of £55.00*.

Please note: The RRP does not include fuel supplied by the Retailer, motor insurance or any other goods or services supplied by agreement between the Retailer and customer.

Price protection for all Vauxhalls

Order a new Vauxhall for build in the current model year (as confirmed by your Retailer) for delivery no more than three months in advance and the price you are quoted is the price you pay. This is irrespective of any subsequent price rises between placing your order and delivery of your new commercial vehicle, but you must take delivery as soon as the commercial vehicle is available. Vauxhall Motors Limited is not liable for price adjustments caused by Government changes in the rate of VAT (currently 20%), Vehicle Excise Duty, DVLA new vehicle first registration fee or by any other applicable legislation or regulations.

Vehicle Excise Duty

The amount of Vehicle Excise Duty (road fund licence) payable on new commercial vehicles varies depending on gross vehicle weight (GVW) and European standard emissions compliance, as shown below*.

Up to 3500kg GVW	£250.00
Over 3500kg GVW	£165.00

*Correct at time of publication.

In the event of an accident...

Vauxhall Accident Management helps keep you mobile following an accident. Benefits include vehicle recovery, Vauxhall-approved repairs and contacting your insurer. For more details, visit vauxhall.co.uk/AccidentManagement

Customer Care Commitment

For added peace of mind, Vauxhall has an innovative Customer Care Commitment** that offers the following:

- Three-year vehicle warranty consisting of a one-year/unlimited mileage manufacturer's warranty and a second and third year manufacturer's warranty with a 60,000 miles (Corsavan and Combo) and 100,000 miles (Vivaro and Movano) limitation
 - Vauxhall Assistance for 12 months from first registration
 - Six years' body panel anti-perforation warranty
- ** Warranty is only on vehicles sourced from Vauxhall Motors Limited. Terms and conditions apply – please see your Vauxhall Retailer for details.

Vauxhall Assistance

Vauxhall Assistance is provided automatically with every new Vauxhall Commercial Vehicle for 12 months from first registration and covers everything from accidents, mechanical breakdown to flat tyres. With Vauxhall Assistance help is literally just a free† phone call away, 24 hours a day, 365 days a year!

† Mobile phone users will be charged at their standard tariff.

Vauxhall Extended Warranty

For complete peace of mind Vauxhall offers an extended warranty that can be purchased on an annual basis following the expiry of the original new vehicle warranty. It covers most mechanical and electrical components. Terms and conditions apply, for further details please contact your local Vauxhall Retailer.

Protecting the environment

Our products are increasingly winning environmental awards, both through the use of more recycled materials and by becoming cleaner and more efficient. For information on Vauxhall's efforts to achieve an environmentally sustainable future, including information on Design for Recycling, take-back of End-of-Life Vehicles (ELVs), and the recycling of ELVs, see www.vauxhall.co.uk/recycling

Vauxhall Service Plan

Vauxhall Retailers offer a great service for owners of all Vauxhall vehicles. Value for money, regular offers and free check-ups, combined with the peace of mind that comes from using Vauxhall-trained technicians and genuine parts, help keep your vehicle in peak condition at all times. Every Vauxhall Retailer supports our customer promise:

We are Vauxhall experts

- Fully Vauxhall-trained technicians
- We use Vauxhall approved diagnostic equipment and specialist tools
- Full access to Vauxhall repair databases and technical centres

We are transparent

- Our invoicing will clearly set out the work at the price agreed with no hidden extras

We are never beaten on price

- We will match any written like for like service/repair quote from a local†† competitor using genuine repair methods and parts

We are convenient

- Flexible booking times to suit you
- 'One-stop shop' for every type of Vauxhall service
- While you wait facility on stocked tyres, batteries and exhausts
- Free courtesy vehicle or local collection with annual services and warranty work

We are thorough

- 25 point safety check with any workshop visit
- No obligation advice on essential and non-essential work
- Free check for safety enhancements and upgrades to your vehicle and software
- Free 'Wash and Vac' with every annual service
- Free fitting of wipers and external bulbs with annual services

†† A radius of five miles/20 minutes from your Vauxhall Retailer.

Premier Van Centres

To maximise mobility and minimise downtime, our dedicated network of over 100 Premier Van Centres is increasing its emphasis on faster turnaround and fewer vehicle days spent off-road. We're your commercial vehicle 'one-stop shop' with all the specialised equipment, tools and training to support your aftersales needs, using only genuine parts fitted by Vauxhall-trained technicians. What's more, we promise convenience, expertise and value:

- Drop in for a diagnosis, no appointment necessary
- While-you-wait repairs where the parts are on-site
- A 25-point vehicle safety check with every workshop visit
- Access to Class 7 MOT facilities
- Onward mobility and a dedicated Premier Van Helpline – call 0800 026 0034

CORSAVAN SPECIFICATIONS

ENGINES

	1.2i (70PS)	1.3CDTi (75PS) Start/Stop	1.3CDTi (95PS) Start/Stop ecoTEC	1.3CDTi (95PS) Start/Stop
Fuel type	Petrol	Diesel	Diesel	Diesel
Capacity	1229cc	1248cc	1248cc	1248cc
Maximum power	70PS (51kW) @ 5600rpm	75PS (55kW) @ 3750rpm	95PS (70kW) @ 3750rpm	95PS (70kW) @ 3750rpm
Maximum torque	115Nm (85 lb.ft.) @ 4000rpm	190Nm (140 lb.ft.) @ 1500-2500rpm	190Nm (140 lb.ft.) @ 1500-3500rpm	210Nm (155 lb.ft.) @ 1500-3000rpm
Configuration	4 cylinders, 4 valves per cylinder, double overhead camshafts			
Fuel/induction system	Naturally aspirated with Variable Valve Timing. Multi-point sequential fuel injection	Turbocharger with intercooler. Common rail fuel injection	Variable geometry turbocharger with intercooler. Common rail fuel injection	
Emission compliance	Euro 6	Euro 6 with Diesel Particulate Filter		
Service interval	20,000 miles or 1-year (whichever occurs sooner)			

PLATED WEIGHTS AND TOWING DATA KG – CAR-DERIVED VAN

Model		Gross Vehicle Weights (GVW)	Plated weights		Towing weights		Plated Gross Combination Weights (GCW)
			Front axle	Rear axle	Braked	Unbraked	
Corsavan	1.2i	1605	815	820	950	540	2555
	1.3CDTi	1695	905	820	1200	580	2895
	1.3CDTi ecoTEC	1695	905	820	1250	580	2945
	1.3CDTi Sportive	1720	930	820	1250	600	2970
	1.3CDTi ecoTEC Easytronic	1705	915	820	1250	580	2955

Gross plated weights (including axle weights) quoted on the vehicle plate are to UK plated weight specification and must never be exceeded. For further information please see Glossary of Terms.

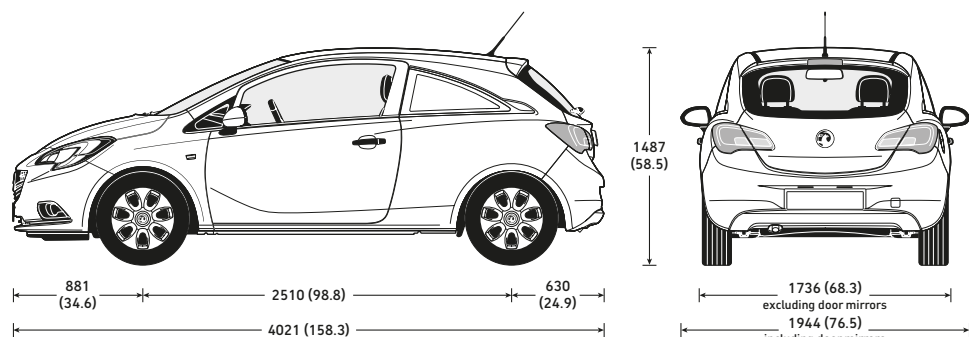

Dimensions mm (inches). Height shown unladen.

LOADSPACE DIMENSIONS MM (INCHES)

Maximum length	1257 (49.5)
Maximum width	1264 (49.8)
Width between wheel arches	969 (38.1)
Maximum height	921 (36.2)

LOADSPACE ACCESS MM (INCHES)

Aperture height	650 (25.6)
Aperture width (at floor)	771 (30.3)
Loading height (unladen)	532 (20.9)

LOADSPACE VOLUMES CU.M (CU.FT.)

All models – ECIE method	0.92 (32.5)
--------------------------	-------------

COMBO SPECIFICATIONS

ENGINES

	1.4i 95PS with Start/Stop	1.3CDTi 95PS with or without Start/Stop	1.6CDTi 105PS with or without Start/Stop
Fuel type	Petrol	Diesel	Diesel
Capacity	1368cc	1248cc	1598cc
Maximum power	95PS (70kW) @ 6000rpm	95PS (70kW) @ 3500 – 3750 rpm	105PS (77kW) @ 3500rpm
Maximum torque	127Nm (94 lb.ft.) @ 4500rpm	200Nm (148 lb.ft.) @ 1500rpm	300Nm (221 lb.ft.) @ 1750 – 2000rpm
Configuration	4 cylinders, 4 valves per cylinder, double overhead camshafts		
Fuel/induction system	Multi-point fuel injection	Variable geometry turbocharger with intercooler. Common rail fuel injection	
Emission compliance	Euro 6		
Service interval	18,000 miles or two years (whichever occurs sooner)	20,000 miles or two years (whichever occurs sooner)	

COMBO PANEL VAN SPECIFICATIONS

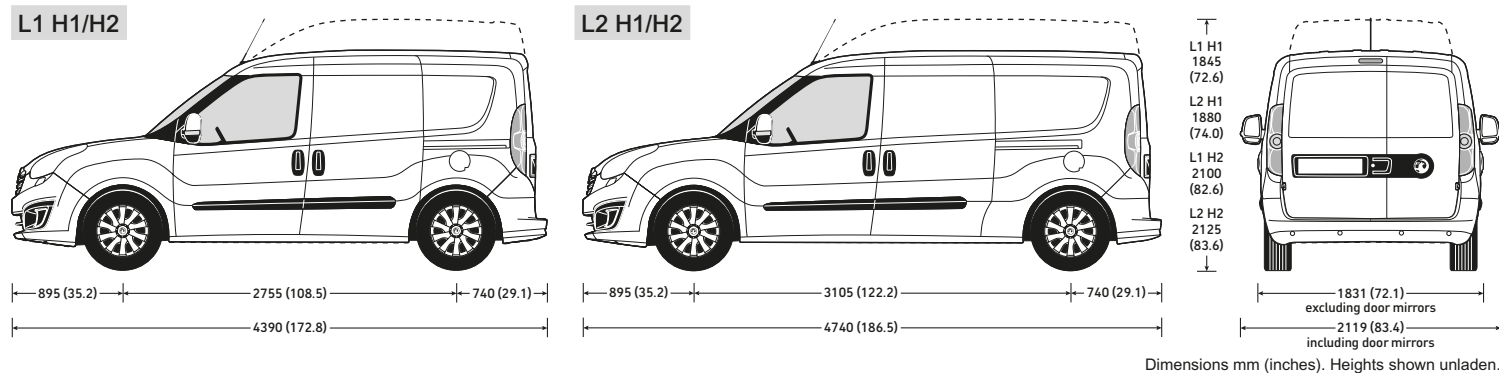

LOADSPACE DIMENSIONS MM (INCHES) – PANEL VAN

	L1	L2
Maximum length	1820 (71.7)	2170 (85.4)
Maximum width	1714 (67.5)	1714 (67.5)
Width between wheel arches	1230 (48.4)	1230 (48.4)
Maximum height – H1	1305 (51.4)	1305 (51.4)
Maximum height – H2	1550 (61.0)	1550 (61.0)

LOADSPACE ACCESS MM (INCHES) – PANEL VAN

	L1	L2
Side door aperture height	1175 (46.2)	1175 (46.2)
Side door aperture width	700 (27.5)	700 (27.5)
Rear door aperture height – H1	1250 (49.2)	1250 (49.2)
Rear door aperture height – H2	1455 (57.2)	1455 (57.2)
Rear door aperture width	1231 (48.5)	1231 (48.5)
Loading height (unladen)	545 (21.4)	545 (21.4)

PLATED WEIGHTS AND TOWING DATA KG – PANEL VAN

Model		Gross Vehicle Weights (GVW)	Plated weights		Towing weights		Plated Gross Combination Weights (GCW)
			Front axle	Rear axle	Braked	Unbraked	
L1 H1 Panel Van	2000 1.4i	2030	1090	1140	1000	500	3030
	2000 1.3CDTi	2040	1090	1140	1000	500	3040
	2000 1.6CDTi	2098	1090	1140	1300	500	3398
	2300 1.3CDTi	2320	1090	1450	1000	500	3320
	2300 1.6CDTi	2418	1200	1450	1300	500	3500
L2 H1 Panel Van	2300 1.4i	2215	1090	1450	1000	500	3215
	2300 1.3CDTi	2385	1120	1450	1000	500	3385
	2300 1.6CDTi	2458	1200	1450	1300	500	3500
L1 H2 Panel Van	2000 1.6CDTi	2120	1090	1140	1300	500	3420
	2300 1.6CDTi	2428	1200	1450	1300	500	3500
L2 H2 Panel Van	2300 1.6CDTi	2488	1200	1450	1300	500	3500

Gross plated weights (including axle weights) quoted on the vehicle plate are to UK plated weight specification and must never be exceeded. For further information please see Glossary of Terms.

LOADSPACE VOLUMES CU.M (CU.FT.) – PANEL VAN

	L1	L2
H1 Panel Van	3.4 (121)	4.2 (148)
H2 Panel Van	4.0 (141)	5.0 (177)

COMBO CREW VAN SPECIFICATIONS

L1/L2 H1

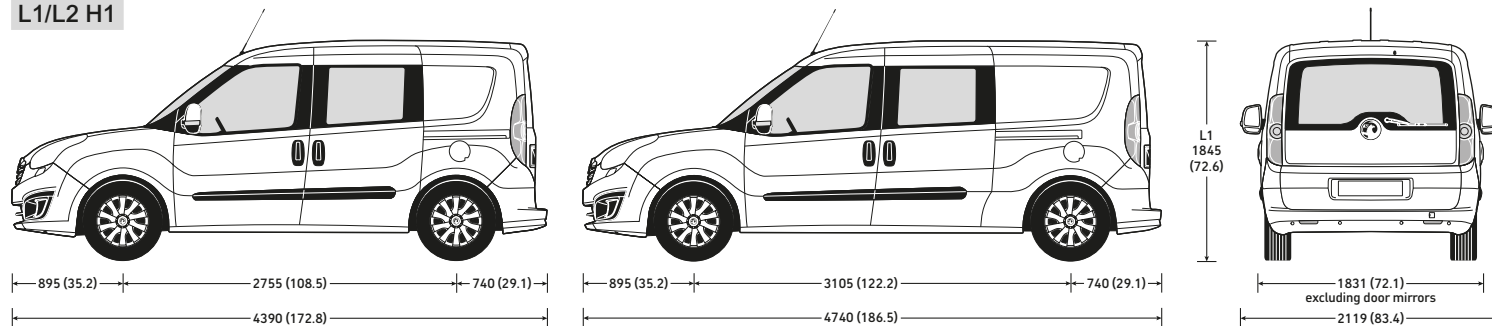

Please note, Glazed Crew Van illustrated. Height shown unladen.

LOADSPACE DIMENSIONS MM (INCHES) – CREW VAN

	L1	L2
Maximum length – with seats up	991 (39.0)	1341 (52.8)
Maximum length – with seats down	1400 (55.1)	1750 (68.9)
Maximum width	1714 (67.5)	1714 (67.5)
Width between wheel arches	1230 (48.4)	1230 (48.4)
Maximum height	1305 (51.4)	1305 (51.4)

LOADSPACE ACCESS MM (INCHES) – CREW VAN

	L1	L2
Side door aperture height	1175 (46.2)	1175 (46.2)
Side door aperture width	700 (27.5)	700 (27.5)
Rear door aperture height	1250 (49.2)	1250 (49.2)
Rear door aperture width	1231 (48.5)	1231 (48.5)
Loading height (unladen)	545 (21.4)	545 (21.4)

LOADSPACE VOLUMES CU.M (CU.FT.) – CREW VAN

	L1 H1	L2 H1
Crew Van – with seats up (to top of seats)	0.8 (28.2)	1.0 (35.3)
Crew Van – with seats up (to roof)	1.4 (49.4)	1.9 (67.1)

PLATED WEIGHTS AND TOWING DATA KG – CREW VAN / COLORADO

Model	Gross Vehicle Weights (GVW)	Plated weights		Towing weights		Plated Gross Combination Weights (GCW)	
		Front axle	Rear axle	Braked	Unbraked		
L1 H1 Crew Van	2300 1.3CDTi	2234	1090	1310	1000	500	3234
	2300 1.6CDTi	2254	1090	1310	1300	500	3398
L2 H1 Crew Van	2300 1.3CDTi	2254	1120	1310	1000	500	3254
	2300 1.6CDTi	2349	1200	1310	1300	500	3500
L2 H1 Colorado	2300 1.3CDTi	2254	1120	1310	1000	500	3254

Gross plated weights (including axle weights) quoted on the vehicle plate are to UK plated weight specification and must never be exceeded. For further information please see Glossary of Terms.

VIVARO SPECIFICATIONS



DIESEL ENGINES

	1.6CDTi (95PS) BlueInjection with or without Start/Stop	1.6CDTi (120PS) BlueInjection
Capacity	1598cc	1598cc
Maximum power	95PS (70kW) @ 3500rpm	120PS (89kW) @ 3500rpm
Maximum torque	260Nm (192 lb.ft.) @ 1500rpm	300Nm (221 lb.ft.) @ 1750rpm
Configuration	4 cylinders, 4 valves per cylinder, double overhead camshafts	
Fuel/induction system	Variable geometry turbocharger with intercooler. Common rail fuel injection	
Emission compliance	Euro 6	
Service interval	25,000 miles or two-years (whichever occurs sooner)	

	1.6CDTi BiTurbo (125PS) ecoTEC BlueInjection Start/Stop	1.6CDTi BiTurbo (145PS) BlueInjection Start/Stop
Capacity	1598cc	1598cc
Maximum power	125PS (92kW) @ 3500rpm	145PS (107kW) @ 3500rpm
Maximum torque	320Nm (236 lb.ft.) @ 1500rpm	340Nm (251 lb.ft.) @ 1750rpm
Configuration	4 cylinders, 4 valves per cylinder, double overhead camshafts	
Fuel/induction system	Twin variable geometry turbochargers with intercoolers. Common rail fuel injection	
Emission compliance	Euro 6	
Service interval	25,000 miles or two-years (whichever occurs sooner)	

* = Please note: Vehicles with BlueInjection technology will need regular AdBlue® top-ups also between servicing requirements. An indicator integrated into the onboard computer will warn you when you need to top up. More information under www.vauxhall.co.uk/blueinjection. In accordance with regulations R (EC) No. 715/2007 and R (EC) No. 692/2008 (in the versions respectively applicable).

TYRE RATINGS

Tyre size	Fuel efficiency group	Wet grip performance	External noise	
			Measured (dB)	Group
205/65 R 16	C-E	B-E	71-72	
215/65 R 16	C	B	70	
215/60 R 17	C	B	70	

Tyre rating according to EU Regulation 1222/2009

VIVARO PANEL VAN SPECIFICATIONS

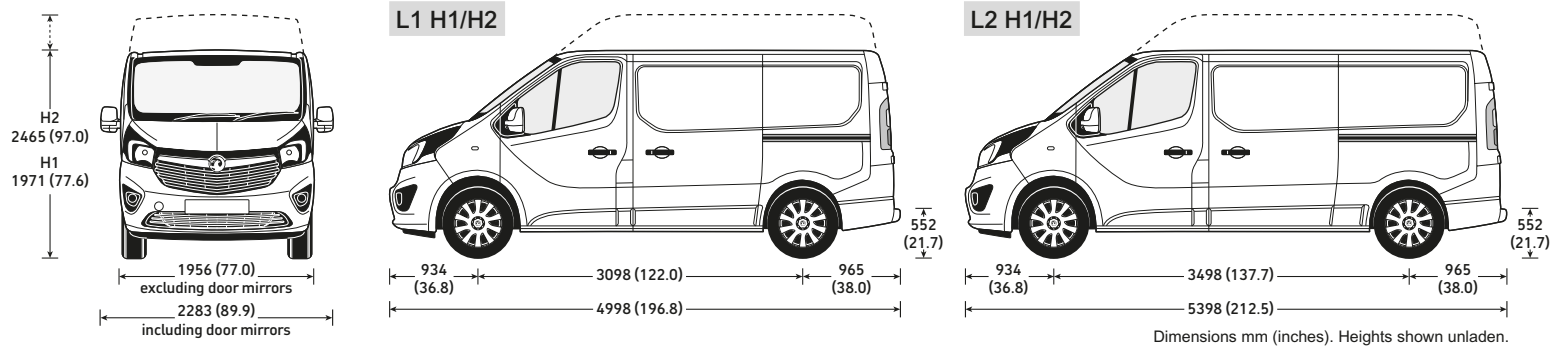

LOADSPACE DIMENSIONS MM (INCHES) – PANEL VAN

	L1	L2
Maximum length at load floor	2537 (99.9)	2937 (115.6)
Maximum length with load-through facility maximum length to seat – <i>Approximate</i> .	2967 (116.8)	3367 (132.5)
Maximum length with load-through facility maximum length to front footwell – <i>Approximate</i> .	3750 (147.6)	4150 (163.4)
Maximum width	1662 (65.5)	1662 (65.5)
Width between wheel arches	1268 (49.9)	1268 (49.9)
Maximum height - H1	1387 (54.6)	1387 (54.6)
Maximum height - H2	1898 (74.7)	1898 (74.7)

LOADSPACE ACCESS MM (INCHES) – PANEL VAN

	L1	L2
Side door aperture height	1284 (50.5)	1284 (50.5)
Side door aperture width	1030 (40.5)	1030 (40.5)
Rear door aperture height – H1	1320 (52.0)	1320 (52.0)
Rear door aperture height – H2	1820 (71.6)	1820 (71.6)
Rear door aperture width	1391 (54.8)	1391 (54.8)
Loading height (unladen)	552 (21.7)	552 (21.7)

PLATED WEIGHTS AND TOWING DATA KG – PANEL VAN

Model		Gross Vehicle Weights (GVW)	Plated weights		Towing weights		Plated Gross Combination Weights (GCW)
			Front axle	Rear axle	Braked	Unbraked	
L1 H1/H2 Panel Van	2700	2800	1585	1650	2000	750	4800
	2700 BiTurbo	2820	1585	1650	2000	750	4820
	2900	2960	1585	1650	2000	750	4960
	2900 BiTurbo	2980	1585	1650	2000	750	4980
L2 H1 Panel Van	2900	3030	1585	1650	2000	750	5030
	2900 BiTurbo	3040	1585	1650	2000	750	5040
L2 H2 Panel Van	2900 BiTurbo	3070	1585	1650	2000	750	5070

Gross plated weights (including axle weights) quoted on the vehicle plate are to UK plated weight specification and must never be exceeded. For further information please see Glossary of Terms.

LOADSPACE VOLUMES CU.M (CU.FT.) – PANEL VAN

	L1	L2
H1 Panel Van	5.2 (183.6)	6.0 (211.9)
H2 Panel Van	7.2 (254.3)	8.6 (303.7)

VIVARO DOUBLECAB SPECIFICATIONS

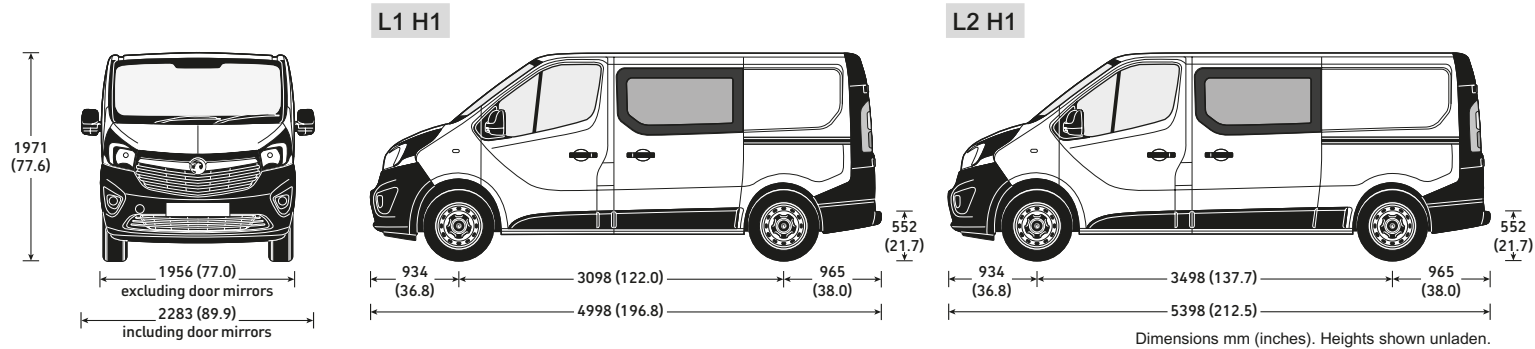

LOADSPACE DIMENSIONS MM (INCHES) – DOUBLECAB

	L1	L2
Maximum length at load floor	2023 (79.6)	2423 (95.4)
Maximum length behind rear seats	1340 (42.7)	1740 (68.5)
Maximum width	1662 (65.5)	1662 (65.5)
Width between wheel arches	1268 (49.9)	1268 (49.9)
Maximum height	1387 (54.6)	1387 (54.6)

LOADSPACE ACCESS MM (INCHES) – DOUBLECAB

	L1	L2
Side door aperture height	1284 (50.5)	1284 (50.5)
Side door aperture width	1030 (40.5)	1030 (40.5)
Rear door aperture height	1320 (52.0)	1320 (52.0)
Rear door aperture width	1391 (54.8)	1391 (54.8)
Loading height (unladen)	552 (21.7)	552 (21.7)

LOADSPACE VOLUMES CU.M (CU.FT.) – DOUBLECAB

	L1	L2
Doublecab	3.2 (113.0)	4.0 (141.3)

PLATED WEIGHTS AND TOWING DATA KG – DOUBLECAB

Model		Gross Vehicle Weights (GVW)	Plated weights		Towing weights		Plated Gross Combination Weights (GCW)
			Front axle	Rear axle	Braked	Unbraked	
L1 H1 Doublecab	2900	2834	1585	1650	2000	750	4834
	2900 BiTurbo	2844	1585	1650	2000	750	4844
L2 H1 Doublecab	2900	2940	1585	1650	2000	750	4940
	2900 BiTurbo	2950	1585	1650	2000	750	4950

Gross plated weights (including axle weights) quoted on the vehicle plate are to UK plated weight specification and must never be exceeded. For further information please see Glossary of Terms.

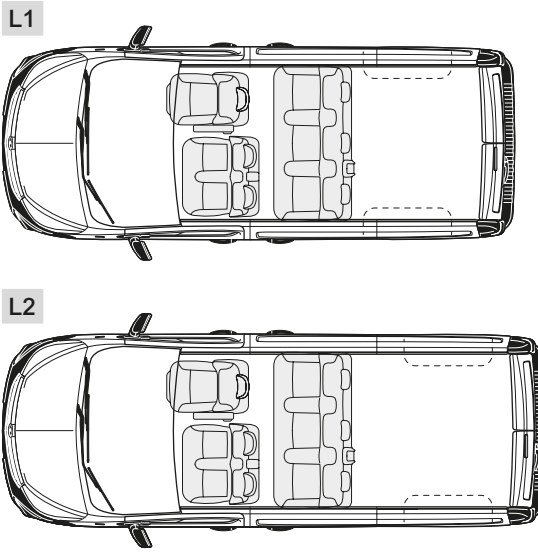

VIVARO COMBI SPECIFICATIONS

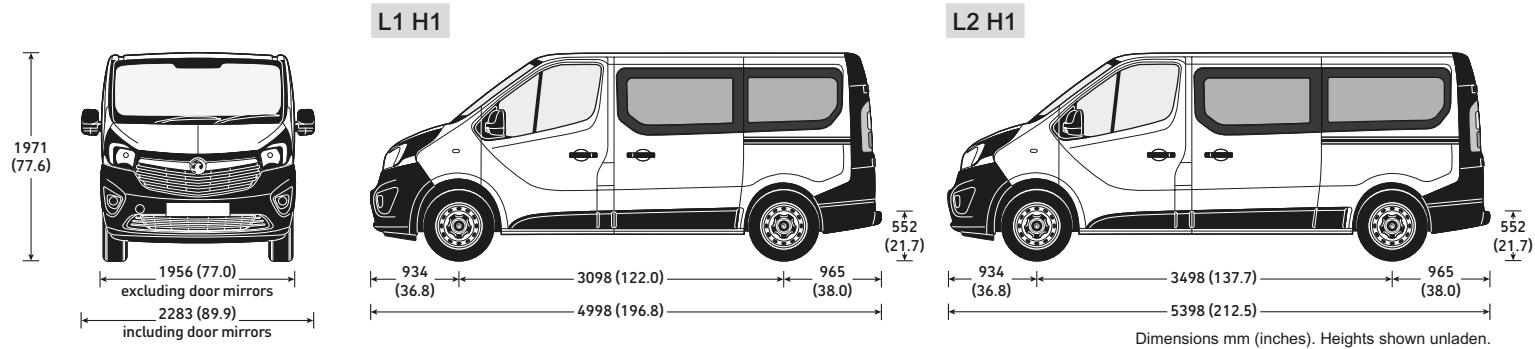

LOADSPACE DIMENSIONS MM (INCHES) – COMBI

	L1	L2
Maximum length behind rear seats	736 (30.0)	1136 (44.7)
Maximum width	1662 (65.5)	1662 (65.5)
Width between wheel arches	1268 (49.9)	1268 (49.9)
Maximum height	1369 (53.9)	1369 (53.9)

LOADSPACE ACCESS MM (INCHES) – COMBI

	L1	L2
Side door aperture height	1284 (50.5)	1284 (50.5)
Side door aperture width	1030 (40.5)	1030 (40.5)
Rear door aperture height	1320 (52.0)	1320 (52.0)
Rear door aperture width (at floor)	1391 (54.8)	1391 (54.8)
Loading height (unladen)	552 (21.7)	552 (21.7)

LOADSPACE VOLUMES CU.M (CU.FT.) – COMBI

	L1	L2
Combi	1.0 (35.3)	1.8 (63.6)
Combi – third-row seats down	2.1 (74.2)	2.9 (102.4)
Combi – third-row seats removed	3.2 (113.0)	4.0 (141.3)

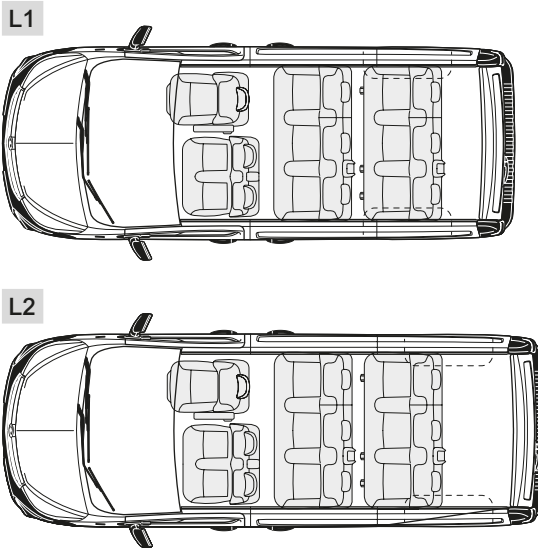

PLATED WEIGHTS AND TOWING DATA KG – COMBI

Model		Gross Vehicle Weights (GVW)	Plated weights		Towing weights		Plated Gross Combination Weights (GCW)
			Front axle	Rear axle	Braked	Unbraked	
L1 H1 Combi	2900	2925	1585	1650	2000	750	4925
	2900 BiTurbo	2935	1585	1650	2000	750	4935
L2 H1 Combi	2900	3010	1585	1650	2000	750	5010
	2900 BiTurbo	3020	1585	1650	2000	750	5020
L1 H1 / L2 H1 Combi+	2900 / 2900 BiTurbo	3030	1585	1650	2000	750	5030

Gross plated weights (including axle weights) quoted on the vehicle plate are to UK plated weight specification and must never be exceeded. For further information please see Glossary of Terms.

VIVARO PLATFORM CAB SPECIFICATIONS

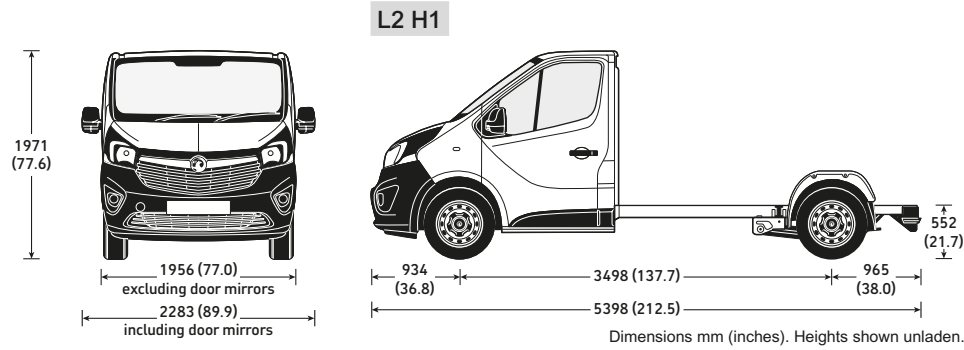

Platform cabs

Platform cabs are ideal for those conversions requiring a low floor and walk-through access from the cab. The interface panel makes for easy integration of the cab with the conversion body, while an extended-length wiring loom is available to power the rear lights or extended conversions.

All conversions must follow 'Conversion Requirements' guidelines available on:
www.vauxhall.co.uk/conversiondata

PLATED WEIGHTS AND TOWING DATA KG – PLATFORM CAB

Model	Gross Vehicle Weights (GVW)	Plated weights		Towing weights		Plated Gross Combination Weights (GCW)	
		Front axle	Rear axle	Braked	Unbraked		
L2 H1 Platform Cab	2900 BiTurbo	3030	1585	1735	2000	750	5030

Gross plated weights (including axle weights) quoted on the vehicle plate are to UK plated weight specification and must never be exceeded. For further information please see Glossary of Terms.

MOVANO SPECIFICATIONS

DIESEL ENGINES

	2.3CDTi (110PS) BlueInjection	2.3CDTi (130PS) BlueInjection	2.3CDTi BiTurbo (130PS) BlueInjection	2.3CDTi BiTurbo (145PS) BlueInjection with Start/Stop
Capacity	2298cc	2298cc	2298cc	2298cc
Maximum power	110PS (81kW) @ 3500rpm	130PS (96kW) @ 3500rpm	130PS (96kW) @ 3500rpm	145PS (107kW) @ 3500rpm
Maximum torque	290Nm (214 lb.ft.) @ 1500rpm	320Nm (236 lb.ft.) @ 1500rpm	330Nm (243 lb.ft.) @ 1500rpm	360Nm (266 lb.ft.) @ 1500rpm
Configuration	4 cylinders, 4 valves per cylinder, double overhead camshafts			
Fuel/induction system	Fixed geometry turbocharger and intercooler. Common rail fuel injection		Twin variable geometry turbochargers and intercoolers. Common rail fuel injection	
Emission compliance	Euro 6	Euro 6	Euro VI	Euro 6 (FWD) / Euro VI (RWD)
Service interval	25,000 miles (20,000 miles on Minibus models) or two years (whichever occurs sooner)			

	2.3CDTi BiTurbo (163PS) BlueInjection with Start/Stop	2.3CDTi BiTurbo (170PS) BlueInjection with Start/Stop
Capacity	2298cc	2298cc
Maximum power	163PS (120kW) @ 3500rpm	170PS (125kW) @ 3500rpm
Maximum torque	360Nm (266 lb.ft.) @ 1500-2750rpm	380Nm (280 lb.ft.) @ 1500rpm
Configuration	4 cylinders, 4 valves per cylinder, double overhead camshafts	
Fuel/induction system	Twin variable geometry turbochargers and intercoolers. Common rail fuel injection	
Emission compliance	Euro VI	Euro 6
Service interval	25,000 miles or two years (whichever occurs sooner)	

Vehicles with BlueInjection technology will need regular AdBlue® top-ups also between servicing requirements. An indicator integrated into the on-board computer will warn you when you need to top up. More information under www.vauxhall.co.uk/blueinjection. In accordance with regulations R (EC) No. 715/2007 and R (EC) No. 692/2008 (in the versions respectively applicable).

MOVANO FWD PANEL VAN SPECIFICATIONS

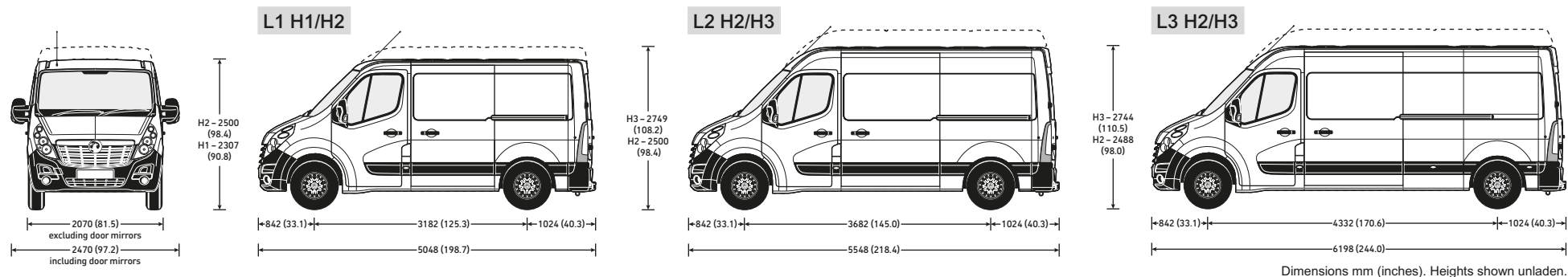

LOADSPACE DIMENSIONS MM (INCHES) – FWD PANEL VAN

	L1	L2	L3
Maximum length	2583 (101.7)	3083 (121.4)	3733 (147.0)
Maximum width	1765 (69.5)	1765 (69.5)	1765 (69.5)
Width between wheel arches	1380 (54.3)	1380 (54.3)	1380 (54.3)
Maximum height – H1	1700 (66.9)	–	–
Maximum height – H2	1894 (74.6)	1894 (74.6)	1894 (74.6)
Maximum height – H3	–	2144 (84.4)	2144 (84.4)

LOADSPACE ACCESS MM (INCHES) – FWD PANEL VAN

	L1	L2	L3
Side door aperture height – H1	1581 (62.2)	–	–
Side door aperture height – H2/H3	1780 (70.1)	1780 (70.1)	1780 (70.1)
Side door aperture width	1050 (41.3)	1270 (50.0)	1270 (50.0)
Rear door aperture height – H1	1627 (64.0)	–	–
Rear door aperture height – H2/H3	1820 (71.7)	1820 (71.7)	1820 (71.7)
Rear door aperture width	1577 (62.1)	1577 (62.1)	1577 (62.1)
Loading height (unladen)	563 (22.2)	562 (22.1)	557 (21.9)

PLATED WEIGHTS AND TOWING DATA KG – PANEL VAN

Model		Gross Vehicle Weights (GVW)	Plated weights		Towing weights		Plated Gross Combination Weights (GCW)
			Front axle	Rear axle	Braked	Unbraked	
L1 H1/H2 Panel Van	F2800	2800	1550	1650	2500	750	5300
	F3300	3300	1650	1900	2500	750	5800
	F3500	3500	1850	2100	2500	750	6000
L2 H2/H3 Panel Van	F3300	3300	1700	1900	2500	750	5800
	F3500	3500	1850	2100	2500	750	6000
L3 H2/H3 Panel Van	F3500	3500	1850	2100	2500	750	6000

Gross plated weights (including axle weights) quoted on the vehicle plate are to UK plated weight specification and must never be exceeded. For further information please see Glossary of Terms.

LOADSPACE VOLUMES CU.M (CU.FT.) – FWD PANEL VAN

	L1 H1	L1 H2	L2 H2	L2 H3	L3 H2	L3 H3
Panel Van – Maximum	7.8 (275)	8.6 (304)	10.8 (381)	12.3 (434)	13.0 (459)	14.8 (523)
– VDA	7.0 (247)	–	9.4 (322)	–	11.3 (399)	–

MOVANO FWD DOUBLECAB SPECIFICATIONS

L2 H2

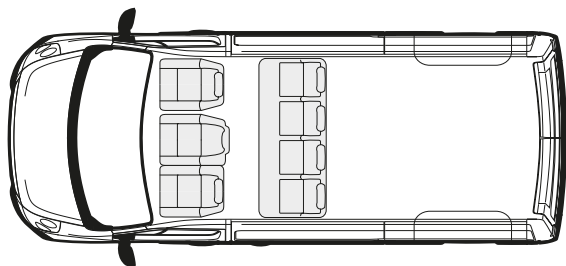

L3 H2

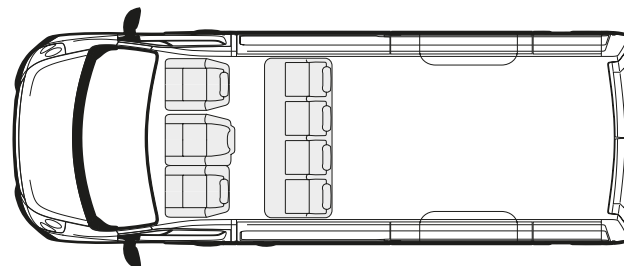

For exterior dimensions see FWD Panel Van.

LOADSPACE DIMENSIONS MM (INCHES) – FWD DOUBLECAB

	L2	L3
Maximum length at load floor	2175 (85.6)	2825 (111.2)
Maximum length behind rear seats	1990 (78.3)	2640 (103.9)
Maximum width	1765 (69.5)	1765 (69.5)
Width between wheel arches	1380 (54.3)	1380 (54.3)
Maximum height	1894 (74.6)	1894 (74.6)

LOADSPACE ACCESS MM (INCHES) – FWD DOUBLECAB

	L2	L3
Side door aperture height	1780 (70.1)	1780 (70.1)
Side door aperture width	1270 (50.0)	1270 (50.0)
Rear door aperture height	1820 (71.7)	1820 (71.7)
Rear door aperture width	1577 (62.1)	1577 (62.1)
Loading height (unladen)	562 (22.1)	557 (21.9)

PLATED WEIGHTS AND TOWING DATA KG – DOUBLECAB

Model	Gross Vehicle Weights (GVW)	Plated weights		Towing weights		Plated Gross Combination Weights (GCW)
		Front axle	Rear axle	Braked	Unbraked	
L2 H2/L3 H2 Doublecab F3500	3500	1850	2100	2500	750	6000

Gross plated weights (including axle weights) quoted on the vehicle plate are to UK plated weight specification and must never be exceeded. For further information please see Glossary of Terms.

LOADSPACE VOLUMES CU.M (CU.FT.) – FWD DOUBLECAB

	L2 H2	L3 H2
Doublecab	6.9 (244)	9.0 (318)

MOVANO RWD DOUBLECAB SPECIFICATIONS

L3 H2

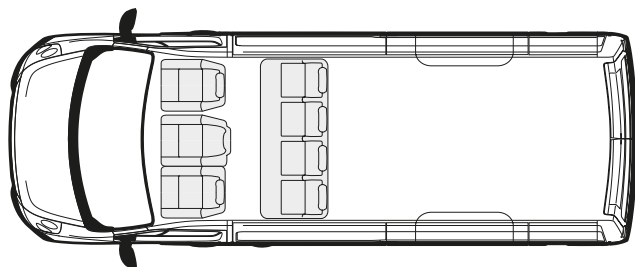

For exterior dimensions see RWD Panel Van.

LOADSPACE DIMENSIONS MM (INCHES) – RWD DOUBLECAB

	L3
Maximum length at load floor	2825 (111.2)
Maximum length behind rear seats	2640 (103.9)
Maximum width	1765 (69.5)
Width between wheel arches	1380 (54.3)
Maximum height	1798 (70.8)

LOADSPACE ACCESS MM (INCHES) – RWD DOUBLECAB

	L3
Side door aperture height	1684 (66.3)
Side door aperture width	1270 (50.0)
Rear door aperture height	1724 (67.9)
Rear door aperture width	1577 (62.1)
Loading heights (unladen)	674 (26.5) – 696 (27.4)

PLATED WEIGHTS AND TOWING DATA KG – DOUBLECAB

Model	Gross Vehicle Weights (GVW)	Plated weights		Towing weights		Plated Gross Combination Weights (GCW)	
		Front axle	Rear axle	Braked	Unbraked		
L3 H2 Doublecab	R3500	3500	1850	2300	2500	750	6000

Gross plated weights (including axle weights) quoted on the vehicle plate are to UK plated weight specification and must never be exceeded. For further information please see Glossary of Terms.

LOADSPACE VOLUMES CU.M (CU.FT.) – RWD DOUBLECAB

	L3 H2
Doublecab	8.4 (297)

MOVANO RWD PANEL VAN SPECIFICATIONS

L3 H2/H3

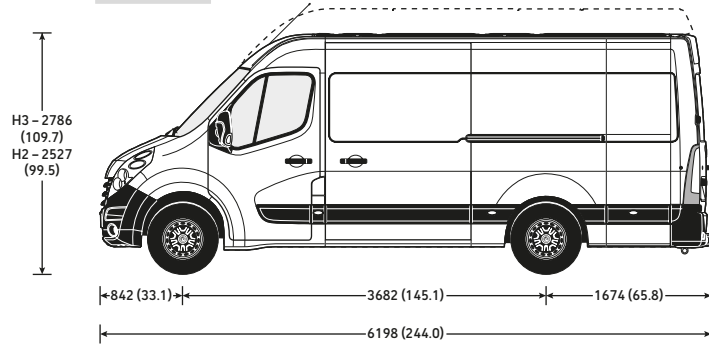

L4 H2/H3

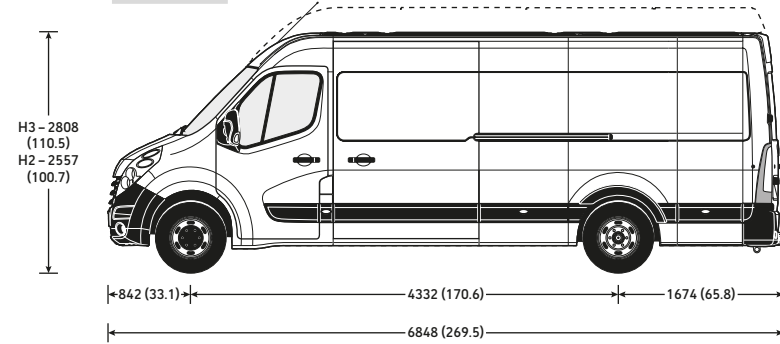

Dimensions mm (inches). Heights shown unladen.

LOADSPACE DIMENSIONS MM (INCHES) – RWD PANEL VAN

	L3	L4
Maximum length	3733 (147.0)	4383 (172.6)
Maximum width	1765 (69.5)	1765 (69.5)
Width between wheel arches	1380 (54.3)	1380 (54.3)
Maximum height – H2	1798 (70.8)	1798 (70.8)
Maximum height – H3	2048 (80.6)	2048 (80.6)

LOADSPACE ACCESS MM (INCHES) – RWD PANEL VAN

	L3	L4
Side door aperture height	1684 (66.3)	1684 (66.3)
Side door aperture width	1270 (50.0)	1270 (50.0)
Rear door aperture height	1724 (67.9)	1724 (67.9)
Rear door aperture width	1577 (62.1)	1577 (62.1)
Loading heights (unladen)	696 (27.4) – 724 (28.5)	717 (28.2)

PLATED WEIGHTS AND TOWING DATA KG – RWD PANEL VAN

Model	Gross Vehicle Weights (GVW)	Plated weights		Towing weights		Plated Gross Combination Weights (GCW)	
		Front axle	Rear axle	Braked	Unbraked		
L3 H2/H3 Panel Van	R3500	3500	1850	2300	2500	750	6000
L4 H2/H3 Panel Van	R3500	3500	1850	2300	2500	750	6000

Gross plated weights (including axle weights) quoted on the vehicle plate are to UK plated weight specification and must never be exceeded. For further information please see Glossary of Terms.

LOADSPACE VOLUMES CU.M (CU.FT.) – RWD PANEL VAN

	L3 H2	L3 H3	L4 H2	L4 H3
Panel Van – Maximum	12.4 (438)	14.2 (501)	14.9 (526)	17.0 (600)
– VDA	10.9 (385)	12.2 (431)	12.9 (456)	14.1 (498)

MOVANO RWD HD PANEL VAN SPECIFICATIONS

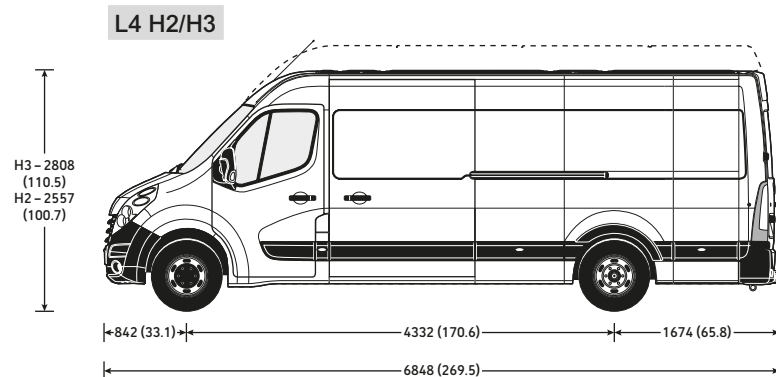
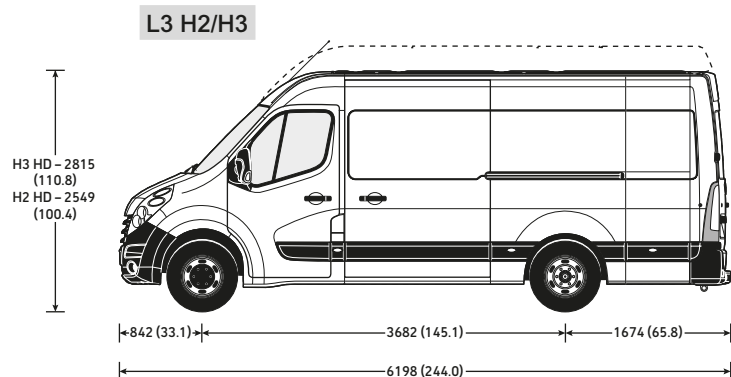

Dimensions mm (inches). Heights shown unladen.

LOADSPACE DIMENSIONS MM (INCHES) – RWD HD PANEL VAN

	L3	L4
Maximum length	3733 (147.0)	4383 (172.6)
Maximum width	1765 (69.5)	1765 (69.5)
Width between wheel arches	1080 (42.5)	1080 (42.5)
Maximum height – H2	1798 (70.8)	1798 (70.8)
Maximum height – H3	2048 (80.6)	2048 (80.6)

LOADSPACE ACCESS MM (INCHES) – RWD HD PANEL VAN

	L3	L4
Side door aperture height	1684 (66.3)	1684 (66.3)
Side door aperture width	1270 (50.0)	1270 (50.0)
Rear door aperture height	1724 (67.9)	1724 (67.9)
Rear door aperture width	1577 (62.1)	1577 (62.1)
Loading heights	723 (28.4) – 724 (28.5)	717 (28.2)

PLATED WEIGHTS AND TOWING DATA KG – RWD HD PANEL VAN

Model		Gross Vehicle Weights (GVW)	Plated weights		Towing weights		Plated Gross Combination Weights (GCW)
			Front axle	Rear axle	Braked	Unbraked	
L3 H2/H3 Panel Van	R3500HD	3500	1850	2800	3000	750	6500
L3 H2/H3 Panel Van	R4500HD	4500	1850	3200	3000	750	7500
L4 H2/H3 Panel Van	R3500HD	3500	1850	2800	3000	750	6500
L4 H2/H3 Panel Van	R4500HD	4500	1850	3200	3000	750	7500

Gross plated weights (including axle weights) quoted on the vehicle plate are to UK plated weight specification and must never be exceeded. For further information please see Glossary of Terms.

LOADSPACE VOLUMES CU.M (CU.FT.) – RWD HD PANEL VAN

	L3 H2	L3 H3	L4 H2	L4 H3
Panel Van – Maximum	12.4 (438)	14.2 (501)	14.9 (526)	17.0 (600)
– VDA	10.7 (378)	12.0 (424)	12.7 (448)	13.9 (491)

MOVANO TIPPER / CREW CAB TIPPER SPECIFICATIONS

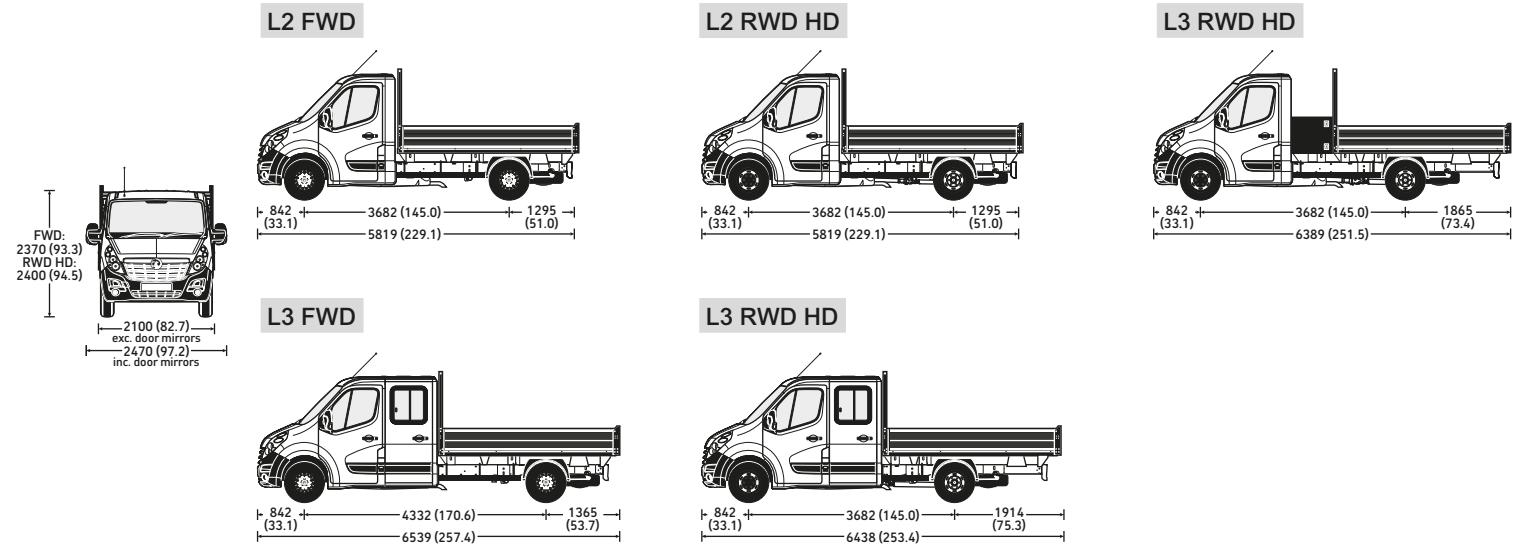

Dimensions mm (inches). Heights shown unladen.

LOADSPACE AREA DIMENSIONS MM (IN) – TIPPER			
	L2 FWD	L2 RWD HD	L3 RWD HD
Maximum length	3205 (126.2)	3205 (126.2)	3105 (122.2)
Maximum width	2040 (80.3)	2040 (80.3)	2040 (80.3)
Body side height	400 (15.7)	400 (15.7)	400 (15.7)
Loading height (unladen)	1090 (42.9)	1090 (42.9)	1090 (42.9)
Load area sq.m (sq.ft.)	6.5 (69.4)	6.5 (69.4)	6.3 (68.2)

LOADSPACE AREA DIMENSIONS MM (IN) – CREW CAB TIPPER		
	L3 FWD	L3 RWD HD
Maximum length	3205 (126.2)	3105 (122.2)
Maximum width	2040 (80.3)	2040 (80.3)
Body side height	400 (15.7)	400 (15.7)
Loading height (unladen)	1090 (42.9)	1090 (42.9)
Load area sq.m (sq.ft.)	6.5 (69.4)	6.3 (68.2)

MOVANO DROPSIDE SPECIFICATIONS

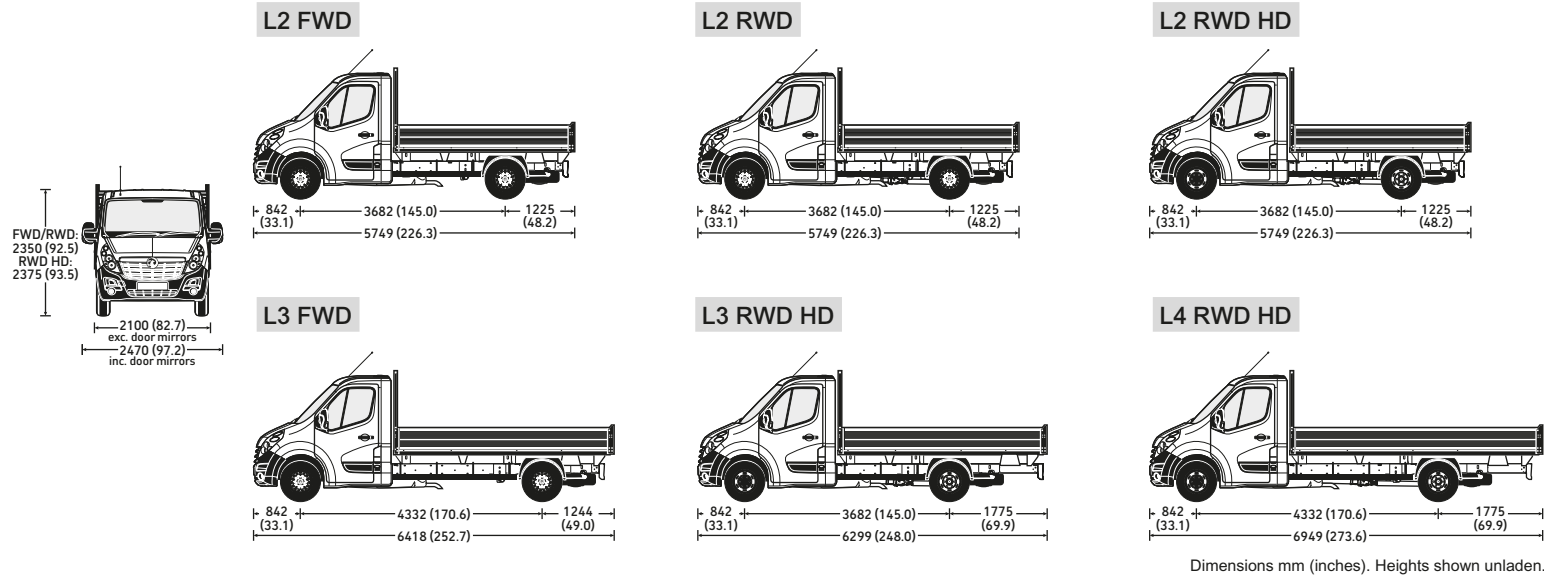

LOADSPACE AREA DIMENSIONS MM (IN) – DROPSIDE					
	L2 FWD	L3 FWD	L2 RWD / RWD HD	L3 RWD HD	L4 RWD HD
Maximum length	3170 (124.8)	3900 (153.5)	3170 (124.8)	3700 (145.7)	4470 (176.0)
Maximum width	2040 (80.3)	2040 (80.3)	2040 (80.3)	2040 (80.3)	2040 (80.3)
Body side height	400 (15.7)	400 (15.7)	400 (15.7)	400 (15.7)	400 (15.7)
Loading height (unladen)	1026 (40.4)	1026 (40.4)	1026 (40.4)	1026 (40.4)	1026 (40.4)
Load area sq.m (sq.ft.)	6.5 (70.0)	7.8 (83.9)	6.5 (70.0)	7.6 (81.8)	8.9 (95.8)

MOVANO DROPSIDE CREW CAB SPECIFICATIONS

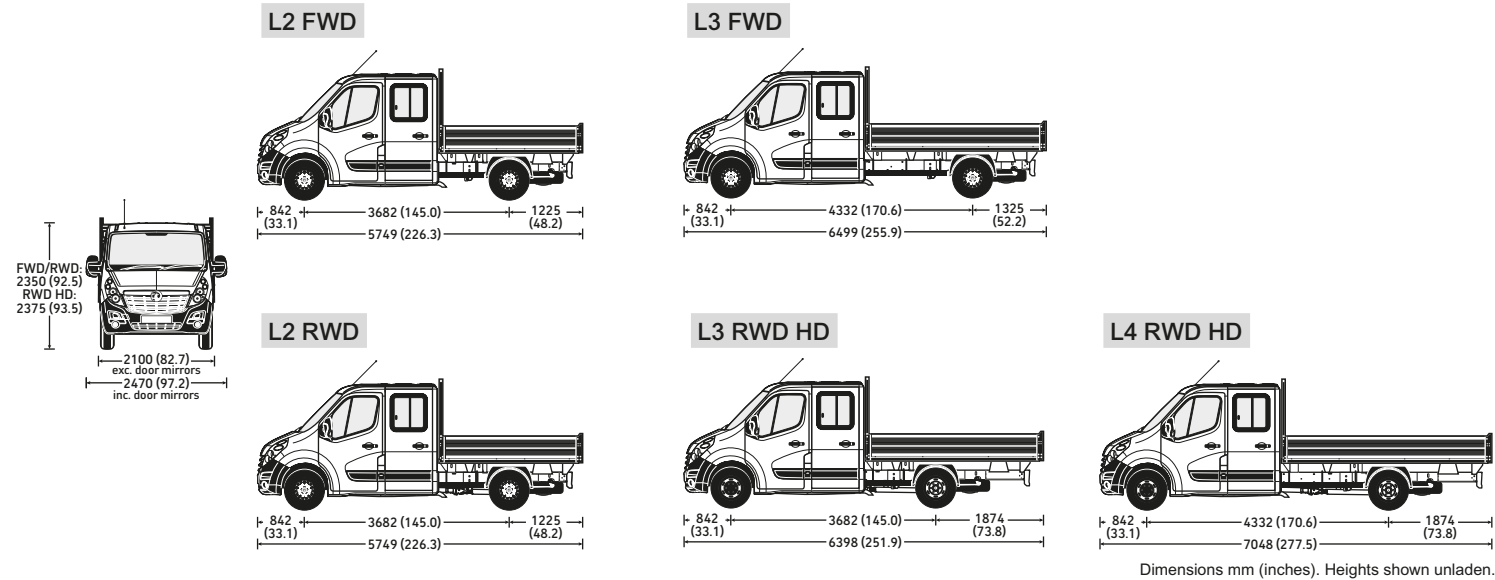

LOADSPACE AREA DIMENSIONS MM (IN) – DROPSIDE CREW CAB					
	L2 FWD	L3 FWD	L2 RWD	L3 RWD HD	L4 RWD HD
Maximum length	2501 (98.5)	3170 (124.8)	2501 (98.5)	3070 (120.9)	3702 (145.7)
Maximum width	2040 (80.3)	2040 (80.3)	2040 (80.3)	2040 (80.3)	2040 (80.3)
Body side height	400 (15.7)	400 (15.7)	400 (15.7)	400 (15.7)	400 (15.7)
Loading height (unladen)	1026 (40.4)	1026 (40.4)	1026 (40.4)	1026 (40.4)	1026 (40.4)
Load area sq.m (sq.ft.)	4.9 (52.7)	6.5 (70.0)	4.9 (52.7)	6.3 (67.8)	7.6 (81.8)

MOVANO BOX VAN SPECIFICATIONS

L3 FWD/RWD (20cu.m)

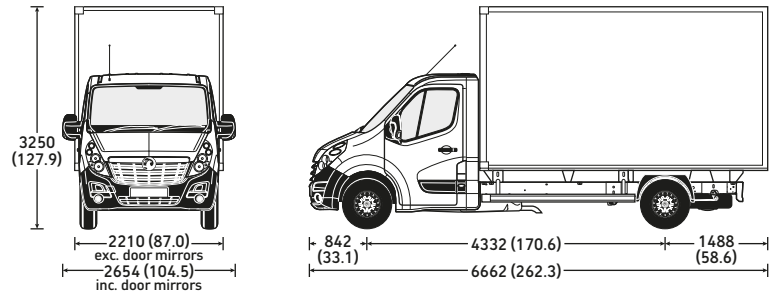

L4 RWD HD (20cu.m)

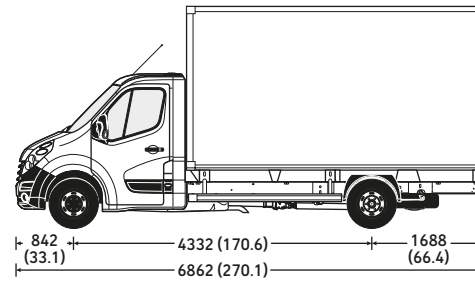

L4 RWD HD (22cu.m)

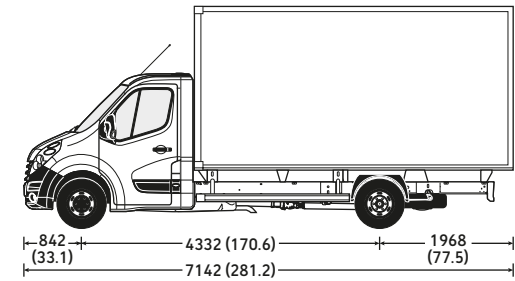

Dimensions mm (inches). Heights shown unladen.

LOADSPACE DIMENSIONS MM (INCHES) – BOX VAN

	L3 20cu.m FWD/RWD	L4 20cu.m RWD	L4 22cu.m RWD
Maximum internal length	4100 (161.4)	4300 (169.3)	4580 (180.3)
Maximum internal width	2150 (84.6)	2150 (84.6)	2150 (84.6)
Maximum internal height	2200 (86.6)	2200 (86.6)	2200 (86.6)
Loading height (unladen)	1050 (41.3)	1050 (41.3)	1050 (41.3)

LOADSPACE VOLUME CU.M (CU.FT.) – BOX VAN

VDA method	19.4 (685.1)	20.3 (716.9)	21.7 (766.3)
------------	--------------	--------------	--------------

MOVANO MINIBUS SPECIFICATIONS

L3 H2 17-SEAT

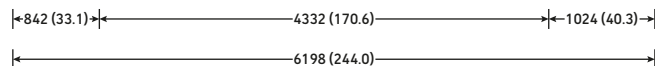
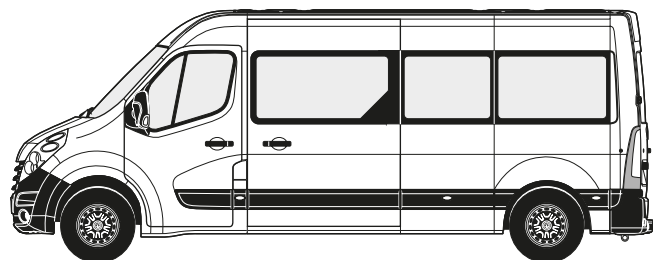

L3 H2 17-SEAT

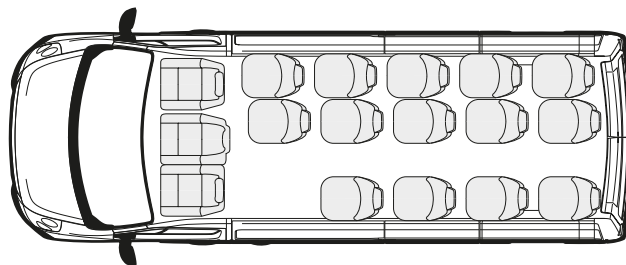

Measurements are shown in millimetres (inches).

PLATED WEIGHTS AND TOWING DATA KG – MINIBUS

Model	Gross Vehicle Weights (GVW)	Plated weights		Towing weights		Plated Gross Combination Weights (GCW)
		Front axle	Rear axle	Braked	Unbraked	
L3 H2 Minibus	F3960	3960	1850	2150	n/a	n/a

Gross plated weights (including axle weights) quoted on the vehicle plate are to UK plated weight specification and must never be exceeded. For further information please see Glossary of Terms.

MOVANO CHASSIS CAB SPECIFICATIONS

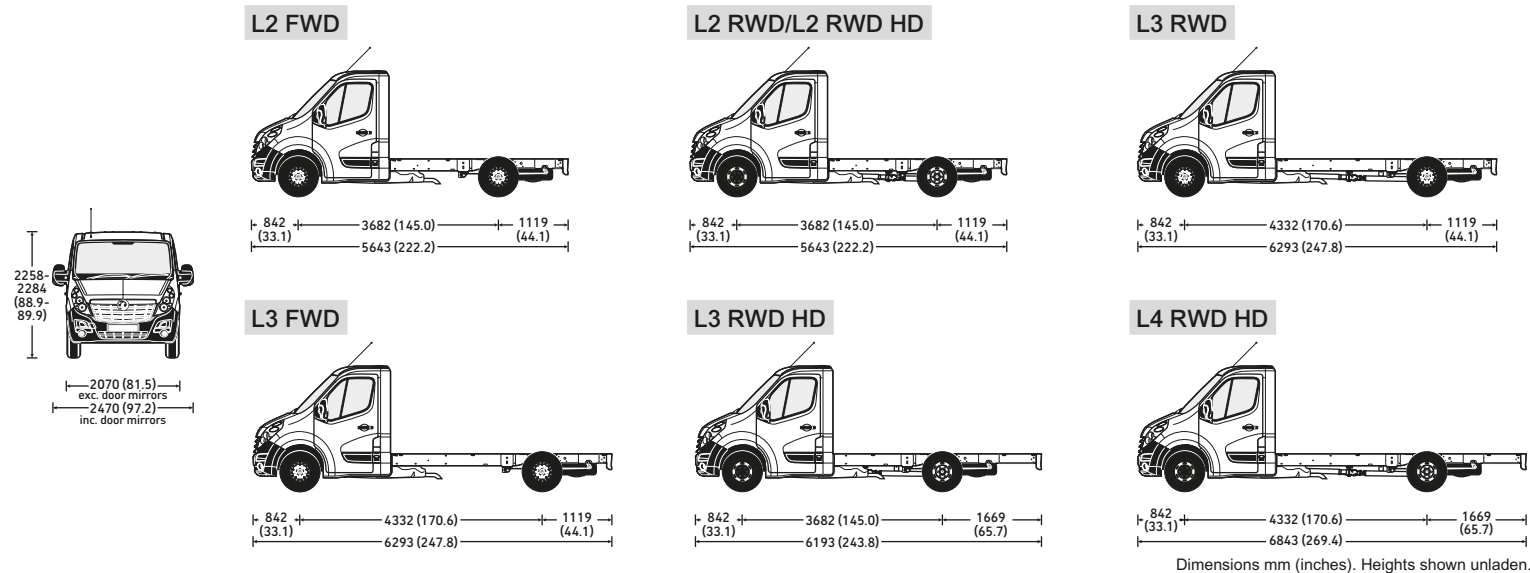

All conversions must follow 'Vauxhall Converter Requirements' including recommended dimensional data, detailed within Part 1, available at: www.vauxhall.co.uk/conversiondata. The weight of any fitted conversion body will have to be deducted from these figures to establish actual payload and is subject to correct weight distribution. Variations from the recommended dimensions or weights may affect the vehicle's overall centre of gravity and stability. From 29 April 2013 conversion of N1 vehicles was affected by changes to type approval – for further information refer to the VCA website (N2 vehicles were affected from 29 October 2014). For further information please contact conversions@vauxhall.co.uk

PLATED WEIGHTS AND TOWING DATA KG – CHASSIS CAB

Model	Gross Vehicle Weights (GVW)	Plated weights		Towing weights		Plated Gross Combination Weights (GCW)	
		Front axle	Rear axle	Braked	Unbraked		
L2 H1/L3 H1/L4 H1	F3500	3500	1850	2100	2500	750	6000
Chassis	R3500	3500	1850	2300	2500	750	6000
	R3500HD	3500	1850	2800	3500	750	7000
	R4500HD	4500	1850	3200	3000	750	7500

Gross plated weights (including axle weights) quoted on the vehicle plate are to UK plated weight specification and must never be exceeded. For further information please see Glossary of Terms.

MOVANO CHASSIS CREW CAB SPECIFICATIONS

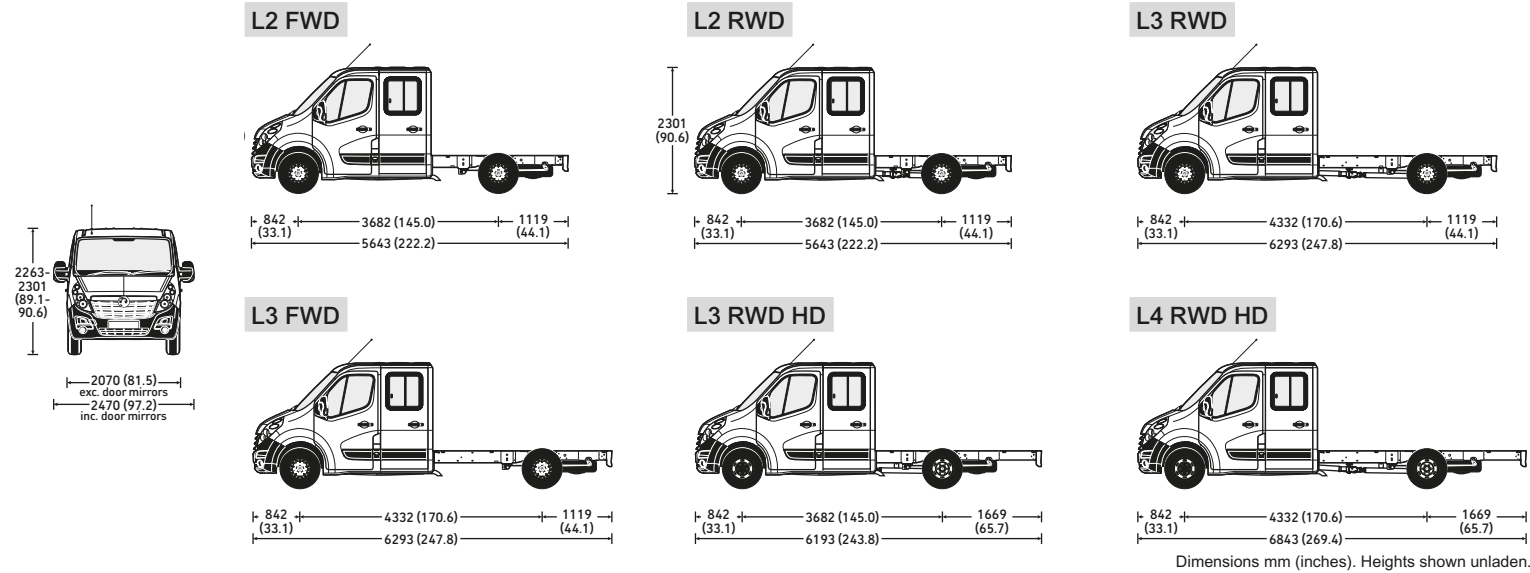

All conversions must follow 'Vauxhall Converter Requirements' including recommended dimensional data, detailed within Part 1, available at: www.vauxhall.co.uk/conversiondata. The weight of any fitted conversion body will have to be deducted from these figures to establish actual payload and is subject to correct weight distribution. Variations from the recommended dimensions or weights may affect the vehicle's overall centre of gravity and stability. From 29 April 2013 conversion of N1 vehicles was affected by changes to type approval – for further information refer to the VCA website (N2 vehicles were affected from 29 October 2014). For further information please contact conversions@vauxhall.co.uk

PLATED WEIGHTS AND TOWING DATA KG – CHASSIS CREW CAB

Model	Gross Vehicle Weights (GVW)	Plated weights		Towing weights		Plated Gross Combination Weights (GCW)	
		Front axle	Rear axle	Braked	Unbraked		
L2 H1/L3 H1/L4 H1	F3500	3500	1850	2100	2500	750	6000
Chassis Crew Cab	R3500	3500	1850	2300	2500	750	6000
	R3500HD	3500	1850	2800	3500	750	7000
	R4500HD	4500	1850	3200	3000	750	7500

Gross plated weights (including axle weights) quoted on the vehicle plate are to UK plated weight specification and must never be exceeded. For further information please see Glossary of Terms.

MOVANO PLATFORM CAB SPECIFICATIONS

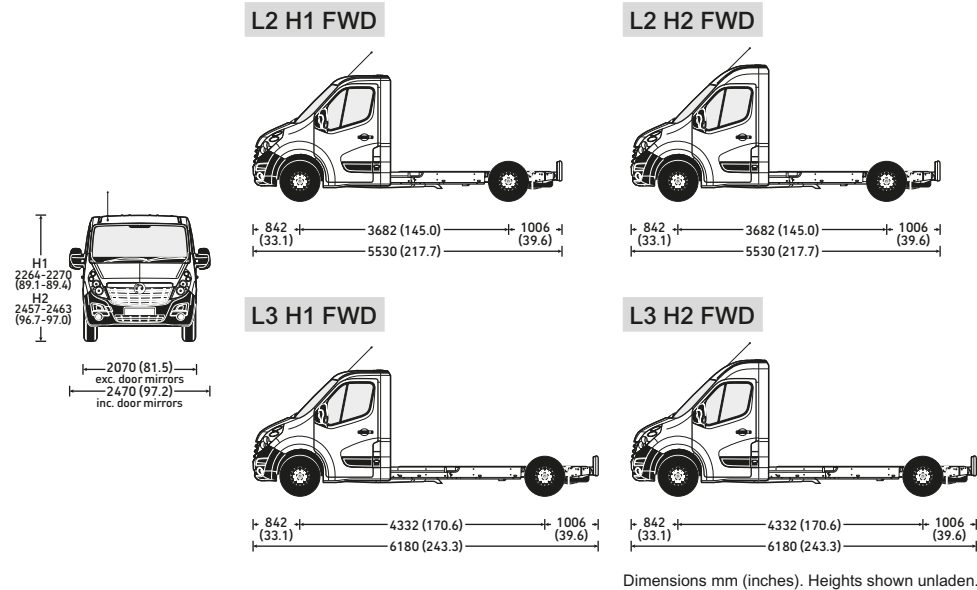

All conversions must follow 'Vauxhall Converter Requirements' including recommended dimensional data, detailed within Part 1, available at: www.vauxhall.co.uk/conversiondata. The weight of any fitted conversion body will have to be deducted from these figures to establish actual payload and is subject to correct weight distribution. Variations from the recommended dimensions or weights may affect the vehicle's overall centre of gravity and stability. From 29 April 2013 conversion of N1 vehicles was affected by changes to type approval – for further information refer to the VCA website (N2 vehicles were affected from 29 October 2014). For further information please contact conversions@vauxhall.co.uk

PLATED WEIGHTS AND TOWING DATA KG – PLATFORM CAB

Model	F3500	Gross Vehicle Weights (GVW)	Plated weights		Towing weights		Plated Gross Combination Weights (GCW)
			Front axle	Rear axle	Braked	Unbraked	
L2 H1/L2 H2/L3 H1/ L3 H2 Platform Cab	F3500	3500	1850	2100	2500	750	6000

Gross plated weights (including axle weights) quoted on the vehicle plate are to UK plated weight specification and must never be exceeded. For further information please see Glossary of Terms.

CORSAVAN ACCESSORIES

INFOTAINMENT

Sat Nav updates¹

Please consult your Retailer for latest map updates or visit www.vauxhall.co.uk/accessories.

1 = For use with optional factory-fit satellite navigation systems.

SAFETY

	Total (exc. VAT)
Safety pack – first aid kit, warning triangle, hi-visibility vest	£30.00
First aid kit	£12.00
Warning triangle	£15.00
Hi-visibility vest	£7.00
Fire extinguisher – 2kg	£31.00
Temporary tyre inflation kit	£125.00
Tyre sealant	£63.00

PRACTICAL

Spare bulb kit	£33.00
Stretch tow rope – 3 tonne	£29.00

SECURITY

Locking wheel bolts – set of four	£43.00
-----------------------------------	--------

PROTECTION – INTERIOR

Rubber floor mats – front pair	£32.00
--------------------------------	--------

PROTECTION – LOAD AREA

Hard cargo liner	£175.00
------------------	---------

PROTECTION – EXTERIOR

Mudflaps – set of four ²	£92.00
Rear parking distance sensors	£265.00

2 = Not available with certain exterior styling accessories.

ROOF CARRIER SYSTEM

T-track base carrier – two roof bars	£121.00
--------------------------------------	---------

Please note:

Prices shown are fully fitted and painted where applicable.

All prices are exclusive of VAT.

It is advisable to ensure your insurance policy is adequate to cover additional fitted accessories.

Prices correct at time of publication.

COMBO ACCESSORIES

	Total (exc. VAT)
SAFETY	
Safety pack – first aid kit, warning triangle, hi-visibility vest	£30.00
First aid kit	£12.00
Warning triangle	£15.00
Hi-visibility vest	£7.00
Fire extinguisher – 2kg	£31.00
Temporary tyre inflation kit	£125.00
PRACTICAL	
Stretch tow rope – 3 tonne	£29.00
SECURITY	
Security alarm system	
– without pre-installation	£370.00
– with pre-installation	£341.00
Steering wheel security bar	£79.00
Locking wheel bolts – set of four	£55.00
Rear window grilles – rear doors, not tailgate	£109.00
PROTECTION – INTERIOR	
Heavy duty carpet mat	£21.00

	Total (exc. VAT)
PROTECTION – LOAD AREA	
Wooden floor protection	
– L1	£168.00
– L2	£201.00
Cargo liner (rigid)	£55.00
PROTECTION – EXTERIOR	
Mudflaps – rear pair only	£67.00
ROOF CARRIER SYSTEM	
Pair of roof bars (70kg) ¹	£182.00
Three roof bars (100kg) ¹	£288.00
Complete roof rack with spoiler and loading system (L1)	£611.00
Complete roof rack with spoiler and loading system (L2)	£666.00
1 = Can only be used in conjunction with optional factory-fitted roof rails.	
TOWING	
Fixed tow bar with 13-pin electrics	£585.45
Flange tow bar with 13-pin electrics	£624.45
Heavy duty tow bar with 13-pin electrics	£675.00
Removable tow bar with 13-pin electrics	£781.00

	Total (exc. VAT)
INTERIOR STYLING	
Sport pedal covers	£109.00
Leather gear knob / gaiter	
– bordeaux / black or grey/black	from £91.00
EXTERIOR STYLING	
Chromed door mirrors	£71.00

Please note:

Prices shown are fully fitted and painted where applicable.

All prices are exclusive of VAT.

It is advisable to ensure your insurance policy is adequate to cover additional fitted accessories.

Prices correct at time of publication.

VIVARO ACCESSORIES

	Total (exc. VAT)
SAFETY	
Safety pack – first aid kit, warning triangle, hi-visibility vest	£30.00
First aid kit	£12.00
Warning triangle	£15.00
Hi-visibility vest	£7.00
Fire extinguisher – 2kg	£31.00
Temporary tyre inflation kit	£125.00

PRACTICAL	
Spare bulb kit	£33.00
Stretch tow rope – 3 tonne	£29.00

SECURITY	
Security alarm system	£307.00
Rear window grilles for rear doors, not tailgate	£193.00

PROTECTION – LOAD AREA	
Plywood floor panel	from £255.00
Plywood side panel	from £277.00

PROTECTION – EXTERIOR	
Mudflaps – set of four	£106.00
Protective wheel arch mouldings	from £91.00

	Total (exc. VAT)
ROOF CARRIER SYSTEM	
Base carrier	
– H1 aluminium	£133.00
– H2 aluminium	£162.00
– H1 steel (black)	£153.00
– H2 steel (black)	£153.00
L1 H1	
– roof rack tray	from £844.00
– walkway	from £219.00
L2 H1	
– roof rack tray	from £737.00
– walkway	from £257.00
L1 H2	
– roof rack tray	from £628.00
– walkway	from £219.00
L2 H2	
– roof rack tray	from £672.00
– walkway	from £252.00

TOWING¹	
Fixed tow bar with 7-pin electrics	£652.80
Fixed heavy-duty tow bar with 7-pin electrics	£699.45
Removable tow bar with 7-pin electrics	£865.00
Fixed tow bar with 13-pin electrics	£682.80
Fixed heavy-duty tow bar with 13-pin electrics	£729.45
Removable tow bar with 13-pin electrics	£895.00

¹ = Prices for standard vehicles only.

Please note:

Prices shown are fully fitted and painted where applicable.

All prices are exclusive of VAT.

It is advisable to ensure your insurance policy is adequate to cover additional fitted accessories.

Prices correct at time of publication.

MOVANO ACCESSORIES

	Total (exc. VAT)
SAFETY	
Safety pack – first aid kit, warning triangle, hi-visibility vest	£30.00
First aid kit	£12.00
Warning triangle	£15.00
Hi-visibility vest	£7.00
PRACTICAL	
Spare bulb kit	£33.00
Stretch tow rope – 3 tonne	£29.00
Smoker Pack	£61.00
SECURITY	
Steering wheel security bar	£79.00
Rear window grilles – H1, H2, H3	£144.00
Side sliding door (right) window grille – L2, L3, L4	£144.00
Side sliding door (left) window grille – L2, L3, L4	£144.00
PROTECTION	
Carpet front floor mat	£54.00
Seat covers – standard (all models)	from £148.00
Seat covers – premium (all models)	£166.00
Mudflaps – set of four – L1/L2	from £106.00
Rear parking distance sensor (4 sensors)	£263.00
Rear-view camera	£303.00

	Total (exc. VAT)
ROOF CARRIER SYSTEM	
Base carrier	
– H1	£287.00
– H2	£289.00
L1 H1	
– Aluminium roof rack including roller	£927.00
– Steel walkway	£322.00
L1 H2	
– Aluminium roof rack including roller	£927.00
– Steel walkway	£322.00
L2 H2	
– Aluminium roof rack including roller	£1040.00
– Steel walkway	£278.00
L3 H2	
– Aluminium roof rack including roller	£1032.00
– Steel walkway	£319.00
L4 H2	
– Aluminium roof rack including roller	£1026.00
– Steel walkway	£316.00
TOWING	
Flange tow bar with 13-pin electrics	from £551.57

Please note:

Prices shown are fully fitted and painted where applicable.

All prices are exclusive of VAT.

It is advisable to ensure your insurance policy is adequate to cover additional fitted accessories.

Prices correct at time of publication.

FOR MORE PRODUCT INFORMATION

For a brochure on any Vauxhall model (up to a maximum of three per caller) or location of your nearest Vauxhall Retailer please call **0345 600 1500**. Alternatively, details can be found on our website at www.vauxhall.co.uk

JOIN US ONLINE:



Privacy Policy – For full details please visit: vauxhall.co.uk/privacy

OnStar privacy details are available at vauxhall.co.uk/onstar

Some feature descriptions in this guide may refer to, and some illustrations may show, optional equipment not included in the standard delivery. The information contained in this guide was accurate at the time of publication. We reserve the right to make changes in design and equipment. The colours in this guide are only approximate actual colours. Illustrated optional equipment is available at extra charge. Availability, technical features and equipment provided on our vehicles can vary by model. For precise information on the equipment provided on our vehicles, please contact your local Vauxhall Retailer.

VAUXHALL

vauxhall.co.uk

©2018 Vauxhall Motors Limited

Published 1 April 2018 (Amended 4 July 2018) Vauxhall Motors Limited