

GRANDLAND X

Infotainment System



VAUXHALL

Contents

Navi 5.0 IntelliLink	5
R 4.0 IntelliLink	57
R 4.0	97



Navi 5.0 IntelliLink

Introduction	6
Basic operation	14
Radio	21
CD Player	26
External devices	27
Navigation	31
Speech recognition	43
Phone	46
Index	54

Introduction

General information	6
Theft-deterrent feature	7
Control elements overview	8
Usage	10

General information

Notice

This manual describes all options and features available for the various Infotainment systems. Certain descriptions, including those for display and menu functions, may not apply to your vehicle due to model variant, country specifications, special equipment or accessories.

Notice

The Infotainment system includes certain third party software. For the associated notices, licenses and any other information regarding this software see <http://www.psa-peugeot-citroen.com/oss>.

Important information on operation and traffic safety

Warning

Drive safely at all times. Only operate the Infotainment system if the traffic conditions allow a safe usage.

In the interest of safety, it might be appropriate to stop the vehicle before operating the Infotainment system (e.g. for entries of addresses).

Warning

The usage of the navigation system does not release the driver from the responsibility for a correct, vigilant attitude in road traffic. Always follow the applicable traffic rules.

Warning

In some areas one-way streets and other roads and entrances (e.g. pedestrian zones) that you are not allowed to turn into are not marked on the map. In such areas the Infotainment system may issue a warning that must be accepted. Here you must pay particular attention to one-way streets, roads and entrances that you are not allowed to drive into.

Radio reception

Radio reception may be disrupted by static, noise, distortion or loss of reception due to:

- changes in distance from the transmitter
- multi-path reception due to reflection
- shadowing

Theft-deterrent feature



The Infotainment system is equipped with an electronic security system for the purpose of theft deterrence.



The Infotainment system therefore functions only in your vehicle and is worthless to a thief.

Control elements overview

Control panel





- 1 Info Display / touchscreen with home menu (home menu only visible after 3-finger touch on screen) 14
- 2 **AUDIO**
- Open audio menu:
- Radio 21
- External devices (USB, Bluetooth) 27
- CD player 26
- 3 **NAV**
- Display embedded navigation map 32
- 4 
- Open phone menu 48
- Display phone projection screen when phone projection is active 30
- 5  10
- If switched off: switch power on / off
- If switched on: mute system
- Turn: adjust volume

- 6 **SET / **
- Open settings menu 14
- or open charging settings (hybrid vehicles), see Owner's Manual
- 7 
- Open apps menu 30
- 8 
- Open vehicle settings menu, see Owner's Manual

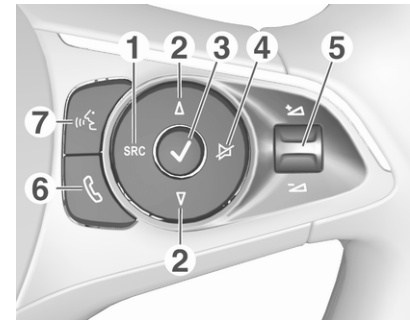
Steering wheel controls



- 1 **SRC (Source)**
- Select audio source, confirm selection with  10
- Long press: mute system
- 2 
- Select next / previous preset radio station when radio active 21
- or select next / previous track / picture when external devices active 27

or select next / previous entry in station list, media list, call / contacts list when operation started via steering wheel controls

Confirm selection with ✓

3 ✓

Confirm selected item

or open station list, media list

4 ✕

Activate / deactivate mute function 10

5 + / -

Turn upwards / downwards: increase / decrease volume

6 ☎

Short press: accept incoming call

Long press: reject incoming call, hang up call 48

or open call / contacts list 48

If phone call active: open call in progress menu

7 

Short press: activate embedded speech recognition

Long press: activate speech recognition in Apple CarPlay™ or Android™ Auto if phone connected via USB port 44

Usage

Control elements

The Infotainment system is operated via function buttons, a touchscreen and menus that are shown on the display.

Inputs are made optionally via:

- the control panel on the Infotainment system ⇨ 8
- the touchscreen ⇨ 14
- the steering wheel controls ⇨ 8
- the speech recognition ⇨ 43

Switching the Infotainment system on or off

Press . After switching on, the last selected Infotainment source becomes active.

Notice

Some functions of the Infotainment system are only available if ignition is switched on or engine is running.

Automatic switch-off

If the Infotainment system has been switched on pressing  while the ignition is switched off, it will switch off again automatically when the Eco mode becomes active.

Setting the volume

Turn . The current setting is shown on the display.

When the Infotainment system is switched on, the last selected volume is set.

Speed compensated volume

When the speed compensated volume is activated , 17, the volume is adapted automatically to make up for the road and wind noise as you drive.

Mute

Press  to mute the Infotainment system.

To cancel the mute function, press  again. The last selected volume is set again.

Modes of operation

Audio-Media

Press **AUDIO** to display the main menu of the last selected audio mode.

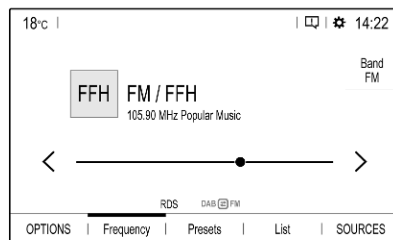

Changing the media source

Select **SOURCES** to display the menu for media source selection.

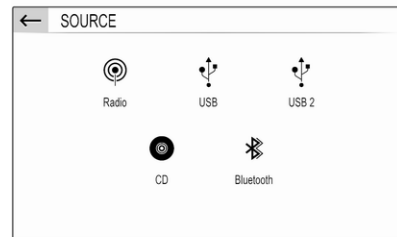

Notice

For a detailed description of menu operation via touchscreen  14.



Select the desired media source.

For a detailed description of:

- Radio functions  21
- CD player  26
- External devices  28

Navigation

Press **NAV** to display the navigation map showing the area around the current location.

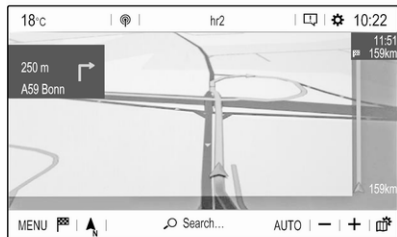

For a detailed description of basic functions of the navigation system ↪ 32.

Navigation menu

Select **MENU** to display the navigation menu.

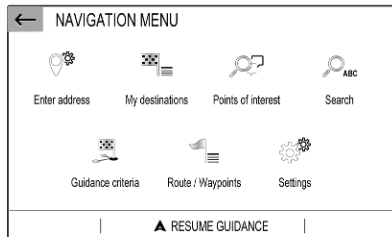

The navigation menu serves as central entry point for:

- Address search and input ↪ 36
- Defining trips with several waypoints ↪ 36
- Defining criteria for route guidance ↪ 40
- Cancelling and resuming route guidance ↪ 40

Phone

Before the phone function can be used, a connection has to be established between the Infotainment system and the mobile phone.

For a detailed description of preparing and establishing a Bluetooth connection between the Infotainment system and a mobile phone ↪ 46.

If the mobile phone is connected, press to display the main menu of the phone function.

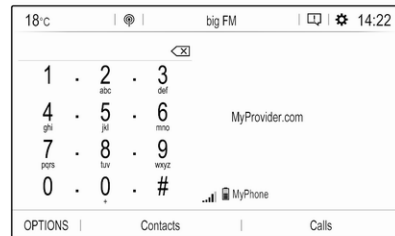



For a detailed description of mobile phone operation via the Infotainment system ↪ 48.

Network and connected services

Press and then select **OPTIONS** to display the Bluetooth, network and connected services settings.

To connect the vehicle to a Wi-Fi network, touch . A list of all available Wi-Fi networks is displayed. It is also possible to share the Wi-Fi connection for other devices.

To update the service and connection status, go to the menu for connected services  and touch .

To use the connected services, make sure that data sharing and the vehicle position are activated in the privacy menu in the **System settings**.

Apps

To show specific apps of your smartphone on the display of the Infotainment system, connect your smartphone.

Press  to display the main menu of the apps mode.

Touch **Apple CarPlay** or **Android Auto**. A menu with different selectable apps is displayed.

For a detailed description ⇨ 30.

Settings

Press **SET** /  and then select **Audio settings** to display the respective menu.

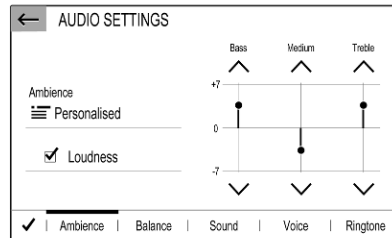

For a detailed description ⇨ 14.

Press **SET** /  and then **OPTIONS** to display a menu for various system-related settings.

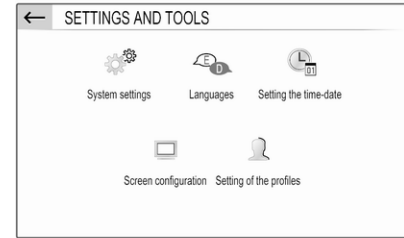

For a detailed description ⇨ 14.

Vehicle settings

Select  to open a menu for various vehicle-related settings.

Vehicle settings are described in the Owner's Manual.

Basic operation

Basic operation 14
 Tone settings 17
 Volume settings 17
 System settings 18

Basic operation

The display of the Infotainment system has a touch-sensitive surface that allows direct interaction with the displayed menu controls.

Caution

Do not use pointed or hard items like ballpoint pens, pencils or similar for touchscreen operation.

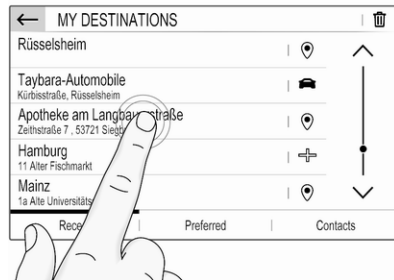

Menu operation

Selecting or activating a screen button or menu item



Touch a screen button or menu item.

Notice

Most icons displayed in a menu, like  or  in the illustrated example, serve as screen buttons that initiate certain actions if you touch them.

The corresponding system function is activated, a message is shown, or a submenu with further options is displayed.

← and ✓ screen buttons

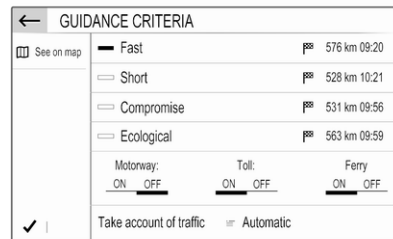

When operating the menus, touch ← in the respective submenu to return to the next higher menu level.

When no ← screen button is displayed, you are on the top level of the respective menu.

After selecting menu items or performing settings in a menu, touch ✓ to confirm your settings. Otherwise all performed selections or settings will be lost.

Shortcuts to important menus

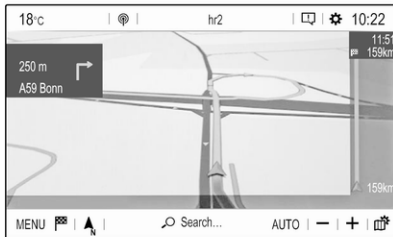

The texts and icons displayed in the top bar, of e.g. the navigation main menu, serve as shortcuts to some important menus. For example, touch the station name to open the station list menu.

Scrolling a list

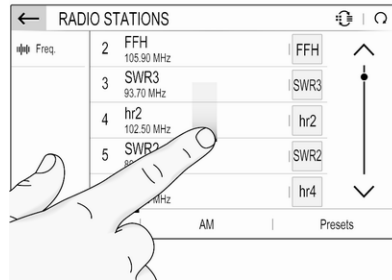

If there are more items available than presentable on the screen, the list must be scrolled.

To scroll through a list of menu items, you may optionally:

- Place your finger anywhere on the screen and move it upwards or downwards.

Notice

Constant pressure must be applied and the finger must be moved at a constant speed.

- Touch ^ or v at the top or bottom of the scroll bar.

- Touch anywhere on the guiding line of the scroll bar.
- Move the slider of the scroll bar up and down with your finger.

Updating a list

Touch ↻ to manually update, e.g., station lists, contacts lists or destination lists.

Input fields and keyboards

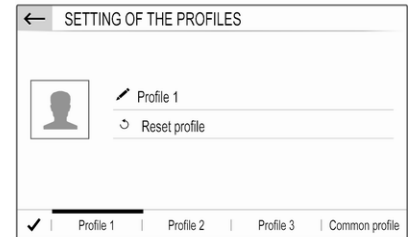

Input fields are indicated by ✎.

Touch the input field to open a keyboard for text or number input.

16 Basic operation

Depending on the application or function currently active, different keyboards are displayed.

Keyboards for text input

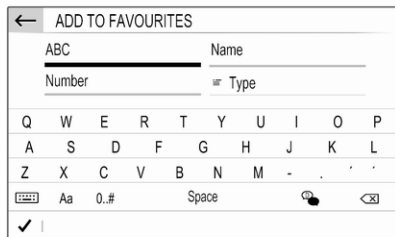

Keyboards for text input may contain several input fields. To enable a field for text input, touch it.

To enter a character, touch the respective screen button. The character is entered upon release.

Touch and hold a letter screen button to display associated letters in a letter pop-up menu. Release and then select the desired letter.

To switch to the symbol keyboard, touch **0.#**.

To switch back to the letter keyboard or to switch between capital and small letters, touch **Aa**.

To switch the letter keyboard between normal order and alphabetical order, touch .

To delete the most recently entered character or symbol, touch .

To delete a character or symbol at any point of your input: touch at the desired point to place a blinking cursor, then touch .

Keyboards for number input

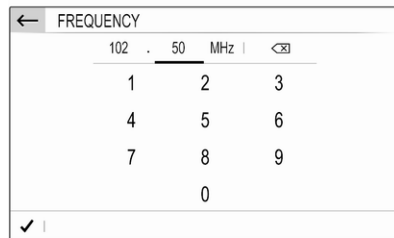

Keyboards for number input may contain several input fields. In the illustrated example, you first need to touch the input field behind the decimal point, before you can enter the decimal digits.

Adjusting a setting

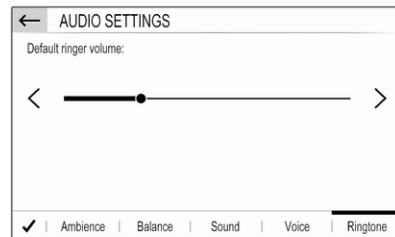

To adjust a setting like the illustrated example, you may optionally:

- Touch < or >.
- Touch anywhere on the line.
- Move the slider with your finger.

Tone settings

Press **SET** / , select **Audio settings** and then select the **Ambience** tab.

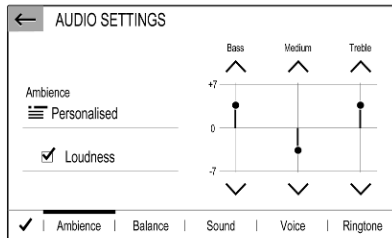

Several predefined settings are available to optimise the tone for a specific style of music (e.g. **Pop-Rock** or **Classical**).

To adjust the tone individually, select **User** or **Personalised**. Change the settings as desired and then confirm your settings.

Notice

If you change the settings of a predefined setting, e.g. **Pop-Rock**, this settings will be applied to the **User** or **Personalised** setting.

Activating the **Loudness** function may optimise the tone at low volume levels.

Balance and fader

Select the **Balance** tab.

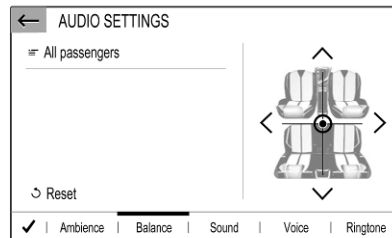

Several predefined settings are available to adjust the volume distribution inside the vehicle (e.g. **All passengers** or **Front only**).

To change the current setting, e.g. **All passengers**, select that setting and then select the desired new setting from the displayed list.

You may individually adjust the predefined settings.

To define the point in the passenger compartment where the volume is at its highest level, move the cursor in the illustration on the right side of the screen to the desired point.

To return to the default factory settings, select .

Volume settings

Press **SET** / , select **Audio settings** and then select the **Sound** tab.

Audible touch feedback

If the audible touch feedback function is activated, each touch of a screen button or menu item is indicated by a beeping sound.

To adjust the touch beep volume, activate **Touch tones** and then adjust the setting.

Speed compensated volume

Activate or deactivate **Volume linked to speed**.

If activated, the volume of the Infotainment system is adapted automatically to make up for the road and wind noise as you drive.

Speech output

Select the **Voice** tab.

Adjust the volume for all speech outputs of the system, e.g. traffic announcements, navigation messages etc.

Ringtone

Select the **Ringtone** tab.

Adjust the ringtone volume of incoming calls.

System settings

Press **SET** /  and then select **OPTIONS**.

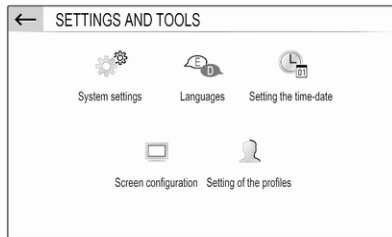

Configuring the system

Select **System settings** to perform some basic system configurations, e.g.:

- Adjust the display of units for temperature or fuel consumption.
- Reset the system configuration to factory defaults.
- Update the installed software version.
- Adjust the privacy settings for data sharing and vehicle position.

Changing display language

To adjust the language for the menu texts, select **Languages** and then select the desired language.

Notice

If the selected display language is supported by the embedded speech recognition, the language of the speech recognition will be changed accordingly; if not, embedded speech recognition will be not available.

Adjusting time and date

Select **Setting the time-date**.

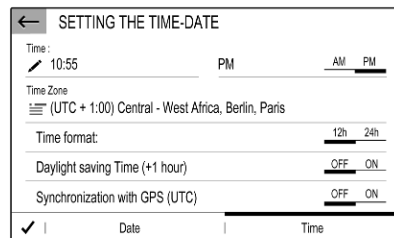

Changing time and date formats

To change the time and date formats, select the respective tabs and then select the desired formats.

Setting time and date

By default the displayed time and date is automatically adjusted by the system.

To manually adjust the displayed time and date:

Select the **Time** tab.

Set **Synchronization with GPS (UTC)** to **OFF** and then select the **Time** field to set the desired time.

Select the **Date** tab and then select the **Date:** field to set the desired date.

Adjusting the screen

Select **Screen configuration**.

Text scroll function

Select the **Animation** tab.

If long texts on the screen should be scrolled automatically, activate

Automatic scrolling.

If **Automatic scrolling** is deactivated, long texts are truncated.

Adjusting the brightness

Select **Brightness** and set the brightness of the screen to the desired level.

Storing your personal settings

Select **Setting of the profiles**.

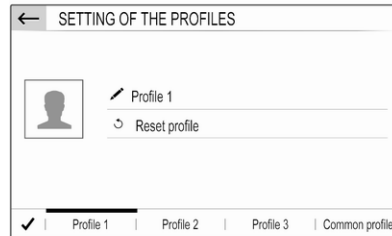

You can store a multitude of settings in a personal profile. For example, all current tone settings, all radio presets, one phone book, the map settings and your preferred addresses.

In case you share the vehicle with other people, this enables you to restore your personal settings from your profile at any time.

A maximum of three personal profiles may be stored.

Additionally, a **Common profile** is available. All settings done at any time are automatically stored in that profile. If no personal profile is activated, the **Common profile** is active.

Storing your personal profile

After performing all your personal settings:

Select one of the personal profile tabs.

Select the input field  and enter the desired name of your personal profile.

If you want to add a photo to the profile:

Connect a USB device with the desired photo stored on it to the USB port  27, touch the photo frame and then select the desired photo.

Confirm your selection to download the selected photo to the system.

Finally, confirm your inputs to store them in your personal profile.

Activating your personal profile

Press  and then select the tab with the name of your personal profile.

Activating the Common profile

If a personal profile is currently active:

Press  and then select **Deactivate profile**.

Resetting a personal profile

You can at any time reset a personal profile to restore the default factory settings on that profile.

Select the respective profile and then select **Reset profile**.

Resetting the Common profile

You can at any time reset the **Common profile** to restore the default factory settings on that profile.

Select **Common profile** and then select **Reset the common profile**.

Radio

Usage	21
Radio data system	23
Digital audio broadcasting	23

Usage

Activating the radio

Press **AUDIO**. The audio main menu last selected is displayed.

If the radio main menu is not active, select **SOURCES** and then select **Radio**.

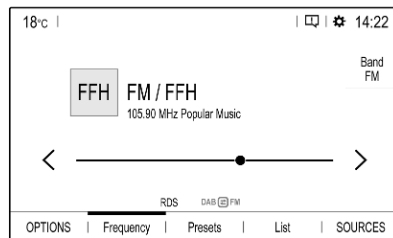

The station last played will be received.

Selecting a waveband

Repeatedly select **Band** to toggle between the different wavebands.

Searching for stations

Automatic station search

Briefly touch < or > to play the previous or next receivable station.

Manual station search

Press and hold < or >. Release when the required frequency has almost been reached.

A search is made for the next station that can be received and it is played automatically.

Station tuning

If you exactly know the reception frequency of a radio station, you may enter that frequency manually.

Select **OPTIONS**, select **Radio stations** and then select the desired waveband.

Select **Freq.**, enter the reception frequency and confirm your input.

If a station is receivable on that frequency, the respective station is played.

Station lists

In the station lists, all receivable radio stations within the current reception area are available for selection.

To display the station list of the waveband currently active, select **List**.

Select the desired station.

Update station lists

If the stations stored in the waveband-specific station list can no longer be received, the AM and the DAB station lists must be updated. The FM station list is updated automatically.

Select **OPTIONS**, select **Radio stations** and then select the desired waveband.

To start an update for the selected waveband, select .

Storing favourite stations

Up to 15 radio stations of all wavebands can be stored as favourites in the **Presets** list.

Select **Presets** to display the preset buttons.

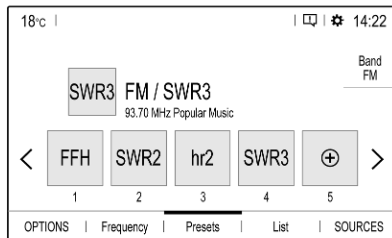

Storing the currently active station



Touch and hold the desired button for a few seconds. The respective frequency or station name is displayed on the button.

If a station is already stored on a preset button, that station will be overwritten by the new one.

Storing a station from a station list

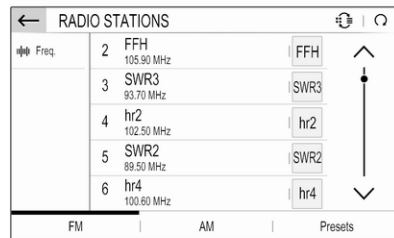
Select **OPTIONS**, select **Radio stations** and then select the desired waveband.



Briefly touch the button next to the desired station. Alternatively, select  to switch to the tiled view. Then briefly touch  on the tile of the desired station.

Select **Add to favourites** and then touch and hold for a few seconds on the list row where you want to store the station.

If a station is already stored on a list row, that station will be overwritten by the new one.

Retrieving stations

In the radio main menu select **Presets** and then briefly touch the preset button of the desired station.

Radio data system

Radio data system (RDS) is a service of FM stations that considerably facilitates the finding of the desired station and its fault-free reception.

Advantages of RDS

- On the display, the programme name of the station appears instead of its frequency.
- During a station search, the Infotainment system tunes in to RDS stations only.
- The Infotainment system always tunes into the best receivable broadcasting frequency of the set station by means of AF (alternative frequency).
- Depending on the station that is received, the Infotainment system displays radio text that can contain e.g. information on the current programme.

RDS configuration

In the radio main menu select **OPTIONS** and then select **Radio settings** to open the menu for RDS configuration.

Activating RDS

Select **General** and then activate **Alternative frequency**.

If **Alternative frequency** is activated, **RDS** is displayed in the bottom line of the radio main menu.

Radio text

If RDS is activated, information on the radio programme currently active or the music track currently playing are displayed below the programme name.

To show or hide the information, activate or deactivate **Display radio text**.

Traffic announcements

Many RDS stations broadcast traffic news. If the traffic announcements function is activated, radio or media playback is interrupted for the duration of a traffic announcement.

Select **Announcements** and then activate or deactivate **Traffic announcement**.

If **Traffic announcement** is activated, **TA** is displayed in the bottom line of the radio main menu.

Digital audio broadcasting

Digital audio broadcasting (DAB) broadcasts radio stations digitally.

DAB stations are indicated by the programme name instead of the broadcasting frequency.

General information

- With DAB, several radio programmes (services) can be broadcast on a single ensemble.
- Besides high-quality digital audio services, DAB is also able to transmit programme-associated data and a multitude of other data services including travel and traffic information.

- As long as a given DAB receiver can pick up the signal sent out by a broadcasting station (even if the signal is very weak), sound reproduction is ensured.
- In the event of poor reception, the volume is reduced automatically to avoid the output of disagreeable noises.

If the DAB signal is too weak to be picked up by the receiver, reception is interrupted completely. This incident can be avoided by activating DAB-FM auto tracking, see below.

- Interference caused by stations that are on nearby frequencies (a phenomenon that is typical of AM and FM reception) does not occur with DAB.
- If the DAB signal is reflected by natural obstacles or buildings, the reception quality of DAB is improved, whereas AM or FM reception is considerably impaired in such cases.
- When DAB reception is enabled, the FM tuner of the Infotainment system remains active in the

background and continually searches for the FM stations with the best reception. If **Traffic announcement** ⇨ 23 is activated, traffic announcements of the FM station with the best reception are issued. Deactivate **Traffic announcement** if DAB reception should not be interrupted by FM traffic announcements.

DAB Announcements

Besides their music programmes, a lot of DAB stations also broadcast announcements of various categories. If you activate some or all categories, the currently received DAB service is interrupted when an announcement of these categories is made.

In the radio main menu select **OPTIONS**, select **Radio settings** and then select **Announcements**.

Activate the desired announcement categories, e.g., **News** or **Weather**. Different announcement categories can be selected at the same time.

FM-DAB Linking

This function enables switching from an FM station to a corresponding DAB station and vice versa.

Switching from FM to DAB occurs as soon as a corresponding DAB station is available. Therefore, it is recommended to store favourite stations as DAB stations to reduce frequent switching.

Switching from DAB to FM occurs if the signal is too weak to be picked up by the receiver.

Activation

Precondition is that **Alternative frequency** is activated before FM-DAB Linking can be activated.

To activate FM-DAB Linking, go to **OPTIONS** ⇨ **Radio settings** ⇨ **General** and select **FM-DAB Follow-up**.

The following symbol will be displayed when FM-DAB Linking is activated:



Deactivation

To deactivate FM-DAB Linking, go to **OPTIONS** ▶ **Radio settings** ▶ **General** and deselect **FM-DAB Follow-up**.

FM-DAB Linking will automatically be deactivated when **Alternative frequency** is deactivated.

CD Player

General information	26
Usage	26

General information

A CD player for the playback of audio CDs and MP3 CDs is located in the glovebox.

Caution

Under no circumstances place DVDs, single-CDs with a diameter of 8 cm or shaped CDs in the audio player.

You must not put any stickers on CDs. These discs can get jammed in the CD drive and ruin the player. Replacement of the device will then be necessary.

Usage

Starting CD playback

Push an audio or MP3 CD with the labelled side facing upwards into the CD slot until it is pulled in.

CD playback starts automatically and the CD main menu is displayed.

If a CD is already inserted, but the CD main menu is not active:

Press **AUDIO**, select **SOURCES** and then select **CD**.

CD playback is started.

Operation

For a detailed description of playback functions for music tracks ↪ 28.

Removing a CD

Press . The CD is pushed out of the CD slot.

If the CD is not removed after ejection, it will be drawn back in after a few seconds.

External devices

General information	27
Playing audio	28
Displaying pictures	29
Using smartphone applications ...	30

General information

One or two USB ports are located in the front centre console. Another USB port may be located in the rear console.

Caution

To protect the system, do not use a USB hub.

Notice

The USB ports must always be kept clean and dry.

USB ports

An MP3 player, USB device, SD card (via USB connector / adapter) or smartphone can be connected to each USB port.

The Infotainment system can play audio files or show picture files contained in USB devices.

When connected to a USB port, various functions of the devices mentioned above can be operated via the controls and menus of the Infotainment system.

Notice

Not all auxiliary devices are supported by the Infotainment system.

Notice

If two USB ports are available in the front centre console: To use the phone projection feature ↗ 30 of the Infotainment system, you need to connect your smartphone to the USB port labelled with .

Connecting / disconnecting a device

Connect one of the devices mentioned above to a USB port. If required, use the appropriate connection cable. The music function starts automatically.

Notice

If a non-readable USB device is connected, a corresponding error message appears and the Infotainment system automatically switches to the previous function.

To disconnect a USB device, select another function and then remove the USB device.

Caution

Avoid disconnecting the device during playback. This may damage the device or the Infotainment system.

Bluetooth audio streaming

Streaming allows you to listen to music from your smartphone.

For a detailed description on how to establish a Bluetooth connection ↪ 47.

If audio playback does not start automatically, it may be necessary to start the playback on the smartphone.

First adjust the volume on your smartphone (to a high level). Then adjust the volume of Infotainment system.

File formats

The audio equipment supports different file formats.

Playing audio

Activating the music function

Connecting the USB or Bluetooth device ↪ 27.

If device already connected, but playback of stored music files not active:

Press **AUDIO**, select **SOURCES** and then select the respective source.

Playback of the audio tracks starts automatically.



Playback functions

Interrupting and resuming playback

Touch **||** to interrupt playback. The screen button changes to **▶**.

Touch **▶** to resume playback.

Playing the previous or next track

Touch **<** or **>**.

Fast forwarding and rewinding

Touch and hold **<** or **>**. Release to return to normal playback mode.

Alternatively, you can move the slider showing the current track position to the left or right.

Playing tracks randomly

Touch button repeatedly to toggle between the available random modes.

ON : play tracks of currently selected list (album, artist, etc.) in random order.

ALL : play all tracks stored on connected device in random order.

: play tracks of currently selected list (album, artist, etc.) in normal playback mode.

Repeating tracks

Touch button repeatedly to switch repeat mode on or off.

: repeat tracks of currently selected list (album, artist, etc.).

: play tracks of currently selected list (album, artist, etc.) in normal playback mode.

Browse music functions

(only available for devices connected via USB)

You can have your music files sorted according to different criteria. Two options are available for browsing the music files stored on the connected USB device.

Browsing via main menu

If you want to change the currently active USB source, select **SOURCES** and then select the desired source. The respective main menu is displayed.

Select the button showing the currently selected sorting criteria, e.g. **Sort: Album** or **Sort: Artist**, and then select the desired new sorting criteria. A sorting process is performed.

Select **List** and then select the desired track.

Playback of the selected track is started.

Browsing via device menu

Select **OPTIONS** and then select **Music files**.

If you want to change the currently active USB source, select **Other**.

Select the desired sorting criteria, e.g. **Albums** or **Artists**, and then select the desired track.

Playback of the selected track is started.

Displaying pictures

You can view pictures stored on a USB device.

Activating the picture viewer

Connecting the USB device ↗ 27.

If device already connected, but picture viewer not active:
Press **AUDIO**, select **OPTIONS** and then select **Managing photos**.

Select the desired picture.

A slide show of all stored picture files starts automatically.



Touch the screen to display the menu bar.

Viewing the previous or next picture

Touch **◀◀** or **▶▶**.

Starting or stopping a slide show

Select ► to view the pictures stored on the USB device in a slide show.

Touch II to end the slide show.

Using smartphone applications

Phone projection

The phone projection applications Apple CarPlay and Android Auto display selected apps from your smartphone on the Info Display and allow their operation directly via the Infotainment controls.

Check with the device's manufacturer if this function is compatible with your smartphone and if this application is available in the country you are in.

Preparing the smartphone

iPhone®: Make sure Siri® is activated on your phone.

Android phone: Download the Android Auto app to your phone from the Google Play™ Store.

Connecting the smartphone

iPhone

Connect the phone to the USB port ⇨ 27.

If the phone is already connected via Bluetooth, upon connecting to the USB port and launching Apple CarPlay, the Bluetooth connection will disconnect.

Android phone

Connect the phone via Bluetooth ⇨ 47 and then connect the phone to the USB port ⇨ 27.

Starting phone projection

Press  and then touch

Apple CarPlay or Android Auto.

The phone projection screen displayed depends on your smartphone and software version.

Returning to the Infotainment screen

Press, e.g., the **AUDIO** button on the control panel.

Navigation

General information	31
Usage	32
Destination input	36
Guidance	40

General information

This chapter is about the embedded navigation system which guides to desired destinations.

The current traffic situation is taken into account in the route calculation. For this purpose, the Infotainment system receives traffic announcements in the current reception area via RDS-TMC.

The navigation system cannot, however, take into account traffic incidents, traffic regulations changed at short notice and hazards or problems that arise suddenly (e.g. road works).

Caution

The usage of the navigation system does not release the driver from the responsibility for a correct, vigilant attitude in road traffic. The relevant traffic regulations must always be followed. If a navigation instruction contradicts traffic regulations, the traffic regulations always apply.

Functioning of the navigation system

The position and movement of the vehicle are detected by the navigation system using sensors. The travelled distance is determined by the vehicle's speedometer signal, turning movements on bends by a sensor. The position is determined by the GPS (Global Positioning System) satellites.

By comparing the sensor signals with the digital maps, it is possible to determine the position with an accuracy of approx. 10 m.

The system will also work with poor GPS reception. However, the accuracy of the determination of the position will be reduced.

After the entry of the destination address or point of interest (nearest petrol station, hotel, etc.), the route is calculated from the current location to the destination selected.

Route guidance is provided by voice output and an arrow, as well as with the aid of a multi-colour map display.

Important information

TMC traffic information system and dynamic route guidance

The TMC traffic information system receives all current traffic information from TMC radio stations. This information is included in the calculation of the overall route. During this process, the route is planned so that traffic problems related to pre-selected criteria are avoided.

To be able to use TMC traffic information, the system must receive TMC stations in the relevant region.

Live navigation

When data sharing and the vehicle position are activated, the navigation system will show online traffic information as well as online information for parking, fuel prices and weather. The services can be stopped at anytime by deactivating data sharing and the vehicle position.

Data sharing and the vehicle position can be activated or deactivated via the privacy menu in the **System settings**.

Network and connected services
➤ 10.

The privacy menu and the menu for connected services are also accessible via the message icon on the screen.

Map data

All required map data is stored within the Infotainment system.

Map updates are available at a Vauxhall Service Partner or at the MyVauxhall customer portal. To download the map updates from the Vauxhall customer portal, a MyVauxhall account and a USB stick with at least 16 GB memory and FAT 32 / MBR formatting are necessary.

Download and save the map data on a computer and unpack the data onto the USB stick.

To update the map data in the Infotainment system, connect the USB stick to the Infotainment system, select the navigation function and follow the steps on the Info Display.

The installation of the map update will take up to 1 hour. Do not switch off the engine during the installation process.

Some functions of the Infotainment system, e.g. the navigation function, are not available during the installation process.

Usage

Information on the map display

Press **NAV** to display the navigation map showing the area around the current location.

Route guidance not active

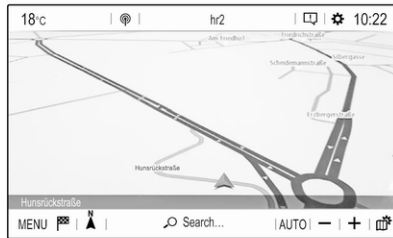

- The map view is displayed.
- The current location is indicated by an arrow.
- The name of the street you are currently in is displayed at the bottom left of the map view.
- Public charging stations are indicated (electric vehicles).

Route guidance active

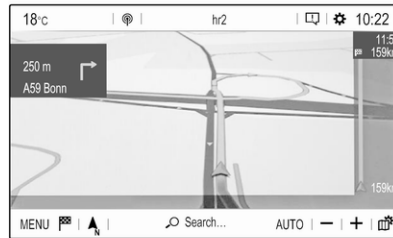

- The map view is displayed.
- The active route is indicated by a coloured line.
- The moving vehicle is marked by an arrow pointing into the direction of travel.
- The next turning manoeuvre is shown in a separate field at the top left of the map view.
Depending on the situation information on lane guidance or the second next turning

manoeuvre may be displayed additionally.

- The arrival time and the remaining distance to the destination is shown at the top right of the map view.

Customise the map display

Map views

Different map views are available.

Touch  to toggle between the different map views.

Depending on the map view, the remaining range is displayed as a circle (electric vehicles).

Map colours

Depending on the external lighting conditions, the colouring of the map screen (light colours for the day and dark colours for the night) can be adapted.

Touch  to display a menu on the right side of the screen.



Select **Map colour** repeatedly to toggle between light and dark colours.

POI (Points of Interest) icons on the map

POIs are points of general interest, e.g. petrol stations or car parks.

The display of POI categories shown on the map may be personally adapted.

Activate the desired POI categories. The map view changes accordingly.

Alternatively, select **POI on map** to display a menu with a multitude of POI categories and subcategories to choose from. Activate the desired POI categories.

Traffic events

Traffic events may be indicated on the map. Additionally, information on these events may be displayed in a list.

Select **Consult map** to switch to an alternative map display with new menu options.

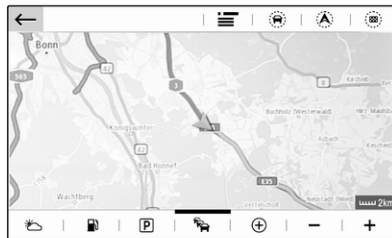

The map view is switched to **North orientation** mode and may display a greater part of the route.

Touch the traffic jam icon to show traffic events on the map. Touch  to show a list with information on these traffic events.

Touch the charging station icon to display a circle that indicates the remaining range (electric vehicles).

If you want to display a different map section:

Touch  to show the area around the current location.

Touch  to show the entire route.

Touch  to show the area around the destination.

To return to the default navigation view, touch .

Autozoom function



If the autozoom function is activated (**AUTO** is displayed below the map view), the zoom level changes automatically when approaching a turning manoeuvre during active route guidance. This way, you always get a good overview of the respective manoeuvre.

If the autozoom function is deactivated, the selected zoom level remains the same during the whole route guidance process.

To activate or deactivate the function: Select **MENU**, select **Settings** and then select the **Aspect** tab.

Activate or deactivate **Automatic zoom setting**.

Map manipulation

Moving visible map section

Place your finger anywhere on the screen and move it in the desired direction.

The map moves accordingly, displaying a new section. A new button bar is shown.

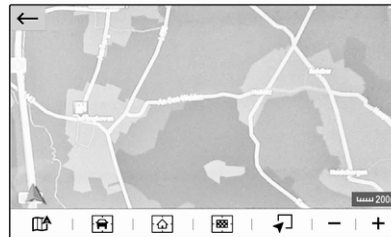

: show area around current location again.

: show area around home address.

: show area around destination.

To return to the default navigation view, select .

Centring visible map section

Touch the desired location on the screen to centre the map around this location.

A red  is displayed at the respective location and the corresponding address is shown on a label.

Manual zooming

To zoom in on a selected map location, place two fingers on the screen and move them away from each other.

Alternatively, touch  below the map view.

To zoom out and display a larger area around the selected location, place two fingers on the screen and move them towards each other.

Alternatively, touch  below the map view.

Showing an overview of the route

Touch , select **Consult map** and then touch .

The map view is switched to **North orientation** and shows an overview of the current route.

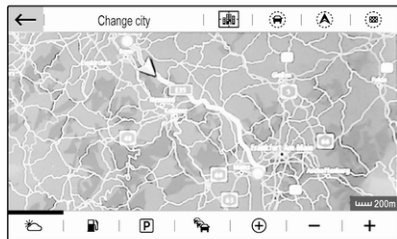

To return to the default navigation view, touch .

Voice guidance

The route guidance process can be supported by voice prompts given out by the system.

To activate or deactivate the function:

Select **MENU** in the navigation main menu, select **Settings** and then select the **Vocal** tab.

Activate or deactivate **Activate navigation messages**.

Navigation settings

Select **MENU** in the navigation main menu, and then select **Settings** to display the respective menu with a variety of navigation related settings.

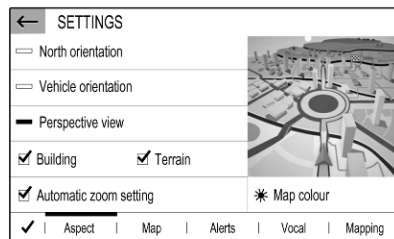

Please explore the different settings. Some have already been described above, others are described in the following sections.

Destination input

The navigation system provides various options to set a destination for route guidance.

Press **NAV** to display the navigation main menu.

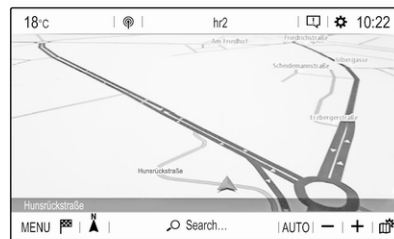

Selecting an address from the map

Touch the desired location on the map. The map centres around this location.

A red  is displayed at the respective location and the corresponding address is shown on a label.

To start route guidance, select **A**.
For a detailed description on route guidance ⇨ 40.

Quick address or POI search

Select **Search....** A menu with a list of recent destinations and a keyboard is displayed.

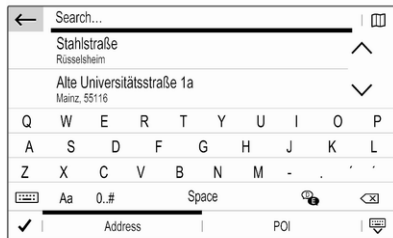

To refine the area for your address or POI search, select **☐** and then select the desired option.

To hide the keyboard and show the entire list, select **☑**. To show the keyboard again, select **☐**.

If you want to search for POIs (Points of Interest) only, select the **POI** tab.

Enter an address or search term. As soon as characters are entered an address search is performed and the list of found addresses is updated continuously.

Select the desired list item.

Depending on the current situation and your selection, the navigation system may react differently:

- If the selected list item is a valid destination address and route guidance is currently not active:

The navigation main menu is displayed again and route guidance is started.

For a detailed description on route guidance ⇨ 40.

- If the selected list item is a valid destination address but route guidance is already active:

A message is displayed and you need to decide first if the old destination should be replaced, or if you want to add the selected address as an intermediate destination to a waypoint trip.

Detailed description on waypoint trips, see below.

Select the desired option.

- If the navigation system needs more detailed information for route calculation:

Enter a further search term to refine your search.

Detailed address entry

Select **MENU** and then select **Enter address** to display a keyboard for address entry.



As soon as characters are entered, an address search is started. Every additional character is considered in the matching process and a list of matching addresses is displayed.

Select the desired address or change your input to initiate a new search.

Continue with the address entry until the entire address you are searching for is found.

Notice

Make sure that the correct country is selected. To change the country, touch the country code in the upper right corner.

To start route guidance to the respective address, confirm your input.

For a detailed description on route guidance ↪ 40.

Storing your favourite addresses

If you want to store the entered address, select .

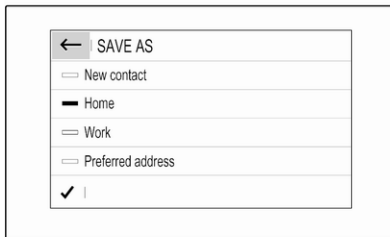

You may store the address as, e.g., your **Home** address or your **Work** address.

Select the desired option, confirm your selection and then enter a name for the address.

The stored address can then be easily selected as destination address via the destination lists **Preferred** or **Contacts**, see below.

Destination lists

Select **MENU** and then select **My destinations**.



Select **Recent** to display a list of all recently entered destinations.

Select **Preferred** to display all destinations which were stored before as home address, work address or preferred address.

Select **Contacts** to display a list with contact names and all related addresses stored before as personal contacts.

To start route guidance to the respective address, select a list entry.

For a detailed description on route guidance ↪ 40.

Points of interest

A point of interest (POI) is a specific location that might be of general interest, e.g. a petrol station, a parking area or a restaurant.

The data stored within the navigation system contains a great number of predefined POIs, which are indicated on the map (if activated, ⇨ 32).

Selecting a POI from the map

Touch the desired POI icon on the map. The map centres around this location.

Touch the icon again.

A red 📍 is displayed at the respective location and the corresponding address is shown on a label.

To start route guidance, select ▲.

For a detailed description on route guidance ⇨ 40.

Showing a list of POIs around a location

Touch the desired location on the map. The map centres around this location.

A red 📍 is displayed at the respective location and the corresponding address is shown on a label.

Touch and hold 📍.

A list of POIs around the location is displayed.

Select the desired POI to start route guidance.

For a detailed description on route guidance ⇨ 40.

Searching for POIs via categories

Select **MENU** and then select **Points of interest**.

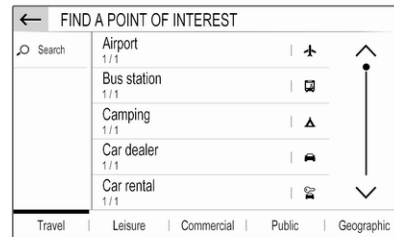

Select a POI main category, e.g., **Travel** and then select a subcategory, e.g. **Airport**. A new menu is displayed.

Select a search area, e.g., **Around the vehicle** to refine the search.

After the POI search is performed, select the desired POI.

To search for POIs at another location, select **Address**.

To search for POIs via keyword (see below), select **Search**.

Searching via keyword

Select **MENU**, select **Search**, enter a keyword, e.g., "Station", enter or select a city name and confirm your input.

After the POI search is performed, select the desired POI.

Waypoint trips

A waypoint is an intermediate destination that is considered in the calculation of a route to its final destination. To create a waypoint trip, you may add one or several waypoints.

Enter or select the final destination of your waypoint trip and start route guidance.

While under active route guidance, select **MENU** and then select **Route / Waypoints**.

ROUTE AND WAYPOINTS		↓↑
Add waypoint	BNJ Bonn-Hangelar 128 Richthofenstraße, Hangelar	1
Overview	CGN Köln Bonn Airport: Terminal 2 Kennedystraße, Grengel	2
Finish	Rüsselsheim Stahlstraße	PSB
Waypoints		Route

Select **Add waypoint** and then select an option for address entry, e.g. **Find POI**.

Enter or select a new address. The address is inserted into the list of waypoints.

If desired, enter further waypoints as described above.

If you want to change the order of the waypoints:

Touch ↓↑ and then touch the displayed arrows to move the list entries up or down.

Select **Calculate** to recalculate the route according to the changed order.

To return to the navigation main menu, select **Finish**.

To display a detailed route list of the waypoint trip, select the **Route** tab.

ROUTE AND WAYPOINTS			
Add waypoint	60 Alexanderstraße m Turn right	↗	↑ ↓
Overview	400 B1/B5 Alexanderstraße m Turn right	↗	
Finish	8 Wexstraße, Tegel km Turn right	↗	
	8 A100, Magdeburg km Bear left	↙	
	9 A100 km	↑	↓
Waypoints		Route	

Guidance

Route guidance is provided by the navigation system through visual instructions and voice prompts (voice guidance).

Visual instructions

Visual instructions are provided on the display.

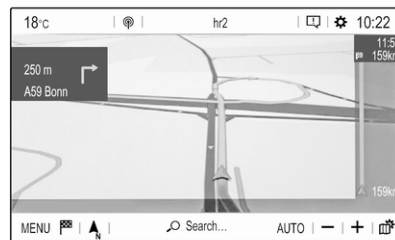

Notice

When route guidance is active and you are not within the navigation application, turning manoeuvres are shown on the instrument cluster display.

Voice guidance

Navigation voice prompts announce which direction to follow, when approaching an intersection at which you need to turn.

To activate or deactivate the voice prompts function select **MENU** in the navigation main menu, select **Settings**, select the **Vocal** tab and then activate or deactivate **Activate navigation messages**.

If voice prompts are activated you can additionally specify whether street names should be spoken or not.

To replay the last voice guidance instruction, touch the turn arrow on the left side of the screen.

Settings for route guidance

Select **MENU** in the navigation main menu and then select **Guidance criteria** to display the respective menu.

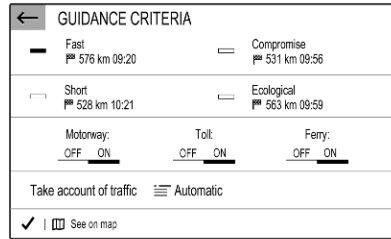

When the menu is opened, several optional routes are automatically calculated by the navigation system, e.g. the fastest route or the most ecological route.

To show the different optional routes on a map, select **See on map**.

If you want, e.g., avoid motorways on your route, set the respective option to **OFF**.

Take account of traffic

Traffic events are taken into consideration when the system determines a route to a destination.

During active route guidance, the route can be modified according to incoming traffic messages.

Three options are available for **Take account of traffic**:

If you want the system to automatically modify the route according to new traffic messages, select **Automatic**.

If you want to be consulted when a route is modified, select **Manual**.

If you do not want routes to be modified, select **None**.

Starting, cancelling, resuming route guidance

To start route guidance, enter or select a destination address ↻ 36. Depending on the situation, route guidance may start automatically, or you may have to follow some instructions on the screen.

To cancel route guidance, select **MENU** in the navigation main menu and then select **STOP NAVIGATION**.

Speech recognition

General information	43
Usage	44

General information

Embedded speech recognition

The embedded speech recognition of the Infotainment system enables you to operate various functions of the Infotainment system via voice input. It recognises commands and numeric sequences independently of the relevant speaker. The commands and numeric sequences can be spoken without a voice pause between the individual words.

In the event of incorrect operation or commands, the speech recognition gives visual and / or acoustic feedback and requests you to re-enter the desired command. Apart from this, the speech recognition acknowledges important commands and will enquire if necessary.

In general, there are different ways to speak commands for performing the desired actions.

Notice

To ensure that conversations inside the vehicle do not lead to unintentional triggering of the

system functions, the speech recognition does not start until it has been activated.

Important information

Language support

- Not all languages available for the display of the Infotainment system are also available for the speech recognition.
- If the display language currently selected is not supported by the speech recognition, speech recognition is not available.

In such a case, you need to select another language for the display if you want to control the Infotainment system via voice input. To change the display language ↻ 18.

Address input of destinations in foreign countries

In case you want to enter the address of a destination located in a foreign country via voice input, you need to change the language of the Info Display to the language of the foreign country.

E.g., if the display is currently set to English and you want to enter the name of a city located in France, you need to change the display language to French.

For changing the display language, see "Language" in chapter "System settings" ⇨ 18.

Input order for destination addresses

The order in which the parts of an address need to be entered using the speech recognition system is dependent on the country where the destination is located.

If the speech recognition system rejects your address entry, repeat the command with a different order of the address parts.

Voice pass-thru application

The voice pass-thru application of the Infotainment system allows access to the speech recognition commands on your smartphone.

Voice pass-through is available via the phone projection applications Apple CarPlay and Android Auto ⇨ 30.

Usage

Embedded speech recognition

Activating speech recognition

Notice

Speech recognition is not available during an active phone call.

Activation via the button on the steering wheel



Press  on the steering wheel.

The audio system mutes, a voice output message prompts you to say a command, and help menus with the most important commands currently available are shown on the display.

The speech recognition is ready for voice input, after a beep has been given.

You can now say a voice command to initiate a system function (e.g. playing a preset radio station).

Adjusting the volume of voice prompts

Press volume button on the steering wheel upwards (increase volume)  or downwards (decrease volume) .

Interrupting a voice prompt

As an experienced user, you can interrupt a voice prompt by briefly pressing  on the steering wheel.

Alternatively you can say "Set dialogue mode as expert".

A beep is heard immediately, and a command can be stated without having to wait.

Cancelling a dialogue sequence

To cancel a dialogue sequence and to deactivate the speech recognition, press  on the steering wheel.

If you do not say any command for a certain period of time, or if you say commands that are not recognised by the system, a dialogue sequence is automatically cancelled.

Operation via speech commands

Follow the instructions given by voice output and shown on the display.

For best results:



- Listen for the voice prompt and wait for the beep before saying a command or replying.
- Read the example commands on the display.
- The voice prompt can be interrupted by pressing  again.
- Wait for the beep and then speak the command naturally, not too fast, not too slow.

Usually commands can be spoken in a single command.

Voice pass-thru application**Activating speech recognition**

Press and hold  on the steering wheel until a speech recognition session is started.

Adjusting the volume of voice prompts

Turn  on the control panel or press volume button on the steering wheel upwards (increase volume)  or downwards (decrease volume) .

Deactivating speech recognition

Press  on the steering wheel. The speech recognition session is ended.

Phone

General information	46
Bluetooth connection	47
Operation	48
Mobile phones and CB radio equipment	51

General information

The phone function provides you with the possibility of having mobile phone conversations via a vehicle microphone and the vehicle loudspeakers as well as operating the most important mobile phone functions via the Infotainment system in the vehicle. To be able to use the phone function, the mobile phone must be connected to the Infotainment system via Bluetooth.

Not all phone functions are supported by every mobile phone. The usable phone functions depend on the relevant mobile phone and network provider. You can find further information on this in the operating instructions for your mobile phone, or you can enquire about them with your network provider.

Important information for operation and traffic safety

Warning

Mobile phones have effects on your environment. For this reason safety regulations and directions have been prepared. You should be familiar with the related directions before you use the telephone function.

Warning

Use of the hands-free facility while driving can be dangerous because your concentration is reduced when telephoning. Park your vehicle before you use the hands-free facility. Follow the stipulations of the country in which you find yourself at present.

Do not forget to follow the special regulations that apply in specific areas and always switch off the mobile phone if the use of mobile phones is prohibited, if

interference is caused by the mobile phone or if dangerous situations can occur.

Bluetooth

The phone function is certified by the Bluetooth Special Interest Group (SIG).

You can find further information about the specification on the internet at <http://www.bluetooth.com>.

Bluetooth connection

Bluetooth is a radio standard for the wireless connection of e.g. mobile phones, smartphones or other devices.



Pairing a device

During the pairing process, PIN code exchange between the Bluetooth device and the Infotainment system and connection of the Bluetooth devices to the Infotainment system are carried out.

Important information

- Two paired Bluetooth devices can be connected to the Infotainment system at the same time. One device in hands-free mode, the other in audio streaming mode, see description on Bluetooth profile settings below.
However, two devices cannot be used in hands-free mode at the same time.
- Pairing only needs to be carried out once, unless the device is deleted from the list of paired devices. If the device has been connected previously, the Infotainment system establishes the connection automatically.
- Bluetooth operation considerably drains the device's battery. Therefore, connect the device to the USB port for charging.

Pairing a new device

1. Activate the Bluetooth function of the Bluetooth device. For further information, see the operating instructions for the Bluetooth device.
2. If another Bluetooth device is already connected:
Press , select **OPTIONS**, select **Bluetooth connection** and then touch  **Search**.
If no Bluetooth device is currently connected:
Press  and then touch **Bluetooth search**.
A search for all Bluetooth devices in the near environment is performed.
3. Select the Bluetooth device you wish to pair from the displayed list.
4. Confirm the pairing procedure:
 - If SSP (secure simple pairing) is supported:

Confirm the messages on the Infotainment system and the Bluetooth device.

- If SSP (secure simple pairing) is not supported:

On the Infotainment system: a message is displayed asking you to enter a PIN code on your Bluetooth device.

On the Bluetooth device: enter the PIN code and confirm your input.

5. Activate the functions you want the paired smartphone to perform and confirm your settings. You can change these Bluetooth profile settings at any time, see below.

The Infotainment system and the device are paired.

6. The phone book is downloaded automatically to the Infotainment system. Depending on the phone, the Infotainment system must be allowed access to the phone book. If required, confirm the

messages displayed on the Bluetooth device.

If this function is not supported by the Bluetooth device, a corresponding message is displayed.

Operations on paired devices

Press , select **OPTIONS** and then select **Bluetooth connection**.

A list of all paired devices is displayed.

Changing the Bluetooth profile settings

Touch  next to the desired paired device.

Activate or deactivate the profile settings as desired and confirm your settings.

Connecting a paired device

Devices which are paired but not connected are identified by .



Select the desired device to connect it.

Disconnecting a device

The currently connected device is identified by .

Select the device to disconnect it.

Deleting a paired device

Touch  in the upper right corner of the screen to display  icons next to each paired device.

Touch  next to the Bluetooth device you want to delete and confirm the displayed message.

Operation

As soon as a connection via Bluetooth has been set up between your mobile phone and the Infotainment system, you can operate many functions of your mobile phone via the Infotainment system.

Notice

In the hands-free mode, mobile phone operation is still possible, e.g. taking a call or adjusting the volume.

After setup of a connection between the mobile phone and the Infotainment system, mobile phone data is transmitted to the Infotainment system. This can take some time depending on the mobile phone and the amount of data to be transferred. During this period, operation of the mobile phone via the Infotainment system is possible only to a limited extent.

Notice

Not every mobile phone fully supports the phone function. Therefore, deviations from the range of functions described below are possible.

Phone main menu

Press  to display the phone main menu.

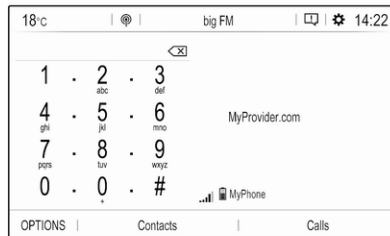

Notice

The phone main menu is only available if a mobile phone is connected to the Infotainment system via Bluetooth. For a detailed description ⇨ 47.

Many functions of the mobile phone can now be controlled via the phone main menu (and associated submenus), and via the phone-specific controls on the steering wheel.

Initiating a phone call

Entering a phone number

Enter a phone number using the keypad in the phone main menu.

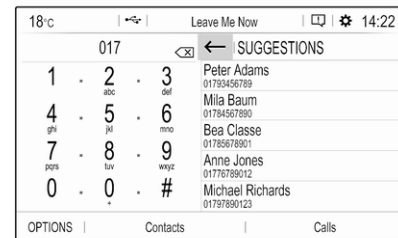

As soon as figures are entered, matching entries from the contacts list are displayed in alphabetical order.

Touch the desired list entry to initiate a phone call.

Using the contacts list

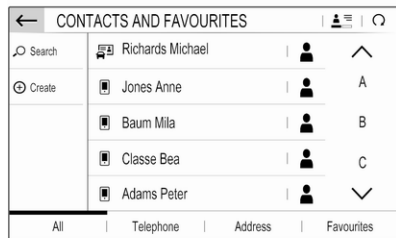

The contacts list contains all phone book entries from the connected Bluetooth device and all contacts from the navigation system.

Select **Contacts** and then select the desired list type.



Searching for a contact

The contacts are ordered by the first name or surname. To change the order, touch .

To scroll through the list, use the scroll bar,  or .

To search for a contact via keyboard, touch **Search**.

Modifying or deleting a contact

Select  next to the contact and then select the desired option.

If you want to add a photo to the contact:

Connect a USB device with the desired photo stored on it to the USB port  27, touch the photo frame and then select the desired photo.

Confirm your selection to download the selected photo to the system.

Using the call history

All incoming, outgoing, or missed calls are registered.

Select **Calls** and then select the desired list.

Select the desired list entry to initiate a call.

Incoming phone call

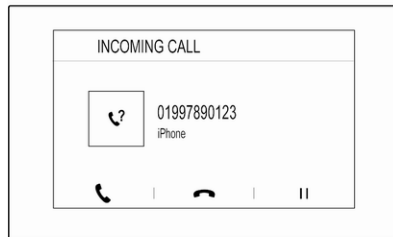

If an audio mode, e.g. the radio or USB mode, is active at the moment a call comes in, the audio source is muted and stays muted until the call ends.

A message with the caller's phone number or name is displayed.



To answer the call, touch .

To reject the call, touch .

To put the call on hold, touch . To resume to the call, touch .

During the ongoing call, the following menu is displayed.



To mute the microphone of the Infotainment system, touch **Micro OFF**.

To continue conversation via the mobile phone (private mode), touch **Private**. To reactivate the conversation via the Infotainment system, touch **Private**.

Notice

If you leave the vehicle and lock it while you are still in a private mode phone conversation, the Infotainment system may remain switched on until you leave the Bluetooth reception area of the Infotainment system.

Put incoming calls always on hold

For safety reasons the phone function can put all incoming calls on hold by default.

To activate this function, select **OPTIONS**, select **Security** and then select **Put incoming calls on hold**.

Quick messages

Different quick messages can be sent to contacts via the Infotainment system.

Select **OPTIONS** and then **Quick messages** to display a list of quick messages sorted by different categories.

To send a quick message, select the respective message and choose the contact.

Mobile phones and CB radio equipment

Installation instructions and operating guidelines

The vehicle specific installation instructions and the operating guidelines of the mobile phone and hands-free manufacturer must be observed when installing and operating a mobile telephone. Failure to do so could invalidate the vehicle type approval (EU directive 95/54/EC).

Recommendations for fault-free operation:

- Professionally installed exterior antenna to obtain the maximum range possible.
- Maximum transmission power 10 W.
- Installation of the phone in a suitable spot, consider relevant Note in the Owner's Manual, section **Airbag system**.

Seek advice on predetermined installation points for the external antenna or equipment holder and ways of using devices with a transmission power exceeding 10 W.

Use of a hands-free attachment without external antenna with mobile telephone standards GSM 900/1800/1900 and UMTS is only permitted if the maximum transmission power of the mobile telephone is 2 W for GSM 900 or 1 W for the other types.

For reasons of safety, do not use the phone while driving. Even use of a hands-free set can be a distraction while driving.

Warning

Operation of radio equipment and mobile telephones which fail to meet above mentioned mobile telephone standards is only permitted using an antenna located outside of the vehicle.

Caution

Mobile telephones and radio equipment may lead to malfunctions in the vehicle electronics when operated inside the vehicle with no exterior antenna, unless the above mentioned regulations are observed.

Index

- A**
- Activating Bluetooth music..... 28
 - Activating CD player..... 26
 - Activating phone..... 48
 - Activating radio..... 21
 - Activating the navigation system. . 32
 - Activating USB audio..... 28
 - Activating USB picture..... 29
 - Address book..... 36
 - Adjust time and date..... 18
 - Audio files..... 27
 - Auto volume..... 17
- B**
- Balance..... 17
 - Basic operation..... 14
 - Bluetooth
 - Bluetooth connection..... 47
 - Bluetooth music menu..... 28
 - Connecting device..... 27
 - General information..... 27
 - Pairing..... 47
 - Phone..... 48
 - Bluetooth connection..... 47
- C**
- Call
 - Functions during a call..... 48
 - Incoming call..... 48
 - Initiating a phone call..... 48
 - Ring tone..... 48
 - Call history..... 48
 - CD player..... 26
 - Change display language..... 18
 - Contacts..... 36, 48
 - Control elements
 - Infotainment system..... 8
 - Steering wheel..... 8
 - Control elements overview..... 8
- D**
- DAB
 - FM-DAB Linking..... 23
 - Date
 - adjust..... 18
 - Destination input 36
 - Digital audio broadcasting..... 23
 - Display
 - adjust brightness..... 18
 - change language..... 18
 - Displaying pictures..... 29
 - Display settings..... 29
- E**
- Equaliser..... 17
- F**
- Factory default settings..... 18
 - Fader..... 17
 - File formats..... 27
 - Audio files..... 27
 - Picture files..... 27

G			
General information	26, 27, 31, 43, 46	TMC stations	31, 40
Bluetooth	27	Traffic incidents	40
DAB	23	Turn list	40
Infotainment system	6	Waypoint trip	36
Navigation	31	O	
Phone	46	Operation	48
Smartphone applications	27	CD	26
USB	27	External devices	27
Guidance	40	Menu	14
I		Navigation system	32
Infotainment control panel	8	Phone	48
M		Radio	21
Maps	32	P	
Menu operation	14	Pairing	47
Mobile phones and CB radio		Personal settings	18
equipment	51	Phone	
Mute	10	Bluetooth	46
N		Bluetooth connection	47
Navigation		Call history	48
Contacts	36	Contacts	48
Current location	32	Entering a number	48
Destination input	36	Functions during a call	48
Map display	32	General information	46
Map manipulation	32	Incoming call	48
Map update	31	Phone book	48
Recent destinations	36	Phone main menu	48
Route guidance	40	Phone book	48
		Phone projection	30
		Picture files	27
		Playing audio	28
		POIs	36
		Presets	
		Retrieving stations	21
		Storing stations	21
		Profile settings	18
		R	
		Radio	
		Activating	21
		Configuring DAB	23
		Configuring RDS	23
		DAB announcements	23
		Digital audio broadcasting (DAB)	23
		Presets	21
		Radio data system (RDS)	23
		Regional	23
		Regionalisation	23
		Retrieving stations	21
		Selecting the waveband	21
		Station search	21
		Station tuning	21
		Storing stations	21
		Usage	21
		Radio data system	23
		RDS	23
		Regional	23
		Regionalisation	23
		Retrieving stations	21

Ring tone.....	48
Ring tone volume.....	17
Route guidance.....	40

S

Smartphone.....	27
Phone projection.....	30
Speech output volume.....	17
Speech recognition.....	43
Storing stations.....	21
Switching the Infotainment system on.....	10
System settings.....	18

T

Theft-deterrent feature	7
Time adjust.....	18
TMC stations.....	31
Tone settings.....	17
Touch beep volume.....	17
Traffic incidents.....	40
Turn list.....	40

U

Update software.....	18
Usage.....	10, 21, 26, 32, 44
Bluetooth.....	27
CD.....	26
Menu.....	14
Navigation system.....	32

Phone.....	48
Radio.....	21
USB.....	27

USB

Connecting device.....	27
General information.....	27
USB audio menu.....	28
USB picture menu.....	29
Using smartphone applications....	30

V

Voice guidance.....	32
Voice recognition.....	43

Volume

Auto volume.....	17
Mute function.....	10
Ring tone volume.....	17
Setting the volume.....	10
Speech output.....	17
Speed compensated volume....	17
Touch beep volume.....	17
Volume settings.....	17

W

Waveband selection.....	21
Waypoint trip.....	36

R 4.0 IntelliLink

Introduction	58
Basic operation	65
Radio	71
External devices	77
Speech recognition	84
Phone	85
Index	94

Introduction

General information	58
Theft-deterrent feature	58
Control elements overview	59
Usage	62

General information

Notice

This manual describes all options and features available for the various Infotainment systems. Certain descriptions, including those for display and menu functions, may not apply to this vehicle due to model variant, country specifications, special equipment or accessories.

Important information on operation and traffic safety

Warning

The Infotainment system must be used so that the vehicle can be driven safely at all times. If in doubt, stop the vehicle and operate the Infotainment system while the vehicle is stationary.

Radio reception

Radio reception may be disrupted by static, noise, distortion or loss of reception due to:

- changes in distance from the transmitter
- multipath reception due to reflection
- shadowing

Theft-deterrent feature





The Infotainment system is equipped with an electronic security system for the purpose of theft deterrence.

The Infotainment system therefore functions only in this vehicle and is worthless to a thief.

Control elements overview

Control panel



- | | | |
|---|--|--|
| <p>1 Info Display / touchscreen 65</p> <p>2 Home menu 65</p> <p>Screen buttons for access to:</p> <p>Audio: audio functions</p> <p>Gallery: picture and movie functions</p> <p>Phone: mobile phone functions</p> <p>Projection: phone projection</p> <p>Settings: system settings</p> <p>3 Time, date and temperature indicators 68</p> <p>4  Short press: open phone menu 88</p> <p>or open phone projection function (if activated) 82</p> <p>Long press: activate speech recognition 84</p> <p>5  Short press: skip to next station when radio active 71</p> | <p>or skip to next track when external devices active 79</p> <p>Long press: seek up when radio active 71</p> <p>or fast forward when external devices active 79</p> <p>6  Short press: switch on Infotainment system if turned off 62</p> <p>or mute system if turned on . 62</p> <p>Long press: switch off Infotainment system 62</p> <p>Turn: adjust volume 62</p> <p>7  Short press: skip to previous station when radio active 71</p> <p>or skip to previous track when external devices active 79</p> | <p>Long press: seek down when radio active 71</p> <p>or fast rewind when external devices active 79</p> <p>8  Short press: display the home screen 62</p> <p>Long press: open phone projection function (if activated) 82</p> |
|---|--|--|

Steering wheel controls

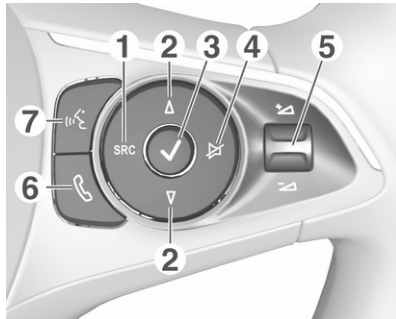

1 SRC (Source)

Select audio source 62

2 Δ / ▽

Select next / previous
preset radio station when
radio active 71

or select next / previous
track / picture when
external devices active 77

or select next / previous
entry in call / contacts list
when phone function
active and call / contact list
open 88

3 ✓

Short press: display the
home screen

Long press: if Apple
CarPlay™ or Android™
Auto activated, show the
respective menu 82

4 📵

Activate / deactivate mute
function 62

5 + / -

Turn upwards /
downwards: increase /
decrease volume

6 📞

Take phone call 88

or open call / contacts list 88
or switch between calls
when calls are waiting 88

7 🗨️

Activate speech recognition .. 84

Usage

Control elements

The Infotainment system is operated via function buttons, a touchscreen and menus that are shown on the display.

Inputs are made optionally via:

- the control panel on the Infotainment system ↷ 59
- the touchscreen ↷ 65
- the steering wheel controls ↷ 59
- the speech recognition ↷ 84

Switching the Infotainment system on or off

Short press  to switch the system on. After switching on, the last selected Infotainment source becomes active.

Notice

Some functions of the Infotainment system are only available if ignition is switched on or engine is running.

Long press  to switch the system off.

Automatic switch-off

If the Infotainment system has been switched on by pressing  while the ignition is switched off, it will automatically switch off again after 10 minutes.

Setting the volume

Turn . The current setting is shown on the display.

When the Infotainment system is switched on, the last selected volume is set, provided that it is lower than the maximum start-up volume. For a detailed description ↷ 67.

Speed compensated volume

When the speed compensated volume is activated ↷ 67, the volume is adapted automatically to make up for the road and wind noise while driving.

Mute

Press  to mute the Infotainment system.

To cancel the mute function, press  again. The last selected volume is set again.

Modes of operation

Press  to display the home screen.

Notice

For a detailed description of menu operation via touchscreen ↷ 65.

Audio

Select **Audio** to open the main menu of the last selected audio mode.

Select **Source** on the screen to display the interaction selector bar.





To change to another audio mode, touch one of the items in the interaction selector bar.

For a detailed description of:

- radio functions ⇨ 71
- external devices ⇨ 79

Gallery

Select **Gallery** to open the picture and movie menu for files stored on an external device, e.g. USB device or smartphone.

Select  or  to display the picture or movie menu. Select the desired picture or movie file to show the respective item on the display.



For a detailed description of:

- picture functions ⇨ 80
- movie functions ⇨ 81

Phone

Before the phone function can be used, a connection has to be established between the Infotainment system and the mobile phone.

For a detailed description of preparing and establishing a Bluetooth connection between the Infotainment system and a mobile phone ⇨ 85.

If the mobile phone is connected, select **Phone** to display the main menu.

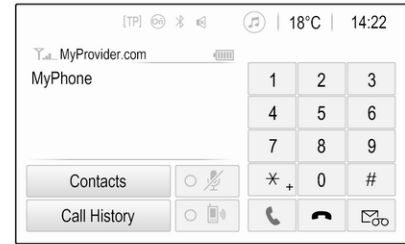

For a detailed description of mobile phone operation via the Infotainment system ⇨ 88.

Projection

To show specific apps of a smartphone displayed on the Infotainment system, connect the smartphone.

Select **Projection** to start the projection function.

Depending on the smartphone connected, a main menu with different selectable apps is displayed.

For a detailed description ⇨ 82.

Settings

Select **Settings** to open a menu for various system-related settings, e.g. deactivating **Audible Touch Feedback**.

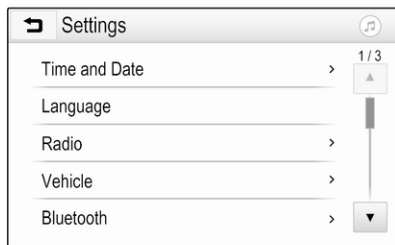

Basic operation

Basic operation	65
Tone settings	66
Volume settings	67
System settings	68

Basic operation

The display of the Infotainment system has a touch-sensitive surface that allows direct interaction with the displayed menu controls.

Caution

Do not use pointed or hard items like ballpoint pens, pencils or similar for touchscreen operation.

↶ screen button

When operating the menus, press ↶ in the respective submenu to return to the next higher menu level. Press 🏠 to display the home screen.

Selecting or activating a screen button or menu item



Touch a screen button or menu item. The corresponding system function is activated, a message is shown, or a submenu with further options is displayed.

Moving items on the home screen

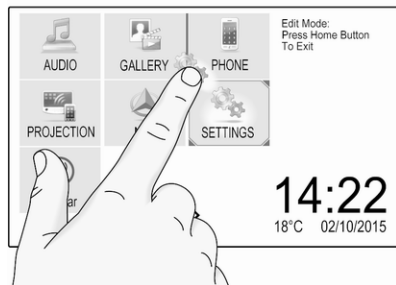

Touch and hold the element until red boxes appear around the icons. Move it to the desired location and release the element.

Notice

Constant pressure must be applied and the finger must be moved at constant speed.

All other items are rearranged.

Press one of the buttons on the control panel to exit edit mode.

Notice

Edit mode exits automatically after 30 seconds of inactivity.

Scrolling lists

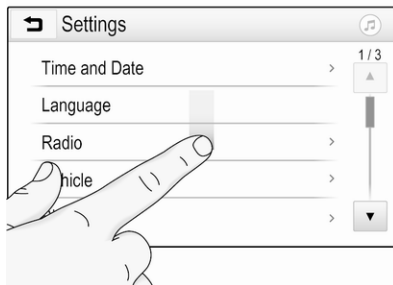

If there are more items available than presentable on the screen, the list must be scrolled.

To scroll through a list, swipe the page or use the arrows.

To return to the top of the list, touch the list title.

Scrolling pages

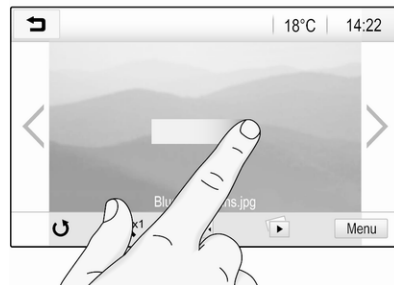

To scroll from one page to another, swipe the page or use the arrows.

Tone settings

In the tone settings menu, the tone characteristics can be set. The menu may be accessed from each audio main menu.

To open the tone settings menu, select **Menu** in the respective audio main menu. If necessary, scroll through the list of menu items and select **Tone Settings**. The respective menu is displayed.

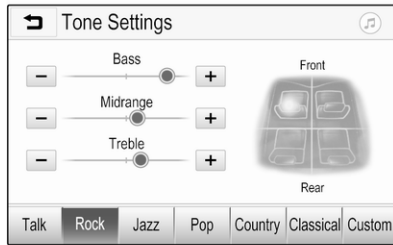

Equaliser mode

Use this setting to optimise the tone for the style of music, e.g. **Rock** or **Classical**.

Select the desired sound style in the interaction selector bar at the bottom of the screen. By choosing **Custom**, the following settings can manually be adjusted.

Bass

Use this setting to enhance or attenuate the deep frequencies of the audio sources.

Touch **+** or **-** to adjust the setting.

Midrange

Use this setting to enhance or attenuate the midrange frequencies of the audio source.

Touch **+** or **-** to adjust the setting.

Treble

Use this setting to enhance or attenuate the high frequencies of the audio sources.

Touch **+** or **-** to adjust the setting.

Setting balance and fader

Use the illustration at the right side of the menu to adjust balance and fader.

To define the point in the passenger compartment where the sound is at its highest level, touch the corresponding point in the illustration. Alternatively, the red marker can be moved to the desired point.

Notice

The balance and fader settings are valid for all audio sources. They cannot be adjusted individually for each audio source.

Volume settings

Adjusting the maximum startup volume

Press **⏠** and then select **Settings**.

Select **Radio**, scroll through the list and then select **Max Startup Volume**.

Touch **+** or **-** to adjust the setting.

Adjusting the speed compensated volume

Press **⏠** and then select **Settings**.

Select **Radio**, scroll through the list and then select **Auto Volume**.

To adjust the degree of volume adaptation, select one of the options in the list.

Off: no enhancement of volume with increasing vehicle speed.

High: maximum enhancement of volume with increasing vehicle speed.

Activating or deactivating the audible touch feedback function

If the audible touch feedback function is activated, each touch of a screen button or menu item is indicated by a beeping sound.

Press  and then select **Settings**.

Select **Radio** and then scroll through the list to **Audible Touch Feedback**.

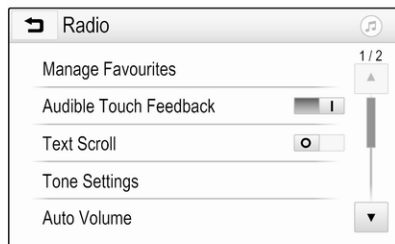

Touch the screen button next to **Audible Touch Feedback** to activate or deactivate the function.

Volume of traffic announcements

To adjust the volume of traffic announcements, set the desired volume while a traffic announcement is given out by the system. The respective setting is then stored by the system.

System settings

The following settings concern the whole system. All other settings are described in the respective chapters of this manual.

Time and date settings

Press  and then select **Settings**.

Select **Time and Date** to display the respective submenu.

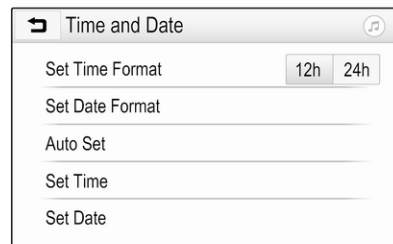

Set Time Format

To select the desired time format, touch the screen buttons **12 h** or **24 h**.

Set Date Format

To select the desired date format, select **Set Date Format** and choose between the available options in the submenu.

Auto Set

To choose whether time and date are to be set automatically or manually, select **Auto Set**.

For time and date to be set automatically, select **On - RDS**.

For time and date to be set manually, select **Off - Manual**. If **Auto Set** is set to **Off - Manual**, the submenu items **Set Time** and **Set Date** become available.

Set time and date

To adjust the time and date settings, select **Set Time** or **Set Date**.

Touch **+** or **-** to adjust the settings.

Language settings

Press **⏠** and then select **Settings**.

Select **Language** to display the respective menu.

To adjust the language for the menu texts, touch the desired language.

Text scroll function

If long text is displayed on the screen e.g. song titles or station names, the text may either be scrolled continually or it may be scrolled once and displayed in truncated form.

Press **⏠** and then select **Settings**.

Select **Radio**.

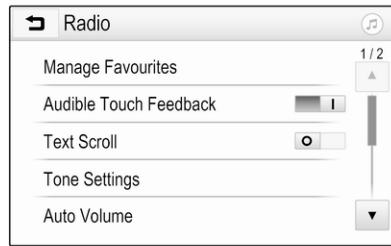

The text will be scrolled continually by activating **Text Scroll**.

Black display function

The display can be turned off.

Press **⏠** and then select **Settings**.

Scroll through the list and select **Turn Display Off**. The display is turned off. The audio functions remain active.

To turn the display on again, touch the screen or press a button.

Factory defaults

Press **⏠** and then select **Settings**.

Scroll through the list and select **Return to Factory Settings**.

To restore all vehicle personalisation settings, select **Restore Vehicle Settings**.

To delete the paired Bluetooth devices, the contacts list and the voice mail numbers stored, select **Clear All Private Data**.

To reset tone and volume settings, delete all favourites, and erase the ringtone selection, select **Restore Radio Settings**.

In each case, a warning message is displayed. Select **Continue** to reset the settings.

System version

Press **⏠** and then select **Settings**.

Scroll through the list and select **Software Information**.

If a USB device is connected, the vehicle information can be saved to this USB device.

Select **System Update** and then **Save Vehicle Info to USB**.

For a system update, contact a workshop.

Vehicle settings

Vehicle settings are described in the Owner's Manual.

Radio

Usage	71
Station search	71
Favourite lists	73
Radio data system	73
Digital audio broadcasting	74

Usage

Activating radio

Press  and then select **Audio**. The audio main menu last selected is displayed.

Select **Source** in the radio main menu to open the interaction selector bar.





Select the desired waveband.

The station last played in the selected waveband will be received.



Station search

Automatic station search



Briefly press  or  to play the previous or next station in the station memory.

Manual station search

Press and hold  or  on the control panel. Release when the required frequency has almost been reached.

A search is made for the next station that can be received and it is played automatically.



Notice

FM waveband: when the RDS function is activated, only RDS stations ⇨ 73 are searched for, and when the radio traffic service (TP) is activated, only traffic service stations ⇨ 73 are searched for.

Station tuning

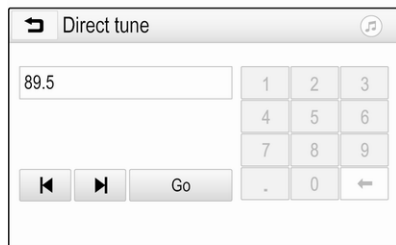
Touch  on the screen. The **Direct tune** screen is shown.



Enter the desired frequency. Use  to delete digits entered. If necessary, touch  or  to subsequently adjust the input.

Confirm the input to play the station.

Station lists

Select **Menu** in the radio main menu to open the corresponding waveband-specific submenu.

Select **Station List**. All receivable stations of the relevant waveband and in the current reception area are displayed.

Select the desired station.

Notice

The currently received radio station is indicated by the  symbol next to the station name.

Category lists

Numerous radio stations broadcast a PTY code, which specifies the type of programme transmitted (e.g. news). Some stations also change the PTY code depending on the content which is currently transmitted.

The Infotainment system stores these stations, sorted by programme type in the corresponding category list.

Notice

The **Categories** list item is not available for the AM waveband.

To search for a programme type determined by the stations, select **Categories**.

A list of programme types currently available is displayed.

Select the desired programme type. A list of stations of the selected programme type is displayed.

Select the desired station.

Notice

The currently received radio station is indicated by the  symbol next to the station name.

Update station lists

If the stations stored in the waveband-specific station list can no longer be received, the station lists must be updated.

Notice

The FM station list is updated automatically.

Select **Menu** in the radio main menu and then select **Update Station List**.

Notice

If a waveband-specific station list is updated, the corresponding category list is also updated.

A station search is started and a corresponding message is displayed. Once the search is finished, the respective station list is displayed.

Notice

The currently received radio station is indicated by the ► symbol next to the station name.

Favourite lists

Stations of all wavebands can be stored manually in the favourite lists.

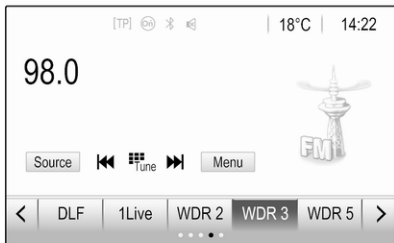

Five favourite lists with five favourites each are available.

Notice

The currently received station is highlighted.

Storing a station

If required, touch < or > to scroll to the desired favourite list.

To store the currently active radio station as a favourite, touch and hold the desired favourite button for a few seconds. The favourite button will be titled as the corresponding frequency or station name.

Retrieving a station

If required, touch < or > to scroll to the desired favourite list.

Select the desired favourite.

Defining the number of available favourite lists

To define the number of favourite lists displayed for selection, press  and then select **Settings** on the screen.

Select **Radio** and then **Manage Favourites** to display the respective submenu.

Activate or deactivate the favourite lists to be displayed.

Radio data system

Radio data system (RDS) is a service of FM stations that considerably facilitates the finding of the desired station and its fault-free reception.

Advantages of RDS

- On the display, the programme name of the station appears instead of its frequency.
- During a station search, the Infotainment system tunes in to RDS stations only.

- The Infotainment system always tunes into the best receivable broadcasting frequency of the set station by means of AF (alternative frequency).
- Depending on the station that is received, the Infotainment system displays radio text that can contain e.g. information on the current programme.

RDS configuration

Touch **Menu** in the FM radio main menu to open the corresponding waveband-specific submenu.

Scroll to **RDS**.

Activate or deactivate **RDS**.

Traffic Programme

Radio traffic service stations are RDS stations that broadcast traffic news. If the traffic service is switched on, the currently playing audio source is interrupted for the duration of the traffic announcement.

Activating the traffic programme function

Select **Menu** in the FM radio main menu to open the corresponding waveband-specific submenu.

Touch the screen button next to **Traffic Programme** to activate or deactivate the function.

Notice

In the station list, TP is displayed next to the stations providing a traffic programme.

If the radio traffic service is activated, **[TP]** is shown in the top line of all main menus. If the current station is not a radio traffic service station, TP is greyed-out and a search is started automatically for the next radio traffic service station. As soon as a radio traffic service station is found, **TP** is highlighted. If no radio traffic service station is found, TP remains greyed-out.

If a traffic announcement is broadcast on the respective station, a message is displayed.

To interrupt the announcement and return to the function previously activated, touch the screen or press .

Regionalisation

Sometimes RDS stations broadcast regionally different programmes on different frequencies.

Select **Menu** in the FM radio main menu to open the corresponding waveband-specific submenu and scroll to **Region**.

Activate or deactivate **Region**.

If regionalisation is activated, alternative frequencies with the same regional programmes are selected where necessary. If regionalisation is switched off, alternative frequencies of the stations are selected without regard to regional programmes.

Digital audio broadcasting

Digital audio broadcasting (DAB) broadcasts radio stations digitally.

DAB stations are indicated by the programme name instead of the broadcasting frequency.

General information

- With DAB, several radio programmes (services) can be broadcast on a single ensemble.
- Besides high-quality digital audio services, DAB is also able to transmit programme-associated data and a multitude of other data services including travel and traffic information.
- As long as a given DAB receiver can pick up the signal sent out by a broadcasting station (even if the signal is very weak), sound reproduction is ensured.
- In the event of poor reception, the volume is reduced automatically to avoid the output of disagreeable noises.

If the DAB signal is too weak to be picked up by the receiver, reception is interrupted completely. This incident can be avoided by activating **DAB-DAB Linking** or **DAB-FM Linking** in the DAB menu (see below).

- Interference caused by stations that are on nearby frequencies (a phenomenon that is typical of AM and FM reception) does not occur with DAB.
- If the DAB signal is reflected by natural obstacles or buildings, the reception quality of DAB is improved, whereas AM or FM reception is considerably impaired in such cases.
- When DAB reception is enabled, the FM tuner of the Infotainment system remains active in the background and continually searches for the FM stations with the best reception. If TP ⇨ 73 is activated, traffic announcements of the FM station with the best reception are issued. Deactivate TP if DAB reception should not be interrupted by FM traffic announcements.

DAB Announcements

Besides their music programmes, a lot of DAB stations also broadcast announcements of various categories. If some or all categories

are activated, the currently received DAB service is interrupted when an announcement of these categories is made.

Select **Menu** in the DAB radio main menu to open the corresponding waveband-specific submenu.

Scroll through the list and select **DAB Announcements** to display a list of the categories available.

Activate all or just the desired announcement categories. Different announcement categories can be selected at the same time.

DAB-DAB Linking

If this function is activated, the device switches over to the same service (programme) on another DAB ensemble (if available) when the DAB signal is too weak to be picked up by the receiver.

Select **Menu** in the DAB radio main menu to open the corresponding waveband-specific submenu.

Scroll through the list and activate or deactivate **DAB-DAB Linking**.

DAB-FM Linking

This function enables switching from a DAB station to a corresponding FM station and vice versa.

If this function is activated, the device switches over to a corresponding FM station of the active DAB service (if available) when the DAB signal is too weak to be picked up by the receiver.

Scroll through the list and activate or deactivate **DAB-FM Linking**.

L Band

This function defines which DAB wavebands are to be received by the Infotainment system.

L Band (earth and satellite radio) is another radio band that can be received additionally.

Select **Menu** in the DAB radio main menu to open the corresponding waveband-specific submenu.

Scroll through the list and activate or deactivate **L Band**.

Intellitext

The **Intellitext** function allows the reception of additional information such as financial information, sports, news etc.

Notice

The content available depends on the station and region.

Select **Menu** in the DAB radio main menu to open the corresponding waveband-specific submenu.

Scroll through the list and select **Intellitext**.

Select one of the categories and choose a specific item to display detailed information.

EPG

The Electronic Programme Guide provides information on the current and upcoming programme of the respective DAB station.

Select **Menu** in the DAB radio main menu and then select **Station List**.

To display the programme of the desired station, touch the icon next to the station.

External devices

General information	77
Playing audio	79
Displaying pictures	80
Playing movies	81
Using smartphone applications ...	82

General information

A USB port for the connection of external devices is located in the centre console.

Notice

The USB port must always be kept clean and dry.

USB port

An MP3 player, USB device, SD card (via USB connector / adapter) or smartphone can be connected to the USB port.

Up to two USB devices can be connected to the Infotainment system at a time.

Notice

For the connection of two USB devices, an external USB hub is required.

The Infotainment system can play audio files, show picture files or play movie files contained in USB devices.

When connected to the USB port, various functions of the devices mentioned above can be operated via the controls and menus of the Infotainment system.

Notice

Not all auxiliary devices are supported by the Infotainment system. Check the compatibility list on our website.

Connecting / disconnecting a device

Connect one of the devices mentioned above to the USB port. If required, use the appropriate connection cable. The music function starts automatically.

Notice

If a non-readable USB device is connected, a corresponding error message appears and the Infotainment system automatically switches to the previous function.

To disconnect the USB device, select another function and then remove the USB device.

Caution

Avoid disconnecting the device during playback. This may damage the device or the Infotainment system.

USB Auto Launch

By default, the USB audio menu is displayed automatically as soon as a USB device is connected.

If desired, this function can be deactivated.

Press  and then select **Settings** to open the settings menu.

Select **Radio**, scroll to **USB Auto Launch** and touch the screen button next to the function.

To reactivate the function, touch the screen button again.

Bluetooth

Devices which support the Bluetooth music profiles A2DP and AVRCP can be connected wirelessly to the Infotainment system. The Infotainment system can play music files contained in these devices.

Connecting a device

For a detailed description on how to establish a Bluetooth connection ⇨ 86.

File formats and folders

The maximum capacity of a device supported by the Infotainment system amounts to 5000 music files, 5000 picture files, 500 movie files, 5000 folders and 15 stages of folder structure. Only devices formatted in the FAT16 / FAT32 file system are supported.

If there are images included in the audio metadata, these images are displayed on the screen.

Notice

Some files may not be played properly. This may be due to a different recording format or the condition of the file.

Files from online shops to which Digital Rights Management (DRM) has been applied cannot be played.

The Infotainment system can play the following audio, picture and movie files stored on external devices.

Audio files

The playable audio file formats are MP3 (MPEG-1 Layer 3, MPEG-2 Layer 3), WMA, AAC, AAC+, ALAC OGG WAF (PCM), AIFF, 3GPP (audio only), Audio Books and LPCM. iPod® and iPhone® devices play ALAC, AIFF, Audio Books and LPCM.

When playing a file with ID3 tag information, the Infotainment system can display information, e.g. on the track title and artist.

Picture files

The displayable picture file formats are JPG, JPEG, BMP, PNG and GIF. JPG files must be 64 to 5000 pixels in width and 64 to 5000 pixels in height. BMP, PNG and GIF files must be 64 to 1024 pixels in width and 64 to 1024 pixels in height.

The pictures should not exceed a file size of 1MB.

Movie files

The playable movie file formats are AVI and MP4.

The maximum resolution is 1280 x 720 pixels. The frame rate must be less than 30 fps.

The usable codec is H.264/MPEG-4 AVC.

The playable audio formats are MP3, AC3, AAC and WMA.

The displayable subtitle format is SMI.

Playing audio

Activating the music function

If the device is not yet connected to the Infotainment system, connect the device ↻ 77.

Usually, the respective audio main menu is displayed automatically.

If playback is not started automatically, e.g. if **USB Auto Launch** is deactivated ↻ 77, take the following steps:

Press  and then select **Audio** to open the audio main menu last selected.



Select **Source** in the interaction selector bar and then select the desired audio source to open the respective audio main menu.

Playback of the audio tracks starts automatically.



Function buttons

Interrupting and resuming playback

Touch  to interrupt playback. The screen button changes to .

Touch  to resume playback.

Playing the next or previous track

Touch  to play the next track.

Touch  within the first 2 seconds of the track playing to return to the previous track.

Returning to the beginning of the current track



Touch  after 2 seconds of the track playing.

Fast forwarding and rewinding

Touch and hold  or . Release to return to normal playback mode.

Alternatively, the slider showing the current track position can be moved to the left or right.

Playing tracks randomly

Touch  to play the tracks in random order. The screen button changes to .

Touch  again to deactivate the shuffle function and go back to the normal playback mode.

Browse Music function

To display the browse screen, touch the screen. Alternatively, select **Menu** in the audio main screen to display the respective audio menu and then select **Browse Music**.

Different categories, in which the tracks are sorted, are displayed, e.g. **Playlists**, **Artists**, or **Albums**.

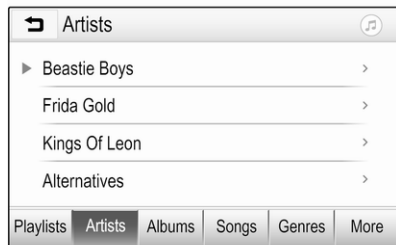

Select the desired category, subcategory (if available) and then choose a track.

Select the track to start playback.

Displaying pictures

Pictures from a USB device can be viewed.

Notice

For safety purposes, some features are disabled while driving.

Activating the picture function

If the device is not yet connected to the Infotainment system, connect the device ↗ 77.

Press and then select **Gallery** to open the media main menu.

Touch to open the picture main menu to display a list of items stored on the USB device. Select the desired picture. If this is stored within a folder, select the respective folder first.



Touch the screen to hide the menu bar. Touch the screen again to redisplay the menu bar.

Function buttons

Full screen mode

Select to display the picture in full screen mode. Touch the screen to exit full screen mode.

Viewing the next or previous picture

Touch or swipe to the left to view the next picture.

Touch or swipe to the right to view the previous picture.

Rotating a picture

Select to rotate the picture.

Zoom in on a picture

Touch once or several times to zoom in on a picture or to return to its original size.

Viewing a slide show

Select to view the pictures stored on the USB device in a slide show.

Touch the screen to end the slide show.

Picture menu

Select **Menu** in the bottom line of the screen to display the **Picture Menu**.

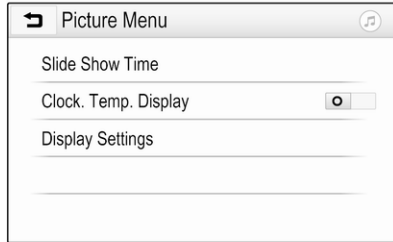

Slide show time

Select **Slide Show Time** to display a list of possible time sequences and select the desired time sequence.

Clock and temperature display

To display time and temperature in full screen mode, activate **Clock. Temp. Display**.

Display settings

Select **Display Settings** to open a submenu for the adjustment of brightness and contrast.

Touch **+** or **-** to adjust the settings.

Playing movies

Movies from a USB device can be viewed.

Notice

For safety purposes, the movie function is not available while driving.

Activating the movie function

If the device is not yet connected to the Infotainment system, connect the device [↪ 77](#).

Press **⌂** and then select **Gallery** to open the media main menu.

Touch **📺** to open the movie main menu to display a list of items stored on the USB device. Select the desired movie. If this is stored within a folder, select the respective folder first.

The movie is shown.



Function buttons

Full screen

Select **⌘** to display the movie in full screen mode. Touch the screen to exit full screen mode.

Interrupting and resuming playback

Touch **⏸** to interrupt playback. The screen button changes to **▶**.

Touch **▶** to resume playback.

Playing the next or previous track

Touch **▶|** to play the next movie file.

Touch **⏮** within the first 5 seconds of the movie playing to return to the previous movie file.

Returning to the beginning of the current movie

Touch **⏮** after 5 seconds of the movie playing.

Fast forwarding and rewinding

Touch and hold **⏮** or **⏭**. Release to return to normal playback mode.

Movie menu

Select **Menu** in the bottom line of the screen to display the **Movie Menu**.

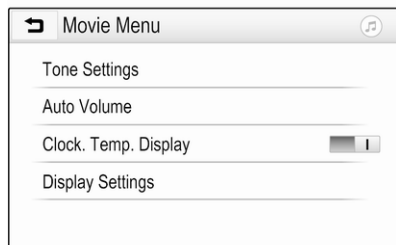

Clock and temperature display

To display time and temperature in full screen mode, activate **Clock. Temp. Display**.

Display settings

Select **Display Settings** to open a submenu for adjustment of brightness and contrast.

Touch **+** or **-** to adjust the settings.

Using smartphone applications

The phone projection applications Apple CarPlay™ and Android™ Auto display selected apps from a smartphone on the Info Display and allow their operation directly via the Infotainment controls.

Check with the device's manufacturer if this function is compatible with the smartphone and if this application is available in the country you are in.

Preparing the smartphone

Android phone: Download the Android Auto app to the smartphone from the Google Play™ Store.

iPhone: Make sure Siri® is activated on the smartphone.

Activating phone projection in the settings menu

Press **⏠** to display the home screen and then select **Settings**.

Scroll through the list to **Apple CarPlay** or **Android Auto**.

Make sure the respective application is activated.

Connecting the mobile phone

Connect the smartphone to the USB port **⇨** 77.

Starting phone projection

To start the phone projection function, press **⏠** and then select **Projection**.

Notice

If the application is recognised by the Infotainment system, the application icon may change to **Apple CarPlay** or **Android Auto**.

Alternatively, the function can be started by pressing **⏠** for a few seconds.

The phone projection screen displayed depends on the smartphone and software version.

Returning to the home screen

Press .

Speech recognition

General information	84
Usage	84



General information

The voice pass-thru application of the Infotainment system allows access to the speech recognition commands on a smartphone. See the smartphone manufacturer's operating instructions to find out whether the smartphone supports this feature.

In order to use the voice pass-thru application, the smartphone must be connected to the Infotainment system via USB cable ↗ 77 or via Bluetooth ↗ 86.



Usage

Activating speech recognition

Press and hold  on the control panel or  on the steering wheel to start a speech recognition session. A voice command message is displayed on the screen.

As soon as a beep is heard, a command can be said. For information on the commands supported, see the operating instructions of the smartphone.

Adjusting the volume of voice prompts

Turn  on the control panel or press  /  on the right side of the steering wheel to increase or decrease the volume of voice prompts.

Deactivating speech recognition

Press  on the steering wheel. The voice command message disappears and the speech recognition session is ended.

Phone

General information	85
Bluetooth connection	86
Operation	88
Mobile phones and CB radio equipment	92

General information

The phone function provides the possibility of having mobile phone conversations via a vehicle microphone and the vehicle loudspeakers as well as operating the most important mobile phone functions via the Infotainment system in the vehicle. To be able to use the phone function, the mobile phone must be connected to the Infotainment system via Bluetooth.

Not all phone functions are supported by every mobile phone. The usable phone functions depend on the relevant mobile phone and network provider. Further information on this can be found in the operating instructions of the mobile phone or by the network provider.

Important information for operation and traffic safety

Warning

Mobile phones have effects on the environment. For this reason, safety regulations and directions have been prepared. Be familiar with the related directions before using the telephone function.

Warning

Use of the hands-free facility while driving can be dangerous because the concentration is reduced when telephoning. Park the vehicle before using the hands-free facility. Follow the stipulations of the country you are in.

Do not forget to follow the special regulations that apply in specific areas and always switch off the mobile phone if the use of mobile phones is prohibited, if

interference is caused by the mobile phone or if dangerous situations can occur.

Bluetooth

The phone function is certified by the Bluetooth Special Interest Group (SIG).

Further information about the specification can be found on the Internet at <http://www.bluetooth.com>.

Bluetooth connection

Bluetooth is a radio standard for the wireless connection of e.g. mobile phones, smartphones or other devices.

The pairing and connecting of the Bluetooth devices to the Infotainment system are carried out via the **Bluetooth** menu. Pairing is the PIN code exchange between the Bluetooth device and the Infotainment system.

Bluetooth menu

Press  and then select **Settings**.

Select **Bluetooth** to display the Bluetooth menu.

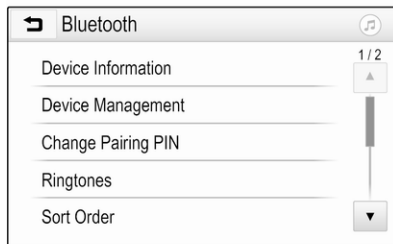

Pairing a device

Important information

- Up to ten devices can be paired to the system.
- Only one paired device can be connected to the Infotainment system at a time.
- Pairing only needs to be carried out once, unless the device is deleted from the list of paired devices. If the device has been

connected previously, the Infotainment system establishes the connection automatically.

- Bluetooth operation considerably drains the device's battery. Therefore, connect the device to the USB port for charging.

Pairing a new device

1. Activate the Bluetooth function of the Bluetooth device. For further information, see the operating instructions of the Bluetooth device.
2. Press  and then select **Settings** on the display. Select **Bluetooth** and then **Device Management** to display the respective menu.



Notice

If no phone is connected, the **Device Management** menu can also be accessed via the phone menu: Press and then select **Phone**.

3. Touch **Search Device**. All discoverable Bluetooth devices in the environment are displayed in a new search list.
4. Touch the respective Bluetooth device.
5. Confirm the pairing procedure:
 - If SSP (secure simple pairing) is supported:

Confirm the messages on the Infotainment system and the Bluetooth device.

- If SSP (secure simple pairing) is not supported:

On the Infotainment system: an **Info** message is displayed asking to enter a PIN code on the Bluetooth device.

On the Bluetooth device: enter the PIN code and confirm the input.

6. The Infotainment system and the device are paired.

Notice

If the Bluetooth device is successfully paired, next to the Bluetooth device indicates that the phone function is enabled and indicates that the Bluetooth music function is enabled.

7. The phone book is downloaded automatically to the Infotainment system. Depending on the phone, the Infotainment system must be allowed access to the phone book. If required, confirm the

messages displayed on the Bluetooth device.

If this function is not supported by the Bluetooth device, a corresponding message is displayed.

Changing the Bluetooth PIN code

Press and then select **Settings**.

Select **Bluetooth** and then **Change Pairing PIN** to display the respective submenu. A keypad is displayed.

Enter the desired four-digit PIN code.

To delete an entered number, select .

Confirm the input by selecting **Enter**.

Connecting a paired device

Press and then select **Settings**.

Select **Bluetooth** and then **Device Management** to display the respective menu.

Select the respective Bluetooth device. The device is connected.

Notice

The connected device and the available options are highlighted.

Disconnecting a device

Press  and then select **Settings**.

Select **Bluetooth** and then **Device Management** to display the respective menu.

Select the Bluetooth device currently connected. A message will be displayed.

Select **Yes** to disconnect the device.

Deleting a device

Press  and then select **Settings**.

Select **Bluetooth** and then **Device Management** to display the respective menu.

Select  next to the Bluetooth device. A message will be displayed.

Select **Yes** to delete the device.

Device info

Press  and then select **Settings**.

Select **Bluetooth** and then **Device Information** to display the respective menu.

The information displayed includes **Device Name**, **Address**, and **PIN Code**.

Operation

As soon as a connection via Bluetooth has been set up between the mobile phone and the Infotainment system, many functions of the mobile phone can be operated via the Infotainment system.

Notice

In the hands-free mode, mobile phone operation is still possible, e.g. taking a call or adjusting the volume.

After setup of a connection between the mobile phone and the Infotainment system, mobile phone data is transmitted to the Infotainment system. This can take some time depending on the mobile phone and the amount of data to be transferred. During this period, operation of the mobile phone via the Infotainment system is possible only to a limited extent.

Notice

Not every mobile phone fully supports the phone function. Therefore, deviations from the range of functions described below are possible.

Phone main menu

Press  and then select **Phone** to display the respective menu.

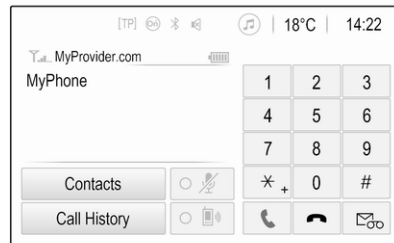

Notice

The **Phone** main menu is only available if a mobile phone is connected to the Infotainment system via Bluetooth. For a detailed description  86.

Many functions of the mobile phone can now be controlled via the phone main menu (and associated submenus), and via the phone-specific controls on the steering wheel.

Initiating a phone call

Entering a phone number

Press  and then select **Phone**.

Enter a telephone number using the keypad in the phone main menu.

To delete one or more entered characters, touch or touch and hold .

Touch  to start dialling.

Using the phone book

Notice

When pairing a mobile phone with the Infotainment system via Bluetooth, the phone book of the mobile phone is downloaded automatically  86.

Press  and then select **Phone**.

Select **Contacts** in the phone main menu.



Notice

The  symbol next to a phone number indicates that the contact is stored on the SIM card.

Quick search

1. Select  to display a list of all contacts.
2. Scroll through the list of contacts entries.
3. Touch the desired contact. A menu with all phone numbers stored for the selected contact is displayed.
4. Select the desired phone number to initiate the call.

Search menu

If the phone book contains a large number of entries, the search menu can be used to find the desired contact.

Select  in the **Contacts** menu to display the search tab.

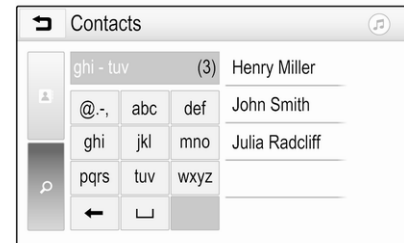

The letters are organised in alphabetical groups on the screen buttons: **abc**, **def**, **ghi**, **jkl**, **mno**, **p qrs**, **tuv**, and **wxyz**.

Use  to delete an entered group of letters.

1. Select the button containing the first letter of the desired contact.

E.g.: If the desired contact starts with 'g' select the **ghi** screen button.

All contacts containing one of the letters on this button, in the example 'g', 'h', and 'i', are displayed.

2. Select the button containing the second letter of the desired contact.
3. Continue to enter more letters of the desired contact until the desired contact is displayed.
4. Touch the desired contact. A menu with all phone numbers stored for the selected contact is displayed.
5. Select the desired phone number to initiate the call. The following screen is shown.



Contacts settings

The contacts list can be sorted by last name or first name.

Press and then select **Settings** to display the respective menu.

Select **Bluetooth** and then **Sort Order**. Activate the desired option.

Using the call history

All incoming, outgoing, or missed calls are registered.

Press and then select **Phone**.

Select **Call History** in the phone main menu.

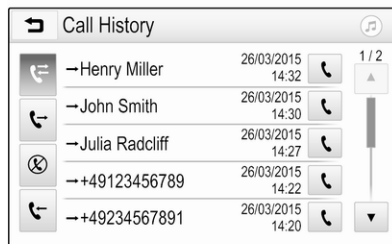

Select for outgoing calls, for missed calls, for incoming calls and for all calls. The respective call list is displayed.

Select the desired entry to initiate a call.

Redialling a number

The last dialled phone number can be redialled.

Press , select **Phone** and then select .

Using speed dial numbers

Speed dial numbers that are stored on the mobile phone can also be dialled using the keypad of the phone main menu.

Press  and then select **Phone**.

Touch and hold the respective digit on the keypad to initiate the call.

Incoming phone call

Taking a call

If an audio mode, e.g. the radio or USB mode, is active at the moment a call comes in, the audio source is muted and stays muted until the call ends.

A message with the caller's phone number or name (if available) is displayed.



To answer the call, select .

Rejecting a call

To reject the call, select .

Changing the ring tone

Press  and then select **Settings**.

Select **Bluetooth** and then **Ringtones** to display the respective menu. A list of all paired devices is displayed.

Select the desired device. A list of all ringtones available for this device is displayed.

Select one of the ringtones.

Functions during a call

During an ongoing phone call, the phone main menu is displayed.



Deactivating the hands-free mode temporarily

To continue the conversation via the mobile phone, activate .

To return to the hands-free mode, deactivate .

Deactivating the microphone temporarily

To mute the microphone, activate .

To reactivate the microphone, deactivate .

Ending a phone call

To end the call, select .

Voice mail box

The voice mail box can be operated via the Infotainment system.

Voice mail number

Press  and then select **Settings**.

Select **Bluetooth**. Scroll through the list and select **Voice Mail Numbers**.

A list of all paired devices is displayed.

Select the respective phone. A keypad is displayed.

Enter the voice mail number for the respective phone.

Calling the voice mail box

Press  and then select **Phone**.

Select  on the screen. The mail box is called.

Alternatively, enter the voice mail number via the phone keypad.

Mobile phones and CB radio equipment

Installation instructions and operating guidelines

The vehicle specific installation instructions and the operating guidelines of the mobile phone and hands-free manufacturer must be observed when installing and operating a mobile telephone. Failure to do so could invalidate the vehicle type approval (EU directive 95/54/EC).

Recommendations for fault-free operation:

- Professionally installed exterior antenna to obtain the maximum range possible.
- Maximum transmission power 10 W.
- Installation of the phone in a suitable spot, consider relevant Note in the Owner's Manual, section **Airbag system**.

Seek advice on predetermined installation points for the external antenna or equipment holder and ways of using devices with a transmission power exceeding 10 W.

Use of a hands-free attachment without external antenna with mobile telephone standards GSM 900/1800/1900 and UMTS is only permitted if the maximum transmission power of the mobile telephone is 2 W for GSM 900 or 1 W for the other types.

For reasons of safety, do not use the phone while driving. Even use of a hands-free set can be a distraction while driving.

Warning

Operation of radio equipment and mobile telephones which fail to meet above mentioned mobile telephone standards is only permitted using an antenna located outside of the vehicle.

Caution

Mobile telephones and radio equipment may lead to malfunctions in the vehicle electronics when operated inside the vehicle with no exterior antenna, unless the above mentioned regulations are observed.

Index

A

Activating Bluetooth music.....	79
Activating phone.....	88
Activating radio.....	71
Activating USB audio.....	79
Activating USB movie.....	81
Activating USB picture.....	80
Audio files.....	77
Auto volume.....	67

B

Basic operation.....	65
Bluetooth	
Bluetooth connection.....	86
Bluetooth music menu.....	79
Connecting device.....	77
General information.....	77
Pairing.....	86
Phone.....	88
Bluetooth connection.....	86

C

Call	
Functions during a call.....	88
Incoming call.....	88
Initiating a phone call.....	88
Ring tone.....	88
Call history.....	88

Control elements

Infotainment system.....	59
Steering wheel.....	59
Control elements overview.....	59

D

DAB.....	74
Digital audio broadcasting.....	74
Displaying pictures.....	80
Display settings.....	80, 81

F

Favourite lists.....	73
Retrieving stations.....	73
Storing stations.....	73
File formats	
Audio files.....	77
Movie files.....	77
Picture files.....	77

G

General information.....	77, 84, 85
Bluetooth.....	77
DAB.....	74
Infotainment system.....	58
Phone.....	85
Smartphone applications.....	77
USB.....	77

H			
Home menu.....	65		
Home screen.....	65		
I			
Infotainment control panel.....	59		
Intellitext.....	74		
M			
Maximum startup volume.....	67		
Menu operation.....	65		
Mobile phones and CB radio equipment	92		
Movie files.....	77		
Mute.....	62		
O			
Operation.....	88		
External devices.....	77		
Menu.....	65		
Phone.....	88		
Radio.....	71		
P			
Pairing.....	86		
Phone			
Bluetooth.....	85		
Bluetooth connection.....	86		
Call history.....	88		
Entering a number.....	88		
Functions during a call.....	88		
General information.....	85		
Incoming call.....	88		
Phone book.....	88		
Phone main menu.....	88		
Selecting the ring tone.....	88		
Speed dial number.....	88		
Phone book.....	88		
Phone projection.....	82		
Picture files.....	77		
Playing audio.....	79		
Playing movies.....	81		
R			
Radio			
Activating.....	71		
Configuring DAB.....	74		
Configuring RDS.....	73		
DAB announcements.....	74		
Digital audio broadcasting (DAB).....	74		
Favourite lists.....	73		
Intellitext.....	74		
Radio data system (RDS).....	73		
Regional.....	73		
Regionalisation.....	73		
Retrieving stations.....	73		
Selecting the waveband.....	71		
Station search.....	71		
Station tuning.....	71		
Storing stations.....	73		
Usage.....	71		
Radio data system	73		
RDS.....	73		
Regional.....	73		
Regionalisation.....	73		
Retrieving stations.....	73		
Ring tone			
Changing the ring tone.....	88		
Ring tone volume.....	67		
S			
Smartphone.....	77		
Phone projection.....	82		
Speech recognition.....	84		
Speed dial numbers.....	88		
Station search.....	71		
Steering wheel audio controls.....	59		
Storing stations.....	73		
Switching the Infotainment system on.....	62		
System settings.....	68		
T			
Theft-deterrent feature	58		
Tone settings.....	66		
Touch beep volume.....	67		
TP volume.....	67		

U

Usage.....	62, 71, 84
Bluetooth.....	77
Menu.....	65
Phone.....	88
Radio.....	71
USB.....	77
USB	
Connecting device.....	77
General information.....	77
USB audio menu.....	79
USB movie menu.....	81
USB picture menu.....	80
Using smartphone applications....	82

V

Voice recognition.....	84
Volume	
Auto volume.....	67
Maximum startup volume.....	67
Mute function.....	62
Ring tone volume.....	67
Setting the volume.....	62
Speed compensated volume....	67
Touch beep volume.....	67
TP volume.....	67
Volume limitation at high temperatures.....	62
Volume settings.....	67

W

Waveband selection.....	71
-------------------------	----

R 4.0

Introduction	98
Basic operation	104
Radio	108
USB port	112
Bluetooth music	114
Speech recognition	116
Phone	117
Index	124

Introduction

General information	98
Theft-deterrent feature	98
Control elements overview	99
Usage	102

General information

Notice

This manual describes all options and features available for the various Infotainment systems. Certain descriptions, including those for display and menu functions, may not apply to your vehicle due to model variant, country specifications, special equipment or accessories.

Important information on operation and traffic safety

Warning

Drive safely at all times when using the Infotainment system.
If in doubt, stop the vehicle before operating the Infotainment system.

Radio reception

Radio reception may be disrupted by static, noise, distortion or loss of reception due to:

- changes in distance from the transmitter
- multi-path reception due to reflection
- shadowing

Theft-deterrent feature



The Infotainment system is equipped with an electronic security system for the purpose of theft deterrence.

The Infotainment system therefore functions only in your vehicle and is worthless to a thief.

Control elements overview

Control panel



- 1** 
If switched off: short press: switch power on 102
If switched on: short press: mute system; long press: switch power off 102
Turn: adjust volume 102
- 2** Preset buttons
Short press: select favourites 108
Long press: save radio stations as favourites 108
- 3** **AUDIO**
Short press: open menu for tone and volume settings 105
- 4** 
Short press: toggle through the different display modes 102
Long press: turn display off (while the sound remains active) 102
- 5** 
Radio: short press: manual station search 108
Media: short press: select next or previous folder, genre, artist or playlist; long press: scroll in a list 112
< / >
Radio: short press: automatic station search for the previous or next station; long press: seek up or down 108
Media: short press: select previous or next track; long press: fast forward or rewind 112
- 6** **OK**
Short press: confirm a setting or open a submenu . 104
- 7** **MENU**
Short press: display home page 104
- 8** **BAND**
Short press: toggle between the wavebands 108
- 9** Info Display
- 10** **TA**
Short press: activate or deactivate traffic announcements 109
Long press: open the TA settings 110
- 11** **LIST**
Radio: short press: display stations list; long press: update stations list 108
Media: short press: display folders list; long press: display the track listing options 112
- 12** **BACK**
Menu: one level back 104
Input: delete last character or entire entry 119

13 SRC

Short press: toggle between the audio sources . 108

Long press: open phone menu if phone connected ... 119

Steering wheel controls

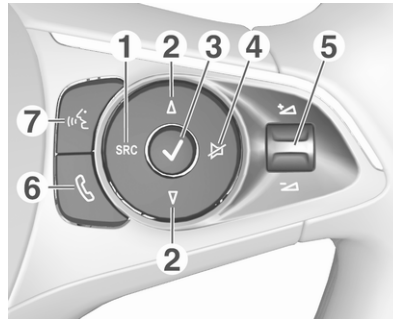

- 1 **SRC**
Select audio source, confirm selection with ✓ 102
- 2 **Δ / ▽**
Select next / previous preset radio station when radio active 108
or select next / previous track when media sources active 112

or select next / previous entry in call / contacts list when phone function active and call / contact list open 119

Confirm selection with ✓

3 ✓

Confirm selected item

Open list

4 **⏪**

Activate/deactivate mute function 102

5 **+ / -**

Turn upwards / downwards: increase / decrease volume

6 **☎**

Take phone call 119

or reject phone call 119

or open call / contacts list ... 119

7 

Activate voice pass-thru application 116

Usage

Control elements

The Infotainment system is operated via function buttons, navigation buttons and menus that are shown on the display.

Inputs are made optionally via:

- the control panel on the Infotainment system ⇨ 99
- controls on the steering wheel ⇨ 99

Switching the Infotainment system on or off

Press  briefly. After switching on, the last selected Infotainment source becomes active.

Notice

Some functions of the Infotainment system are only available if ignition is switched on or engine is running.

Press  again to turn the system off.



Automatic switch-off

If the Infotainment system is switched on by pressing  while the ignition is switched off, it switches off again automatically after a certain time.

Setting the volume

Turn . The current setting is shown on the display.

When the Infotainment system is switched on, the last selected volume is set.

Speed compensated volume

When the automatic volume function is activated ⇨ 105, the volume is adapted automatically to make up for the road and wind noises as you drive.

Mute function

Press  on the steering wheel to mute the audio sources.

To cancel the mute function, press  again.

Changing the display mode

There are three different display modes available:

- full screen display
- splitted display with time and date information shown on the left side of the screen
- black display

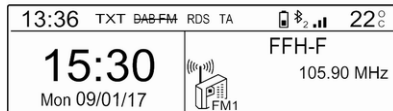

Repeatedly press  to toggle between full screen display mode and splitted display mode.

Press and hold  to turn the display off while the sound remains active.

Press  again to reactivate the display.

Modes of operation

Radio

Repeatedly press **BAND** to toggle between the different wavebands and select the desired waveband.

For a detailed description of the radio functions ⇨ 108.

USB port

Repeatedly press **SRC**  to toggle between the different audio sources and select USB mode.

For a detailed description on connecting and operating external devices ⇨ 112.

Bluetooth music

Repeatedly press **SRC**  to toggle between the different audio sources and select Bluetooth music mode.

For a detailed description on connecting and operating external devices ⇨ 114.

Phone

Before the phone function can be used, a connection to a Bluetooth device has to be established. For a detailed description ⇨ 118.

Press **MENU** to display the home page. Select **Telephone** by pressing **<** and **>** and then press **OK** to confirm. The phone menu is displayed.

For a detailed description of mobile phone operation via the Infotainment system ⇨ 119.

Basic operation

Basic operation	104
Tone and volume settings	105
System settings	106

Basic operation

OK button

Press **OK**:

- to confirm or activate the selected option
- to confirm a set value
- to activate or deactivate a function
- to open a menu

BACK button

Press **BACK**:

- to exit a menu
- to return from a submenu to the next higher menu level

Examples of menu operation

Selecting an option

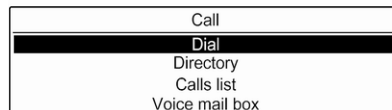

Press **^**, **v**, **<** or **>** to move the cursor (= coloured background) to the desired option.

Press **OK** to confirm the selected option.

Activating a setting

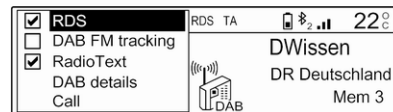

Press **^**, **v**, **<** or **>** to select the desired setting.

Press **OK** to activate the setting.

Setting a value

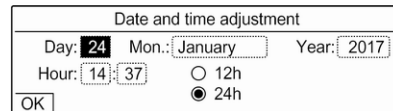

Press **<** or **>** to select the current value of the setting.

Press **OK** to confirm the selection.

Press \langle or \rangle to adjust the desired value.

Press **OK** to confirm the set value.

The cursor then switches to the value of the next setting. To switch to the value of another setting, press \wedge , \vee , \langle or \rangle . If the values of all settings are set, select **OK** on the display and press **OK**.

Adjusting a setting

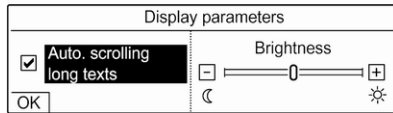

Select the desired setting and press **OK**.

Press \langle or \rangle until the setting is adjusted as desired.

Select **OK** on the display and press **OK** to confirm the setting.

Entering a character sequence

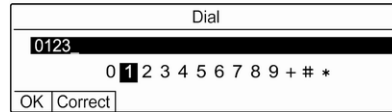

To enter character sequences, e.g. telephone numbers:

Press \langle or \rangle to select the desired character.

Press **OK** to confirm the selected character.

The last character in the character sequence can be deleted by selecting **Correct** on the display and pressing **OK**.

To change the position of the cursor in the character sequence already entered, select the character sequence and press \langle or \rangle to move the cursor to the desired position.

To confirm the character sequence, press \vee to select **OK** on the display and then press **OK**.

Tone and volume settings

In the tone and volume settings menu, the tone characteristics and volume settings can be adjusted.

The settings on page 1 can be set individually for each audio source. The settings on page 2 are set for all audio sources.

Press **AUDIO** to open the tone and volume settings menu.

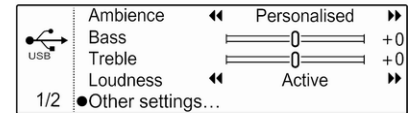

Press **AUDIO** again to display the second tone and volume settings page. Alternatively, select **Other settings...**

Sound adjustment

To change the sound of the Infotainment system, select a tone style or adjust the tone characteristics manually.

Tone style

To activate a tone style, select **Ambience**. To toggle between the different tone styles, repeatedly press < or >.

If the tone style is set to **Personalised**, **Bass** and **Treble** can be set manually.

Bass and treble

To enhance or attenuate the deep frequencies, select **Bass**.

To enhance or attenuate the high frequencies, select **Treble**.

Repeatedly press < or > to adjust the settings.

Notice

If the settings of **Bass** or **Treble** are adjusted, the tone style is set to **Personalised**.

Loudness

The Infotainment system has a loudness compensation function for better sound quality at low volume levels. It is set to **Active** by default.

To change the loudness setting, select **Loudness**. Press < or > to toggle between the settings **Active** and **Inactive**.

Volume distribution

The volume distribution within the passenger compartment can be optimised for the driver or for all passengers.

Select **Distribution**. Press < or > to toggle between the settings **Driver** and **All passengers**.

If **Driver** is selected, the volume balance is automatically optimised for the driver.

If **All passengers** is selected, the volume distribution between left and right in the passenger compartment can be set manually.

Select **Balance**. Repeatedly press < to move the point of the highest sound level to the left or > to move the point of the highest sound level to the right.

Automatic volume adjustment

The volume of the Infotainment system can be adjusted automatically according to the speed of the vehicle.

Select **Auto. volume**. Press < or > to toggle between the settings **Active** and **Inactive**.

System settings

Configuring the system

Open the settings menu to perform some basic system configurations, e.g.:

- Adjust the display of units for temperature or fuel consumption
- Change the display language
- Adjust date and time

Changing display language

Press **MENU** and then select **Personalisation-configuration**.

Select **Display configuration** and then select **Choice of language**.

To adjust the language for the menu texts, select the desired language and press **OK**.

Adjusting time and date

Press **MENU** and then select **Personalisation-configuration**.

Select **Display configuration** and then select **Date and time adjustment**.

Changing the time format

To change the time format, select **12h** or **24h** and press **OK**.

Date and time adjustment			
Day:	<input type="text" value="24"/>	Mon.:	<input type="text" value="January"/>
Year:	<input type="text" value="2017"/>		
Hour:	<input type="text" value="14"/>	<input type="text" value="37"/>	<input type="radio"/> 12h <input checked="" type="radio"/> 24h
<input type="button" value="OK"/>			

Setting time and date

By default the displayed time and date is automatically adjusted by the system.

To manually adjust the displayed time and date:

Select the value of the desired settings, e.g. **Day** and press **OK**.

Press \wedge or \vee to set the desired value and press **OK** to confirm.

To confirm the set date and time, select **OK** on the display.

Adjusting the screen

Press **MENU** and then select **Personalisation-configuration**.

Select **Display configuration** and then select **Display personalisation**.

Text scroll function

If long texts on the screen should be scrolled automatically, activate **Auto. scrolling long texts**.

Display parameters	
<input checked="" type="checkbox"/> Auto. scrolling long texts	Brightness <input type="text" value="0"/> \pm
<input type="button" value="OK"/>	C

Select **OK** on the display.

If **Auto. scrolling long texts** is deactivated, long texts are truncated.

Adjusting the brightness

In the **Brightness** section, select \oplus or \ominus to increase or decrease the brightness of the screen.

Press **OK** to confirm and then repeatedly press **OK** to adjust the brightness to the desired level.

To confirm the brightness adjustment, select **OK** on the display.

Adjusting the units for temperature and fuel consumption

Press **MENU** and then select **Personalisation-configuration**.

Select **Display configuration** and then select **Choice of units**.

Select the desired unit and press **OK**.

Choice of units	
<input checked="" type="radio"/> l/100 km	<input checked="" type="radio"/> °Celsius
<input type="radio"/> mpg	<input type="radio"/> °Fahrenheit
<input type="radio"/> km/l	
<input type="button" value="OK"/>	

Select **OK** on the display.

Radio

Usage	108
Station search	108
Radio data system	109
Digital audio broadcasting	110

Usage

Repeatedly press **BAND** to toggle between the different wavebands. Select the desired waveband.

As an alternative, repeatedly press **SRC**  to toggle between all audio sources and select the desired waveband.

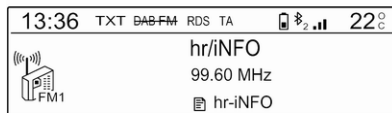

The station last selected in the respective waveband is played.

Station search

Automatic station search

Press **<** or **>** to play the previous or next station in the station memory.

Manual station search

Press and hold **<** or **>**. Release when the required frequency has almost been reached.

A search is made for the next station that can be received and it is played automatically.

Station tuning

Press or press and hold **^** or **v** to set the desired frequency manually.

Stations lists

The stations received best in the location you are in are stored in the waveband-specific stations list.

Displaying the stations list

Press **LIST** to display the stations list of the waveband currently active.

Scroll through the list and select the desired station.

Notice

The station currently playing is marked with **▶**.

Updating the stations list

Press and hold **LIST** until a message indicating the update process is displayed.

The stations list is updated.

Preset buttons

The six favourite radio stations of each waveband can be stored on preset buttons. When pressing one of the preset buttons, the favourites page is displayed.

Notice

The station currently playing is marked with ►.

Storing preset stations

To store a station to a preset button, activate the desired waveband and station. When the station is playing, press and hold one of the preset button **1...6** on which the desired station is to be stored.

The station name or frequency is displayed next to the respective favourite on the screen.

Retrieving preset stations

To retrieve a station stored as a favourite, press the respective preset button **1...6**.

Radio data system

Radio data system (RDS) is a service of FM stations that considerably facilitates the finding of the desired station and its fault-free reception.

Alternative frequencies

If the FM signal of a station is too weak to be picked up by the receiver, the Infotainment system can automatically tune to an alternative FM frequency to continue the programme.

Activate the FM waveband and then press **OK** to display the waveband menu. Activate **RDS**.

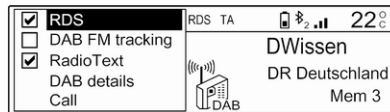

If RDS alternative frequency search is activated, **RDS** is displayed in the top line of the screen. If a station is not an RDS station, **RDS** is crossed out.

Notice

This function can also be changed via the multimedia menus. Press **MENU** and then select **Multimedia**.

Radio text

Radio text contains additional information broadcasted by the radio stations, e.g. station name, title or artist of the song currently playing, news information etc.

Activate the FM waveband and then press **OK** to display the waveband menu. Activate **RadioText**.

If the radio text function is activated, **TXT** is displayed in the top line of the screen. If a station does not support the radio text function, **TXT** is crossed out.

Notice

This function can also be changed via the multimedia menus. Press **MENU** and then select **Multimedia**.

Traffic announcements (TA)

Radio traffic service stations are RDS stations that broadcast traffic news. If this function is activated, only traffic service stations are searched for and played.

Radio and media playback is interrupted for the duration of the traffic announcements.

To activate or deactivate the traffic announcement standby facility of the Infotainment system, press **TA**. A corresponding message is displayed confirming your action.

If traffic announcements are activated, **TA** is displayed in the top line of the screen. If a station is not a radio traffic service station, **TA** is crossed out.

Digital audio broadcasting

Digital audio broadcasting (DAB) broadcasts radio stations digitally.

DAB stations are indicated by the programme name instead of the broadcasting frequency.

General information

- With DAB, several radio programmes (services) can be broadcasted on a single ensemble.
- Besides high-quality digital audio services, DAB is also able to transmit programme-associated data and a multitude of other data services including travel and traffic information.
- As long as a given DAB receiver can pick up the signal sent out by a broadcasting station (even if the signal is very weak), sound reproduction is ensured.
- In the event of poor reception, the volume is reduced automatically to avoid the output of disagreeable noises.
- Interference caused by stations that are on nearby frequencies (a phenomenon that is typical of AM and FM reception) does not occur with DAB.
- If the DAB signal is reflected by natural obstacles or buildings, the reception quality of DAB is

improved, whereas AM or FM reception is considerably impaired in such cases.

- When DAB reception is enabled, the FM tuner of the Infotainment system remains active in the background and continually searches for the best receivable FM stations. If TA ⇨ 109 is activated, traffic announcements of the FM station with the best reception are issued. Deactivate TA if DAB reception should not be interrupted by FM traffic announcements.

Alternative frequencies

If the DAB signal of a service is too weak to be picked up by the receiver, the Infotainment system can automatically tune to an alternative FM frequency to continue the programme.

Activate the FM waveband and then press **OK** to display the waveband menu. Activate **DAB FM tracking**.

Notice

This function can also be changed via the multimedia menus. Press **MENU** and then select **Multimedia**.

If DAB FM automatical tracking is activated, **DAB FM** is displayed in the top line of the screen. If a station does not support this function, **DAB FM** is crossed out.

DAB station details

Activate the FM waveband and then press **OK** to display the waveband menu.

Select **DAB details** to display detailed information on the DAB station currently playing.

USB port

General information 112
Playing saved audio files 112

General information

In the centre console, there is a USB port for the connection of external audio data sources.

Notice

The socket must always be kept clean and dry.

Connecting a USB device

An MP3 player, USB device or SD card (via USB connector / adapter) can be connected to the USB port. A USB hub is not supported. If required, use the appropriate connection cable.

Notice

Not all auxiliary devices are supported by the Infotainment system. Check the compatibility list on our website.

When connected to the USB port, various functions of the above devices can be operated via the controls and menus of the Infotainment system.

The Infotainment system automatically creates playlists upon connection.

Disconnecting a USB device

Press **SRC**  to select a different audio source and then remove the USB storage device.

Caution

Avoid disconnecting the device during playback. This may damage the device or the Infotainment system.

File formats

The audio equipment supports different audio file formats.

Playing saved audio files

Activating the USB music function

If the device is not yet connected to the Infotainment system, connect the device.

The Infotainment system automatically switches to USB music mode.

If the device is already connected, repeatedly press **SRC** to change to USB music mode.

Playback of the audio tracks starts automatically.

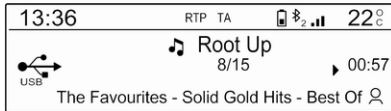

Playing the next or previous track

Press **>** to play the next track.

Press **<** to play the previous track.

Fast forwarding and rewinding

Press and hold **<** or **>**. Release to return to normal playback mode.

Playing the next or previous folder / artist / playlist

Press **^** to play the next folder, artist, album, or playlist depending on the track listing options.

Press **^** to play the previous folder, artist, album, or playlist depending on the track listing options.

Browse menu

Using the browse menu, you can search for a track via categories.

Browse function

To display the browse list, press **LIST**. The tracks are sorted in categories of folders, genres, artists, and playlists.

Select the desired categories and choose a track. Select the track to start playback.

Choice of track listing

Press and hold **LIST** to display a selection menu. Scroll through the list and select the desired track listing option. The browse menu is changed accordingly.

Notice

Depending on the metadata stored on the device, not all track listing options may be available.

Notice

This function can also be changed via the multimedia menus. Press **MENU** and then select **Multimedia**.

USB music menu

In the USB music menu, you can set the play mode for the tracks on the device connected.

Activate the USB music mode and then press **OK** to display the USB music menu.

Activate the desired play mode.

Normal: The songs of the album, folder or playlist chosen are played in the usual order.

Random: The songs of the album, folder or playlist chosen are played in random order.

Random all: All tracks stored on the device connected are played in random order.

Repeat: The album, folder or playlist chosen is played repeatedly.

Bluetooth music

General information	114
Operation	114

General information

Connecting a Bluetooth device

Bluetooth enabled audio sources (e.g. music mobile phones, MP3 players featuring Bluetooth, etc.) can be connected wirelessly to the Infotainment system.

The external Bluetooth device must be paired to the Infotainment system ↻ 118.

If the device is paired but not connected to the Infotainment system, establish the connection via the **Connections management** menu:

Press **MENU** and then select **Connections**. Select **Connections management** and then choose the desired Bluetooth device to enter a submenu.

To serve as audio source, the device must be connected as media player. Select **Connect media player** or **Connect telephone + media player** as desired. The device is connected.

Disconnecting a Bluetooth device

Press **MENU** and then select **Connections**. Select **Connections management** and then choose the desired Bluetooth device to enter a submenu.

Select **Disconnect media player** to disconnect the device only as Bluetooth audio source. In this case, the connection for the telephone function remains active.

To completely disconnect the device, select **Disconnect telephone + media player**.

Select **Yes** in the message and press **OK**.

Operation

Activating the USB music function

If the device is not yet connected to the Infotainment system, connect the device ↻ 118.

The Infotainment system automatically switches to Bluetooth music mode.

If the device is already connected, repeatedly press **SRC**  to change to Bluetooth music mode.

If music playback does not start automatically, it may be required to start the audio files from the Bluetooth device.

Playing the next or previous track

Press **>** to play the next track.

Press **<** to play the previous track.

Speech recognition

General information 116
Usage 116

General information

The voice pass-thru application of the Infotainment system allows access to the speech recognition commands on a smartphone. See the smartphone manufacturer's operating instructions to find out whether the smartphone supports this feature.



In order to use the voice pass-thru application, the smartphone must be connected via Bluetooth ⇨ 118.

Usage

Activating speech recognition

Press and hold  on the steering wheel until a speech recognition session is started.

Adjusting the volume of voice prompts

Turn  on the control panel or press the volume button on the steering wheel upwards (increase volume)  or downwards (decrease volume) .

Deactivating speech recognition

Press  on the steering wheel. The speech recognition session is ended.

Phone

General information	117
Bluetooth connection	118
Operation	119
Mobile phones and CB radio equipment	121

General information

The Phone function provides you with the possibility of having mobile phone conversations via a vehicle microphone and the vehicle loudspeakers as well as operating the most important mobile phone functions via the Infotainment system in the vehicle. To be able to use the Phone function, the mobile phone must be connected to the Infotainment system via Bluetooth.

Not all functionalities of the Phone function are supported by every mobile phone. The possible functionalities depend on the relevant mobile phone and network provider. You will find further information on this in the operating instructions for your mobile phone or you can enquire about them with your network provider.

Important information for operation and traffic safety

Warning

Mobile phones have effects on your environment. For this reason safety regulations and directions have been prepared. You should be familiar with the related directions before you use the telephone function.

Warning

Use of the hands-free facility while driving can be dangerous because your concentration is reduced when telephoning. Park your vehicle before you use the hands-free facility. Follow the stipulations of the country in which you find yourself at present.

Do not forget to follow the special regulations that apply in specific areas and always switch off the mobile phone if the use of mobile phones is prohibited, if

interference is caused by the mobile phone or if dangerous situations can occur.

Bluetooth

The Phone function is certified by the Bluetooth Special Interest Group (SIG).

You will find further information about the specification on the Internet at <http://www.bluetooth.com>

Bluetooth connection

Bluetooth is a radio standard for the wireless connection of e.g. a telephone with other devices. Data such as a telephone book, call lists, the network operator's name, and field strength can be transferred. The functionality can be restricted depending on the telephone type.

Pairing a Bluetooth device

Activate the Bluetooth function of the Bluetooth device. For further information, see the operating instructions for the Bluetooth device.

Press **MENU**, select **Connections** and press **OK**.

Select **Search for a device** and press **OK**. As soon as the device is detected, the list **Devices detected** is displayed.

- If SSP (secure simple pairing) is supported: Confirm the messages on the Infotainment system and the Bluetooth device.
- If SSP (secure simple pairing) is not supported: On the Infotainment system: a message is displayed asking you to enter a PIN code on your Bluetooth device. On the Bluetooth device: enter the PIN code and confirm your input.

The device is automatically connected. In the top line of the display, the Bluetooth symbol is changed: The **X** of the symbol is suppressed and **⌘** is shown.

Notice

Your mobile phone book will be downloaded automatically. The presentation and order of the telephone book entries may be

different on the Infotainment system's display and the mobile phone's display.

If the Bluetooth connection has been successfully performed: in case another Bluetooth device had been connected to the Infotainment system, this device is now disconnected from the system.

If the Bluetooth connection failed: start the procedure described above again or consult the operating instructions for the Bluetooth device.

Connecting another paired device

Activate the Bluetooth function of the Bluetooth device. For further information, see the operating instructions for the Bluetooth device.

Press **MENU**, select **Connections** and press **OK**.

Select **Connections management** and press **OK**. A list of all Bluetooth devices currently paired to the Infotainment system is displayed.

Notice

The Bluetooth device currently connected to the Infotainment system is indicated by .

To establish the connection, select the desired device and press **OK**.

Disconnecting a device

Press **MENU**, select **Connections** and press **OK**.

Select **Connections management** and press **OK**. A list of all Bluetooth devices currently paired to the Infotainment system is displayed.

Notice

The Bluetooth device currently connected to the Infotainment system is indicated by .

Select the device currently connected to the Infotainment system.

Press **OK** to confirm your selection.

Select **Disconnect telephone**.

To disconnect the device, select **Yes** and press **OK**.

Removing a paired device

Press **MENU**, select **Connections** and press **OK**.

Select **Connections management**. A list of all Bluetooth devices currently paired to the Infotainment system is displayed.

Notice

The Bluetooth device currently connected to the Infotainment system is indicated by .

Select the desired device and press **OK** to confirm.

To remove the paired device, select **Delete connection** and press **OK**.

Operation

As soon as a Bluetooth connection has been set up between your mobile phone and the Infotainment system, you can also operate many functions of your mobile phone via the Infotainment system.

Via the Infotainment system, you can, e.g. set up a connection to the telephone numbers stored in your mobile phone or change the telephone numbers.

After the setup of a connection between the mobile phone and the Infotainment system, mobile phone data is transmitted to the Infotainment system. This can take several minutes depending on the phone model. During this period, operation of the mobile phone is possible via the Infotainment system only to a limited extent.

Notice

Not every mobile phone fully supports the phone function. Therefore, deviations from the range of functions described below are possible.

Initiating a phone call**Entering a number manually**

Press **MENU**, select **Telephone** and then select **Call**.

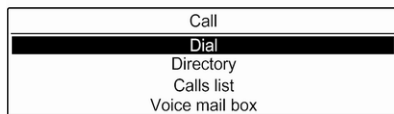

Select **Dial**.

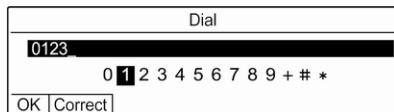

Enter the desired number: Select the desired digits and confirm each digit with **OK**.

To start dialling, select **OK** on the display.

Using the phone book

The phone book contains contact names and numbers.

Press **MENU** and then select **Telephone**.

Select **Call** and then select **Directory**.

To start dialling, scroll through the list and select the desired entry name.

Using the call list

All incoming, outgoing, or missed calls are registered in the call list.

Press **MENU** and then select **Telephone**.

Select **Call** and then select **Calls list**.

To start dialling, scroll through the list and select the desired entry.

Sending contacts from a mobile device to the Infotainment system

With certain telephones connected by Bluetooth, you can send a contact to the directory of the Infotainment system. Contacts imported this way are saved in a permanent directory visible to all, irrespective of the telephone connect.

To enter this directory, press **MENU** and then select **Telephone**.

Select **Directory management**.

The menu for this directory is not accessible if it is empty.

Putting incoming calls automatically on hold

For safety reasons the Infotainment system can put all incoming calls on hold by default.

To activate this function, press **MENU** and then select **Telephone**.

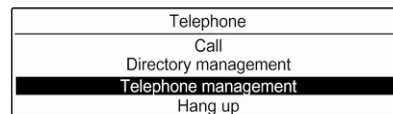

Select **Telephone management** and then select **Telephone parameters**.

To activate the **Automatic on hold** function, press **OK**.

Incoming phone call

If an audio mode, e.g. the radio mode, is active at the time of an incoming call, the relating audio source will be muted and stay muted until the call ends.

To answer the call, select **Yes** in the message shown in the display.

To reject the call, select **No** in the message shown in the display or press and hold ✓ on the steering wheel.

To put an incoming call on hold, select **On hold** in the message shown in the display.

Second incoming phone call

If a second phone call comes in during an ongoing call, a message is displayed.

To answer the second call and end the ongoing call: select **Yes** in the message shown in the display.

To reject the second call and continue the ongoing call: select **No** in the message shown in the display.

Functions during a phone call

During an ongoing phone call, you can use the functions of the contextual menu.

Press **OK** to open the contextual menu.

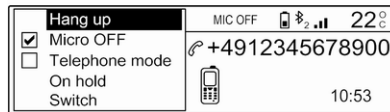

To end the call, select **Hang up**.

To switch off the microphone, activate **Micro OFF**. To switch the microphone on, deselect **Micro OFF**.

To transfer the call to the telephone (for example to leave the vehicle while continuing the conversation), activate **Telephone mode**. To transfer the call to the Infotainment system, deselect **Telephone mode**.

To put the call on hold, select **On hold** during an ongoing call. If a call has been put on hold, the menu item **On hold** changes to **Resume**. To return to a call put on hold, select **Resume**.

To switch between two calls, select **Switch**.

Mobile phones and CB radio equipment

Installation instructions and operating guidelines

The vehicle specific installation instructions and the operating guidelines of the mobile phone and handsfree manufacturer must be observed when installing and operating a mobile telephone. Failure to do so could invalidate the vehicle type approval (EU directive 95/54/EC).

Recommendations for fault-free operation:

- Professionally installed exterior antenna to obtain the maximum range possible.
- Maximum transmission power 10 W.
- Installation of the phone in a suitable spot, consider relevant Note in the Owner's Manual, section **Airbag system**.

Seek advice on predetermined installation points for the external antenna or equipment holder and ways of using devices with a transmission power exceeding 10 W.

Use of a handsfree attachment without external antenna with mobile telephone standards GSM 900/1800/1900 and UMTS is only permitted if the maximum transmission power of the mobile telephone is 2 W for GSM 900 or 1 W for the other types.

For reasons of safety, do not use the phone while driving. Even use of a handsfree set can be a distraction while driving.

Warning

Operation of radio equipment and mobile telephones which fail to meet above mentioned mobile telephone standards is only permitted using an antenna located outside of the vehicle.

Caution

Mobile telephones and radio equipment may lead to malfunctions in the vehicle electronics when operated inside the vehicle with no exterior antenna, unless the above mentioned regulations are observed.

Index

A

- Activating Bluetooth music..... 114
- Activating the Infotainment system..... 102
- Activating the radio..... 108
- Activating the USB function..... 112
- Adjust time and date..... 106
- Automatic volume adjustment... 105
- Auto volume..... 105

B

- Balance..... 105
- Basic operation..... 104
- Bass..... 105
- Blocking out traffic announcements..... 109
- Bluetooth
 - Bluetooth connection..... 118
 - Bluetooth music..... 114
 - Phone..... 119
- Bluetooth connection..... 118
- Bluetooth music
 - Activating..... 114
 - General information..... 114
 - Operation..... 114
 - Prerequisites..... 114

C

- Call
 - Functions during a call..... 119
 - Incoming call..... 119
 - Initiating a phone call..... 119
- Call lists..... 119
- Change display language..... 106
- Control elements
 - Infotainment system..... 99
 - Phone..... 117
 - Steering wheel..... 99
- Control elements overview..... 99

D

- DAB..... 110
- Date
 - adjust..... 106
- Digital audio broadcasting..... 110
- Display
 - activate automatic scrolling.... 106
 - adjust brightness..... 106
 - adjust units for temperature and fuel consumption..... 106
 - change language..... 106
- Distribution..... 105
- Dynamic audio adaption..... 110

E

- Equaliser..... 105

- F**
 Factory default settings..... 106
- G**
 General information... 112, 114, 116, 117
 Bluetooth music..... 114
 Infotainment system..... 98
 Phone..... 117
 USB port..... 112
- I**
 Infotainment control panel..... 99
- M**
 Menu operation..... 104
 Mobile phones and CB radio equipment 121
 Mute..... 102
- O**
 Operation..... 114, 119
 Bluetooth music..... 114
 Infotainment system..... 102
 Menu..... 104
 Phone..... 119
 Radio..... 108
 USB port..... 112
- P**
 Personal settings..... 106
 Phone
 Activating..... 119
 Bluetooth..... 117
 Bluetooth connection..... 118
 Call lists..... 119
 Control elements..... 117
 Dialling a number..... 119
 Functions during a call..... 119
 General information..... 117
 Important information..... 117
 Incoming call..... 119
 Phone book..... 119
 Selecting the ring tone..... 119
 Phone book..... 119
 Playing saved audio files..... 112
- R**
 Radio
 Activating..... 108
 Band selection..... 110
 Configuring DAB..... 110
 Digital audio broadcasting (DAB)..... 110
 Dynamic audio adaption..... 110
 Radio data system (RDS)..... 109
 Radio traffic service..... 109
 Selecting the waveband..... 108
 Station search..... 108
- Station tuning..... 108
 Traffic announcements..... 109
 Usage..... 108
 Radio data system 109
 Radio traffic service..... 109
 RDS..... 109
 Ring tone
 Selecting the ring tone..... 119
- S**
 Selecting the waveband..... 108
 Sound..... 105
 Speech recognition..... 116
 Station search..... 108
 Switching the Infotainment system on..... 102
 Switching the radio on..... 108
 System settings..... 106
- T**
 Theft-deterrent feature 98
 Time
 adjust..... 106
 Tone and volume settings..... 105
 Traffic announcements..... 109
 Treble..... 105
- U**
 Update software..... 106
 Usage..... 102, 108, 116
 Bluetooth music..... 114

Infotainment system.....	102
Menu.....	104
Phone.....	119
Radio.....	108
USB port.....	112
USB menu.....	112
USB port	
Activation.....	112
Connecting the USB device....	112
General information.....	112
Important information.....	112
Operation.....	112
Removing the USB device.....	112
USB menu.....	112
V	
Voice recognition.....	116
Volume	
Mute function.....	102
Setting the volume.....	102

Copyright by Vauxhall Motors Ltd.

The information contained in this publication is effective as of the date indicated below. Vauxhall Motors Ltd. reserves the right to make changes to the technical specifications, features and design of the vehicles relative to the information contained in this publication, as well as changes to the publication itself.

Edition: February 2020, Vauxhall Motors Ltd.

Printed on chlorine-free bleached paper.

ID-VGDAIRIE2002-en

