Contents

Introduction	2
Radio	24
CD/DVD player	40
AUX input	46
USB port	48
Navigation	53
Voice recognition	84
Phone	89
Index	110

Introduction

General information	2
Theft-deterrent feature	3
Control elements overview	5
Usage	11
Basic operation	12
Tone settings	18
Volume settings	21
Personalisation	23

General information

The Infotainment system provides you with state-of-the-art in-car infotainment.

For the AM, FM and DAB (not CD 300) wavebands the radio is equipped with twelve automatically assignable channel presets.

Furthermore, 36 channels can be allocated manually (waveband-independent).

The integrated audio player will entertain you with audio CDs and MP3/WMA CDs, as well as with MP3/WMA DVDs (only DVD 800).

Furthermore, you can connect external data storage devices, e. g. iPod, MP3 player or USB stick (not CD 300), or a portable CD player to the Infotainment system as further audio sources.

The digital sound processor provides you with several preset equalizer modes for sound optimisation.

The navigation system (only CD 500 / DVD 800) with dynamic route planning will reliably guide you to your

destination, and, if desired, will automatically avoid traffic jams or other traffic problems.

Optionally, the Infotainment system can be operated using controls on the steering wheel and a multifunction unit (only CD 500 / DVD 800) between the front seats.

In addition the Infotainment system can be equipped with a mobile phone portal.

The well-thought-out design of the control elements, the clear displays and a large multifunction knob enable you to control the system easily and intuitively.

Important information on operation and traffic safety

Warning

The Infotainment system has to be used so that the vehicle can be driven safely at all times. If in doubt stop your vehicle and operate the Infotainment system while the vehicle is stationary.

⚠ Warning

The usage of the navigation system (only CD 500 / DVD 800) does not release the driver from the responsibility for a correct, vigilant attitude in road traffic. The related traffic regulations must always be followed.

Only make entries (e. g. addresses) with the vehicle stationary.

If a navigation instruction contradicts traffic regulations, the traffic regulations always apply.

⚠ Warning

In some areas one-way streets and other roads and entrances (e. g. pedestrian zones) that you are not allowed to turn into are not marked on the map. In such areas the Infotainment system will issue a warning that must be accepted. Here you must pay particular attention to one-way streets, roads and entrances that you are not allowed to drive into.

Radio reception

Radio reception may be disrupted by static, noise, distortion or loss of reception due to

- changes in distance from the transmitter,
- multi-path reception due to reflection,
- shadowing.

Theft-deterrent feature

The Infotainment system is equipped with an electronic security system for the purpose of theft deterrent.

The Infotainment system therefore functions only in your vehicle and is worthless for a thief.

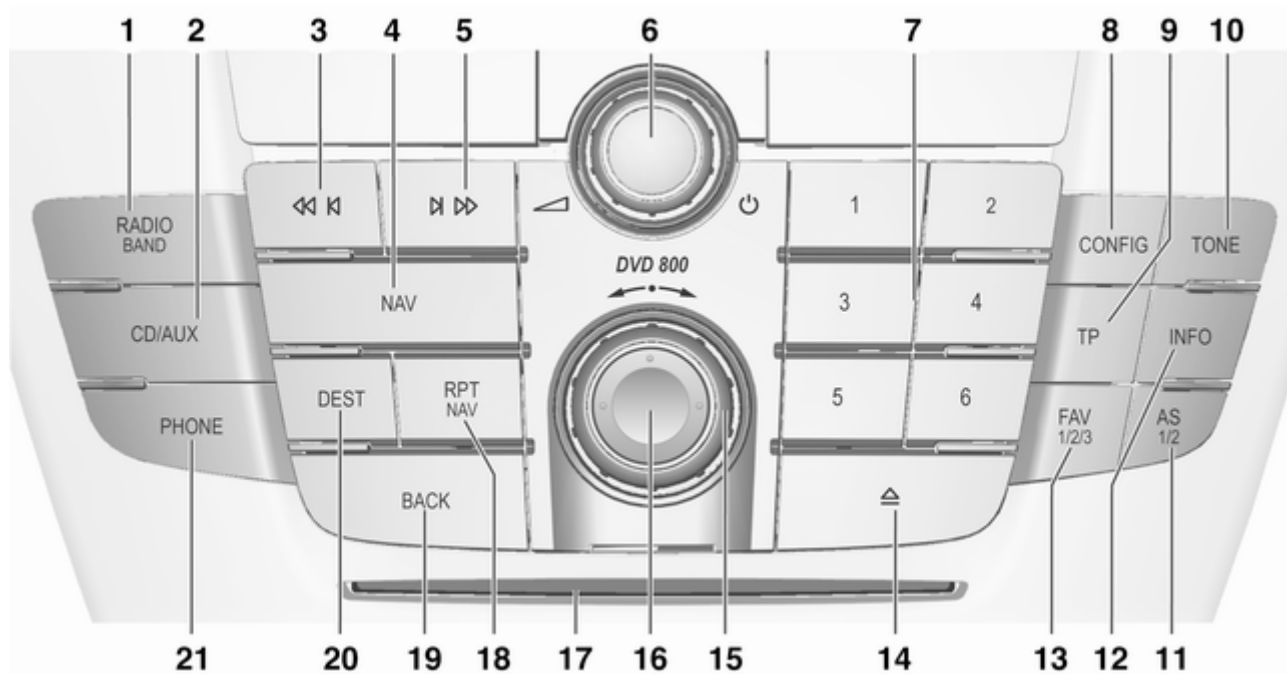

Control elements overview

Instrument panel CD 500 / DVD 800

1	RADIO (BAND) 24 Activate radio or change waveband 24	7	Radio station buttons 1...6 ... 25 Long press: save station 25 Short press: select station ... 25	15	Multifunction knob 12 Central control for selection and navigation in menus 12
2	CD/AUX 46 Start CD/MP3/WMA replay or change audio source 46	8	CONFIG 21 System settings 21	16	Eight-way switch 55 Navigation: move display window in map view 55
3	Search backward 24 Radio: search backward 24 CD/MP3/WMA: skip track backward 42	9	TP 33 Activate or deactivate radio traffic service 33	17	CD/DVD slot 42
4	NAV 55 Press once: Display map 55 Press twice: Navigation menu 55	10	TONE 18 Tone settings 18	18	RPT (NAV) 78 Repeat last navigation message 78
5	Search forward 24 Radio: search forward 24 CD/MP3/WMA: skip track forward 42	11	AS (1/2) 25 Automatic memory levels (preset radio stations) 25 Short press: select autostore list 25 Long press: save stations automatically 25	19	BACK 12 Menu: one level back 12 Input: delete last character or entire entry 12
6	☉ knob 11 Press: switch on/off Infotainment system 11 Turn: adjust volume 11	12	INFO 24 Additional, situation-dependent information 24	20	DEST 55 Navigation destination entry 55
		13	FAV (1/2/3) 26 Favourite lists (preset radio stations) 26	21	PHONE 84 Open telephone main menu 84 Activate/deactivate mute 11
		14	CD/DVD ejection 42		

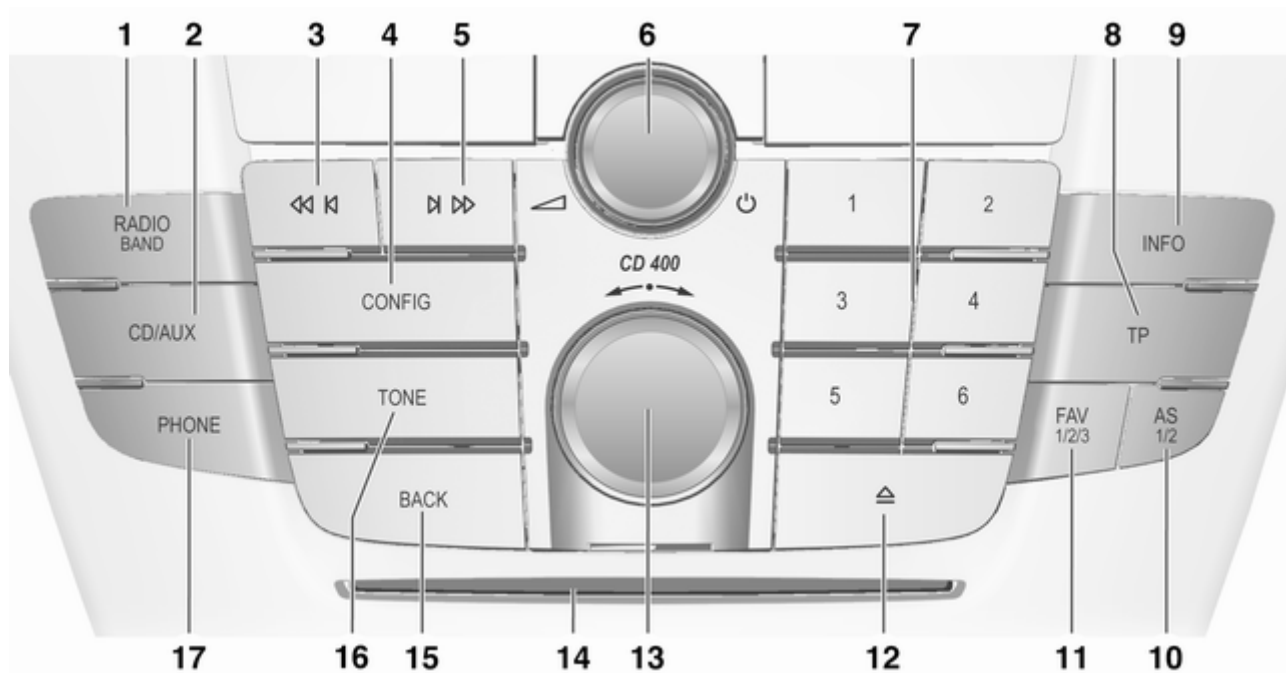

Instrument panel CD 400

- | | | |
|--|--|---|
| <p>1 RADIO (BAND) 24
 Activate radio or change waveband 24</p> <p>2 CD/AUX 46
 Start CD/MP3/WMA replay or change audio source 46</p> <p>3 Search backward 24
 Radio: search backward 24
 CD/MP3/WMA: skip track backward 42</p> <p>4 CONFIG 21
 Open settings menu 21</p> <p>5 Search forward 24
 Radio: search forward 24
 CD/MP3/WMA: skip track forward 42</p> <p>6 \odot knob 11
 Press: switch on/off 11
 Infotainment system 11
 Turn: adjust volume 11</p> <p>7 Radio station buttons 1...6 ... 25
 Long press: save station 25
 Short press: select station ... 25</p> | <p>8 TP 33
 Activate or deactivate radio traffic service 33
 If Infotainment system switched off: display time and date 33</p> <p>9 INFO 24
 Radio: Information about the current station 24
 CD/MP3: Information about the current title 42</p> <p>10 AS (1/2) 25
 Automatic memory levels (preset radio stations) 25
 Short press: select autostore list 25
 Long press: save stations automatically 25</p> <p>11 FAV (1/2/3) 26
 Lists of favourites (preset radio stations) 26</p> <p>12 CD ejection 42</p> | <p>13 Multifunction knob 12
 Turn: mark menu options or set numeric values 12
 Press: select/activate the marked option; confirm set value; switch function on/off 12</p> <p>14 CD slot 42</p> <p>15 BACK 12
 Menu: one level back 12
 Input: delete last character or entire entry 12</p> <p>16 TONE 18
 Tone settings 18</p> <p>17 PHONE 84
 Open telephone main menu 84
 Activate mute 11</p> |
|--|--|---|

Instrument panel CD 300

- | | | |
|--|---|---|
| <p>1 RADIO (BAND) 24
 Activate radio or change waveband 24</p> <p>2 CD/AUX 46
 Start CD/MP3/WMA replay or change audio source (AUX = external audio source) 46</p> <p>3 MP3: folder level higher 42</p> <p>4 Search backward 24
 Radio: search backward 24
 CD/MP3/WMA: skip track backward 42</p> <p>5 Search forward 24
 Radio: search forward 24
 CD/MP3/WMA: skip track forward 42</p> <p>6 MP3: folder level lower 42</p> <p>7 \odot knob 11
 Press: switch on/off the Infotainment system 11
 Turn: adjust volume 11</p> <p>8 Radio station buttons 1...6 ... 25
 Long press: save station 25
 Short press: select station ... 25</p> | <p>9 TP 33
 Activate or deactivate radio traffic service 33
 If Infotainment system switched off: display time and date 33</p> <p>10 INFO 24
 Radio: Information about the current station 24
 CD/MP3: Information about the current title 42</p> <p>11 AS (1/2) 25
 Automatic memory levels (preset radio stations) 25
 Short press: select autostore list 25
 Long press: save stations automatically 25</p> <p>12 FAV (1/2/3) 26
 Lists of favourites (preset radio stations) 26</p> <p>13 CD ejection 42</p> | <p>14 Multifunction knob 12
 Turn: mark menu options or set numeric values 12
 Press: select/activate the marked option; confirm set value; switch function on/off 12</p> <p>15 CD slot 42</p> <p>16 CONFIG 21
 Open settings menu 21</p> <p>17 BACK 12
 Menu: one level back 12
 Input: delete last character or entire entry 12</p> <p>18 TONE 18
 Tone settings 18</p> <p>19 PHONE 84
 Open telephone main menu 84
 Activate mute 11</p> |
|--|---|---|

Steering wheel audio controls

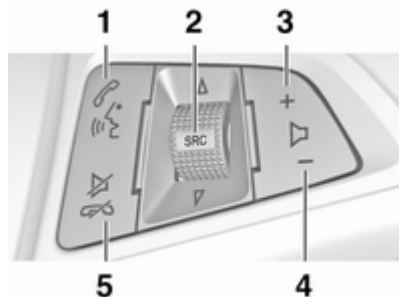

- 1 Short press: take phone call 89
or dial number in call list 102
or activate speech recognition 102
Long press: show call list ... 102

- 2 SRC (Source) 11
Press: select audio source ... 11
If radio active: turn upwards/downwards to select next/previous preset radio station 24
If CD player active: turn upwards/downwards to select next/previous CD/MP3/WMA track 42
If Phone portal active: turn upwards/downwards to select next/previous entry in call list 102
If Phone portal active and calls waiting: turn upwards/downwards to switch between calls 102
- 3 Increase volume 11
- 4 Reduce volume 11
- 5 Short press: end/decline call 102
or close call list 102
or deactivate speech recognition 102
or activate/deactivate mute .. 11

Multifunction unit

(only CD 500 / DVD 800)

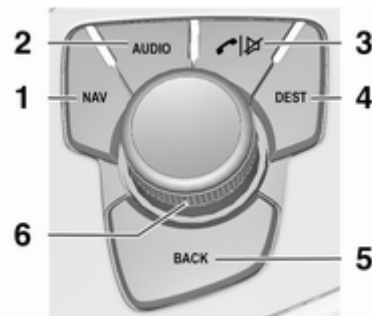

- 1 NAV 55
Press once: Display map 55
Press twice: Navigation menu 55
- 2 AUDIO 4
Change audio source 46
- 3 Take/end call 102
Activate or deactivate mute . 11
- 4 DEST Navigation destination entry 59

5	BACK	12
	Menu: one level back	12
	Input: delete last character or entire entry	12
6	Multifunction knob	12
	Central control for selection and navigation in menus	12

Usage

Control elements

The Infotainment system is operated via function buttons, multifunction knobs and menus that are shown on the display.

Inputs are made optionally via:

- the central control unit in the instrument panel ↪ 4
- controls on the steering wheel ↪ 4
- the multifunction unit (only CD 500 / DVD 800) between the front seats ↪ 4

Switching the Infotainment system on or off

Press the \odot knob briefly. After switching on the last selected Infotainment source is active.

Automatic switch-off

If the Infotainment system has been switched on using the \odot knob when the ignition was switched off, it will switch off again automatically 30 minutes after the last user input.

Setting the volume

Turn the \odot knob. The current setting is shown on the display.

When the Infotainment system is switched on, the last selected volume is set, if that volume is lower than the maximum start up volume.

The following can be set separately:

- the maximum start up volume ↪ 21
- the volume of the traffic announcements ↪ 21
- the volume of the navigation messages (only CD 500 / DVD 800) ↪ 55

Speed compensated volume

When speed compensated volume is activated ↪ 21 the volume is adapted automatically to make up for the road and wind noise as you drive.

Mute

Press the **PHONE** button (if Phone portal available: press for a few seconds) to mute the audio sources.

To cancel mute again: turn the  knob or press the **PHONE** button again (if Phone portal available: press for a few seconds).

Volume limitation at high temperatures

(only CD 300 / CD 400)

At very high temperatures inside the vehicle the Infotainment system limits the maximum adjustable volume. If necessary the volume is decreased automatically.

Modes of operation

Radio

Press the **RADIO** button to open the radio main menu or to change between the different wavebands.

Press the multifunction knob to open a submenu with options for station selection.

Detailed description of the radio functions ⇨ 24.

Audio players

Press **CD/AUX** button to open the CD, USB, iPod or AUX menu (if available) or to swap between these menus.

Press the multifunction knob to open a submenu with options for track selection.

CD 500 / DVD 800

Detailed description of:

- CD/DVD player functions ⇨ 42
- AUX input functions ⇨ 46
- USB port functions ⇨ 48

CD 300 / CD 400

Detailed description of:

- CD player functions ⇨ 42
- AUX input functions ⇨ 46
- USB port functions (not with CD 300) ⇨ 48

Navigation

(only CD 500 / DVD 800)

Press **NAV** button twice to open the Navigation menu.

Detailed description of the navigation system functions ⇨ 55.

Phone

(if Phone portal available)

Press the **PHONE** button to open the telephone menu.

Press the multifunction knob to open a submenu with options for the input or selection of numbers.

Detailed description of the mobile phone portal functions ⇨ 89.

Basic operation

Multifunction knob

The multifunction knob is the central control element for the menus.

Turn the multifunction knob:

- to mark a menu option
- CD 300: to display a menu option
- to set a numeric value

Press the multifunction knob (CD 500 / DVD 800: press the outer ring):

- to select or activate the marked option
- CD 300: to select or activate the option displayed

- to confirm a set value
- to switch a system function on/off

BACK button

Press the **BACK** button briefly to:

- exit a menu
- return from a submenu to the next higher menu level
- delete the last character in a character sequence

Press and hold the **BACK** button for a few seconds to delete the entire entry.

Examples of menu operation

CD 500 / DVD 800 Selecting an option

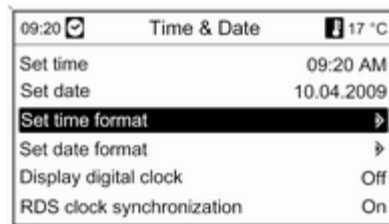

Turn the multifunction knob to move the cursor (= coloured background) to the desired option.

Press the multifunction knob to select the marked option.

Submenus

An arrow on the right-hand edge of the menu indicates that after selection of the option a submenu with further options will be opened.

Activating a setting

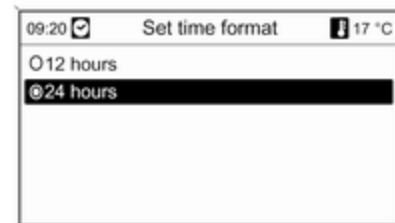

Turn the multifunction knob to mark the desired setting.

Press the multifunction knob to activate the setting.

Setting a value



Turn the multifunction knob to change the current value of the setting.
Press the multifunction knob to confirm the set value.

Switching a function on or off

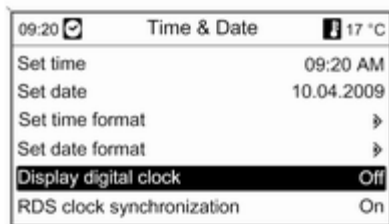

Turn the multifunction knob to mark the function to be switched on or off.
Press the multifunction knob to switch between the settings **On** and **Off**.

Entering a character sequence

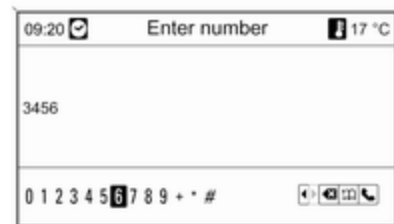

To enter character sequences, e. g. telephone numbers or road names:
Turn the multifunction knob to select the desired character.
The last character in the character sequence can be deleted using the **BACK** button. Pressing and holding the **BACK** button deletes the entire entry.
Press the multifunction knob to confirm the selected character.

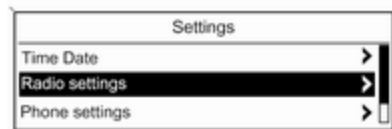
CD 400**Selecting an option**

Turn the multifunction knob to move the cursor (= coloured background) to the desired option.

Press the multifunction knob to select the marked option.

Submenus

An arrow on the right-hand edge of the menu indicates that after selection of the option a submenu with further options will be opened.

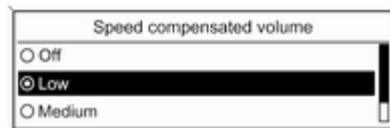
Activating a setting

Turn the multifunction knob to mark the desired setting.

Press the multifunction knob to activate the setting.

Setting a value

Turn the multifunction knob to change the current value of the setting.

Press the multifunction knob to confirm the set value.

Switching a function on or off

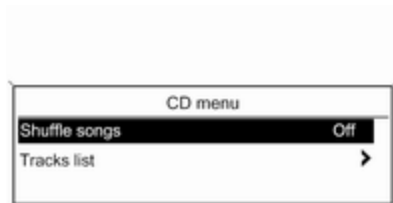

Turn the multifunction knob to mark the function to be switched on or off. Press the multifunction knob to switch between the settings **On** and **Off**.

Entering a character sequence

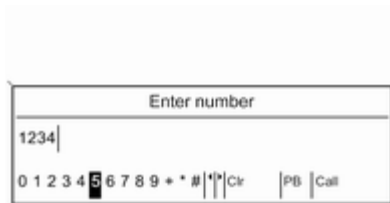

For the input of character sequences, e. g. telephone numbers:

Turn the multifunction knob to select the desired character.

Press the multifunction knob to confirm the selected character.

Using the **BACK** button the last character in the character sequence can be deleted.

CD 300

Menu elements and symbols

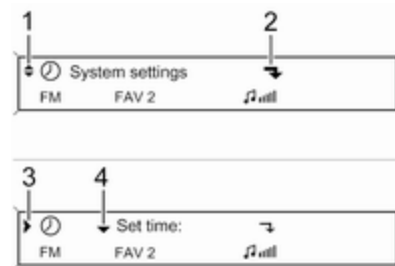

The down arrow **1** indicates: the top menu level is active. Further options are available in the active menu.

Turn the multifunction knob to display the other options in the active menu.

The angled arrow **2** indicates: a submenu with further options is available.

Press the multifunction knob to select the option displayed and to open the corresponding submenu.

The arrow pointing to the right **3** indicates: the first submenu level is active (two arrows = second submenu level active).

The down arrow **4** indicates: further options are available in the active submenu.

Activating a setting



Press the multifunction knob to open the corresponding settings menu.

Turn the multifunction knob to display the desired setting.

Press the multifunction knob to activate the setting.

Setting a value

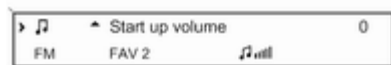

Press the multifunction knob to open the corresponding settings menu.

Turn the multifunction knob to change the current value of the setting.

Press the multifunction knob to confirm the set value.

Switching a function on or off



Press the multifunction knob to open the corresponding settings menu.

Turn the multifunction knob to mark the setting **On** or **Off**.

Press the multifunction knob to confirm the marked setting.

Entering a character sequence

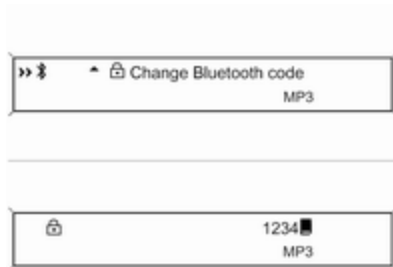

Press the multifunction knob to open the relevant settings menu.

Turn the multifunction knob to change the character at the current cursor position.

Press the multifunction knob to confirm the character displayed.

Using the **BACK** button the last character in the character sequence can be deleted.

Tone settings

CD 500 / DVD 800

In the tone settings menu the tone characteristic can be set differently for each radio waveband and each audio player source.

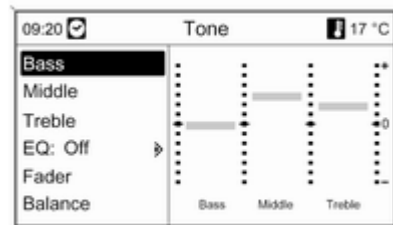

Press the **TONE** button to open the tone menu.

Setting bass, middle and treble

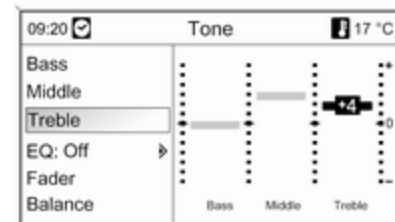

Select **Bass**, **Middle** or **Treble**.

Set the desired value for the option selected.

Setting the volume distribution between front - rear

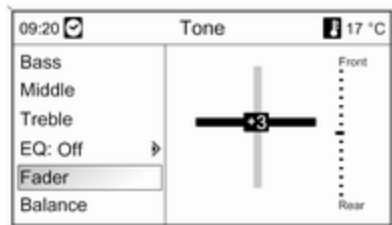

Select **Fader**.
Set the desired value.

Setting the volume distribution between right - left

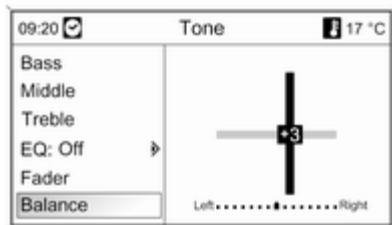

Select **Balance**.
Set the desired value.

Setting an individual setting to "0" or "Off"

Select the desired option and press and hold the multifunction knob for a few seconds.

Setting all settings to "0" or "Off"

Press and hold the **TONE** button for a few seconds.

Optimising the tone for the style of music

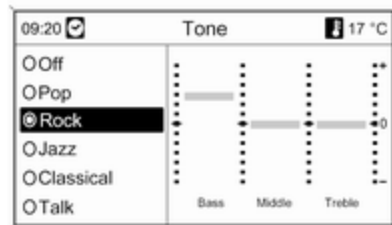

Select **EQ** (Equalizer).
The displayed options offer optimised bass, middle and treble presets for the relevant style of music.
Select the required option.

CD 300 / CD 400

In the tone settings menu the tone characteristics can be set differently for each radio waveband and each audio player source.

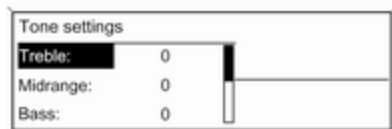

Press the **TONE** button to open the tone menu.

Setting bass, middle and treble



Select **Bass:**, **Midrange:** or **Treble:**.

Set the desired value for the selected option.

Setting the volume distribution between front - rear

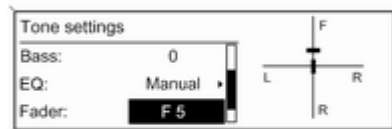

Select **Fader:**.

Set the desired value.

Setting the volume distribution between right - left

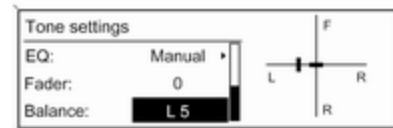

Select **Balance:**.

Set the desired value.

Setting an individual setting to "0" or "Off"

Select the desired option and press and hold the multifunction knob for a few seconds.

Setting all settings to "0" or "Off"

Press and hold the **TONE** button for a few seconds.

Optimizing the tone for the style of music

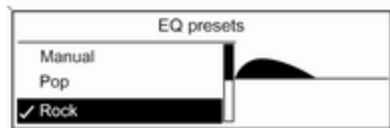

Select **EQ**: (Equalizer).

The displayed options offer optimized bass, middle and treble presettings for the relevant style of music.

Select the desired option.

Volume settings

CD 500 / DVD 800

Maximum startup volume

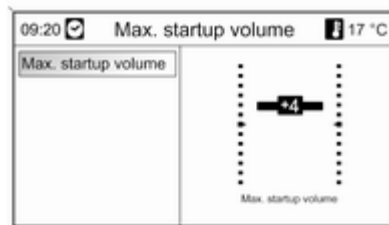

Press the **CONFIG** button to open the system settings menu.

Select **Radio settings** and then **Maximum startup volume**.

Set the desired value.

Speed dependent volume

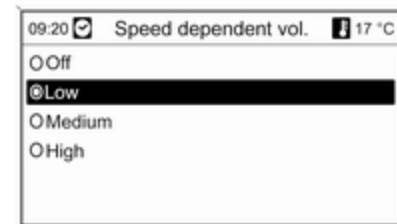

Press the **CONFIG** button to open the system settings menu.

Select **Radio settings** and then **Speed dependent volume**.

Speed dependent volume can be deactivated or the degree of volume adaptation can be selected in the menu displayed.

Select the required option.

Volume of the traffic announcements (TA)

The volume of the traffic announcements can be increased or reduced proportionately to the normal audio volume.

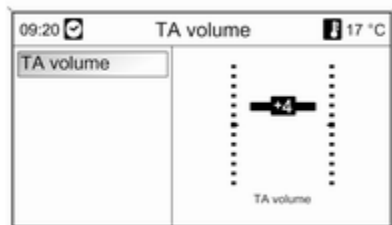

Press the **CONFIG** button to open the system settings menu.

Select **Radio settings**, **RDS options** and **TA volume**.

Set the desired value.

CD 300 / CD 400

Maximum startup volume

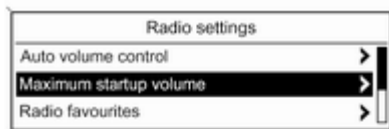

Press the **CONFIG** button to open the system settings menu.

Select **Radio settings** and then **Maximum startup volume**.

CD 300: select **Audio settings** and then **Start up volume**.

Set the desired value.

Speed compensated volume



Press the **CONFIG** button to open the system settings menu.

Select **Radio settings** and then **Speed compensated volume**.

CD 300: select **Audio settings** and then **Speed compensated volume**.

Speed compensated volume can be deactivated or the degree of volume adaptation can be selected in the menu displayed.

Select the desired option.

Volume of the traffic announcements (TA)

The volume of the traffic announcements can be increased or reduced proportionately to the normal audio volume.

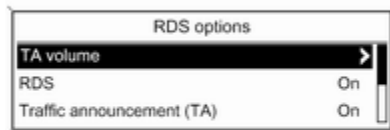

Press the **CONFIG** button to open the system settings menu.

Select **Radio settings**, **RDS options** and **TA volume**.

CD 300: select **Audio settings**, **RDS options** and **TA volume**.

Set the desired value for the volume increase or reduction.

Personalisation

(only CD 400)

Various Infotainment system settings can be separately memorised for each vehicle key (driver) of the car.

Memorised settings

By removing the vehicle key from the ignition switch the following settings are automatically saved for the key being used:

- last volume settings; one volume level for all non-phone audio sources (radio, CD player, AUX, USB) and one for phone audio (if phone portal available)
- all radio station presets
- all tone settings; each of these settings are separately saved for each of the following audio sources (if available): AM, FM, DAB, CD player, AUX, USB
- last active audio source
- last active radio station (separately for each waveband)
- last active display mode

- last position in Audio/MP3 CD including track number and folder
- state of shuffle songs setting (CD player)
- state of TP (Traffic Programme) setting
- cursor position for each menu on the display

Activating/deactivating personalization

Press the **CONFIG** button to open the system settings menu.

Select **Vehicle settings** and then **Comfort settings**.

Set **Personalization by driver** to **On** or **Off**.

Radio

Usage	24
Station search	24
Autostore lists	25
Favourite lists	26
Waveband menus	28
Radio data system (RDS)	33
Digital audio broadcasting	37

Usage

Control buttons

The most important buttons for control of the radio are as follows:

- **RADIO**: Activate radio
- **◀ K N ▶**: Station search
- **AS**: Autostore lists
- **FAV**: Favourite lists
- **1...6**: Preset buttons
- **TP**: Radio traffic service ⇨ 33

Activating the radio

Press the **RADIO** button to open the radio main menu.

The station last played will be received.

Selecting the waveband

Press the **RADIO** button once or several times to select the desired waveband.

The station last played in that waveband will be received.

Station search

Automatic station search

Briefly press the button **◀ K** or **N ▶** to play the next station in the station memory.

Manual station search

CD 500 / DVD 800

Press **◀ K** or **N ▶** button and keep pressed. Release button when the required frequency has almost been reached on the frequency display.

A search is made for the next station that can be received and it is played automatically.

CD 300 / CD 400

Press the button **◀ K** or **N ▶** for a few seconds to start a search for the next receivable station in the current waveband.

When the required frequency has been reached the station is played automatically.

Notice

Manual station search: If the radio does not find a station, it switches automatically to a more sensitive search level. If it still does not find a station, the frequency that was last active is set again.

Notice

FM waveband: when the RDS function is activated, only RDS stations ↻ 33 are searched for, and when the radio traffic service (TP) is activated, only traffic service stations ↻ 33 are searched for.

Manual station tuning**FM waveband**

Only CD 500 / DVD 800: press the multifunction knob to open the FM menu and select **Manual tuning FM**.

Turn the multifunction knob and set the optimal reception frequency on the popup frequency display.

AM waveband

Turn the multifunction knob and set the optimal reception frequency on the popup frequency display.

DAB waveband

(not available for CD 300)

Press the multifunction knob to open the DAB menu and select **DAB manual tuning**.

Turn the multifunction knob and set the required reception frequency on the popup frequency display.

Autostore lists

The stations that can be received best in a waveband can be searched for and stored automatically via the autostore function.

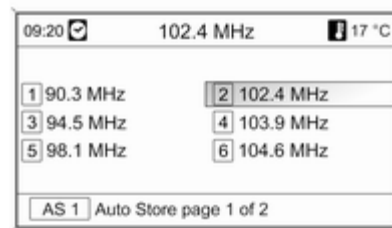
CD 500 / DVD 800:**Notice**

The currently received station is highlighted.

CD 400:

AS-Stations		FM AS1
1 FM 89.0	2 FM 92.1	
3 FM 93.8	4 FM 95.6	
5 FM 95.9	6 FM 97.2	

Notice

The currently received station is marked by 📻.

Each waveband has 2 autostore lists (**AS 1**, **AS 2**), in each of which 6 stations can be stored.

Automatic station storing

Keep the **AS** button pressed until an autostore message is displayed. The 12 strongest stations in the current waveband will be stored in the 2 autostore lists.

To abort the autostore procedure, press the multifunction knob.

Storing stations manually

Stations can also be stored manually in the autostore lists.

Set the station to be stored.

Briefly press the **AS** button to open an autostore list or to switch to another autostore list.

To store the station in a list position: press the corresponding station button 1...6 until a confirmation message is displayed.

Notice

Manually stored stations are overwritten in an automatic station storing process.

Retrieving a station

Briefly press the **AS** button to open an autostore list or to switch to another autostore list.

Briefly press one of the station buttons 1...6, to open the station at the corresponding list position.

Favourite lists

Stations of all wavebands can be stored manually in the favourite lists.

CD 500 / DVD 800

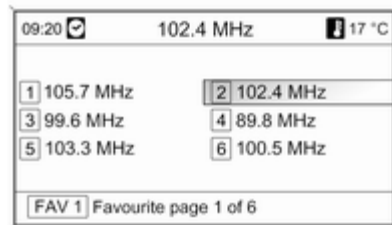

6 stations can be stored in each favourite list. The number of available favourite lists can be set (see below).

Notice

The currently received station is highlighted.

Storing a station

Set the station to be stored.

Briefly press the **FAV** button to open a favourite list or to switch to another favourite list.

To store the station in a list position: press the corresponding station button 1...6 until a confirmation message is displayed.

Retrieving a station

Briefly press the **FAV** button to open a favourite list or to switch to another favourite list. Briefly press one of the station buttons 1...6, to open the station at the related list position.

Defining the number of available favourite lists

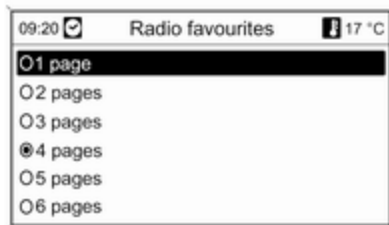

Press **CONFIG** button.

Select **Radio settings** and then **Radio favourites**.

Select the desired number of available favourite lists.

CD 300 / CD 400

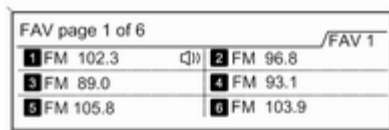

6 stations can be stored in each favourite list. The number of available favourite lists can be set (see below).

CD 300: The number of available favourite lists is not configurable.

Notice

The currently received station is marked by 📡.

Storing a station

Set the station to be stored.

Briefly press the **FAV** button to open a favourite list or to switch to another favourite list.

To store the station in a list position: press the corresponding station button 1...6 until a confirmation message is displayed.

Retrieving a station

Briefly press the **FAV** button to open a favourite list or to switch to another favourite list.

Briefly press one of the station buttons 1...6, to open the station at the related list position.

Defining the number of available favourite lists

(not CD 300)

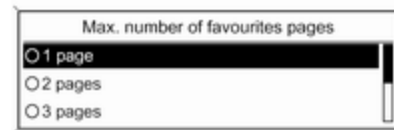

Press the **CONFIG** button.

Select **Radio settings** and then **Radio favourites**.

Select the desired number of available favourite lists.

Waveband menus

Alternative facilities for station selection are available via waveband specific menus.

With the radio main menu active press the multifunction knob to open the relevant waveband menu.

Notice

The following FM specific displays are shown as examples.

CD 500 / DVD 800

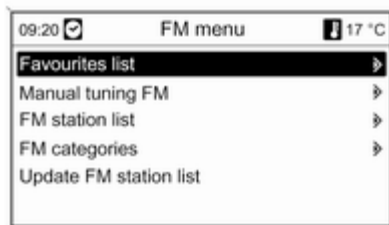

Favourites list

Select **Favourites list**. All stations saved in the favourites lists are displayed.

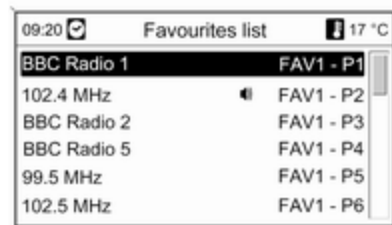

Select the required station.

Notice

The currently received station is marked by .

Manual tuning

Description  **Station search**.

Station lists

AM/FM waveband

Select **AM station list** or **FM station list**.

All receivable AM/FM stations in the current reception area are displayed.

DAB waveband

Turn the multifunction knob.

All receivable DAB stations ⇨ 37 in the current reception area are displayed.

Notice

If no station list has been created beforehand, the Infotainment system performs an automatic station search.



Select the required station.

Notice

The currently received station is marked by 📻.

Updating station lists

If the stations stored in a waveband-specific station list can no longer be received:

Select the corresponding command to update a station list.

A station search is started. Once the search is finished, the station previously selected is played.

To cancel the station search: press multifunction knob.

Notice

If a waveband specific station list is updated the corresponding category list (if available) is also updated.

Important information on updating the station lists

The dual tuner in the Infotainment system continuously updates the station lists in the background. This ensures that, e. g., the station lists always contain the stations that can be received in the local area during a long motorway journey. As the automatic updating takes a certain amount of time, not all stations that can be received may be available at

once in the station list at a sudden change in reception area. In such circumstances the updating of the station lists can be accelerated using the corresponding command for updating a station list.

Category lists

Numerous RDS stations ⇨ 33 broadcast a PTY code, which specifies the type of programme transmitted (e. g. news). Some stations also change the PTY code depending on the content currently being transmitted.

The Infotainment system stores these stations, sorted by programme type, in the corresponding category list.

To search for a programme type determined by station: select the waveband specific category list option.

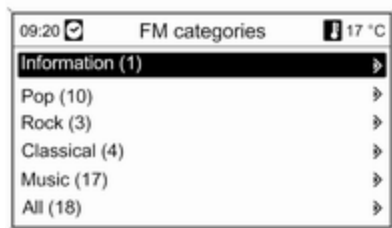

A list of programme types available at the moment is displayed.

Select desired programme type.

A list of stations is displayed that transmit a programme of the selected type.

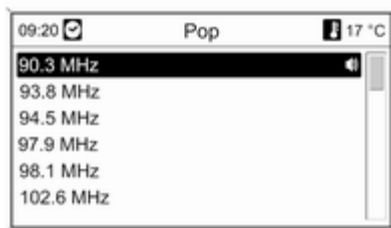

Select the required station.

The category list is also updated when the corresponding waveband specific station list is updated.

Notice

The currently received station is marked by .

DAB announcements

Besides their music programmes numerous DAB stations broadcast various announcement categories.

The currently received DAB service (programme) is interrupted when any announcements of previously activated categories are pending.

Activating announcement categories

Select **DAB announcements** in the DAB menu.

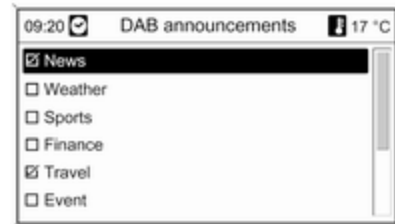

Activate the desired announcement categories.

Several announcement categories can be selected at the same time.

Notice

DAB announcements can only be received if the DAB waveband is activated.

CD 300 / CD 400

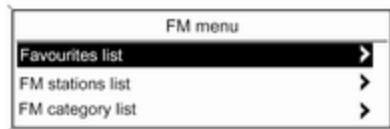
**Favourites list**

Select **Favourites list**. All stations saved in the favourites lists are displayed.

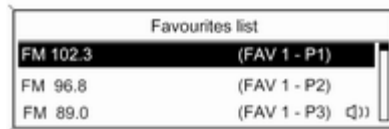

Select the required station.

Notice

The currently received station is marked by .

Stationslists**AM/FM waveband**

Select **AM stations list** or **FM stations list**.

All receivable AM/FM stations in the current reception area are displayed.

DAB waveband

(not available for CD 300)

Turn the multifunction knob.

All receivable DAB stations 37 in the current reception area are displayed.

Notice

If no station list has been created beforehand, the Infotainment system performs an automatic station search.



Select the required station.

Notice

The currently received station is marked by .

Updating stations lists

If the stations stored in a waveband-specific station list can no longer be received:

Select the corresponding command to update a station list.

CD 400: The dual tuner of the Infotainment system continuously updates the FM stations list in the background. No manual update is required.

A station search is started. Once the search is completed the station last received will be played.

To abort the station search, press the multifunction knob.

Notice

If a waveband specific station list is updated the corresponding category list (if available) is also updated.

Category lists

Numerous RDS stations ⇨ 33 broadcast a PTY code, which specifies the type of programme transmitted (e. g. news). Some stations also change the PTY code depending on the content currently being transmitted.

The Infotainment system stores these stations, sorted by programme type, in the corresponding category list.

To search for a programme type determined by station: select the waveband specific category list option.



A list of programme types available at the moment is displayed.

Select the desired programme type.

A list of stations is displayed that transmit a programme of the selected type.



Select the desired station.

CD 300: The next receivable station of the selected type is searched for and is played.

The category list is also updated when the corresponding waveband specific station list is updated.

Notice

The currently received station is marked by 📻.

DAB announcements

Besides their music programmes numerous DAB stations ⇨ 37 broadcast various announcement categories.

The currently received DAB service (programme) is interrupted when any announcements of previously activated categories are pending.

Activating announcement categories

Select **DAB announcements** in the DAB menu.

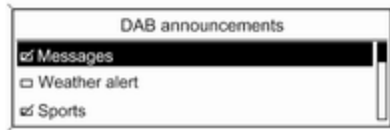

Activate the desired announcement categories.

Several announcement categories can be selected at the same time.

Notice

DAB announcements can only be received if the DAB waveband is activated.

Radio data system (RDS)

RDS is a service of FM stations that considerably facilitates the finding of the desired station and its fault-free reception.

Advantages of RDS

- On the display the programme name of the set station appears instead of its frequency.
- On station search the Infotainment system tunes in to RDS stations only.
- The Infotainment system always tunes into the best receivable broadcasting frequency of the set station by means of AF (Alternative Frequency).
- Depending on the station that is received the Infotainment system displays radio text that can contain, for example, information about the current programme.

CD 500 / DVD 800



Configuring RDS

To open the menu for the RDS configuration:

Press the **CONFIG** button.

Select **Radio settings** and then **RDS options**.

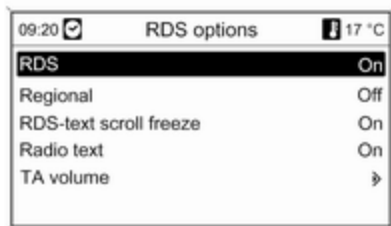

Switching RDS on and off

Set **RDS** to **On** or **Off**.

Switching regionalization on and off
(RDS must be activated for regionalization.)

At certain times some RDS stations broadcast regionally different programmes on different frequencies.

Set **Regional** to **On** or **Off**.

If regionalization is switched on, only alternative frequencies (AF) with the same regional programmes are selected.

If regionalization is switched off, alternative frequencies of the stations are selected without regard to regional programmes.

RDS scrolling text

Some RDS stations use the lines for indicating the name of the programme to also indicate additional information. During this process the programme name is hidden.

To prevent additional information being displayed:

Set **RDS-text scroll freeze** to **On**.

Radio text

If RDS and reception of an RDS station are activated, information about the programme that is currently receivable and about the music track being played at the moment are displayed below the programme name.

To show or hide the information:

Set **Radio text** to **On** or **Off**.

TA volume

The volume of the traffic announcements (TA) can be preset ↵ 21.

Radio traffic service

(TP = Traffic Programme)

Radio traffic service stations are RDS stations that broadcast traffic news.

Switching the radio traffic service on and off

To switch the traffic announcement standby facility of the Infotainment system on and off:

Press the **TP** button.

- If the radio traffic service is switched on, [] is indicated on the display in black (grey if radio traffic service is switched off).
- Only radio traffic service stations are received.
- If the current station is not a radio traffic service station, a search is started automatically for the next radio traffic service station.
- If a radio traffic service station has been found, [TP] is indicated on the display in black. If no radio traffic service stations are found, TP is displayed in grey.
- Traffic announcements are played at the preset TA volume ↵ 21.

- If the radio traffic service is switched on, CD/MP3 replay is interrupted for the duration of the traffic announcement.

Listening to traffic announcements only

Switch on the radio traffic service and completely turn down the volume of the Infotainment system.

Blocking out traffic announcements

To block out a traffic announcement, e. g. during CD/MP3 replay:

Press **TP** button or the multifunction knob to confirm the cancel message on the display.

The traffic announcement is aborted, but the radio traffic service remains switched on.

EON (Enhanced Other Networks)

With EON you can listen to radio traffic announcements even if the station you have set does not broadcast its own radio traffic service. If such a station is set, it is displayed in black as for radio traffic service stations **TP**.

CD 300 / CD 400



Configuring RDS

To open the menu for the RDS configuration:

Press the **CONFIG** button.

Select **Radio settings** and then **RDS options**.

CD 300: Select **Audio settings** and then **RDS options**.



TA volume

The volume of the traffic announcements (TA) can be preset ⇨ 21.

Switching RDS on and off

Set the option **RDS** to **On** or **Off**.

Traffic announcement (TA)

To switch the TA function on or off permanently:

Set the option **Traffic announcement (TA)** to **On** or **Off**.

Switching regionalization on and off (RDS must be activated for regionalization.)

At certain times some RDS stations broadcast regionally different programmes on different frequencies.

Set the option **Regional (REG)** to **On** or **Off**.

If regionalization is switched on, only alternative frequencies (AF) with the same regional programmes are selected.

If regionalization is switched off, alternative frequencies of the stations are selected without regard to regional programmes.

RDS-scrolling text

Some RDS stations hide the programme name in the display line in order to display additional information.

To prevent additional information being displayed:

Set **RDS-Text scroll freeze** to **On**.

Radio text:

If RDS and reception of an RDS station are activated, information about the programme that is currently receivable and about the music track

being played at the moment are displayed below the programme name.

To show or hide the information:

Set the option **Radio text:** to **On** or **Off**.

Radio traffic service

(TP = Traffic Programme)

Radio traffic service stations are RDS stations that broadcast traffic news.

Switching the radio traffic service on and off

To switch the traffic announcement standby facility of the Infotainment system on and off:

Press the **TP** button.

- If the radio traffic service is switched on, [] is displayed in the radio main menu.
- Only radio traffic service stations are received.
- If the current station is not a radio traffic service station, a search is started automatically for the next radio traffic service station.

- If a radio traffic service station has been found, [TP] is displayed in the radio main menu.
- Traffic announcements are played at the preset TA volume ⇨ 21.
- If the radio traffic service is switched on, CD/MP3 replay is interrupted for the duration of the traffic announcement.

Listening to traffic announcements only

Switch on the radio traffic service and completely turn down the volume of the Infotainment system.

Blocking out traffic announcements

To block out a traffic announcement, e. g. during CD/MP3 replay:

Press **TP** button or the multifunction knob to confirm the cancel message on the display.

The traffic announcement is aborted, but the radio traffic service remains switched on.

EON (Enhanced Other Networks)

With EON you can listen to radio traffic announcements even if the station you have set does not broadcast its own radio traffic service. If such a station is set, it is displayed in black as for radio traffic service stations TP.

Digital audio broadcasting

(not available for CD 300)

Digital audio broadcasting (DAB) is an innovative and universal broadcast system.

DAB stations are indicated by the programme name instead of the broadcasting frequency.

CD 500 / DVD 800:



CD 400:



General information

- With DAB, several radio programmes (services) can be broadcast on a single frequency (ensemble).
- Besides high-quality digital audio services, DAB is also able to transmit programme-associated data and a multitude of other data services including travel and traffic information.
- As long as a given DAB receiver can pick up the signal sent out by a broadcasting station (even if the signal is very weak), sound reproduction is ensured.
- There is no fading (weakening of the sound) that is typical of AM or FM reception. The DAB signal is reproduced at a constant volume.
- If the DAB signal is too weak to be picked up by the receiver, reception is interrupted completely. This incident can be avoided by:
 CD 500 / DVD 800: activating **Auto ensemble linking** in the DAB settings menu.

CD 400: activating **Auto ensemble linking** and/or **Auto linking DAB-FM** in the DAB settings menu.

- Interference caused by stations that are on nearby frequencies (a phenomenon that is typical of AM and FM reception) does not occur in connection with DAB.
- If the DAB signal is reflected by natural obstacles or buildings, the reception quality of DAB is improved, whereas AM or FM reception is considerably impaired in such cases.
- The reception of DAB+ stations is presently not supported by the DAB receiver.

Configuring DAB

CD 500 / DVD 800

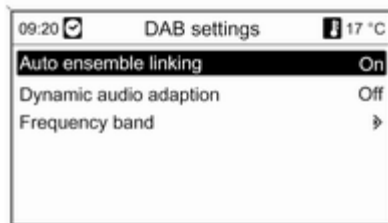

Press the **CONFIG** button.

Select **Radio settings** and then **DAB settings**.

The following options are available in the configuration menu:

- **Auto ensemble linking**: with this function activated, the device switches over to the same service (programme) on another DAB ensemble (frequency, if available) when the DAB signal is too weak to be picked up by the receiver.

- **Dynamic audio adaption**: with this function activated, the dynamic range of the DAB signal is reduced. That means the level of the loud sounds is reduced, but not the level of the quiet sounds. Therefore the volume of the Infotainment system can be raised to a point where the quiet sounds are audible, without the loud sounds being too loud.
- **Frequency band**: after selection of this option the user can define which DAB wavebands are to be received by the Infotainment system.

CD 400

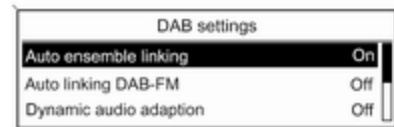

Press the **CONFIG** button.

Select **Radio settings** and then **DAB settings**.

The following options are available in the configuration menu:

- **Auto ensemble linking:** with this function activated, the device switches over to the same service (programme) on another DAB ensemble (frequency, if available) when the DAB signal is too weak to be picked up by the receiver.
- **Auto linking DAB-FM:** with this function activated, the device switches over to a corresponding FM station of the active DAB service (if available) when the DAB signal is too weak to be picked up by the receiver.
- **Dynamic audio adaption:** with this function activated, the dynamic range of the DAB signal is reduced. That means the level of the loud sounds is reduced, but not the level of the quiet sounds. Therefore the volume of the Infotainment system

can be raised to a point where the quiet sounds are audible, without the loud sounds being too loud.

- **Frequency band:** after selection of this option it can be defined which DAB wavebands are to be received by the Infotainment system.

CD/DVD player

General information	40
Usage	42

General information

CD 500 / DVD 800

The Infotainment system's CD/DVD player can replay audio CDs and MP3/WMA CDs as well as MP3/WMA DVDs (only DVD 800).

Important information about audio CDs and MP3/WMA CDs/DVDs

Caution

Under no circumstances place DVDs, single-CDs with a diameter of 8 cm or shaped CDs in the audio player.

You must not put any stickers on CDs. These discs can get jammed in the CD drive and ruin the drive. An expensive replacement of the device will then be necessary.

- Audio CDs with copy protection, which are not in compliance with the audio CD standard, may not play correctly or not at all.

- Self-recorded CD-Rs and CD-RWs are more vulnerable to mishandling than prerecorded CDs. Correct handling, especially in the case of self-recorded CD-Rs and CD-RWs, must be ensured; see below.
- Self-recorded CD-Rs and CD-RWs may not play correctly or not at all.
- On mixed mode CDs (combinations of audio and data, e. g. MP3), only the audio tracks will be detected and played.
- Avoid leaving fingerprints when you change CDs/DVDs.
- Put CDs/DVDs back in their sleeves immediately after removing them from the audio player in order to protect them from damage and dirt.
- Dirt and liquids on CDs/DVDs can smear the lens of the audio player inside the device and cause faults.
- Protect CDs/DVDs from heat and direct sunlight.
- The following restrictions apply for the data stored on an MP3/WMA CD/DVD:

Maximum folder structure depth: 11 levels.

Maximum number of MP3/WMA files that can be saved: 1000.

WMA files with Digital Rights Management (DRM) from online music shops cannot be played.

WMA files can only be played back safely if they were created with Windows Media Player version 8 or later.

Applicable playlist extensions: .m3u, .pls

Playlist entries must be in the form of relative paths.

- This chapter deals only with playing MP3 files since the operation for MP3 and WMA files is identical. When a CD/DVD with WMA files is loaded MP3 related menus are displayed.

CD 300 / CD 400

The Infotainment system's CD player can play audio CDs and MP3/WMA CDs.

Important information about audio CDs and MP3/WMA CDs

Caution

Under no circumstances place DVDs, single-CDs with a diameter of 8 cm or shaped CDs in the audio player.

You must not put any stickers on CDs. These discs can get jammed in the CD drive and ruin the drive. An expensive replacement of the device will then be necessary.

- The following CD formats can be used:
 - CD-ROM Mode 1 and Mode 2.
 - CD-ROM XA Mode 2, Form 1 and Form 2.
- The following file formats can be used:
 - ISO9660 Level 1, Level 2, (Romeo, Joliet).
 - MP3 and WMA files written in any format other than listed above may not play correctly, and their file

names and folder names may not be displayed correctly.

- Audio CDs with copy protection, which are not in compliance with the audio CD standard, may not play correctly or not at all.
- Self-recorded CD-Rs and CD-RWs are more vulnerable to mishandling than prerecorded CDs. Correct handling, especially in the case of self-recorded CD-Rs and CD-RWs, must be ensured. See below.
- Self-recorded CD-Rs and CD-RWs may not play correctly or not at all. In such cases it is not the equipment that is at fault.
- On mixed mode CDs (audio tracks and compressed files, e. g. MP3, are stored), the audio tracks part and the compressed files part can be played separately.
- Avoid leaving fingerprints when you change CDs.
- Put CDs back in their sleeves immediately after removing them from the CD player in order to protect them from damage and dirt.

- Dirt and liquids on CDs can smear the lens of the CD player inside the device and cause faults.
- Protect CDs from heat and direct sunlight.
- The following restrictions apply for the data stored on an MP3/WMA CD:
 - Number of tracks: max. 999.
 - Number of folders: max. 255.
 - Folder structure depth: max. 64 levels (recommended: max. 8 levels).
 - Number of playlists: max. 15.
 - Number of songs per playlist: max. 255.
 - Applicable playlist extensions: .m3u, .pls, .asx, .wpl.
- This chapter deals only with playing MP3 files since the operation for MP3 and WMA files is identical. When a CD with WMA files is loaded MP3 related menus are displayed.

Usage

CD 500 / DVD 800



Starting CD/DVD replay

Push CD/DVD with the labelled side upward into the CD/DVD slot until it is pulled in.

CD/DVD replay starts automatically and the **Audio CD** or **Audio MP3** menu is displayed.

If there is already a CD/DVD in the unit, but the **Audio CD** or **Audio MP3** menu is not active:

Press **CD/AUX** button.

The **Audio CD** or **Audio MP3** menu is opened and CD/DVD replay is started.

Depending on the data stored on the audio CD or MP3 CD/DVD differing information about the CD/DVD and the current music track will be shown on the display.

If the **Audio CD** or **Audio MP3** menu does not appear after pressing the **CD/AUX** button, there is still a navigation DVD in the CD/DVD slot. Press **△** button to remove the DVD.

Selecting a track

Turn the multifunction knob to display a list of all tracks on the CD/DVD. The currently played track is preselected. Select the desired track.

Skipping to the next track or previous track

Briefly press **◀◀ K** or **K ▶▶** button once or several times.

Track search forward or backward

Briefly press << K or M >> button and then press << K or M >> button again and keep pressed until the desired track is displayed.

Fast forward or rewind

Press the button << K or M >> and hold it down to fast forward or rewind the current track.

Selecting tracks using the audio CD or MP3 menu

During audio CD replay



Press the multifunction knob to open the audio CD related menu.

To play all tracks in random order: set **Shuffle songs (RDM)** to **On**.

To select a track on the audio CD: select **Track list** and then select the desired track.

During MP3 replay

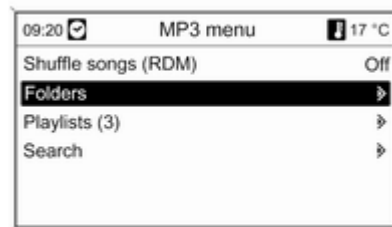

Press the multifunction knob to open the MP3 related menu.

To play all tracks in random order: set **Shuffle songs (RDM)** to **On**.

To select a track from a folder or playlist (if available): select **Folders** or **Playlists**.

Select a folder or playlist and then select the desired track.

Select **Search** to open a menu with additional options for track search and selection.

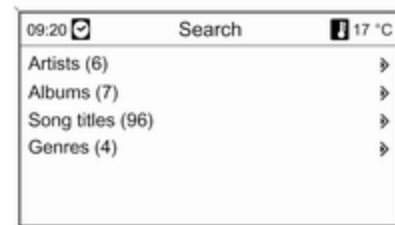

Depending on the amount of tracks saved, the search process may take several minutes.

Select a search option and then select the desired track.

Removing a CD/DVD

Press **△** button.

The CD/DVD is pushed out of the CD/DVD slot.

If the CD/DVD is not removed after ejection, it will be drawn back in again automatically after a few seconds.

CD 300 / CD 400

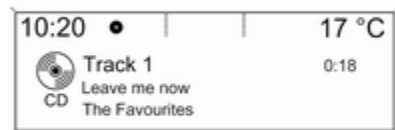

Starting CD replay

Press the **CD/AUX** button to open the CD or MP3 menu.

If there is a CD in the CD player, CD replay is started.

Depending on the data stored on the audio CD or MP3 CD differing information about the CD and the current music track will be shown on the display.

Inserting a CD

Insert a CD with the printed side facing up into the CD slot until it is drawn in.

Changing the standard page view (only CD 300)

During audio CD or MP3 replay: press the multifunction knob and then select **Default CD page view** or **Default MP3 page view**.

Select the desired option.

Changing the folder level (only CD 300, MP3 replay)

Press the button or to change to a higher or lower folder level.

Skipping to the next track or previous track

Briefly press the button or .

Fast forward or rewind

Press the button or and hold it down to fast forward or rewind the current track.

Selecting tracks using the audio CD or MP3 menu

During audio CD replay

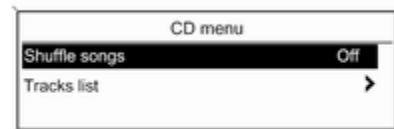

Press the multifunction knob to open the audio CD related menu.

To play all tracks in random order: set **Shuffle songs** to **On**.

To select a track on the audio CD: select **Tracks list** and then select the desired track.

During MP3 replay

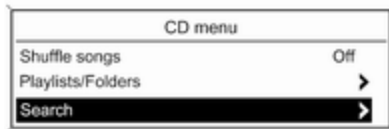

Press the multifunction knob to open the MP3 related menu.

To play all tracks in random order: set **Shuffle songs** to **On**.

To select a track from a folder or playlist (if available): select **Playlists/Folders**.

Select a folder or playlist and then select the desired track.

Notice

If a CD contains both audio and MP3 data, the audio data can be selected from **Playlists/Folders**.

To open a menu with additional options for track search and selection: select **Search**. What options are available depends on the data saved on the MP3 CD.

The search process on the MP3 CD may take several minutes. During this time the station last played will be received.

Removing a CD

Press the \triangle button.

The CD is pushed out of the CD slot.

If the CD is not removed after ejection, it will be drawn back in again automatically after a few seconds.

AUX input

General information	46
Usage	46

General information



Under the cover on the centre console there is an AUX socket for the connection of external audio sources.

Notice

The socket must always be kept clean and dry.

It is possible, for example, to connect a portable CD player with a 3.5 mm jack plug to the AUX input.

Usage

CD 500 / DVD 800

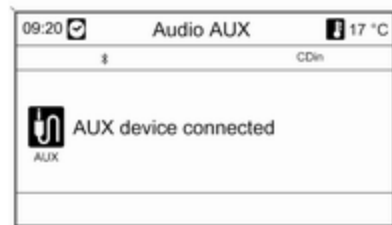

Press the **CD/AUX** button once or several times to activate the AUX mode.

An audio source that is connected to the AUX input can be operated only via the control elements of the audio source.

CD 300 / CD 400



Press the **CD/AUX** button once or several times to activate the AUX mode.

An audio source that is connected to the AUX input can be operated only via the control elements of the audio source.

USB port

General information	48
Playing saved audio files	50

General information

CD 500 / DVD 800



Under the cover on the centre console there is a USB socket for the connection of external audio data sources.

Notice

The socket must always be kept clean and dry.

An MP3 player, USB drive or an iPod can be connected to the USB port.

When connected to the USB port, various functions of those devices can be operated via the controls and menus of the Infotainment system.

Important information

MP3 player and USB drives

- The MP3 players and USB drives connected must comply with the USB Mass Storage Class specification (USB MSC).
- Only MP3 players and USB drives with a cluster size smaller or equal 64 kBytes in the FAT16/FAT32 file system are supported.
- Hard disk drives (HDD) and are not supported.
- USB hubs are not supported.
- The following restrictions apply for the data stored on an MP3 Player or USB device:

Maximum folder structure depth: 11 levels.

Maximum number of MP3/WMA files that can be saved: 1000.

WMA files with Digital Rights Management (DRM) from online music shops cannot be played.

WMA files can only be played back safely if they were created with Windows Media Player version 8 or later.

Applicable playlist extensions: .m3u, .pls

Playlist entries must be in the form of relative paths.

The system attribute for folders/files that contain audio data must not be set.

Notice

Do not insert a USB drive device longer than 70 mm. A longer device may be damaged when folding down the armrest.

Supported iPod models

- iPhone (3rd generation)
- iPod touch (1st and 2nd generation)
- iPod classic (6th generation)

- iPod with video (5th and 5.5th generation)
- iPod nano (1st, 2nd, 3rd, and 4th generation)

There may be problems with operation and function in the following situations:

- When connecting an iPod on which a more recent version of the firmware is installed than is supported by the Infotainment system.
- When connecting an iPod on which firmware from other providers (e. g. Rockbox) is installed.

CD 400



Under the cover on the centre console there is a USB socket for the connection of external audio data sources.

Devices connected to the USB port are operated via the controls and menus of the Infotainment system.

Notice

The socket must always be kept clean and dry.

Important information

The following devices can be connected to the USB port:

- iPod
- Zune
- PlaysForSure device (PFD)
- USB drive

Notice

Not all iPod, Zune, PFD or USB drive models are supported by the Infotainment system.

Notice

Do not insert a USB drive device longer than 70 mm. A longer device may be damaged when folding down the armrest.

Playing saved audio files

CD 500 / DVD 800

MP3 player / USB drives



Press the **CD/AUX** button once or several times to activate the audio USB mode.

Replay of the audio data stored on the USB device is started.

The operation of audio data sources connected via USB is the same as for an audio MP3/WMA CD/DVD ↻ 42.

iPod



Press the **CD/AUX** button once or several times to activate the audio iPod mode.

Replay of the audio data stored on the iPod is started.

The operation of the iPod connected via USB is mainly the same as for an audio MP3/WMA CD/DVD ↻ 42.

Below only the aspects of operation that are different/additional are described.

iPod functions

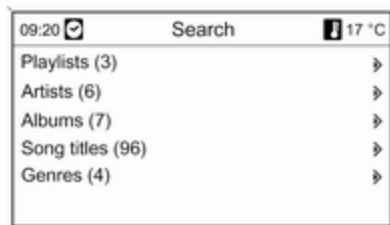

Depending on the data saved, there are various options for the selection and playing of tracks.

Press the multifunction knob and then select **Search** to display the options available.

The search process on the device may take several seconds.

CD 300 / CD 400



Press the **CD/AUX** button once or several times to activate the USB mode.

Replay of the audio data stored on the USB device is started.

The operation of data sources connected via USB is mainly the same as for an audio MP3 CD ↻ 42.

Below only the aspects of operation that are different/additional are described.

Operation and the screen displays are described for USB drives only. Operation of other devices like iPod or Zune is mainly the same.

Selecting tracks using the USB menu



Press the multifunction knob to open the USB related menu.

To play all tracks in succession: select **Play all**.

To display a menu with various additional options for track search and selection: select **Search**.

The search process on the USB device may take several minutes. During this time the station last played will be received.

To play all tracks in random order: set **Shuffle songs (random)** to **On**.

To repeat the currently played track: set **Repeat** to **On**.

Navigation

General information	53
Usage	55
Destination input	59
Using the address book	69
Guidance	71
Dynamic guidance	78
Symbols overview	80

General information

The navigation system will reliably guide you to your destination without the need to read maps, even if you have no local knowledge whatsoever.

The current traffic situation is taken into account in the route calculation if dynamic route guidance is used. For this purpose the Infotainment system receives traffic announcements in the current reception area via RDS-TMC.

The navigation system cannot, however, take into account traffic incidents, traffic regulations changed at short notice and hazards or problems that arise suddenly (e. g. road works).

Caution

The usage of the navigation system does not release the driver from the responsibility for a correct, vigilant attitude in road traffic. The relevant traffic regulations must always be followed. If a navigation instruction contradicts traffic regulations, the traffic regulations always apply.

Functioning of the navigation system

The position and movement of the vehicle are detected by the navigation system using sensors. The travelled distance is determined by the vehicle's speedometer signal, turning movements on bends by a gyro sensor. The position is determined by the GPS satellites (Global Positioning System).

By comparing the sensor signals with the digital maps on the navigation CD/DVD, it is possible to determine the position with an accuracy of approx. 10 m.

The system will also work with poor GPS reception, however, the accuracy of the determination of the position will be reduced.

After the entry of the destination address or point of interest (nearest petrol station, hotel, etc.) the route is calculated from the current location to the destination selected.

The route guidance is provided by voice output and an arrow, as well as with the aid of a multi-colour map display.

TMC traffic information system and dynamic route guidance

The TMC traffic information system receives all current traffic information from TMC radio stations. If dynamic route guidance is active, this information is included in the calculation of the overall route. During this process, the route is planned so that traffic problems related to pre-selected criteria are avoided.

If there is a traffic problem during active route guidance, depending on the pre-settings, a message appears as to whether the route should be changed.

TMC traffic information is displayed in the route guidance display as symbols or as detailed text on the **TMC messages** menu.

To be able to use TMC traffic information, the system has to receive TMC stations in the relevant region.

Dynamic route guidance only works if traffic information is received via the TMC traffic information system.

The dynamic route guidance function can be deactivated ⇨ 71.

Map material

The complete map material is too extensive to be loaded into the system's memory.

For international navigation, insert the navigation CD/DVD or load the related data for the regions into the system memory. The network of main roads in Europe is loaded

automatically. It may be necessary to delete other map material from the system memory.

Once the preferred map material has been loaded, the CD/DVD can be removed so that the drive can be used for playing music.

Map data add/remove ⇨ 55.

Important information on map CDs/DVDs

Caution

Under no circumstances place DVDs, single-CDs with a diameter of 8 cm or shaped CDs in the audio player.

You must not put any stickers on CDs. These discs can get jammed in the CD drive and ruin the drive. An expensive replacement of the device will then be necessary.

- Only use map CDs/DVDs approved by the vehicle manufacturer. The Infotainment system will not read map CDs/DVDs from other manufacturers.
- It is recommended to always use the latest map CD/DVD approved by the vehicle manufacturer for the Infotainment system.
- Avoid leaving fingerprints when you change map CDs/DVDs.
- Put map CDs/DVDs back in their sleeves immediately after removing them from the Infotainment system in order to protect them from damage and dirt.
- Dirt and liquids on map CDs/DVDs can smear the lens of the CD/DVD player inside the device and cause faults.
- Protect map CDs/DVDs from heat and direct sunlight.

Usage

Control elements

The most important navigation-specific control elements are the following:

NAV button: activate navigation; show current position (if route guidance inactive); show calculated route (if route guidance active); toggle between full map display, arrow display (if route guidance active) and split screen display, see "Information on the display".

DEST button: open menu with options for destination entry.

Eight-way switch: move display window in navigation map view; to select the destination, press in the required direction to position the crosswires over a destination on the map.

RPT button: repeat last route guidance message.

Activating the navigation system

Press the **NAV** button.

The map of the current location is shown on the display.

Loading a map CD/DVD

To load additional map material for a country, push the map CD/DVD with the labelled side upward into the CD/DVD slot until it is pulled in.

Removing a map CD/DVD

Press the \triangle button. The CD/DVD is pushed out of the CD/DVD slot.

If the CD/DVD is not removed after ejection, it will be drawn back in again automatically after a few seconds.

Setting the navigation volume

Description ⇨ "Setting up the navigation system".

Information on the display

Route guidance not active

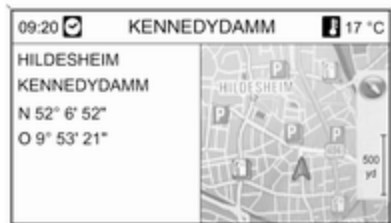

If route guidance is not active the following information is displayed:

- In the top line: street name of current position.
- Address and geographic coordinates of current position.
- Map display of the area around the current position.
- Current position marked by a red triangle.
- A compass symbol that indicates the north direction.

- If no GPS signal ⇨ 53 is available at the current position: a crossed "GPS" symbol is displayed below the compass symbol.
- The currently selected map scale (change scale: turn multifunction knob).

Route guidance active

If route guidance is active the following information, depending on the current **Navigation options** settings ⇨ 71, is displayed.

Information in the top line



- Time
- Distance to final destination or next intermediate destination on a tour (if available)
- Arrival time or travel time
- Exterior temperature

Information on the arrow display

- The direction to follow.
- Distance to the next intersection.
- Streets leading off the current street to follow.
- Below the arrow symbol: the name of the current street to follow.
- Above the arrow symbol: the name of the street to follow after the next intersection.
- When reaching a highway intersection information regarding lane guidance is displayed:



If the option **Highway lane guidance** is activated in the **Display route guidance** menu ⇨ 71 the following type of illustration is displayed:



Information on the map display

On the right side of the display the following information is shown:

- A compass symbol that indicates the north direction.
- If no GPS signal ⇨ 53 is available at the current position: a crossed "GPS" symbol is displayed below the compass symbol.
- The currently selected map scale (change scale: turn multifunction knob).

On the map the following information is shown:

- The route as a blue line.
- The current position as a red triangle.
- The final destination as a chequered flag.
- Various symbols ⇨ 80 that indicate traffic information and general information or points of interest.

Setting up the navigation system

To open the setup menu with navigation-specific settings: press the **CONFIG** button and then select **Navigation settings**.

The following options are available:

- **Navigation volume**
- **TMC settings**
- **Delete lists**
- **Map data add / remove**
- **Erase map data memory**
- **Delete Home address**

Navigation volume

The relative volumes of the navigation message (**Announcement**) and the audio source (**Background**) during a navigation message can be preset.

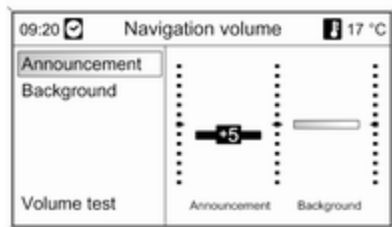

Set the desired values for **Announcement** and **Background**.

To test the current settings: select **Volume test**.

TMC settings

Infotypes

Select **Infotypes** to open a submenu with various options to define whether and which traffic message infotypes are to be displayed on the active route guidance map.

When **User defined** is selected the infotypes, that are to be displayed, can be defined.

Sort criteria

Select whether traffic messages are to be displayed in an order based on distance or based on the street name.

Warning messages when route guidance is inactive

Decide whether the Infotainment system should announce warning messages even if no route guidance is active.

Delete lists

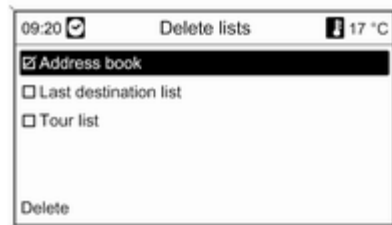

Select whether all entries in the **Address book**, in the **Last destinations** and/or in the **Tours** list are to be deleted.

Map data add / remove

(not available when route guidance active)

Country specific map data can be loaded from the map CD/DVD into the Infotainment system's internal memory and removed from the internal memory.



Insert the map CD/DVD

The amount of free memory in the internal memory is displayed in the top line.

Select the maps to be loaded into the internal memory.

Deselect the maps to be removed from the internal memory.

Select **Confirm** to load/remove the selected maps.

The loading/removing process may take some time depending on the amount of data to be loaded and/or removed.

The duration of the loading/removing process given is a rough estimate that does not take into account any other active functions, e. g. playing MP3 files.

If the loading/removing process is interrupted by switching off the Infotainment system, the process must be restarted manually after the Infotainment system is switched on.

The related map material already loaded will be removed from the memory if the loading/removing process is cancelled manually. This process can take some time.

Erase map data memory

If navigation is not possible using the data from the internal memory, or if there is an error message on loading/

removing map material, this command can be used to quickly and completely erase the internal memory.

Delete Home address

This command deletes the currently set Home address ↷ 59.

Destination input

Press the **DEST** button to open a menu with various options for the destination input:

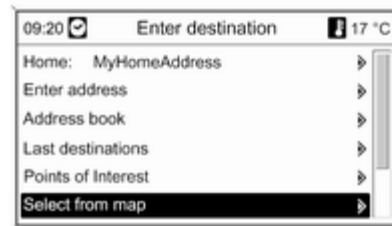

- **Home:** selection of the currently set Home address (predefined in the address book ↷ 69).
- **Enter address:** direct entry of a destination address with country, city, street and house number.
- **Address book:** selection of an address already stored in the address book.
- **Last destinations:** selection from a list of recently selected destinations.
- **Points of Interest:** selection from a list of points of interest (restaurants, hotels, petrol stations, etc.) near the current position, the destination, other locations or selection from the map, as well as search by name or phone number.
- **Select from map:** selection from the map display using the eight-way switch ↷ 4.
- **Latitude / Longitude:** selection of a destination using geographic coordinates.

- **Travel guide** (only DVD 800): feature for displaying points of interest based on travel guide criteria (e. g. accomodation, sights, leisure etc.) in a selected place.
- **Tours** (only DVD 800): selection of a predefined tour with intermediate waypoints/destinations.

Entering an address directly

Press the **DEST** button and then select **Enter address**.



To change/select the country: mark the country input field and press the multifunction knob to open the **Countries** menu.

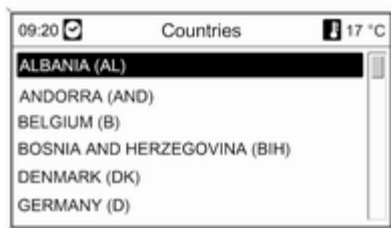

Select the desired country.

Entering an address using the speller function

Mark the **City:** input field and press the multifunction knob to activate the speller function.



Using the multifunction knob, successively mark and accept the letters for the city desired. During this process the system will automatically block letters that cannot occur next in the city name.

The following symbols can be selected in the bottom line:

↑ : Lists with special characters are displayed in the bottom line.

◀▶ : Previous/next letter is marked.

✕ : Delete last character.

Aa : Upper, lower case.

☐ : List function - once two letters have been entered, in some cases just one letter, all names available with these letters are displayed. The more letters are entered, the shorter becomes the list.

OK : Complete entry or accept search term.

By a long press on the **BACK** button all letters and characters entered are deleted at once from the input line.

Repeat the process for the remaining input fields.

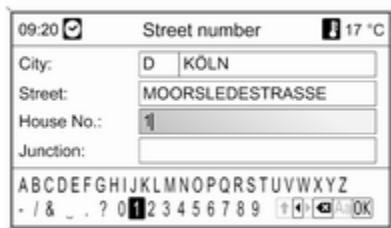

After completing the address select **OK**.

The **Navigation** menu is displayed, description ↷ 71.

Selecting an address from the address book

Description ↷ 69.

Selecting a previous destination



Press the **DEST** button and then select **Last destinations**.

A list of destinations entered/selected recently is displayed.

Select the desired destination.

The **Navigation** menu is displayed, description ↷ 71.

Selecting a point of interest

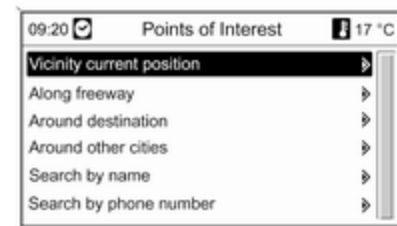

Press the **DEST** button and then select **Points of Interest**.

Various options for the selection of points of interest (e. g. restaurants, petrol stations, hospitals etc.) are displayed.

Vicinity current position

Selection of points of interest close to the vehicle's current position.

For example, you are looking for a petrol station:

Select **Automotive & Petrol Stations** and then **Automotive & Petrol Stations**.

A menu is displayed that allows further refinement of the petrol station search.

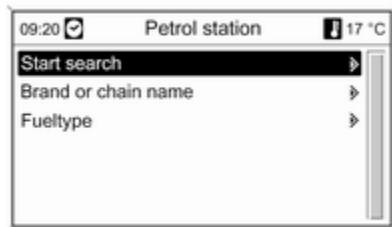

After selecting **Start search** a search for all petrol stations in the area is started. The search takes into account all petrol stations that meet the currently set filter criteria for **Brand or chain name** and **Fueltype**, see further down "Setting filters for search refinement".

After the search is finished a list of all found petrol stations is displayed.

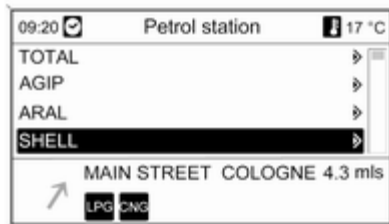

Below the list information on the distance, the direction to follow and the available fuel types (in addition to petrol and Diesel) is displayed.

Abbreviations used for fuel types:

- **CNG**: Compressed natural gas
- **LPG**: Liquefied petroleum gas

Select the desired petrol station.

The **Navigation** menu is displayed, description ↗ 71.

Setting filters for search refinement

After selecting **Brand or chain name** a list is displayed with all available petrol station brands/chains in the area.



The number of petrol stations can be reduced by marking at least one petrol station brand/chain.

After marking the desired brands select **Start search with selected filters** or **Continue with next filter** (fuel types) for further refinement of the search.

After selecting **Fueltype** a list is displayed with all fuel types available (in addition to petrol and Diesel) at petrol stations in the area.

The number of petrol stations can be reduced by marking at least one fuel type.

After marking the desired fuel types **Start search with selected filters** or **Continue with next filter** (petrol station brands/chains) for further refinement of the search.

After starting a search a list of all petrol stations that meet the previously selected filter criteria is displayed.

Along freeway

Selection of motorway related points of interest (e. g. petrol stations or service areas) along the route. Only available when you are currently driving on a motorway.

Selecting a point of interest: see example above for „Vicinity current position“.

Around destination

Selection of points of interest close to the destination entered.

Selecting a point of interest: see example above for „Vicinity current position“.

Around other cities

Selection of points of interest around any city.

Select the desired country.



Enter the desired city using the letter function ↵ 59.

Once the entry is specific enough a list with possible cities is displayed. Sometimes it may be necessary to select  for displaying the list.

Select the desired city. A menu appears on which the points of interest close to the selected city are listed by category.

Selecting a point of interest: see example above for „Vicinity current position“.

Search by name

Selection of points of interest by entering a name.

Select the desired country.

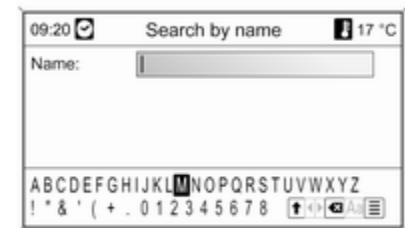

Enter the name of the desired point of interest using the letter function ⇨ 59.

Once the entry is specific enough a list with possible points of interest is displayed. Sometimes it may be necessary to select  for displaying the list.

Select the desired point of interest.

The **Navigation** menu is displayed, description ⇨ 71.

Search by phone number

Selection of points of interest by entering a telephone number.

Select the desired country.



Enter the desired telephone number using the letter function ⇨ 59.

Once the entry is specific enough a list with possible points of interest is displayed. Sometimes it may be necessary to select  for displaying the list.

Select the desired point of interest.

The **Navigation** menu is displayed, description ⇨ 71.

Selecting a destination from the map

Press the **DEST** button and then select **Select from map**.



Notice

The map scale can be changed by turning the multifunction knob.

Using the eight-way switch on the multifunction knob position the crosswire on a destination on the map.

Press the multifunction knob to confirm the selection.

The **Navigation** menu is displayed, description ⇨ 71.

Selecting a destination via geographic coordinates

Press the **DEST** button and then select **Latitude / Longitude**.

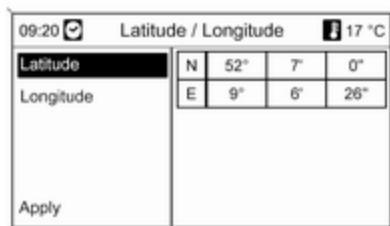

Select **Latitude**.

Turn the multifunction knob to select **N** or **S** (north or south of the equator).

Press the multifunction knob to confirm the selection.

Turn the multifunction knob to enter the desired degrees of latitude.

Press the multifunction knob to confirm the entry.

Enter the desired values for the latitude minutes and seconds.

Select **Longitude**.

Turn the multifunction knob to select **W** or **E** (west or east of the prime meridian in Greenwich).

Press the multifunction knob to confirm the entry.

Enter and confirm the desired values for the longitude degrees, minutes and seconds.

Select **Apply**.

The **Navigation** menu is displayed, description ↷ 71.

Travel guide

(only DVD 800)

Notice

If data from the internal memory is used for navigation, the travel guide is only available for the regions saved.

Press the **DEST** button and then select **Travel guide**.

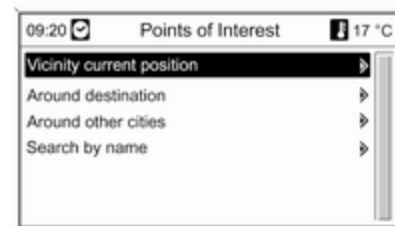

Various options for the selection of points of interest based on travel guide criteria (e. g. accomodation, sights, leisure etc.) are displayed.

Selecting a point of interest based on travel guide criteria: see the corresponding descriptions in „Selecting a point of interest“.

Tours

(only DVD 800)

A tour makes it possible to enter a series of destinations for driving to one after the other. This function is suitable for regular, repetitive tours so that it is not necessary to re-enter

individual destinations. Tours are saved using a name. A maximum of ten tours with 9 intermediate destinations can be saved. An existing tour can be changed by modifying the order of the destinations or by adding or deleting destinations.

Adding a tour



After selecting **New tour**, enter a name for the tour using the letter function ↵ 59.

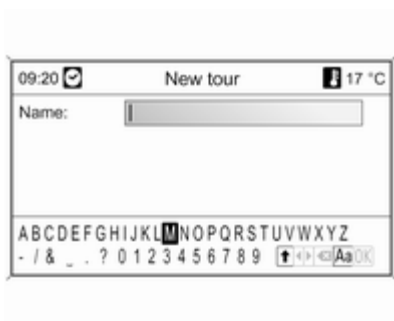

Accept the entered name using **OK**. The name is displayed on the **Tours** menu.

Adding intermediate destinations to the tour

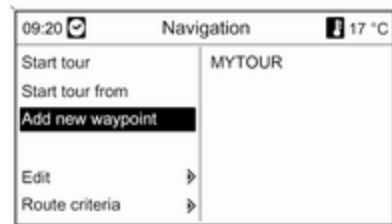

Select the new tour and then **Add new waypoint**.

In the submenu **Add waypoint** the following options for selecting/entering intermediate destinations are displayed:

- **Enter waypoint** (address entry)
- **Address book**
- **Last destinations**
- **Select from map**
- **Points of Interest**

Select an option for destination input and then select/enter the desired intermediate destination ↗ 59.

A menu is displayed that shows the address data of the selected/entered intermediate destination.



After selecting **Add** a list with all previously added intermediate destinations is displayed.



By default new waypoints are added at the end of the list. If another position is desired turn the multifunction knob to select another insertion point.

Repeat the described procedure to add further intermediate destinations.

Starting a tour



Select a tour in the **Tours** menu. The **Navigation** menu is displayed.

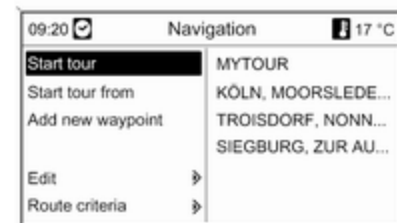

To start route guidance: select **Start tour**. All predefined intermediate destinations are taken into account for route calculation.

If you want to skip predefined intermediate destinations on the tour and start direct route guidance to a certain destination: select **Start tour from**. A list with all predefined intermediate destinations is displayed.



Select the desired next destination. A route is calculated that leads directly to the selected intermediate destination.

Editing a tour

Select a tour in the **Tours** menu and then select **Edit tour** to display a submenu with the following options:



Move waypoints

Displays a list with all intermediate destinations on the selected tour.

Move waypoints

Displays a list with all intermediate destinations on the selected tour.

Mark the intermediate destination to be moved.

Press the multifunction knob to cut out the marked destination.

To insert the cut out destination at the end of the list: press the multifunction knob again.

To insert the cut out destination before another destination: mark this destination and then press the multifunction knob.

Delete waypoints

Displays a list with all intermediate destinations on the selected tour.

Mark the desired intermediate destination and then press the multifunction knob.

Confirm the displayed message.

Delete tour

Deletes the currently selected tour entirely.

To execute deletion confirm the displayed message.

Edit name

The name of the currently selected tour can be edited using the letter function ↵ 59.

Fuel level low alert

When the fuel level in the vehicle's tank is low an alert message is displayed.

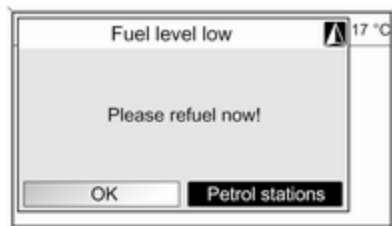

To start a search for petrol stations close to the vehicle's current position: select **Petrol stations**.

After the search is finished a list of all found petrol stations is displayed.

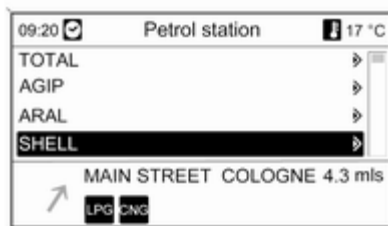

Below the list information on the distance, the direction to follow and the available fuel types (in addition to petrol and Diesel) is displayed.

Abbreviations used for fuel types:

- **CNG**: Compressed natural gas
- **LPG**: Liquefied petroleum gas

Select the desired petrol station. The **Navigation** menu is displayed.

Select **Start navigation** to start the route guidance ⇨ 71.

Description of all **Navigation** menu options ⇨ 71.

Using the address book

Adding and saving an address in the address book

Press the **DEST** button and then select **Enter address**.



Enter the desired address ⇨ 59.

After completing the address select **OK**. The **Navigation** menu is displayed.

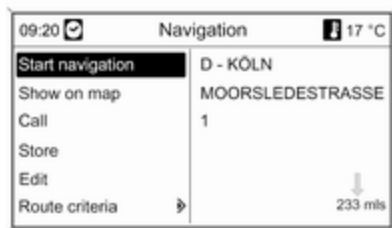

Select **Store**.

The menu **Store** is displayed with the entered address as default name.



The default name can be changed using the letter function ↵ 59.

Select **OK** to store the address in the address book using the displayed name.

A maximum of 100 destinations can be saved in the address book.

Selecting an address from the address book

Press the **DEST** button and then select **Address book** to display the address book entries.

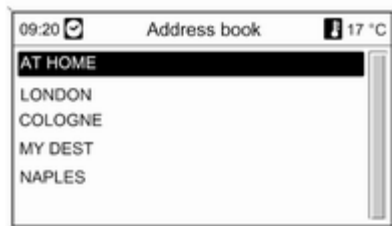

Select the desired address book entry.

The **Navigation** menu is displayed, description ↵ 71.

Changing an address name, deleting an address or setting the Home address

Press the **DEST** button, select **Address book**, select the desired address name and then select **Edit**.

The **Edit** menu is displayed.

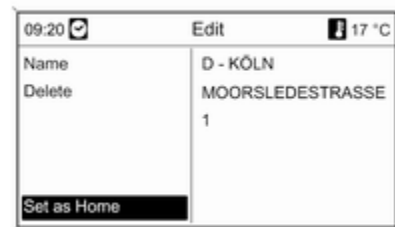

The following options are displayed:

- **Name:** enter a name for the displayed address using the letter function ↵ 59.
- **Delete:** delete the displayed address from the address book.
- **Set as Home:** set the displayed address as Home address. This Home address can then be selected as destination in the **Enter destination** menu ↵ 59.

Guidance

Press the multifunction knob to display the navigation main menu. Depending on whether the route guidance is currently active or inactive different menu options are available.

Functions with route guidance inactive

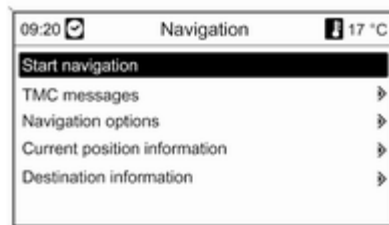

Start navigation

After selecting **Start navigation** the **Navigation** menu is displayed ↵ 71.

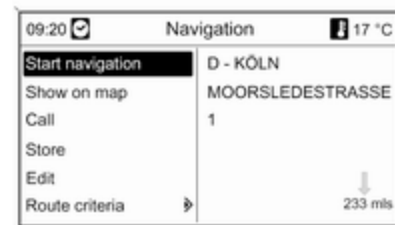

The following options are available:

- **Start navigation:** the route guidance to the displayed address is started ↵ 71.
- **Show on map:** show the location of the displayed address on a map.
- **Call:** if the address data includes a telephone number (only available for Points of interest) and a Phone portal is available the telephone number will be dialed.
- **Store:** store address in the address book ↵ 69.

- **Edit:** change address name, delete address from address book or set address as Home address ↗ 69.
- **Route criteria:** set/change criteria for route calculation, see "Navigation options".

TMC messages

Information on TMC ↗ 53.

Select **TMC messages** to display a list of all TMC traffic messages that are currently received.

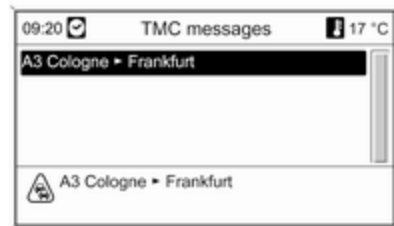

Select a TMC traffic message to display detailed information on the related traffic issue.

Navigation options

The corresponding menu provides options and a multitude of relating submenus for route guidance configuration.

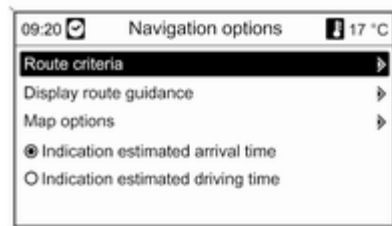

Route criteria

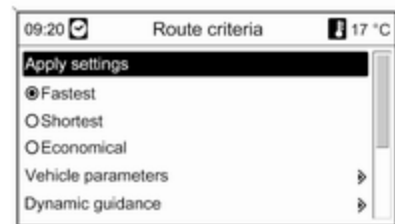

The calculation of the route can be controlled by various criteria.

Select one of the following criteria:

- **Fastest**
- **Shortest**
- **Economic**

Select **Vehicle parameters** to open a menu for the selection of vehicle specific parameters.

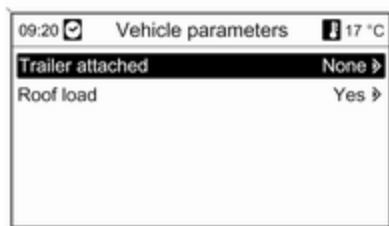

The selected parameters will be taken into account for route calculation.

After setting the desired vehicle parameters press the **BACK** button to leave the menu.

Select **Dynamic guidance** to open a menu for the configuration of dynamic route guidance.

Information on dynamic route guidance ↗ 78.

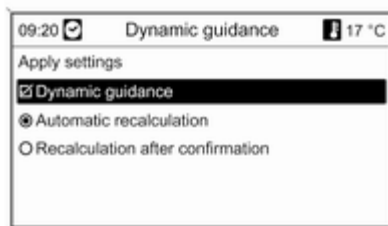

Select **Dynamic guidance** to activate/deactivate dynamic route guidance.

If dynamic route guidance is activated:

Select **Automatic recalculatation** if the route needs to be recalculated automatically when there are traffic problems.

Select **Recalculatation after confirmation** if the route needs to be recalculated not before the corresponding prompt has been confirmed.

Select **Apply settings** to activate the displayed settings and to leave the menu.

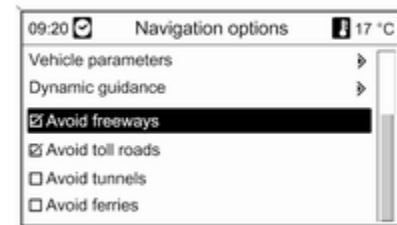

If desired select one or several of the following options in the **Navigation options** menu:

- **Avoid freeways**
- **Avoid toll roads**
- **Avoid tunnels**
- **Avoid ferries**

Display route guidance

The following options are available for the display of route guidance:

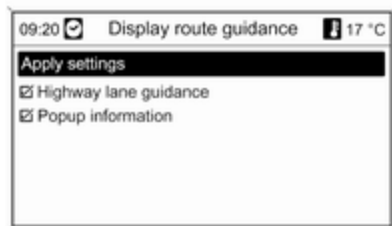

Using the **Popup information** option, it can be determined which type of illustration is to be shown when reaching a highway intersection.

If **Popup information** is deactivated the following type of illustration will be shown:



If **Popup information** is activated the following type of illustration will be shown:



Using the **Popup information** option, you can select whether route guidance information from the navigation is to be displayed in popup windows in other operating modes (e. g. radio). The information is hidden after a set time or by pressing the **BACK** button.

Select **Apply settings** to activate the displayed settings and to return to the **Navigation options** menu.

Map options

Select **Map options** and then **Map mode** to display the following submenu:

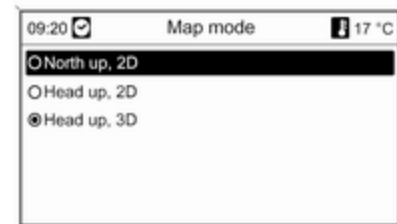

Select between map orientation (North up/Head up) and dimension (2D/3D) on the map display (3D only available for DVD 800).

Select **Map options** and then **Show POIs on map** to open a submenu with various options to define whether and which points of interest are to be displayed on the map.

When **User defined** is selected the type of points of interest can be defined that are to be displayed, e. g. restaurant, hotel, public places, etc.

Display of arrival time or driving time

After selection of the option

- Indication estimated driving time or
- Indication estimated arrival time

in the menu **Navigation options** the corresponding time is shown in the top line on the route guidance screen.

Current position information

The following information on the current position is displayed:

- City
- Street name
- Latitude
- Longitude
- Map display

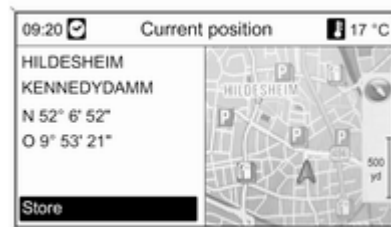

The actual position can be copied to the address book using **Store**. For this purpose, assign a name using the letter function ↵ 59.

Destination information

Displayed information: same as on the display for **Current position**.

Functions for active route guidance

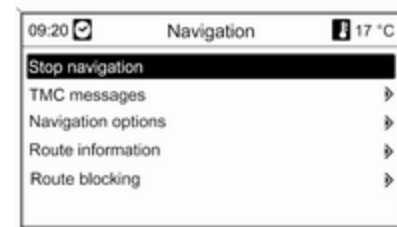

Stop navigation

After selecting **Stop navigation** the route guidance is deactivated and the menu options for route guidance inactive are displayed ↵ 71.

TMC messages

Information on TMC ↵ 53.

After selecting **TMC messages** the **Filtering** menu is displayed.

Select whether **All traffic messages** or only **Traffic messages along route** are to be displayed in the **TMC messages** list, see below.

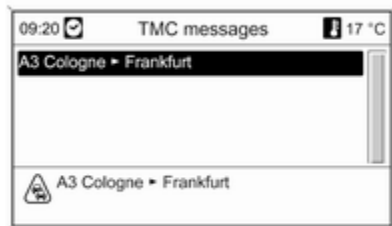

Navigation options

Description ⇨ **Functions with route guidance inactive.**

Route information

The following information can be accessed on the **Route information** menu:

- **Route list**
- **Current position information**
- **Destination information**
- **Overview current route**

Route list

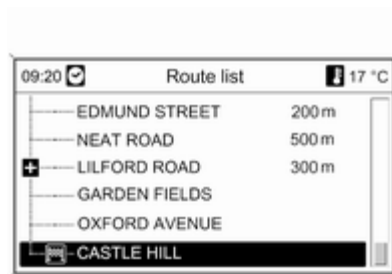

All streets on the calculated route are given with the related distances.

Route list items marked with a "+" symbol can be expanded by selecting the related list item. After selection further details of the related list item are displayed.

Current position information

Description ⇨ **Functions with route guidance inactive.**

Destination information

Description ⇨ **Functions with route guidance inactive.**

Overview current route

The following information on the current route is displayed:



- Position
- Destination
- Arrival time
- Distance
- Map display

Route blocking

The following options are available to manually exclude certain areas/route sections from the route guidance:

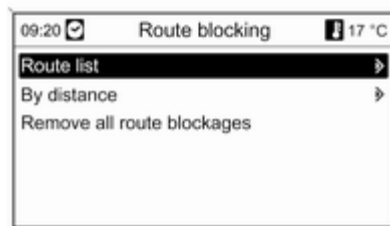

Route list

In the list of street names on the currently calculated route, streets can be excluded from the route guidance.



To exclude a street from the route guidance:

Mark the regarding street name and press the multifunction knob. The street name is displayed crossed-out.

If desired exclude further streets from the route guidance.

Press **Apply settings** and confirm the displayed message.

The route is re-calculated taking into account the excluded streets.

By distance

By setting a distance the section of route from the current position to the set distance can be excluded from the route guidance.

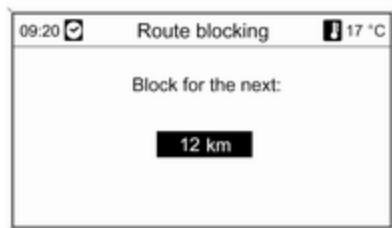

Set the desired distance, press the multifunction knob and confirm the displayed message.

The route is re-calculated taking into account the excluded route section.

Notice

The route blocking entered remains active until a new route calculation is performed.

Remove all route blockages

After selecting this option all areas/ route sections previously selected as to be excluded from the route guidance will be taken into account again for route guidance.

Repeat last navigation message

Press the **RPT** button to repeat the last route guidance message.

Dynamic guidance

If dynamic route guidance is active, the entire current traffic situation that the Infotainment system receives via TMC is included in the calculation of the route. The route is suggested taking into account all traffic problems or restrictions as per pre-set criteria (e. g. „shortest route“, „avoid freeways“ etc.).

In the case of a traffic problem (e. g. traffic jam, closed road) on the route driven, a message is displayed and a voice message output indicating the nature of the problem. The driver can decide whether to drive around the traffic problem taking the suggested change to the route or to carry on through the traffic problem.

Nearby traffic problems are also reported if route guidance is not active.

If route guidance is active, the system continuously checks, based on the traffic information, whether it would be better to recalculate the route or take an alternative route taking into account the current traffic situation.

The activation and deactivation of dynamic route guidance, as well as criteria for the calculation of the route and other settings for navigation, are made in the **Navigation options** menu ↻ 71.

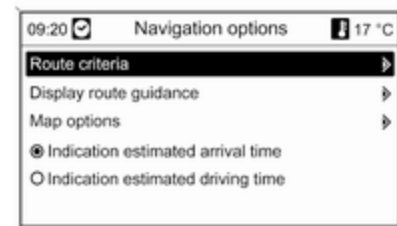

Dynamic route guidance only works if traffic information is received via the RDS-TMC traffic information system.

The possible delay due to a traffic problem calculated by the Infotainment system is based on data that the system receives via the RDS-TMC station currently set. The actual delay may be different to that calculated.

Symbols overview



1



9



17



25



2



10



18



26



3



11



19



27



4



12



20



28



5



13



21



29



6



14



22



30



7



15



23



31



8



16



24



32

No.	Explanation
1	Current position
2	Destination
3	not available
4	not available
5	not available
6	Fog
7	Road works
8	Slippery road
9	Smog
10	Snow
11	Storm
12	Caution/warning
13	Closed road
14	Dense traffic
15	Traffic jam
16	Narrow lanes
17	Open list

No.	Explanation
18	Closed list
19	Shopping centre
20	Toll road
21	Tourist information
22	Sight
23	Sport & leisure
24	Going out
25	Museum
26	Car rental
27	Travel information
28	Leisure activity
29	Provision of services
30	Cash machine
31	Bus station
32	Camp site



33



41



49



57



34



42



50



58



35



43



51



59



36



44



52



60



37



45



53



61



38



46



54



62



39



47



55



63



40



48



56

No.	Explanation
33	Chemist
34	Cinema
35	Airport
36	Amusement park
37	City
38	Bank
39	Traffic message
40	Ferry
41	Border
42	Tunnel
43	Kiosk
44	Grocery
45	Hotel/motel
46	Motorway exit
47	Car park
48	Park & ride
49	Multi-storey car park

No.	Explanation
50	Petrol station
51	Service area
52	Restaurant
53	WC
54	Historical monument
55	Hospital
56	Emergency
57	Police
58	Harbour
59	Mountain pass
60	Public place
61	Related to the car
62	Garage
63	Cemetery

Voice recognition

General information	84
Phone control	84

General information

The speech recognition of the Phone portal enables you to operate several functions of the mobile phone via voice input. It recognises commands and numeric sequences independently of the relevant speaker. The commands and numeric sequences can be spoken without a voice pause between the individual words.

You can also save telephone numbers using a name of your choice (voice tag). The telephone connection can be set up using this name.

In the event of incorrect operation or incorrect codes the speech recognition gives you acoustic feedback and requests you to re-enter the desired command. Apart from this, the speech recognition acknowledges important commands and will enquire if necessary.

To ensure that conversations inside the vehicle do not lead to unintentional triggering of the mobile phone, the speech recognition does not start until it has been activated.

Phone control

Activating speech recognition

To activate the speech recognition of the Phone portal press the button  on the steering wheel. For the duration of the dialogue any active audio source is muted and any traffic news fade-in is cancelled.

Adjusting the volume for voice output

Turn the volume knob on the Infotainment system or press the + or – button on the steering wheel.

Cancelling the dialogue

There are various possibilities of deactivating the speech recognition and cancelling the dialogue:

- Press the button  on the steering wheel.
- Say "Cancel".
- Do not enter any commands for some time.
- After the third unrecognised command.

Operation

With the aid of the speech recognition the mobile phone can be operated very conveniently via voice input. It is sufficient to activate the speech recognition and to say the desired command. After input of the command the Infotainment system guides you through the dialogue with appropriate questions and feedback to achieve the desired action.

Main commands

After activation of the speech recognition a short tone signals that the speech recognition is expecting input.

Main commands available:

- "Dial"
- "Call"
- "Redialing"
- "Save"
- "Delete"
- "Directory"
- "Pair"

- "Select device"
- "Voice feedback"

Commands that are frequently available

- "Help": the dialogue is terminated and all commands available within the actual function are enumerated.
- "Cancel": the speech recognition is deactivated.
- "Yes": a suitable action is triggered depending on the context.
- "No": a suitable action is triggered depending on the context.

Entering a telephone number

After the command "Dial" the speech recognition requests input of a number.

The telephone number must be spoken in your normal speech without any artificial pauses between the individual numbers.

Recognition works best, if a pause of at least half a second is made after every three to five digits. The Infotainment system then repeats the numbers recognised.

You can then enter further numbers or the following commands:

- "Dial": the inputs are accepted.
- "Delete": the number last entered or the block of numbers last entered is deleted.
- "Plus": a preceding "+" is entered for a call abroad.
- "Verify": the inputs are repeated by the voice output.
- "Star": An asterisk "*" is entered.
- "Hash": A hash "#" is entered.
- "Help"
- "Cancel"

The maximum length of the telephone number entered is 25 digits.

To be able to make a call abroad you can say the word "Plus" (+) at the beginning of your number. The plus allows you to call from any country without knowing the prefix for calls made abroad in that country. Then say the required country code.

Example of a dialogue

User: "Dial"

Voice output: "Please, say the number to dial"

User: "Plus Four Nine"

Voice output: "Plus Four Nine"

User: "Seven Three One"

Voice output: "Seven Three One"

User: "One One Nine Nine"

Voice output: "One One Nine Nine"

User: "Dial"

Voice output: "The number is being dialled"

Entering a name

Using the "Call" command a telephone number is entered that has been stored in the telephone book under a name (voice tag).

Commands available:

- "Yes"
- "No"
- "Help"
- "Cancel"

Example of a dialogue

User: "Call"

Voice output: "Please, say the nametag to call"

User: <Name>

Voice output: "Do you want to call <Michael>?"

User: "Yes"

Voice output: "The number is being dialled"

Starting a second call

A second call can be started during an active telephone call. To do so, press the button ⓧ .

Commands available:

- "Send": activate manual DTMF (touch-tone dialling), e. g. for voice mail or telephone banking.
- "Send nametag": activate DTMF (touch-tone dialling) by entering a name (voice tag).
- "Dial"
- "Call"
- "Redialing"
- "Help"
- "Cancel"

Example of a dialogue

User: <if a telephone call is active: press the ⓧ button>

User: "Send"

Voice output: "Please, say the number to send."

(for number input see the dialogue example for **Entering a telephone number**)

User: "Send"

Redialing

The number last dialled is redialled with the command "Redialing".

Saving

With the command "Save" a telephone number is stored in the telephone book under a name (voice tag).

The name entered must be repeated once. The pitch and pronunciation must be as identical as possible for both name inputs, otherwise the speech recognition will reject the inputs.

A maximum of 50 voice tags can be stored in the telephone book.

Voice tags are speaker-dependent, i. e. only the person who recorded a voice tag can open it.

To avoid the start of the recording of a saved name from being cut off, a short pause should be left after an input request.

To be able to use the voice tag independently of the location, i. e. including other countries, all telephone numbers should be entered with a "plus" character and a country code.

Commands available:

- **"Save"**: the inputs are accepted.
- **"Verify"**: the last input is repeated.
- **"Help"**
- **"Cancel"**

Example of a dialogue

User: **"Save"**

Voice output: **"Please, say the number to save"**

(for number input see the dialogue example for **Entering a telephone number**)

User: **"Save"**

Voice output: **"Please, say the nametag to save"**

User: <Name>

Voice output: **"Please, repeat the nametag to confirm"**

User: <Name>

Voice output: **"Saving the nametag"**

Deleting

A previously saved voice tag is deleted with the command **"Delete"**.

Commands available:

- **"Yes"**
- **"No"**
- **"Help"**
- **"Cancel"**

Listening to stored names

The voice output of all stored names (voice tags) is started with the command **"Directory"**.

Commands available during voice output of the voice tags:

- **"Call"**: the telephone number of the voice tag last read aloud is selected.
- **"Delete"**: the entry of the voice tag last read aloud is deleted.

Saving a mobile phone to or deleting it from the device list

With the command **"Pair"** a mobile phone can be saved to or deleted from the device list of the Phone portal ↻ 93.

Commands available:

- **"Add"**
- **"Delete"**
- **"Help"**
- **"Cancel"**

Example of a dialogue

User: **"Pair"**

Voice output: **"Do you want to add or delete a device?"**

User: **"Add"**

Voice output: "Using the pair function in the external device, enter <1234> to pair."

Voice output: "Do you want to pair the device?"

User: "Yes"

Voice output: "The device is connected as the number <device_number>"

Selecting a mobile phone from the device list

Using the "Select device" command, a mobile phone can be selected in the device list for setting up a Bluetooth connection.

Example of a dialogue

User: "Select device"

Voice output: "Please, say a device number to select"

User: <device_number>

Voice output: "Do you want to select the device number <device_number>?"

User: "Yes"

Voice output: "Do you want to pair the device?"

User: "Yes"

Voice output: "One moment. The system searches for the selected device"

Voice output: "Device number <dev_num> is selected"

Voice feedback

Each voice input is answered or commented on by the Infotainment system by way of a voice output that is adapted to the situation.

To switch the voice output on or off, enter "Voice feedback" or press the button .

Phone

General information 89
 Connection 91
 Bluetooth connection 93
 Emergency call 102
 Operation 102
 Mobile phones and CB radio
 equipment 108

General information

The Phone portal provides you with the possibility of having mobile phone conversations via a vehicle microphone and the vehicle loudspeakers as well as operating the most important mobile phone functions via the Infotainment system in the vehicle. To be able to use the Phone portal, the mobile phone has to be connected with it via Bluetooth.

The Phone portal can be operated optionally via the speech recognition system.

The mobile phone can be operated using an external vehicle antenna by inserting it into an adapter that is specific to the phone.

Not all Phone portal functions are supported by every mobile phone. The possible phone functions depend on the relevant mobile phone and network provider. You will find further information on this in the operating instructions for your mobile phone or you can enquire about them with your network provider.

Important information for operation and traffic safety

⚠ Warning
<p>Mobile phones have effects on your environment. For this reason safety regulations and directions have been prepared. You should be familiar with the related directions before you use the telephone function.</p>

⚠ Warning

Use of the hands-free facility while driving can be dangerous because your concentration is reduced when telephoning. Park your vehicle before you use the hands-free facility. Follow the stipulations of the country in which you find yourself at present.

Do not forget to follow the special regulations that apply in specific areas and always switch off the mobile phone if the use of mobile phones is prohibited, if interference is caused by the mobile phone or if dangerous situations can occur.

Bluetooth

The Phone portal supports Bluetooth Handsfree Profile V. 1.5 and is specified in accordance with the Bluetooth Special Interest Group (SIG).

You will find further information about the specification on the Internet at <http://www.bluetooth.com>. Additionally, the Phone portal supports SIM Access Profile (SAP).

EU R & TTE Compliance

CE 0700

Hereby, we declare that the **Bluetooth System Transceiver** is in compliance with the essential requirements and other relevant provisions of Directive 1999/5/EC.

Operating the speech recognition

Do not use the speech recognition in emergencies, because in stress situations your voice can change so much that it can no longer be recognised sufficiently to set up the desired connection quickly enough.

Base plate for the telephone specific adapter

Keep the contacts of the base plate free from dust and dirt.

Recharging the phone battery

The phone battery is recharged as soon as the Phone portal is switched on and the phone is inserted into the telephone specific adapter.

Control elements

The most important telephone specific control elements are as follows:

PHONE button: opens the telephone main menu.

Controls on steering wheel:

☎, 🗨: take call, activate speech recognition.

📞, 🚫: end/reject call, deactivate speech recognition.

The Phone portal can be operated optionally via speech recognition ↗ 84.

Connection

The Phone portal switches itself on and off via the ignition. When the ignition is turned off you can turn the Phone portal on and off via the Infotainment system.

A connection can be set up between the mobile phone and the Phone portal via Bluetooth. For this purpose your mobile phone must support Bluetooth.

To be able to set up a Bluetooth connection the Phone portal must be switched on and Bluetooth must be activated.

For information on the Bluetooth function of your mobile phone please refer to the operating instructions for the mobile phone.

Telephone specific adapters

If you are using a telephone specific adapter, the mobile phone is operated via the external antenna. The adapter also serves as a charging station.

Use only adapters that are approved for your vehicle and your mobile phone.

Mobile phones with connection interface on the bottom edge Installing the adapter

Fasten the adapter to the base plate.

Make sure that the contacts are correctly connected.

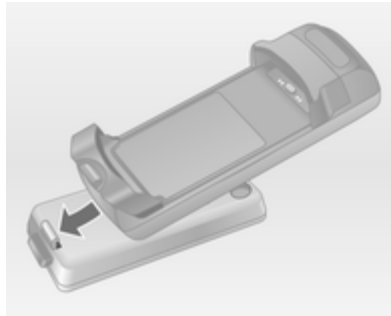

First, lower the front side of the adapter as shown in the above figure.

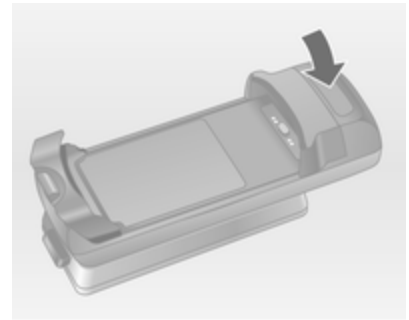

Then lower the back side.

An engaging sound must be audible when the adapter is fastened.

To remove, press the unlocking button on the base plate and lift the back side of the adapter.

Inserting the mobile phone

Insert the mobile phone into the adapter. Make sure that the contacts are correctly connected.



Lower the bottom edge first, as shown in the above figure.

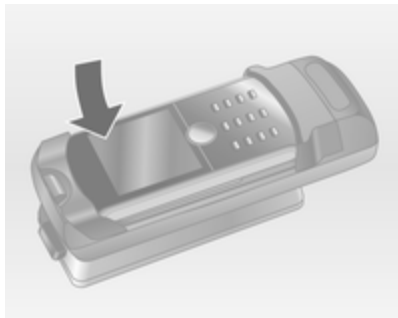

Then lower the top edge. An engaging sound must be audible when the mobile phone engages.

To remove, press the unlocking button on the adapter and lift the top edge of the phone first.

Mobile phones with connection interface on the lateral edge
Installing the adapter

Fasten the adapter to the base plate. Make sure that the contacts are correctly connected.

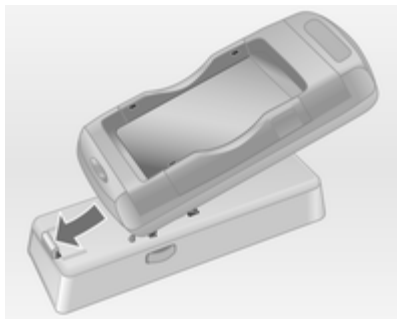

First, lower the front side of the adapter as shown in the above figure.

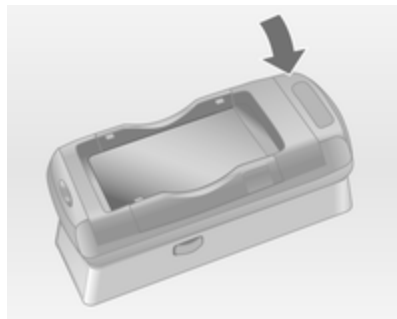

Then lower the back side.

An engaging sound must be audible when the adapter engages.

To remove, simultaneously press the unlocking buttons on both sides of the base plate.

Inserting the mobile phone

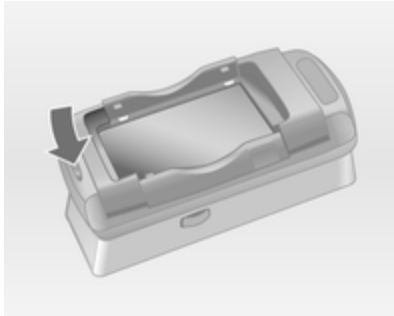

If the side brackets on the adapter are in the closed position, press the button near the front edge of the adapter to open the brackets.



With side brackets of the adapter opened, vertically lower the mobile phone into the adapter as shown in the above figure until the side brackets snap in.

An engaging sound must be audible when the mobile phone engages.

To remove the mobile phone, press the unlocking button on the adapter and lift the mobile phone.

Bluetooth connection

Bluetooth is a radio standard for the wireless connection of, for example, a telephone with other devices.

Information such as a telephone book, call lists, the network operator's name and field strength can be transferred. The functionality can be restricted depending on the telephone type.

To be able to set up a Bluetooth connection with the Phone portal, the Bluetooth function of the mobile phone has to be activated and the mobile phone has to be set to "visible". For further information please refer to the operating instructions for the mobile phone.

CD 500 / DVD 800

Bluetooth menu

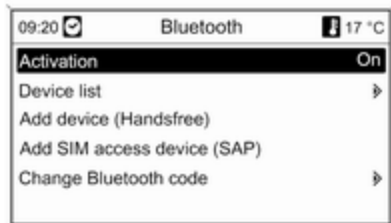

Press **CONFIG** button.

Select **Phone settings** and then **Bluetooth**.

Activating Bluetooth

If the Bluetooth function of the Phone portal is deactivated:

Set **Activation** to **On** and confirm the subsequent message.

Device list

When a mobile phone is connected to the Phone portal via Bluetooth for the first time, the mobile phone is saved in the device list.

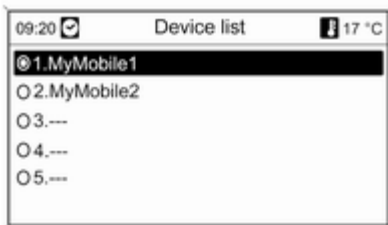

A maximum of 5 mobile phones can be saved in the device list.

Connecting a mobile phone for the first time

There are two options for connecting a mobile phone to the Phone portal: by adding it as a handsfree device or by using the SIM Access Profile (SAP).

Handsfree mode

When the mobile phone is added as a handsfree device the user can make or receive calls and use other functions via the Phone portal. The range of functions available depends on the mobile phone. While it is connected with the Phone portal the mobile phone can be operated as usual.

Note that the mobile phone battery may discharge at a higher speed than usual due to the Bluetooth connection active along with normal operation of the mobile phone.

SAP mode

When using the SAP option, a wider range of functions is available via the Phone portal such as various security and messaging options. The actual range of functions depends on the network provider. Additionally, in the SAP mode the mobile phone is in the standby mode. Only the Bluetooth connection and the SIM card are active, which leads to lower energy consumption of the connected mobile phone.

Connecting a mobile phone as a handsfree device



Select **Add device (Handsfree)**. The Bluetooth code to be entered into the mobile phone is displayed.

The Phone portal can now be detected by other Bluetooth devices.

As soon as the mobile phone has detected the Phone portal the Bluetooth code can be entered on the mobile phone.

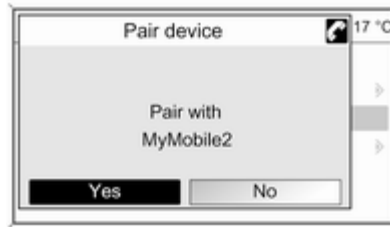

As soon as the Phone portal has detected the mobile phone, the connection set-up can be confirmed. The mobile phone is adopted in the device list and can be operated via the Phone portal.

Changing the Bluetooth code (only relevant for handsfree mode)

The first time a Bluetooth connection to the Phone portal is set up, a default code is displayed. This default code can be changed at any time. For security reasons a four-digit and randomly selected code must be used for pairing devices.

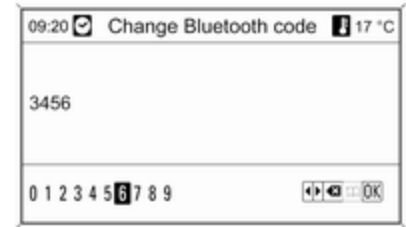

Select **Change Bluetooth code**. On the menu displayed, edit the actual Bluetooth code and accept the modified code using **OK**.

Connecting a mobile phone via SIM Access Profile (SAP)

Select **Add SIM access device (SAP)**. The mobile portal scans for available devices and displays a list of devices found.

Notice

The mobile phone must have Bluetooth activated and be set to visible.

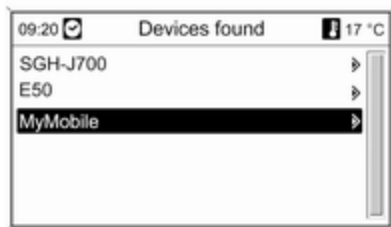

Select the desired mobile phone from the list. The SAP passcode prompt is shown on the Infotainment display containing a 16-digit code.



Enter the displayed SAP passcode in the mobile phone (without spaces). The mobile phone PIN code is shown on the Infotainment display.

If the **PIN request** function is active, the user will have to enter the PIN code of the SIM card in the mobile phone.

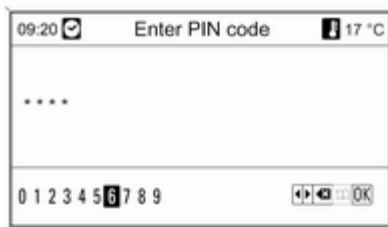

Enter the PIN code of the mobile phone SIM. The mobile phone is paired with the Phone portal. Services of the mobile network provider can be used via the Phone portal.

Connecting a mobile phone saved in the device list

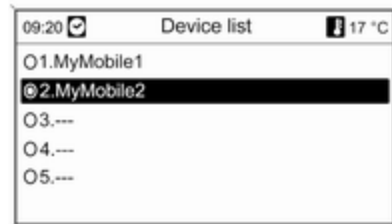

Select the desired mobile phone and then select the option **Select** in the menu displayed.

As soon as the Phone portal has detected the mobile phone, the connection setup can be confirmed.

The mobile phone can be operated via the Phone portal.

Removing a mobile phone from the device list

Select the desired mobile phone from the device list. In the menu displayed select **Delete** and confirm the subsequent message.

Adjusting the ring tone

To change the ring tone characteristic:

Press **CONFIG** button.

Select **Phone settings** and then **Ringtone**.

Select the desired option.

To change the ring tone volume:

While the phone rings turn the \odot knob of the Infotainment system or press the buttons **+ / -** on the steering wheel.

Setting up a connected phone

Various mobile phone settings can be configured in the **Phone settings** menu, if the phone is connected via SAP.

Changing security settings

Press **CONFIG** button.

Select **Phone settings** and then **Security**.

The security dialogue is displayed.

Activating/Deactivating PIN request

Select **PIN request On** or **Off**.

Enter the PIN code of the mobile phone SIM card and confirm.

Notice

This option depends on the individual network provider.

Changing the PIN code

Select **Change PIN**.

Enter the current PIN code. Enter the new PIN code. Repeat the new PIN code and confirm. The PIN has been changed.

Configuring network services

Select **Phone settings** and then **Network services**. The Network services dialogue is displayed.

Depending on the network provider and the mobile phone several options are available.

- **Network selection:** choose between automatic or manual network selection.
- **Call waiting:** activate or deactivate call waiting.

- **Call diverting:** select diverting options depending on the situation.
- **Call barring:** configure call barring options depending on the situation.

For details on network services configuration refer to the mobile phone manual or enquire with the mobile network provider.

Configuring SMS centre number

The SMS centre number is a phone number that acts as a gateway for transferring SMS messages between mobile phones. This number is usually preset by the network provider.

To configure the SMS centre number select **Phone settings** and then **SMS center number**. If required, modify the SMS centre number.

Resetting the mobile phone to factory settings

Select **Phone settings** and then **Factory settings**.

CD 300 / CD 400

Bluetooth menu

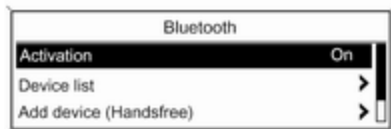

Press the **CONFIG** button.

Select **Phone settings** and then **Bluetooth**.

Activating Bluetooth

If the Bluetooth function of the Phone portal is deactivated: set **Activation** to **On** and confirm the subsequent message.

Device list

When a mobile phone is connected to the Phone portal via Bluetooth for the first time, the mobile phone is stored in the device list.

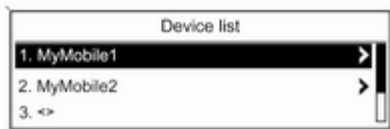

A maximum of 5 mobile phones can be stored in the device list.

Connecting a mobile phone for the first time

There are two options for connecting a mobile phone to the Phone portal: by adding it as a handsfree device or by using the SIM Access Profile (SAP).

Handsfree mode

When the mobile phone is added as a handsfree device the user can make or receive calls and use other functions via the Phone portal. The range of functions available depends on the mobile phone. While it is connected with the Phone portal the mobile phone can be operated as usual. Note that the mobile phone battery may discharge at a higher speed than usual due to the Bluetooth connection active along with normal operation of the mobile phone.

SAP mode

When using the SAP option, a wider range of functions is available via the Phone portal such as various security and messaging options. The actual range of functions depends on the network provider. Additionally, in the SAP mode the mobile phone is in the standby mode. Only the Bluetooth connection and the SIM card are active, which leads to lower energy consumption of the connected mobile phone.

Connecting a mobile phone as a handsfree device

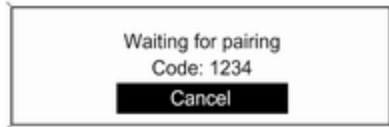

Select **Add device (Handsfree)**. The Bluetooth code to be entered into the mobile phone is displayed.

The Phone portal can now be detected by other Bluetooth devices.

As soon as the mobile phone has detected the Phone portal the Bluetooth code can be entered into the mobile phone.



As soon as the Phone portal has detected the mobile phone, the connection set-up can be confirmed. The mobile phone is adopted in the device list and can be operated via the Phone portal.

Changing the Bluetooth code (only relevant for handsfree mode)

The first time a Bluetooth connection to the Phone portal is set up, a default code is displayed. This default code can be changed at any time. For security reasons a four-digit and randomly selected code must be used for pairing devices.

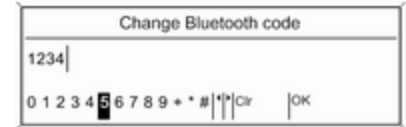

Select **Change Bluetooth code**. On the menu displayed, edit the actual Bluetooth code and accept the modified code using **OK**.

Connecting a mobile phone via SIM Access Profile (SAP) (only CD 400)

Select **Add SIM access device**.

The Phone portal scans for available devices and displays a list of devices found.

Notice

The mobile phone must have Bluetooth activated and be set to visible.

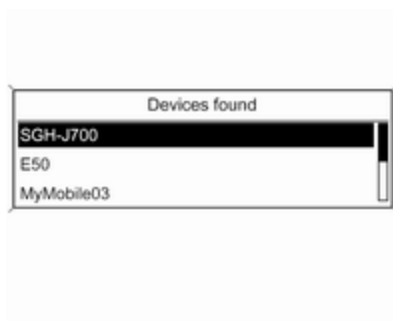

Select the desired mobile phone from the list. The SAP passcode prompt is shown on the Infotainment display containing a 16-digit code.



Enter the displayed SAP passcode in the mobile phone (without spaces). The mobile phone PIN code is shown on the Infotainment display.

If the **PIN request** function is active, the user will have to enter the PIN code of the SIM card in the mobile phone.

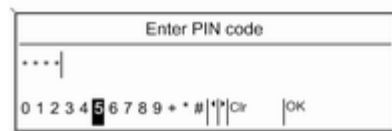

Enter the PIN code of the mobile phone SIM. The mobile phone is paired with the Phone portal. Services of the mobile network provider can be used via the Phone portal.

Connecting a mobile phone saved in the device list

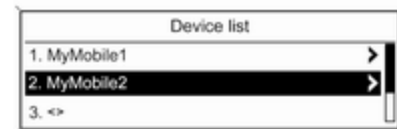

Select the desired mobile phone and then select the option **Select** in the menu displayed.

As soon as the Phone portal has detected the mobile phone, the connection setup can be confirmed.

The mobile phone can be operated via the Phone portal.

Removing mobile phone from device list

Select the desired mobile phone from the device list. In the menu displayed select **Delete** and confirm the subsequent message.

Adjusting the ring tone

To change the ring tone characteristic:

Press **CONFIG** button.

Select **Phone settings** and then **Ring tone**.

Select the desired option.

To change the ring tone volume:

While the phone rings turn the \odot knob of the Infotainment system or press the buttons **+ / -** on the steering wheel.

Setting up a connected phone

Various mobile phone settings can be configured in the **Phone settings** menu, if the phone is connected via SAP.

Changing security settings

Press **CONFIG** button.

Select **Phone settings** and then **Security**.

The security dialogue is displayed.

Activating/Deactivating PIN request

Select **PIN request On** or **Off**.

Enter the PIN code of the mobile phone SIM card and confirm.

Notice

This option depends on the individual network provider.

Changing the PIN code

Select **Change PIN**.

Enter the current PIN code. Enter the new PIN code. Repeat the new PIN code and confirm. The PIN has been changed.

Configuring network services

Select **Phone settings** and then **Network services**. The Network services dialogue is displayed.

Depending on the network provider and mobile phone there are several options available.

- **Network selection:** choose between automatic or manual network selection.
- **Call waiting:** activate or deactivate call waiting.

- **Call diverting:** select diverting options depending on the situation.
- **Call barring:** configure call barring options depending on the situation.

For details on network services configuration refer to the mobile phone manual or enquire with the mobile network provider.

Configuring SMS centre number

The SMS centre number is a phone number that acts as a gateway for transferring SMS messages between mobile phones. This number is usually preset by the network provider.

To configure the SMS centre number select **Phone settings** and then **SMS centre number**. If required, modify the SMS centre number.

Resetting the mobile phone to factory settings

Select **Phone settings** and then **Restore factory settings**.

Emergency call

⚠ Warning

Connection setup cannot be guaranteed in all situations. For this reason you should not rely exclusively on a mobile phone when a vitally important communication (e. g. a medical emergency) is concerned.

In some networks it may be necessary for a valid SIM card to be properly inserted in the mobile phone.

⚠ Warning

Bear in mind that you can make and receive calls with the mobile phone, if it is in a service area with a sufficiently strong signal. Under certain circumstances emergency calls cannot be made on all mobile phone networks; it is possible that they cannot be made when certain network services and/or telephone functions are active. You can enquire about this with the local network operators.

The emergency call number can differ depending on the region and country. Please enquire beforehand about the correct emergency call number for the relevant region.

Making an emergency call

Dial the emergency call number (e. g. 112).

The telephone connection to the emergency call centre is set up.

Answer when the service personnel questions you about the emergency.

⚠ Warning

Do not end the call until you are requested to do so by the emergency call centre.

Operation

Introduction

As soon as a connection via Bluetooth has been set up between your mobile phone and the Infotainment system, you can also operate many functions of your mobile phone via the Infotainment system.

Via the Infotainment system, you can, e. g., set up a connection to the telephone numbers stored in your mobile phone or change the telephone numbers.

Notice

In the handsfree mode mobile phone operation continues to be possible, e. g. taking a call or adjusting the volume.

After setup of a connection between the mobile phone and the Infotainment system the mobile phone data is transmitted to the Infotainment system. This can take some time depending on the phone model. During this period operation of the mobile phone is possible via the Infotainment system only to a limited extent.

Not every telephone supports all functions of the Phone portal. Therefore deviations from the range of functions described with these specific telephones are possible. For further information please refer to the instructions for the telephone specific adapter.

CD 500 / DVD 800**Setting the volume for hands-free facility**

Turn the  knob of the Infotainment system or press the buttons + / - on the steering wheel.

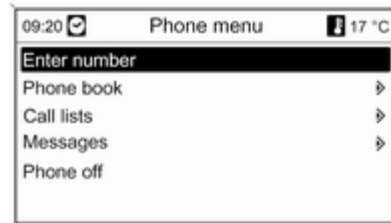
Dialling a telephone number

With the telephone main menu active, press the multifunction knob to open the **Phone menu**.

Several options for dialling telephone numbers, for using the phone book and call lists, for viewing and editing messages are available.

Using the **Phone off** command the connected phone can be detached from the Phone portal.

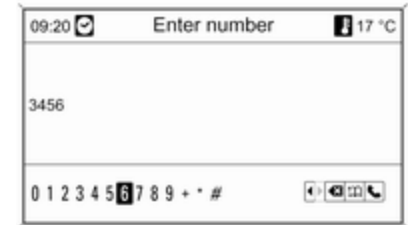
Entering a number manually

Select **Enter number**, then enter the desired number sequence.

To start the dialling process, select .

To open the telephone book menu, select .

Telephone book

After setting up the connection the telephone book is compared with the telephone book in the temporary memory, provided that the same SIM

card or same telephone is concerned. During this period any newly added entries are not displayed.

If the SIM card or telephone are different, the telephone book is reloaded. This process can take a few minutes depending on the phone model.

Selecting a telephone number from the telephone book

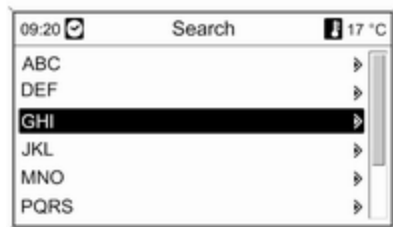

Select **Phone book**.

On the **Search** menu displayed, select the desired first letter range to start a preselection of the telephone book entries that you want to have displayed.

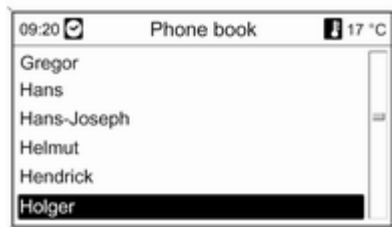

Notice

Telephone book entries are carried over as they are transferred from the mobile phone. The presentation and order of the telephone book entries may be different on the Infotainment system's display and the mobile phone's display.

After having performed the preselection: select the desired entry in the telephone book to display the numbers saved under this entry.

Select the desired number to start the dialling process.

Call lists

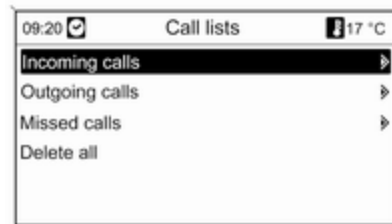

Via the menu **Call lists** the incoming, outgoing and missed calls can be viewed and the relevant numbers can be dialled. The lists can also be deleted in this menu.

To start a dialling process: select the desired call list, an entry in the call list and finally the desired telephone number.

Messaging functions

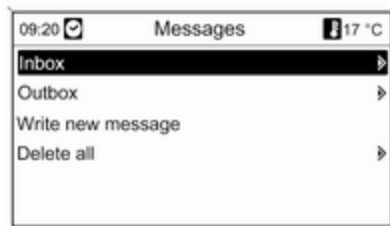

When the mobile phone is paired using the SAP mode, messages can be viewed, composed and sent via the Phone portal. The messages can also be deleted in this menu.

To view received messages: select **Inbox**.

To view sent messages: select **Outbox**.

To compose a message: select **Write new message**.

Notice

Messages are limited to 70 characters.

Incoming call

When there is an incoming call a menu is displayed for you to accept or decline the telephone call.

Select the required option.

Functions during a telephone call

If you are currently making a telephone call, press the multifunction knob to open a submenu.

Various options are available depending on the situation and range of functions of the mobile phone:

- **Hang up:** disconnect the telephone connection.
- **Call number:** enter a telephone number to make a second telephone call or perform DTMF (touch-tone dialling), e. g. for voice mail or telephone banking.

- **Detach call:** detach the connection to a conference participant in a telephone conference.
- **Merge calls:** merge two calls when there are several active calls.
- **Switch calls:** switch between calls, if there are several calls.
- **Mute call:** mute a call.

Notice

If the ignition is turned off during a telephone call the connection remains active until the telephone call is terminated.

CD 300 / CD 400

Setting the volume for hands-free facility

Turn the \odot knob of the Infotainment system or press the buttons + / - on the steering wheel.

Dialling a telephone number



With the telephone main menu active, press the multifunction knob to open the phone operation menu.

Several options for dialling telephone numbers, for using the phone book and call lists, for viewing and editing messages are available.

Using the **Phone off** command the connected phone can be detached from the Phone portal.

Entering a number manually

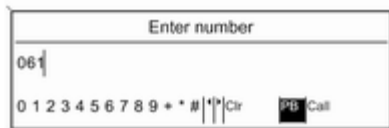

Select **Enter number** and then enter the desired number sequence.

Select **Call** to start the dialling process.

You can switch to the telephone book menu by selecting **PB**.

Telephone book

After setting up the connection the telephone book is compared with the telephone book in the temporary memory, provided that the same SIM card or same telephone is concerned. During this period any newly added entries are not displayed.

If the SIM card or telephone are different, the telephone book is reloaded. This process can take a few minutes depending on the phone model.

Selecting a telephone number from the telephone book

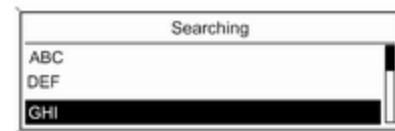

Select **Phone book**. In the displayed menu select the desired first letter range to start a preselection of the telephone book entries that you want to have displayed.

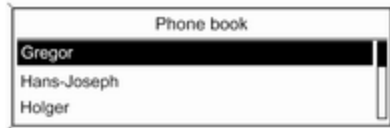

Notice

Telephone book entries are carried over as they are transferred from the mobile phone. The presentation and order of the telephone book entries may be different on the Infotainment system's display and the mobile phone's display.

After having performed the preselection: select the desired entry in the telephone book to display the numbers saved under this entry.

Select the desired number to start the dialling process.

Call lists

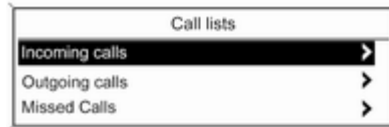

Via the menu **Call lists** the user can view incoming, outgoing and missed calls and dial the relevant numbers. To start a dialling process: select the desired call list, an entry in the call list and finally the desired telephone number.

Messaging functions (only CD 400)

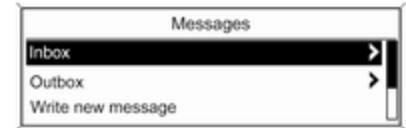

When the mobile phone is paired using the SAP mode, the user can view, compose and send messages via the Phone portal. The messages can also be deleted in this menu.

To view received messages: select **Inbox**.

To view sent messages: select **Outbox**.

To compose a message: select **Write new message**.

Notice

Messages are limited to 70 characters.

Incoming call

When there is an incoming call a menu is displayed to accept or decline the telephone call.

Select required option.

Functions during a telephone call

If you currently have a telephone call, press the multifunction knob to open a submenu.

Various options are available depending on the situation and range of functions of the mobile phone:

- **Hang up:** disconnect the telephone connection.
- **Call number:** enter a telephone number to make a second telephone call or perform DTMF (touch-tone dialling), e.g. for voice mail or telephone banking.
- **Detach call:** detach the connection to a conference participant in a telephone conference.
- **Merge calls:** merge two calls when there are several active calls.

- **Switch calls:** switch between calls, if there are several calls.
- **Mute call:** mute a call.

Mobile phones and CB radio equipment

Installation instructions and operating guidelines

The vehicle specific installation instructions and the operating guidelines of the mobile phone and handsfree manufacturer must be observed when installing and operating a mobile telephone. Failure to do so could invalidate the vehicle type approval (EU directive 95/54/EC).

Recommendations for fault-free operation:

- Professionally installed exterior antenna to obtain the maximum range possible,
- Maximum transmission power 10 watts,

- Installation of the phone in a suitable spot, consider relevant Note in the Owner's manual, chapter **Airbag system**.

Seek advice on predetermined installation points for the external antenna or equipment holder and ways of using devices with a transmission power exceeding 10 watts.

Use of a handsfree attachment without external antenna with mobile telephone standards GSM 900/1800/1900 and UMTS is only permitted if the maximum transmission power of the mobile telephone is 2 watts for GSM 900 or 1 watt for the other types.

For reasons of safety, do not use the phone while driving. Even use of a handsfree set can be a distraction while driving.

⚠ Warning

Operation of radio equipment and mobile telephones which fail to meet above mentioned mobile telephone standards is only permitted using an antenna located outside of the vehicle.

Caution

Mobile telephones and radio equipment may lead to malfunctions in the vehicle electronics when operated inside the vehicle with no exterior antenna, unless the above mentioned regulations are observed.

Index

- | | | | |
|------------------------------------|----|----------------------------------|-----|
| A | | Digital audio broadcasting | 37 |
| Activating CD/DVD player..... | 42 | Dynamic guidance | 78 |
| Activating speech recognition..... | 84 | E | |
| Activating the navigation system.. | 55 | Emergency call | 102 |
| Activating the radio..... | 24 | Enhanced Other Networks..... | 33 |
| Autostore lists | 25 | EON..... | 33 |
| AUX input | | F | |
| socket | 46 | Favourite lists | 26 |
| usage | 46 | G | |
| B | | General information | |
| BACK button..... | 12 | 2, 40, 46, 48, 53, 84, 89 | |
| Basic operation | 12 | Guidance | 71 |
| Bluetooth..... | 89 | H | |
| Bluetooth connection | 93 | Handsfree mode..... | 93 |
| C | | Home address..... | 55 |
| CD/DVD player | | I | |
| activating | 42 | Infotainment system | |
| important information | 40 | control elements | 5 |
| usage | 42 | instrument panel | 5 |
| Configuring DAB..... | 37 | maximum startup volume | 21 |
| Configuring RDS..... | 33 | Multifunction unit | 5 |
| Connection | 91 | mute | 11 |
| Control elements overview | 5 | personalisation | 23 |
| D | | setting volume | 11 |
| DAB..... | 37 | speed compensated volume | 11 |
| Destination input | 59 | speed dependent volume | 21 |

steering wheel audio controls	5	maps	53	call lists	102
switching on	11	navigation display	55	control elements	89
tone settings	18	navigation options	71	dialling a number	102
usage	11	navigation volume	55	emergency calls	102
volume of the traffic		Points of interest	59	functions during a call	102
announcements	21	repeat last navigation		handsfree mode	93
volume settings	21	message	71	important information	89
M		route blocking	71	messaging functions	102
Menu operation	12	route guidance	71	recharging the battery	89
Mobile phone adapter	91	route list	71	setting the volume	102
Mobile phones and CB radio		start navigation	71	SIM Access Profile (SAP)	93
equipment	108	symbols overview	80	telephone book	102
Multifunction knob	12	TMC messages	71	telephone specific adapter	91
Mute	11	Tours	59	Phone adapter	91
N		Travel guide	59	Phone control	84
Navigation		usage	55	Playing saved audio files	50
activating	55	using the speller function	59	R	
add/remove maps	55	Navigation display	55	Radio	
Address book	69	Navigation maps	53	Radio data system (RDS)	33
control elements	55	Navigation volume	55	activating	24
deleting Home address	55	O		autostore lists	25
destination input	59	Operation	102	Digital audio broadcasting	
dynamic guidance	71, 78	P		(DAB)	37
erase map data memory	55	Personalisation	23	favourite lists	26
fuel level low alert	59	Phone		selecting the waveband	24
functioning	53	adjusting ring tones	93	station lists	28
highway lane guidance	71	Bluetooth	89	station search	24
loadig maps	55	Bluetooth connection	93	usage	24
				waveband menus	28

Radio data system (RDS)	33
RDS.....	33
Recharging the phone battery.....	89
Regionalization.....	33
Retrieving stations.....	25, 26
Route guidance.....	71, 78
S	
SAP mode.....	93
Selecting the waveband.....	24
Setting the navigation volume.....	55
Setting the volume.....	11
SIM Access Profile (SAP).....	93
Speech recognition.....	84
activating	84
phone control	84
usage	84
volume for voice output	84
Speed compensated volume.....	11
Starting CD/DVD replay.....	42
Station search	24
Storing stations.....	25, 26
Switching the Infotainment system on or off.....	11
Switching the radio on.....	24
Symbols overview	80
T	
Telephone specific adapter.....	91
Theft-deterrent feature	3
Tone settings	18
Traffic announcements.....	21
U	
Updating station lists.....	28
Usage	11, 24, 42, 46, 55
USB port	
important information	48
iPod functions	50
playing saved audio files	50
supported iPod models	48
Using the address book	69
Using the AUX input.....	46
Using the CD/DVD player.....	42
Using the Infotainment system.....	11
Using the navigation system.....	55
Using the radio.....	24
Using the USB port.....	48
V	
Volume for voice output.....	84
Volume settings	21
W	
Waveband menus	28